



Inductors for Power Circuits

Multilayer Ferrite

MLP_{series}

MLP1608	1608 [0603 inch]*
MLP2012	2012 [0805 inch]
MLP2016	2016 [0806 inch]
MLP2520	2520 [1008 inch]

* Dimensions Code JIS[EIA]

REMINDERS FOR USING THESE PRODUCTS

Before using these products, be sure to request the delivery specifications.

SAFETY REMINDERS

Please pay sufficient attention to the warnings for safe designing when using these products.

REMINDERS

- The storage period is less than 12 months. Be sure to follow the storage conditions (Temperature: 5 to 40°C, Humidity: 10 to 75% RH or less).
If the storage period elapses, the soldering of the terminal electrodes may deteriorate.
- Do not use or store in locations where there are conditions such as gas corrosion (salt, acid, alkali, etc.).
- Before soldering, be sure to preheat components.
The preheating temperature should be set so that the temperature difference between the solder temperature and chip temperature does not exceed 150°C.
- Soldering corrections after mounting should be within the range of the conditions determined in the specifications.
If overheated, a short circuit, performance deterioration, or lifespan shortening may occur.
- When embedding a printed circuit board where a chip is mounted to a set, be sure that residual stress is not given to the chip due to the overall distortion of the printed circuit board and partial distortion such as at screw tightening portions.
- Self heating (temperature increase) occurs when the power is turned ON, so the tolerance should be sufficient for the set thermal design.
- Carefully lay out the coil for the circuit board design of the non-magnetic shield type.
A malfunction may occur due to magnetic interference.
- Use a wrist band to discharge static electricity in your body through the grounding wire.
- Do not expose the products to magnets or magnetic fields.
- Do not use for a purpose outside of the contents regulated in the delivery specifications.
- The products listed on this catalog are intended for use in general electronic equipment (AV equipment, telecommunications equipment, home appliances, amusement equipment, computer equipment, personal equipment, office equipment, measurement equipment, industrial robots) under a normal operation and use condition.
The products are not designed or warranted to meet the requirements of the applications listed below, whose performance and/or quality require a more stringent level of safety or reliability, or whose failure, malfunction or trouble could cause serious damage to society, person or property.
If you intend to use the products in the applications listed below or if you have special requirements exceeding the range or conditions set forth in the each catalog, please contact us.

- (1) Aerospace/Aviation equipment
- (2) Transportation equipment (cars, electric trains, ships, etc.)
- (3) Medical equipment
- (4) Power-generation control equipment
- (5) Atomic energy-related equipment
- (6) Seabed equipment
- (7) Transportation control equipment

- (8) Public information-processing equipment
- (9) Military equipment
- (10) Electric heating apparatus, burning equipment
- (11) Disaster prevention/crime prevention equipment
- (12) Safety equipment
- (13) Other applications that are not considered general-purpose applications

When designing your equipment even for general-purpose applications, you are kindly requested to take into consideration securing protection circuit/device or providing backup circuits in your equipment.

Inductors for Power Circuits

Multilayer Ferrite

Product compatible with RoHS directive
Halogen-free
Compatible with lead-free solders

Overview of the MLP Series

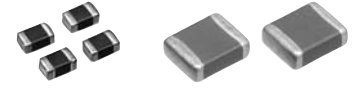

FEATURES

- A low-loss magnetic material is used so that a low-loss inductor for the power supply circuit can be achieved.
- In addition to the inductance value, product types with various features are available so that they can be compatible with different usages.
 - K Type: Products with low DC resistance and large current.
 - H Type: This product uses a low-loss material and has low DC resistance.
 - * Optimal for when heavy load power efficiency is important.
 - V Type: As with the H type, this product with a low-loss magnetic material and that has good DC superimposition type characteristics.
 - * Optimal for when light load power efficiency is important.
 - S Type: STD product lineup that includes a wide L value and various sizes.

APPLICATION

Smart phones, tablet terminals, digital cameras, video cameras, HDDs, power supply modules, etc.

PART NUMBER CONSTRUCTION

MLP	1608	V	R47	B	T	□□□					
Series name	LxW Dimensions (mm)		Characteristic type		Inductance (μH)		Height (mm max.)		Packaging style		Internal code
1608	1.6	0.8	K	Large current, low resistance	1R0	1.0	T	0.55	T	Taping	
2012	2.0	1.25	H	Low core loss (Emphasized DC resistance)	100	10	D	0.75			
2016	2.0	1.6			S1R0S	1.2	B	0.95			
2520	2.5	2.0	V	Low core loss (Emphasized DC bias characteristics)	S2R2S	2.5	M	1.0			
			S	STD product			S	1.2			

OPERATING TEMPERATURE RANGE, PACKAGE QUANTITY, PRODUCT WEIGHT

Type		Temperature range		Package quantity (pieces/reel)	Individual weight (mg)
		Operating temperature*	Storage temperature**		
		(°C)	(°C)		
MLP1608	t=0.75	-40 to +125	-40 to +85	4,000	4
	t=0.95				5.5
MLP2012	t=0.55	-40 to +125	-40 to +85	4,000	7
	t=1.0				10
MLP2016		-40 to +125	-40 to +85	3,000	12
MLP2520	t=1.0	-40 to +125	-40 to +85	3,000	15
	t=1.2				25

* Operating temperature range includes self-temperature rise.

** The Storage temperature range is for after the circuit board is mounted.

- RoHS Directive Compliant Product: See the following for more details related to RoHS Directive compliant products. <http://www.tdk.co.jp/rohs/>
- Halogen-free: Indicates that Cl content is less than 900ppm, Br content is less than 900ppm, and that the total Cl and Br content is less than 1500ppm.

• All specifications are subject to change without notice.

Overview of the MLP Series

RECOMMENDED REFLOW PROFILE

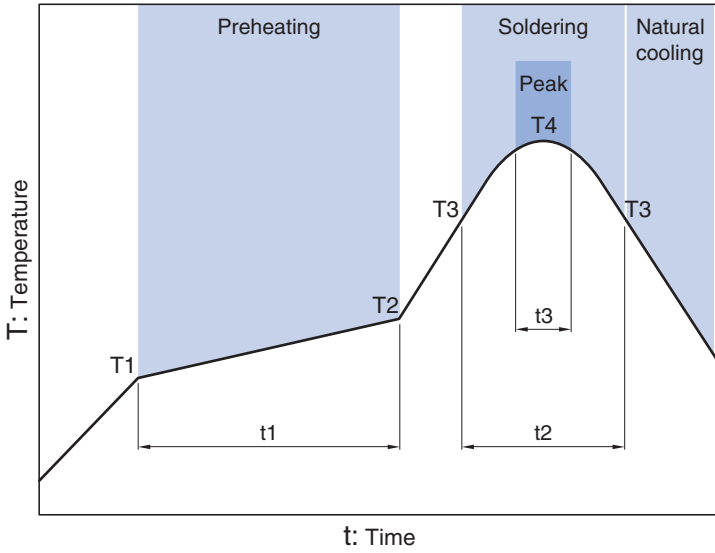

Preheating			Soldering		Peak	
Temp.	Temp.	Time	Temp.	Time	Temp.	Time
T1	T2	t1	T3	t2	T4	t3
150°C	180°C	60 to 120s	230°C	30 to 60s	250 to 260°C	10s max.

• All specifications are subject to change without notice.

MLP_{series}

MLP1608 Type

■ SHAPE & DIMENSIONS

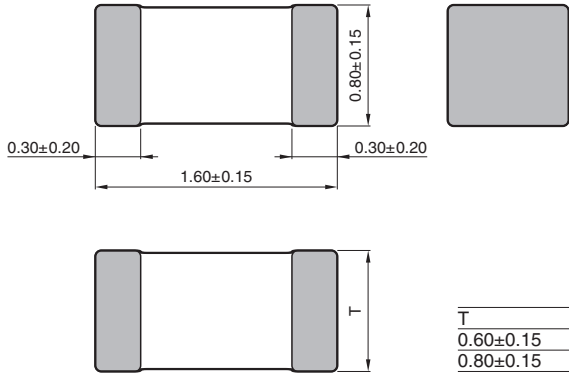

Dimensions in mm

■ RECOMMENDED LAND PATTERN

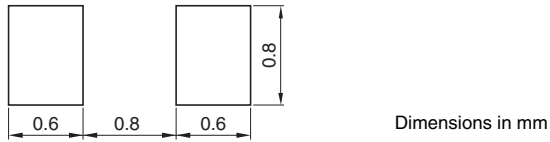

Dimensions in mm

• All specifications are subject to change without notice.

MLP_{series} **MLP1608 Type**

■ ELECTRICAL CHARACTERISTICS

□ CHARACTERISTICS SPECIFICATION TABLE

Type		Thickness T	L		Measuring frequency (MHz)	DC resistance (Ω)±30%	Rated current*	Part No.**
		(mm) max.	(μH)	tolerance			(mA) max.	
Low core loss	Low resistance	0.95	2.2	±20%	2	0.30	750	MLP1608H2R2BT□□□
		0.75	0.47	±20%	2	0.22	800	MLP1608VR47DT□□□
	Emphasized DC bias characteristics	0.75	1.0	±20%	2	0.30	700	MLP1608V1R0DT□□□
		0.95	0.47	±20%	2	0.20	800	MLP1608VR47BT□□□
		0.95	1.0	±20%	2	0.30	700	MLP1608V1R0BT□□□
		0.95	2.2	±20%	2	0.36	600	MLP1608V2R2BT□□□

* Rated current: Current assumed when temperature has risen to 40°C max.

** □□□: Please specify internal code.

○ Measurement equipment

Measurement item	Product No.	Manufacturer
L	4294A+16034G	Agilent Technologies
DC resistance	Type-7561	Yokogawa

* Equivalent measurement equipment may be used.

MLP_{series} **MLP1608Type** (H characteristic product, T dimension of the product 0.95mm max.)

■ ELECTRICAL CHARACTERISTICS

□ L FREQUENCY CHARACTERISTICS GRAPH

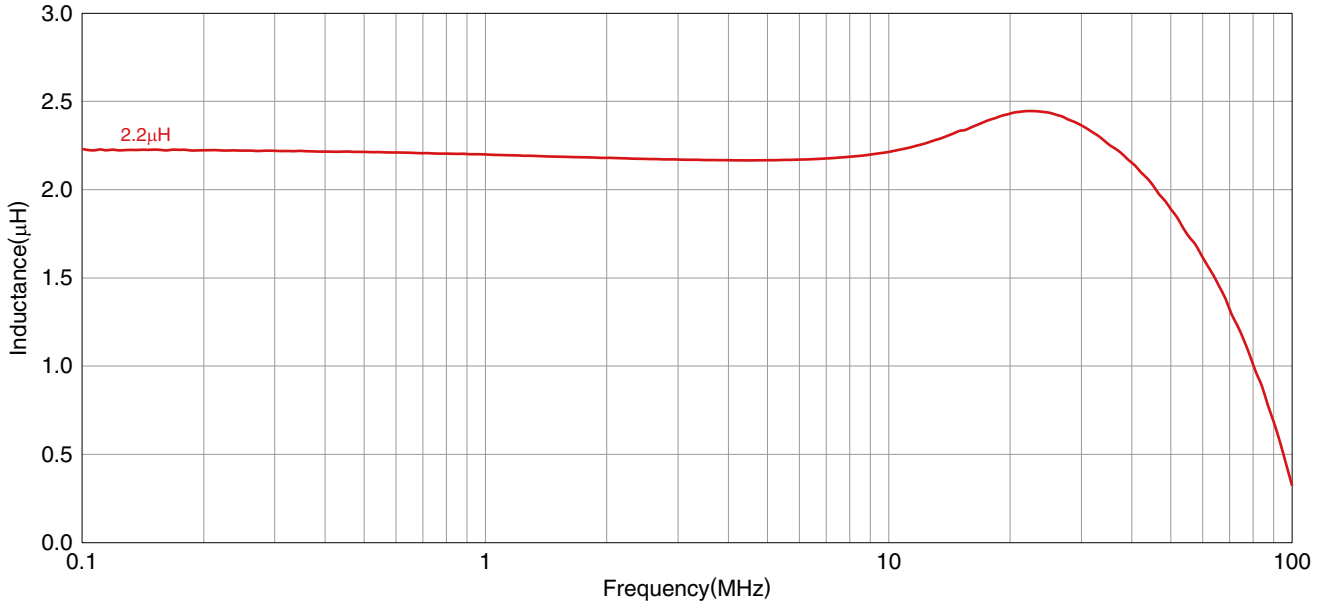

○ Measurement equipment

Product No.	Manufacturer
4294A+16034G	Agilent Technologies

* Equivalent measurement equipment may be used.

MLP_{series} **MLP1608 Type** (H characteristic product, T dimension of the product 0.95mm max.)

■ ELECTRICAL CHARACTERISTICS

□ INDUCTANCE VS. DC BIAS CHARACTERISTICS GRAPH

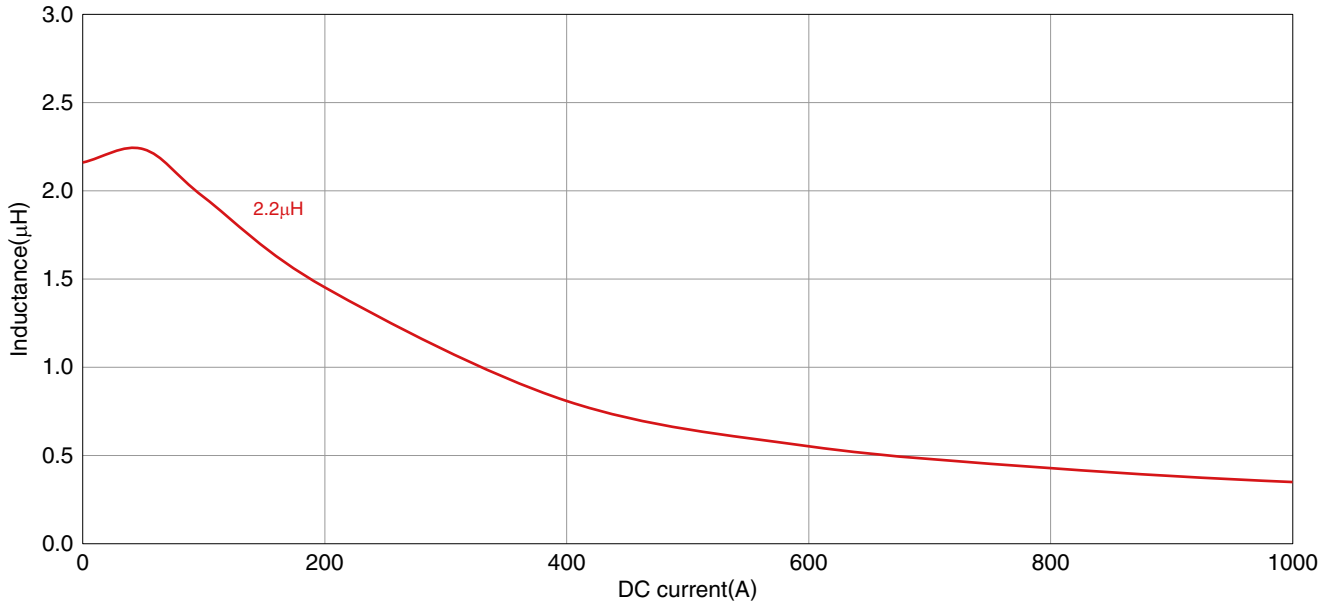

○ Measurement equipment

Product No.	Manufacturer
4285A+42841A+42842C+42851-61100	Agilent Technologies

* Equivalent measurement equipment may be used.

MLP_{series} **MLP1608 Type** (V characteristic product, T dimension of the product 0.75mm max.)

■ ELECTRICAL CHARACTERISTICS

□ L FREQUENCY CHARACTERISTICS GRAPH

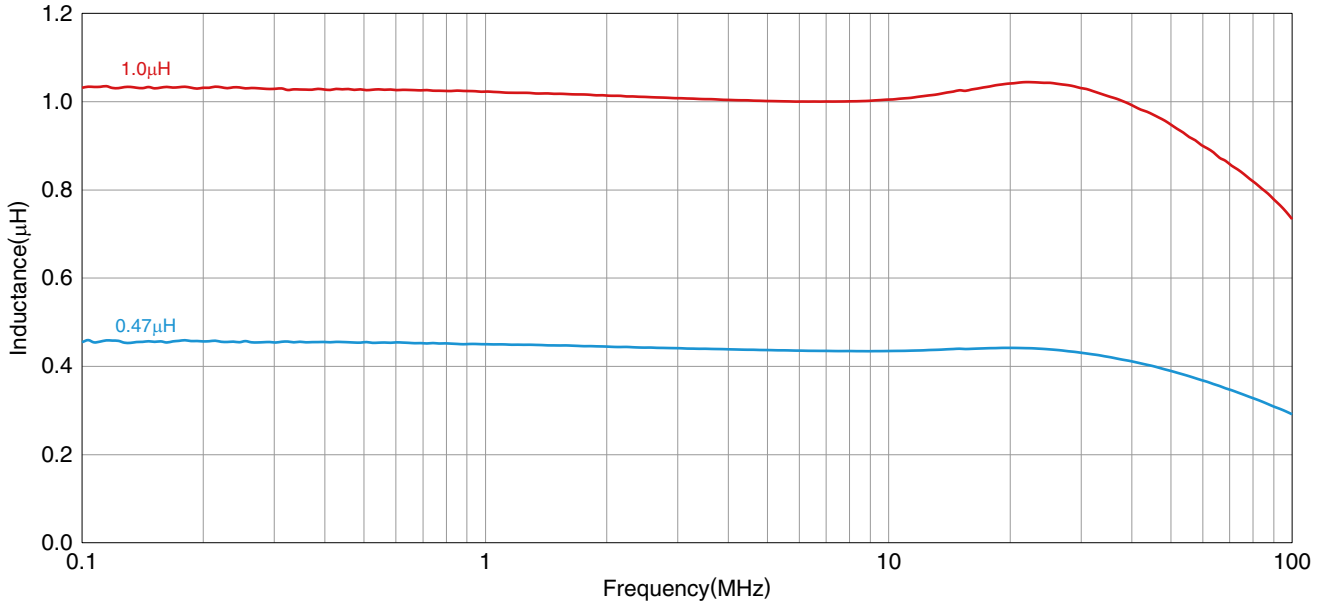

○ Measurement equipment

Product No.	Manufacturer
4294A+16034G	Agilent Technologies

* Equivalent measurement equipment may be used.

MLP_{series} **MLP1608 Type** (V characteristic product, T dimension of the product 0.75mm max.)

■ ELECTRICAL CHARACTERISTICS

□ INDUCTANCE VS. DC BIAS CHARACTERISTICS GRAPH

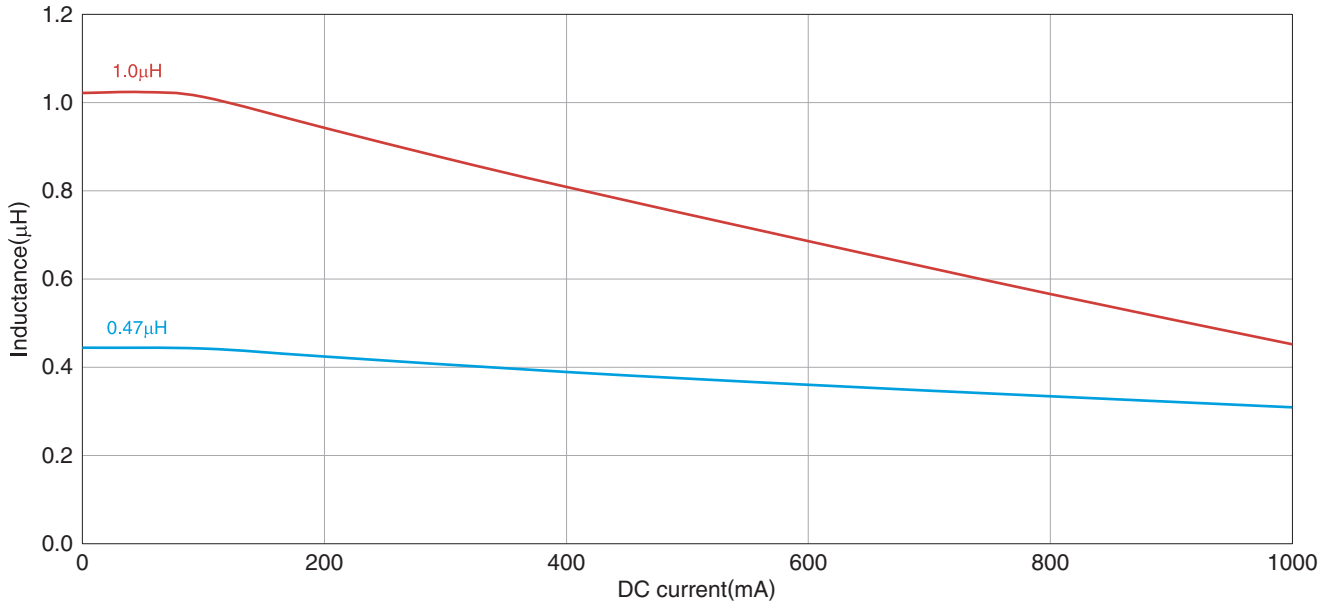

○ Measurement equipment

Product No.	Manufacturer
4285A+42841A+42842C+42851-61100	Agilent Technologies

* Equivalent measurement equipment may be used.

MLP_{series} **MLP1608 Type** (V characteristic product, T dimension of the product 0.95mm max.)

■ ELECTRICAL CHARACTERISTICS

□ L FREQUENCY CHARACTERISTICS GRAPH

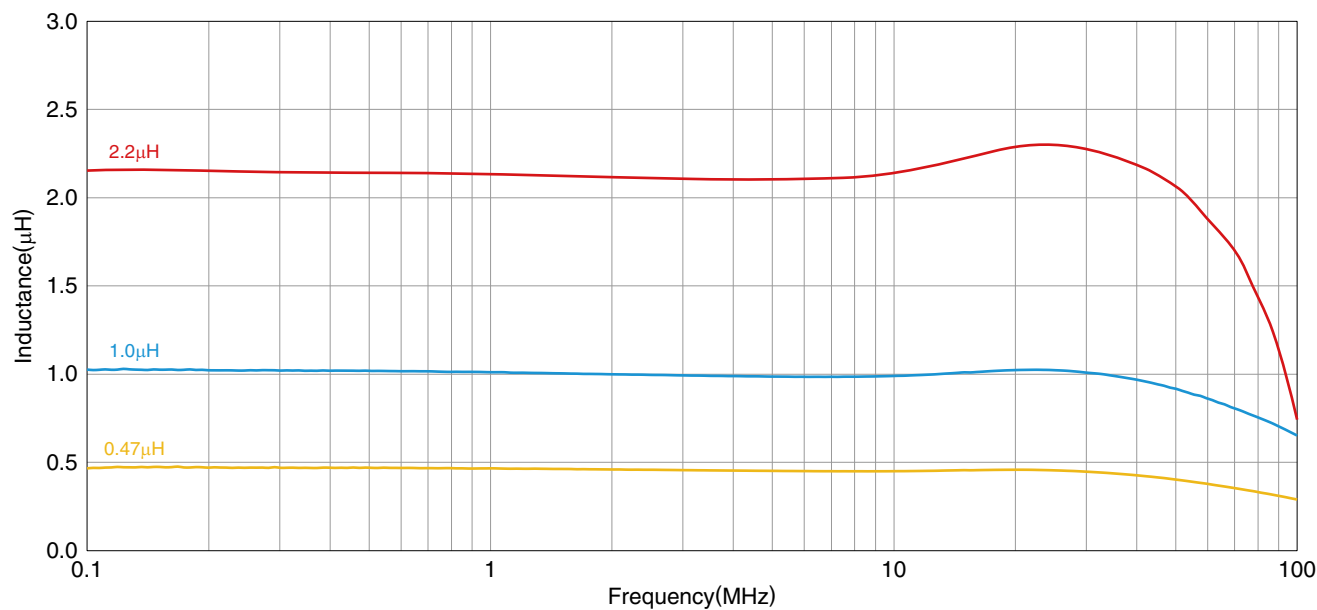

○ Measurement equipment

Product No.	Manufacturer
4294A+16034G	Agilent Technologies

* Equivalent measurement equipment may be used.

MLP_{series} **MLP1608 Type** (V characteristic product, T dimension of the product 0.95mm max.)

■ ELECTRICAL CHARACTERISTICS

□ INDUCTANCE VS. DC BIAS CHARACTERISTICS GRAPH

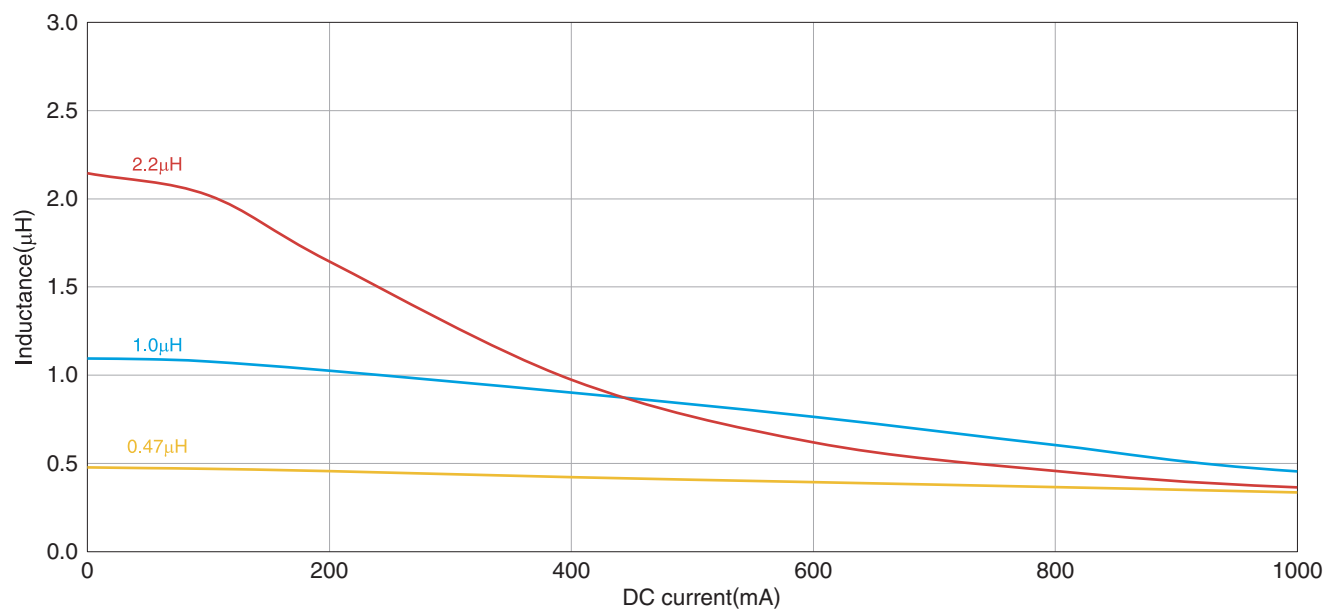

○ Measurement equipment

Product No.	Manufacturer
4285A+42841A+42842C+42851-61100	Agilent Technologies

* Equivalent measurement equipment may be used.

MLP_{series}

MLP2012 Type

■ SHAPE & DIMENSIONS

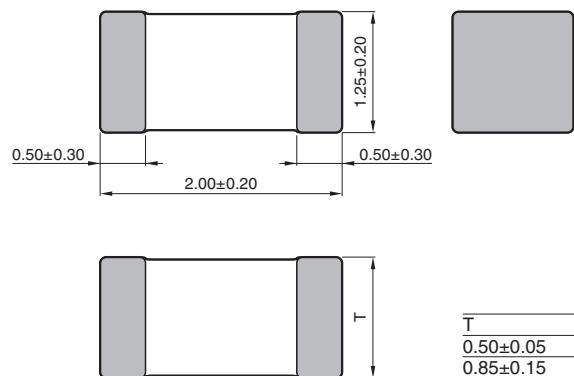

■ RECOMMENDED LAND PATTERN

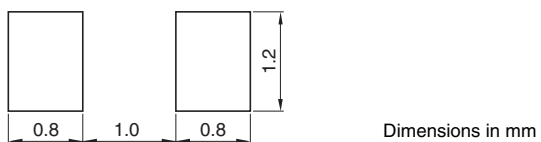

• All specifications are subject to change without notice.

MLP_{series} **MLP2012Type**

■ ELECTRICAL CHARACTERISTICS

□ CHARACTERISTICS SPECIFICATION TABLE

Type	Thickness T (mm)	L (μ H)	tolerance	Measuring frequency (MHz)	DC resistance (Ω) \pm 30%	Rated current* (mA) max.	Part No.**
	max.						
Low resistance	1.0	0.47	\pm 20%	2	0.07	1300	MLP2012HR47MT□□□
	1.0	0.54	\pm 20%	2	0.065	1300	MLP2012HR54MT□□□
	1.0	1.0	\pm 20%	2	0.12	1100	MLP2012H1R0MT□□□
	1.0	1.5	\pm 20%	2	0.12	1100	MLP2012H1R5MT□□□
	1.0	2.2	\pm 20%	2	0.15	1000	MLP2012H2R2MT□□□
Low core loss	0.55	1.0	\pm 20%	2	0.26	700	MLP2012V1R0TT□□□
	1.0	0.47	\pm 20%	2	0.11	1100	MLP2012VR47MT□□□
	1.0	1.0	\pm 20%	2	0.20	900	MLP2012V1R0MT□□□
	1.0	1.5	\pm 20%	2	0.23	800	MLP2012V1R5MT□□□
	1.0	2.2	\pm 20%	2	0.28	700	MLP2012V2R2MT□□□
Emphasized DC bias characteristics	1.0	4.7	\pm 20%	2	0.40	600	MLP2012V4R7MT□□□
	0.55	0.47	\pm 20%	2	0.13	1200	MLP2012SR47TT□□□
	0.55	0.82	\pm 20%	2	0.13	1200	MLP2012SR82TT□□□
	0.55	1.0	\pm 20%	2	0.23	800	MLP2012S1R0TT□□□
	0.55	1.5	\pm 20%	2	0.27	700	MLP2012S1R5TT□□□
	0.55	2.2	\pm 20%	2	0.33	600	MLP2012S2R2TT□□□
	1.0	0.47	\pm 20%	2	0.09	1200	MLP2012SR47MT□□□
	1.0	1.0	\pm 20%	2	0.16	1000	MLP2012S1R0MT□□□
	1.0	1.5	\pm 20%	2	0.16	1000	MLP2012S1R5MT□□□
	1.0	2.2	\pm 20%	2	0.23	800	MLP2012S2R2MT□□□
STD product	1.0	3.3	\pm 20%	2	0.19	900	MLP2012S3R3MT□□□
	1.0	4.7	\pm 20%	2	0.26	700	MLP2012S4R7MT□□□

* Rated current: Current assumed when temperature has risen to 40°C max.

** □□□: Please specify internal code.

○ Measurement equipment

Measurement item	Product No.	Manufacturer
L	4294A+16034G	Agilent Technologies
DC resistance	Type-7561	Yokogawa

* Equivalent measurement equipment may be used.

MLP_{series} **MLP2012 Type** (H characteristic product, T dimension of the product 1.0mm max.)

■ ELECTRICAL CHARACTERISTICS

□ L FREQUENCY CHARACTERISTICS GRAPH

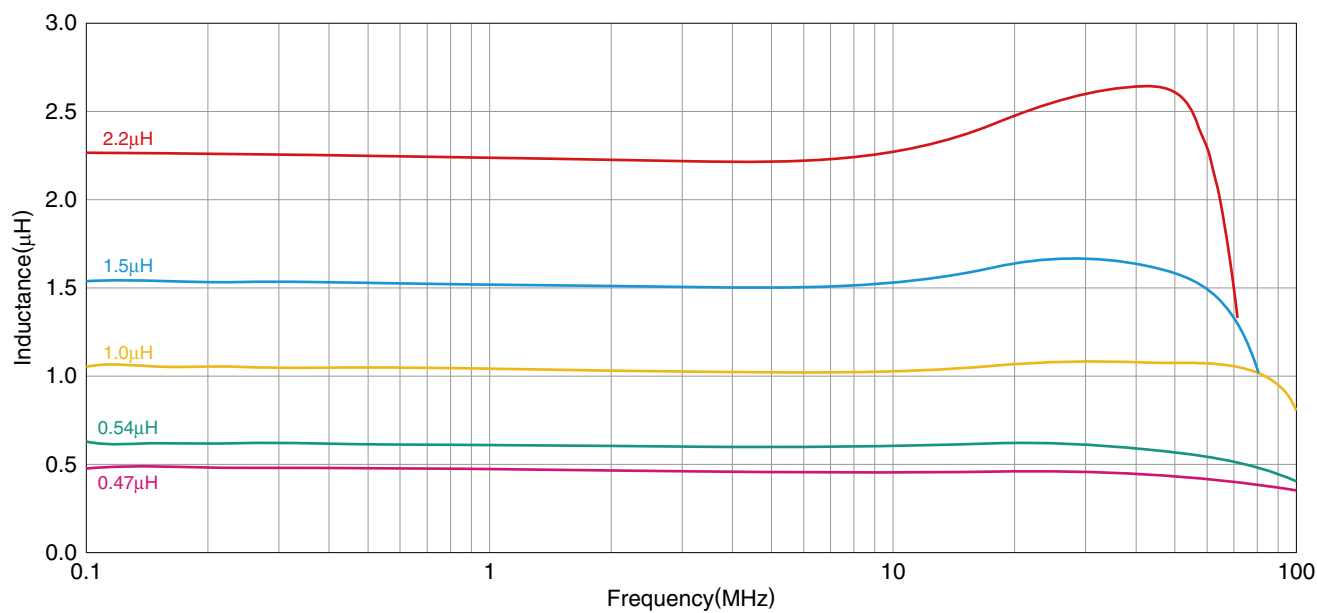

○ Measurement equipment

Product No.	Manufacturer
4294A+16034G	Agilent Technologies

* Equivalent measurement equipment may be used.

MLP_{series} **MLP2012 Type** (H characteristic product, T dimension of the product 1.0mm max.)

■ ELECTRICAL CHARACTERISTICS

□ INDUCTANCE VS. DC BIAS CHARACTERISTICS GRAPH

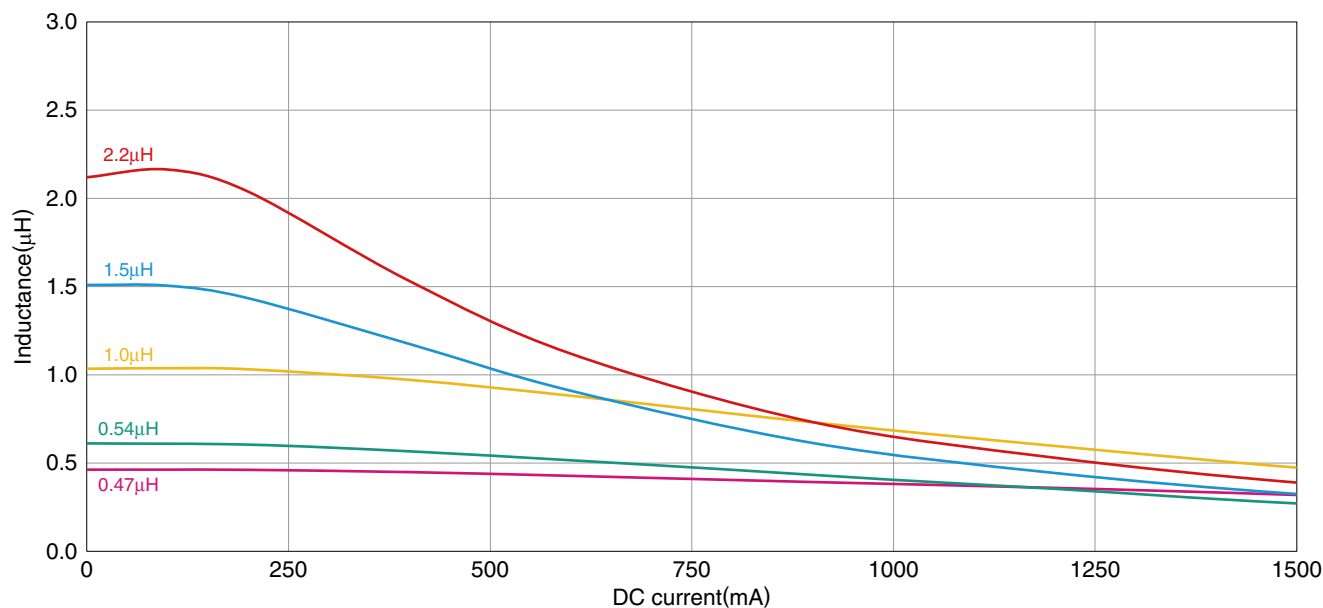

○ Measurement equipment

Product No.	Manufacturer
4285A+42841A+42842C+42851-61100	Agilent Technologies

* Equivalent measurement equipment may be used.

MLP_{series} **MLP2012 Type** (V characteristic product, T dimension of the product 0.55mm max.)

■ ELECTRICAL CHARACTERISTICS

□ L FREQUENCY CHARACTERISTICS GRAPH

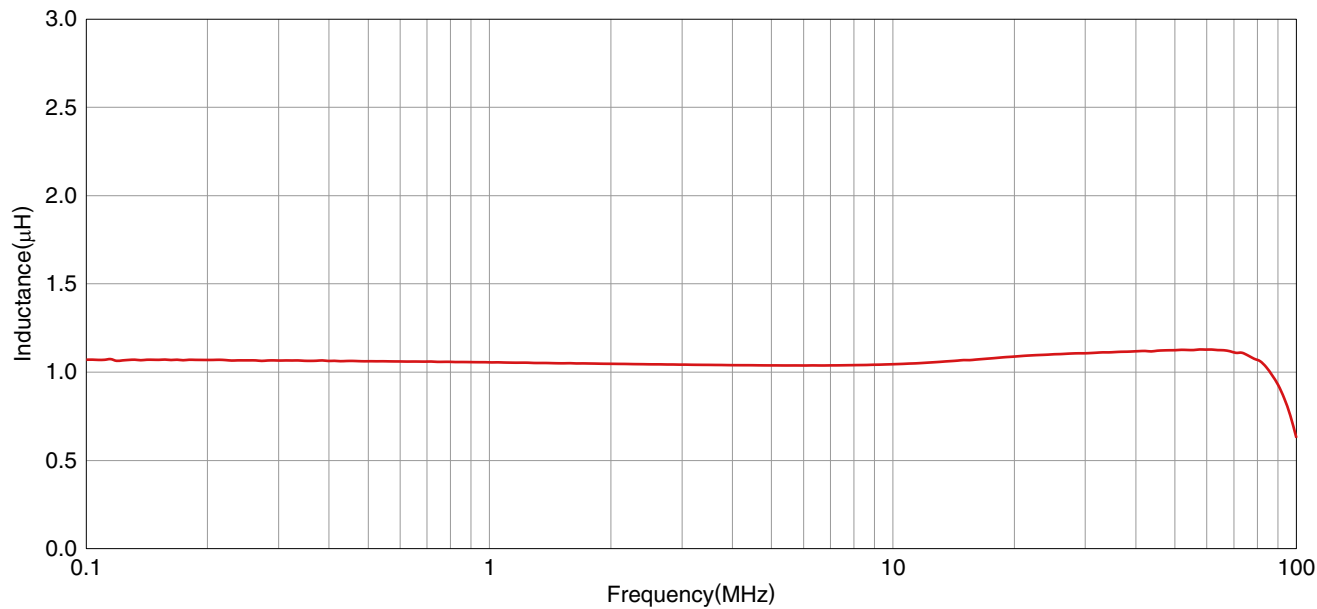

○ Measurement equipment

Product No.	Manufacturer
4294A+16034G	Agilent Technologies

* Equivalent measurement equipment may be used.

MLP_{series} **MLP2012 Type** (V characteristic product, T dimension of the product 0.55mm max.)

■ ELECTRICAL CHARACTERISTICS

□ INDUCTANCE VS. DC BIAS CHARACTERISTICS GRAPH

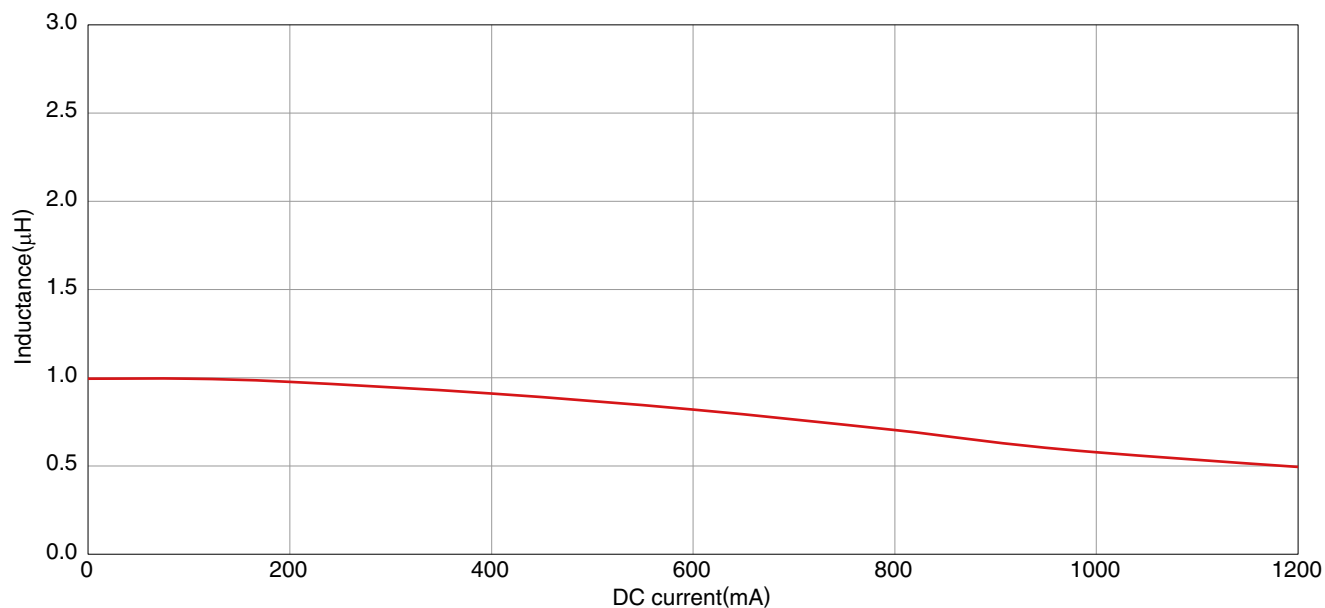

○ Measurement equipment

Product No.	Manufacturer
4285A+42841A+42842C+42851-61100	Agilent Technologies

* Equivalent measurement equipment may be used.

MLP_{series} **MLP2012 Type** (V characteristic product, T dimension of the product 1.0mm max.)

■ ELECTRICAL CHARACTERISTICS

□ L FREQUENCY CHARACTERISTICS GRAPH

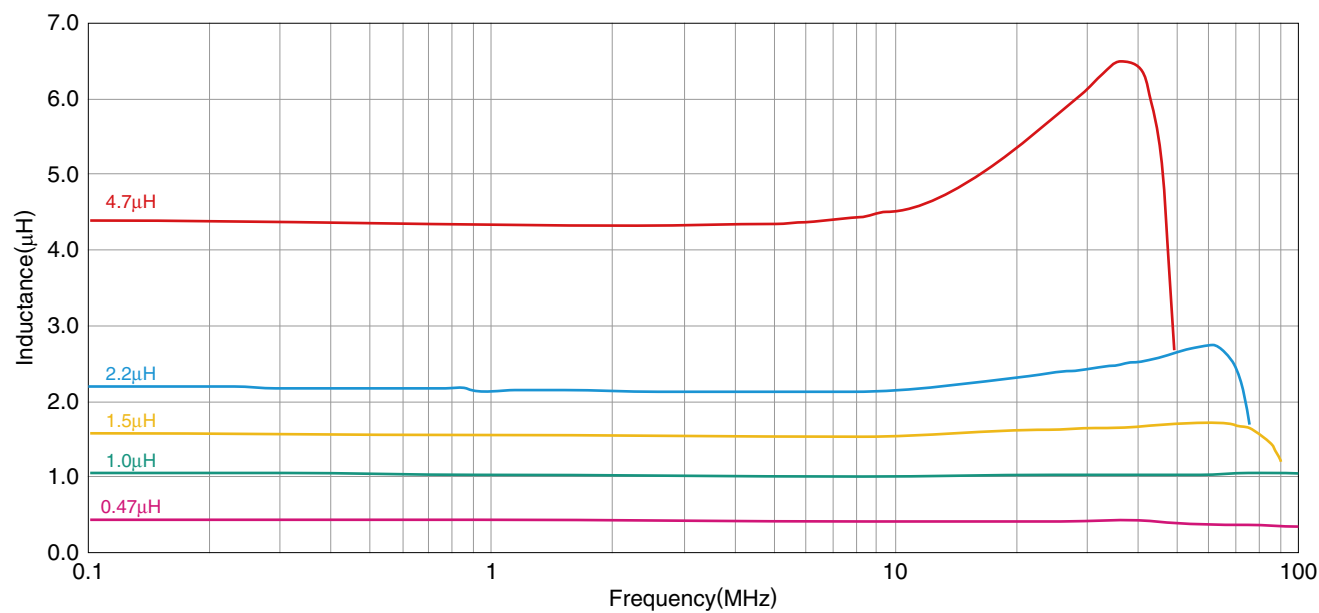

○ Measurement equipment

Product No.	Manufacturer
4294A+16034G	Agilent Technologies

* Equivalent measurement equipment may be used.

MLP_{series} **MLP2012 Type** (V characteristic product, T dimension of the product 1.0mm max.)

■ ELECTRICAL CHARACTERISTICS

□ INDUCTANCE VS. DC BIAS CHARACTERISTICS GRAPH

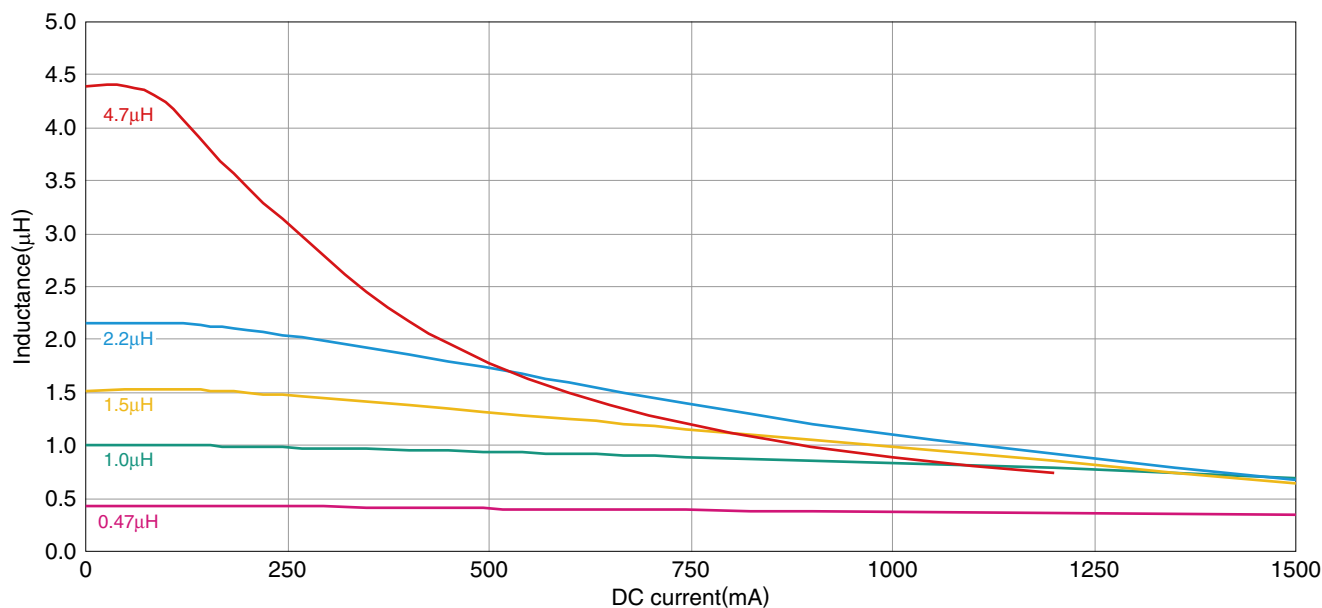

○ Measurement equipment

Product No.	Manufacturer
4285A+42841A+42842C+42851-61100	Agilent Technologies

* Equivalent measurement equipment may be used.

MLP_{series} **MLP2012 Type** (S characteristic product, T dimension of the product 0.55mm max.)

■ ELECTRICAL CHARACTERISTICS

□ L FREQUENCY CHARACTERISTICS GRAPH

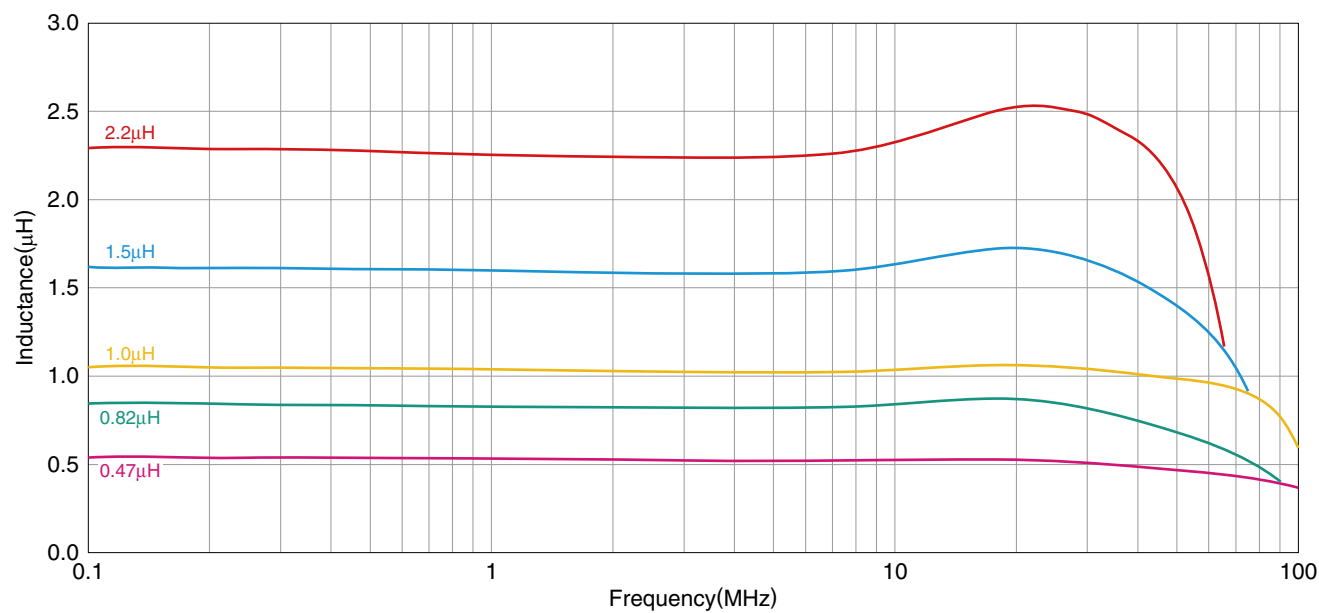

○ Measurement equipment

Product No.	Manufacturer
4294A+16034G	Agilent Technologies

* Equivalent measurement equipment may be used.

MLP_{series} **MLP2012 Type** (S characteristic product, T dimension of the product 0.55mm max.)

■ ELECTRICAL CHARACTERISTICS

□ INDUCTANCE VS. DC BIAS CHARACTERISTICS GRAPH

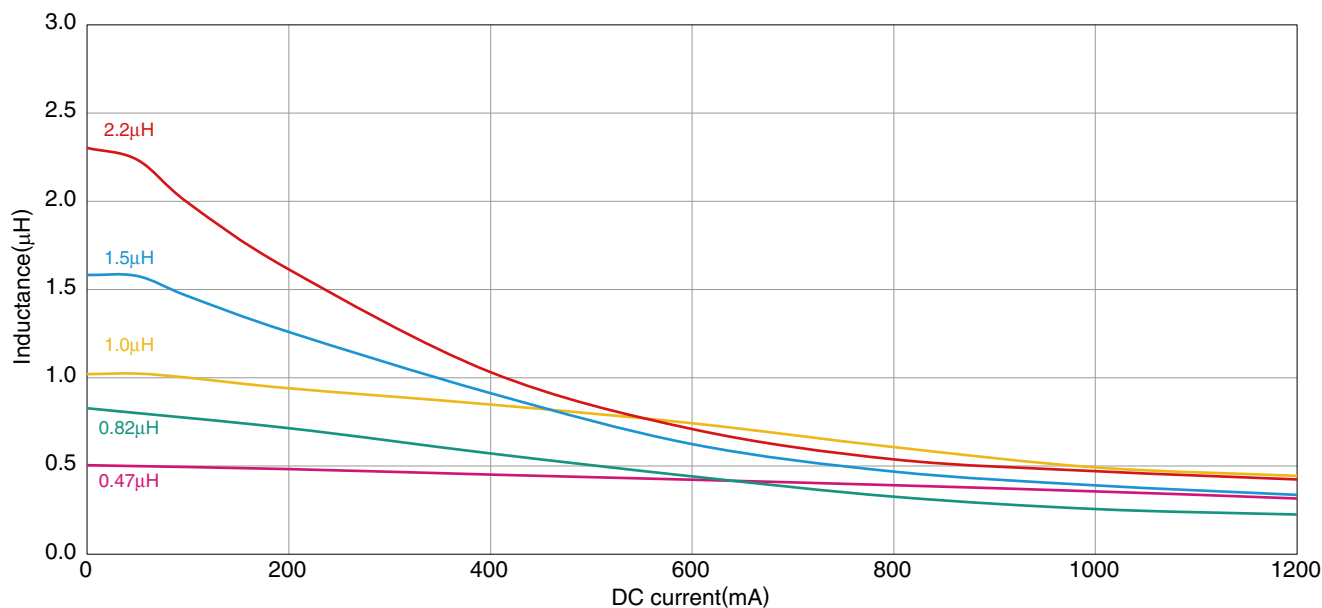

○ Measurement equipment

Product No.	Manufacturer
4285A+42841A+42842C+42851-61100	Agilent Technologies

* Equivalent measurement equipment may be used.

MLP_{series} **MLP2012 Type** (S characteristic product, T dimension of the product 1.0mm max.)

■ ELECTRICAL CHARACTERISTICS

□ L FREQUENCY CHARACTERISTICS GRAPH

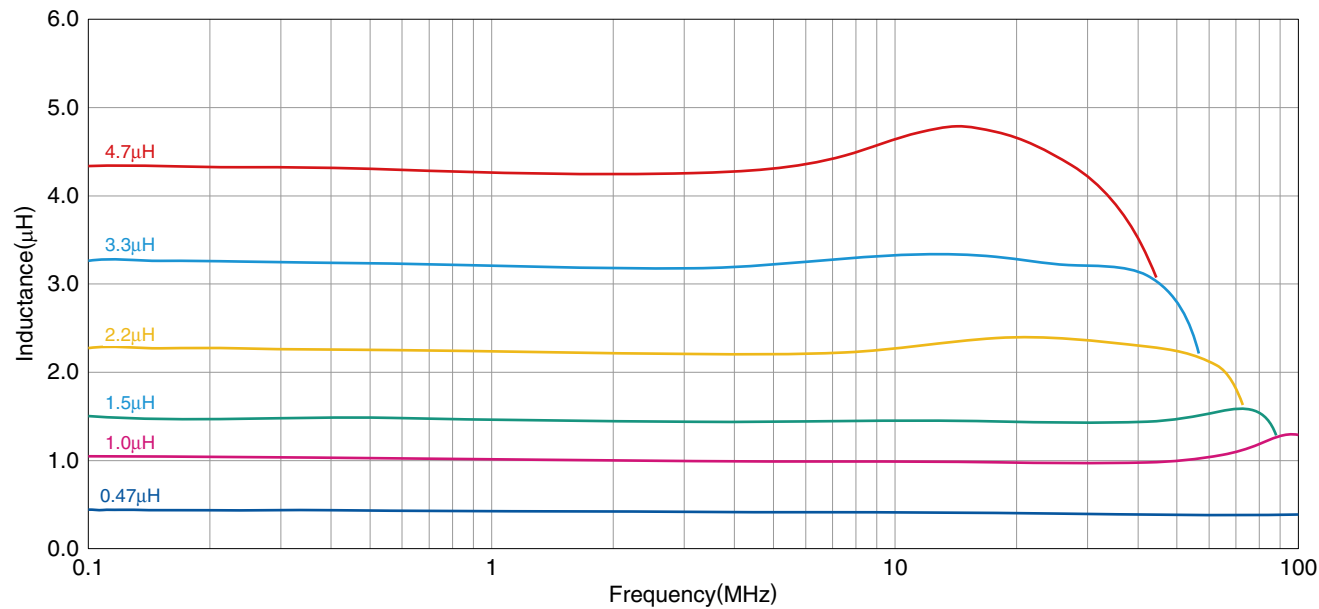

○ Measurement equipment

Product No.	Manufacturer
4294A+16034G	Agilent Technologies

* Equivalent measurement equipment may be used.

MLP_{series} **MLP2012 Type** (S characteristic product, T dimension of the product 1.0mm max.)

■ ELECTRICAL CHARACTERISTICS

□ INDUCTANCE VS. DC BIAS CHARACTERISTICS GRAPH

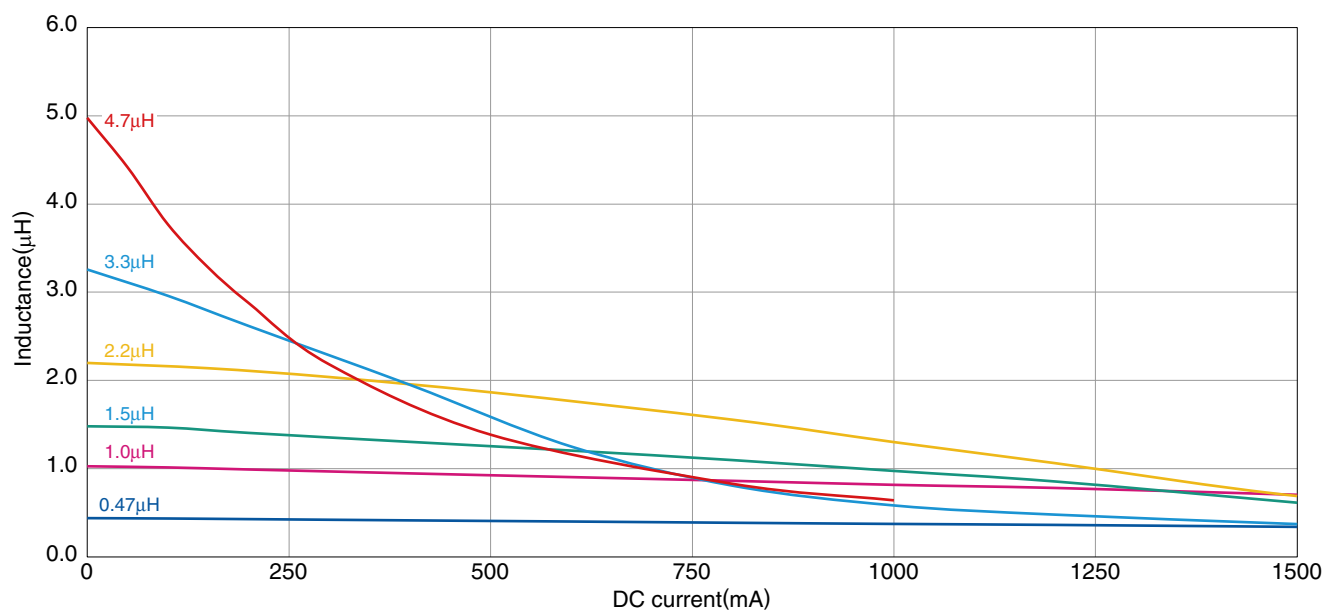

○ Measurement equipment

Product No.	Manufacturer
4285A+42841A+42842C+42851-61100	Agilent Technologies

* Equivalent measurement equipment may be used.

MLP_{series}

MLP2016 Type

■ SHAPE & DIMENSIONS

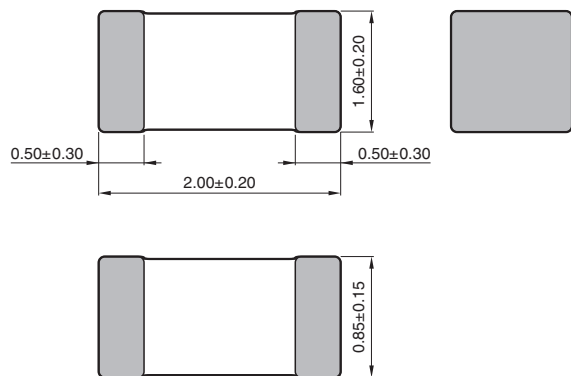

Dimensions in mm

■ RECOMMENDED LAND PATTERN

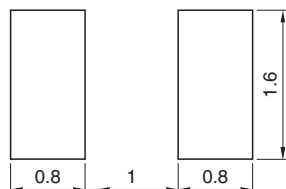

Dimensions in mm

• All specifications are subject to change without notice.

MLP_{series} **MLP2016 Type**

■ ELECTRICAL CHARACTERISTICS

□ CHARACTERISTICS SPECIFICATION TABLE

Type	Thickness T (mm)	L		Measuring frequency (MHz)	DC resistance (Ω)	Rated current* (mA) max.	Part No.**	
	max.	(μH)	tolerance					
Low core loss	1.0	0.47	±20%	2	0.055±25%	1700	MLP2016HR47MT□□□	
	1.0	1.0	±20%	2	0.09±25%	1300	MLP2016H1R0MT□□□	
	Low resistance	1.0	1.5	±20%	2	0.11±25%	1200	MLP2016H1R5MT□□□
		1.0	2.2	±20%	2	0.11±25%	1200	MLP2016H2R2MT□□□
	1.0	3.3	±20%	2	0.12±25%	1200	MLP2016H3R3MT□□□	
	1.0	4.7	±20%	2	0.16±25%	1100	MLP2016H4R7MT□□□	
	Emphasized DC bias characteristics	1.0	0.47	±20%	2	0.07±25%	1500	MLP2016VR47MT□□□
		1.0	1.0	±20%	2	0.12±25%	1200	MLP2016V1R0MT□□□
		1.0	1.5	±20%	2	0.14±25%	1150	MLP2016V1R5MT□□□
		1.0	2.2	±20%	2	0.17±25%	1000	MLP2016V2R2MT□□□
STD product	1.0	0.47	±20%	2	0.05±30%	1600	MLP2016SR47MT□□□	
	1.0	1.0	±20%	2	0.09±30%	1400	MLP2016S1R0MT□□□	
	1.0	1.5	±20%	2	0.09±30%	1200	MLP2016S1R5MT□□□	
	1.0	2.2	±20%	2	0.11±30%	1200	MLP2016S2R2MT□□□	
1.0	4.7	±20%	2	0.27±30%	800	MLP2016S4R7MT□□□		

* Rated current: Current assumed when temperature has risen to 40°C max.

** □□□: Please specify internal code.

○ Measurement equipment

Measurement item	Product No.	Manufacturer
L	4294A+16034G	Agilent Technologies
DC resistance	Type-7561	Yokogawa

* Equivalent measurement equipment may be used.

MLP_{series} **MLP2016 Type** (H characteristic product, T dimension of the product 1.0mm max.)

■ ELECTRICAL CHARACTERISTICS

□ L FREQUENCY CHARACTERISTICS GRAPH

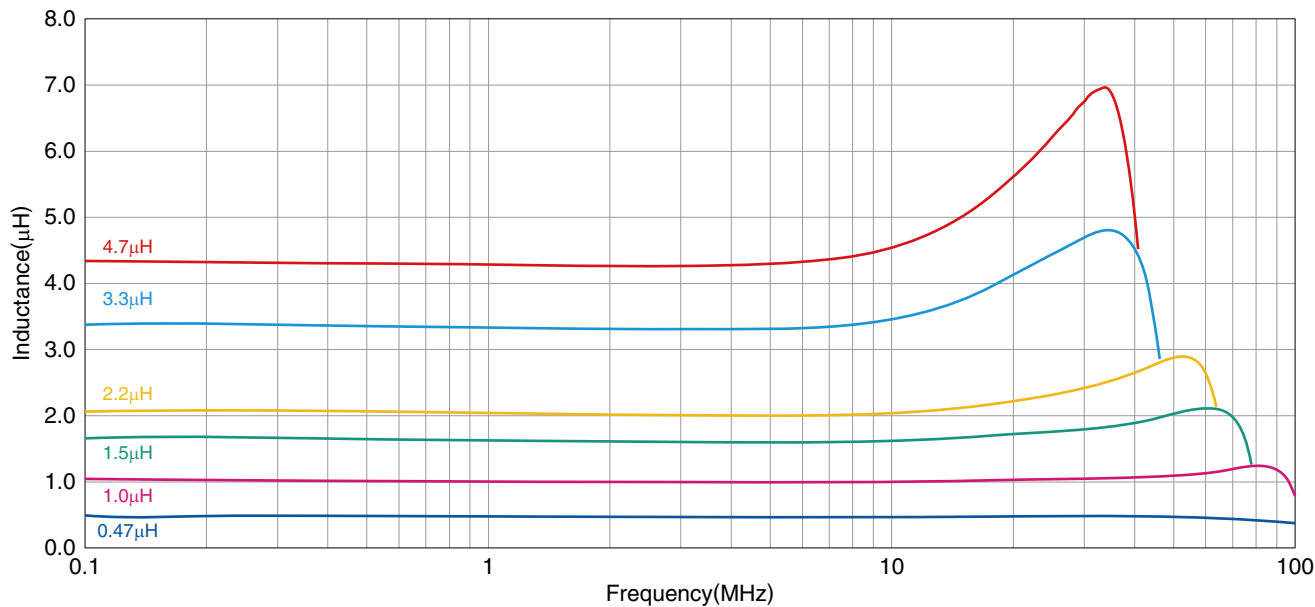

○ Measurement equipment

Product No.	Manufacturer
4294A+16034G	Agilent Technologies

* Equivalent measurement equipment may be used.

MLP_{series} **MLP2016 Type** (H characteristic product, T dimension of the product 1.0mm max.)

■ ELECTRICAL CHARACTERISTICS

□ INDUCTANCE VS. DC BIAS CHARACTERISTICS GRAPH (EXAMPLE)

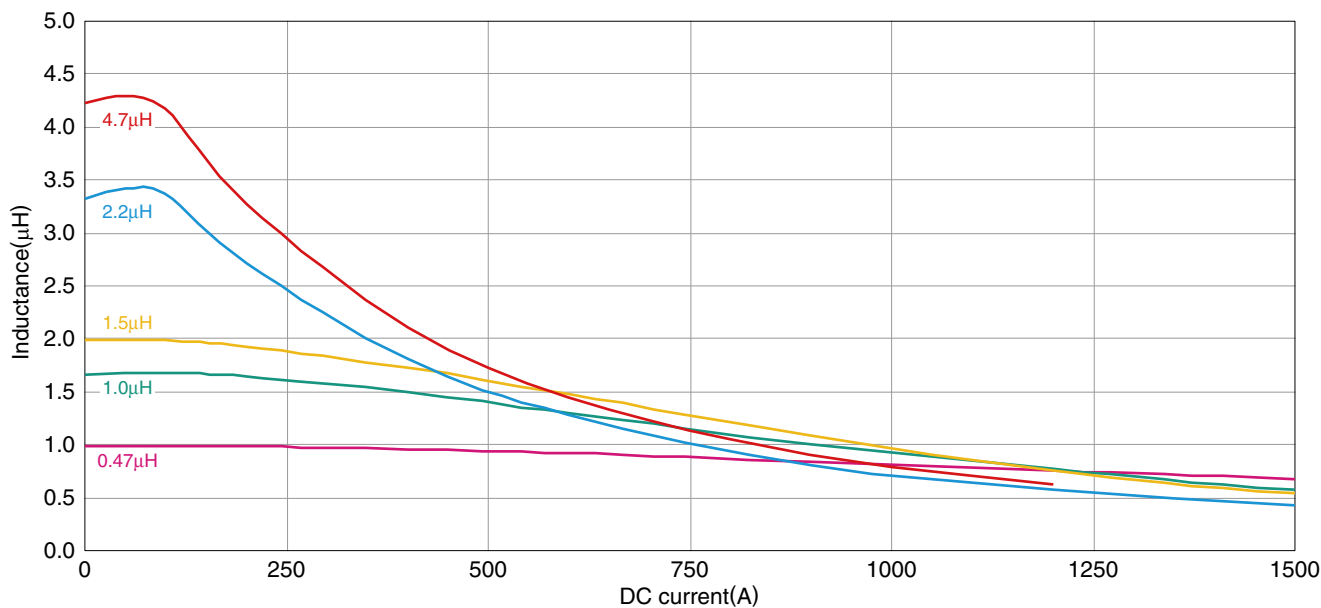

○ Measurement equipment

Product No.	Manufacturer
4285A+42841A+42842C+42851-61100	Agilent Technologies

* Equivalent measurement equipment may be used.

MLP_{series} **MLP2016 Type** (V characteristic product, T dimension of the product 1.0mm max.)

■ ELECTRICAL CHARACTERISTICS

□ L FREQUENCY CHARACTERISTICS GRAPH

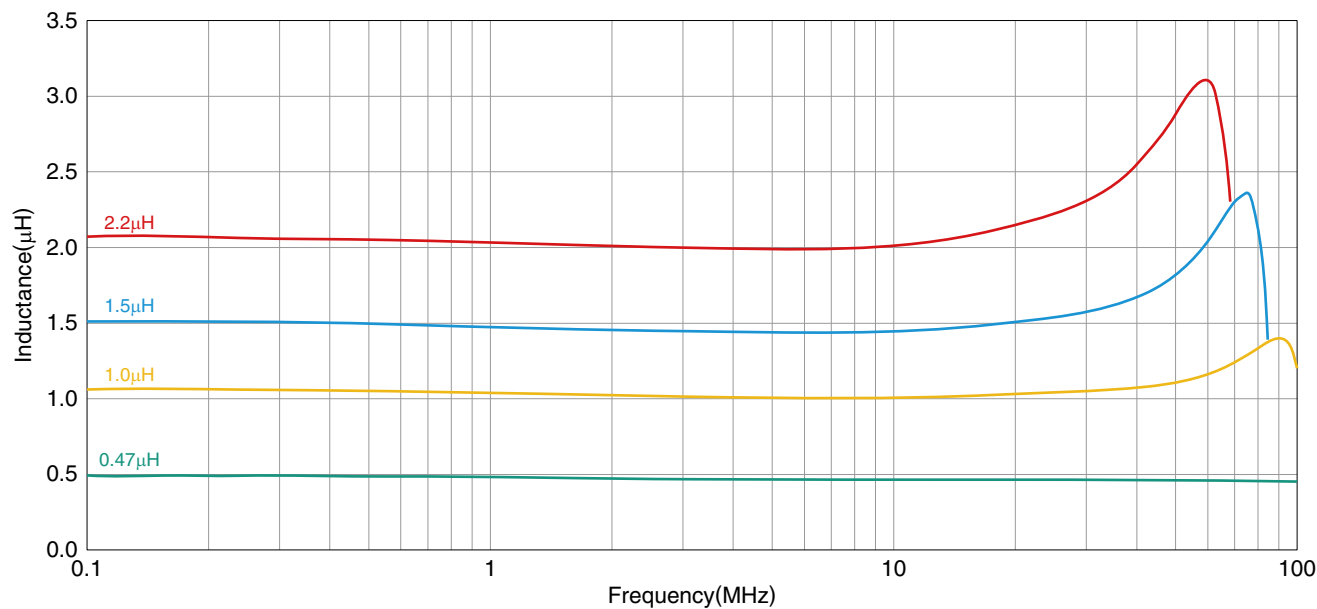

○ Measurement equipment

Product No.	Manufacturer
4294A+16034G	Agilent Technologies

* Equivalent measurement equipment may be used.

MLP_{series} **MLP2016 Type** (V characteristic product, T dimension of the product 1.0mm max.)

■ ELECTRICAL CHARACTERISTICS

□ INDUCTANCE VS. DC BIAS CHARACTERISTICS GRAPH

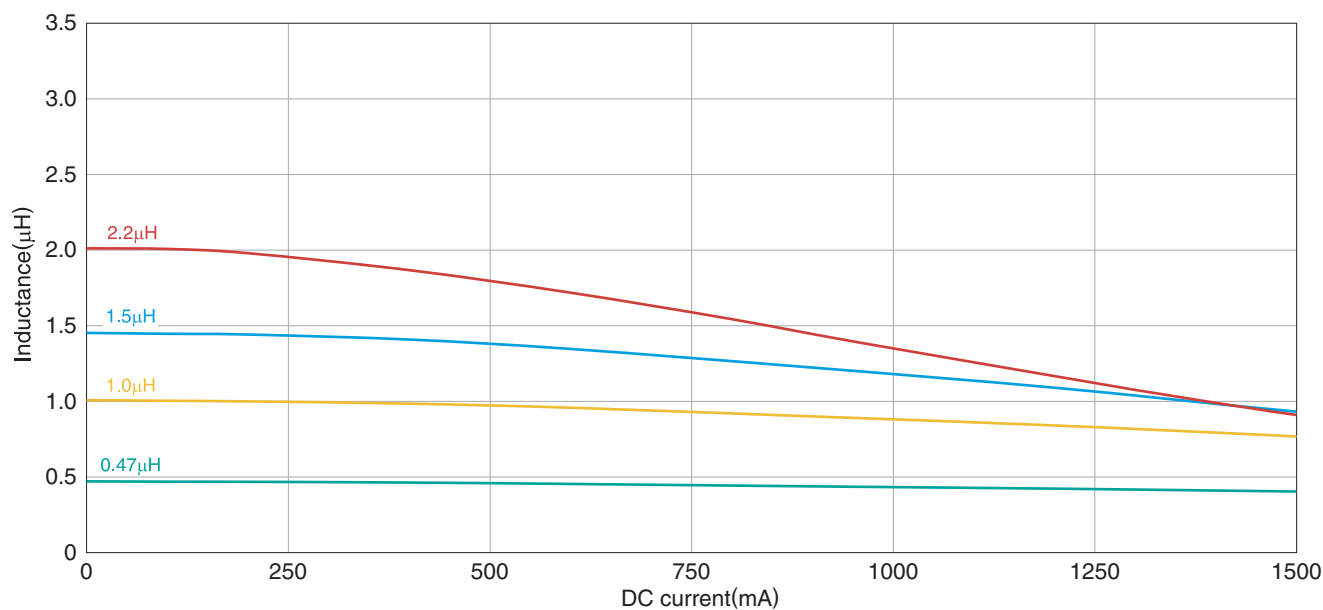

○ Measurement equipment

Product No.	Manufacturer
4285A+42841A+42842C+42851-61100	Agilent Technologies

* Equivalent measurement equipment may be used.

MLP_{series} **MLP2016 Type** (S characteristic product, T dimension of the product 1.0mm max.)

■ ELECTRICAL CHARACTERISTICS

□ L FREQUENCY CHARACTERISTICS GRAPH

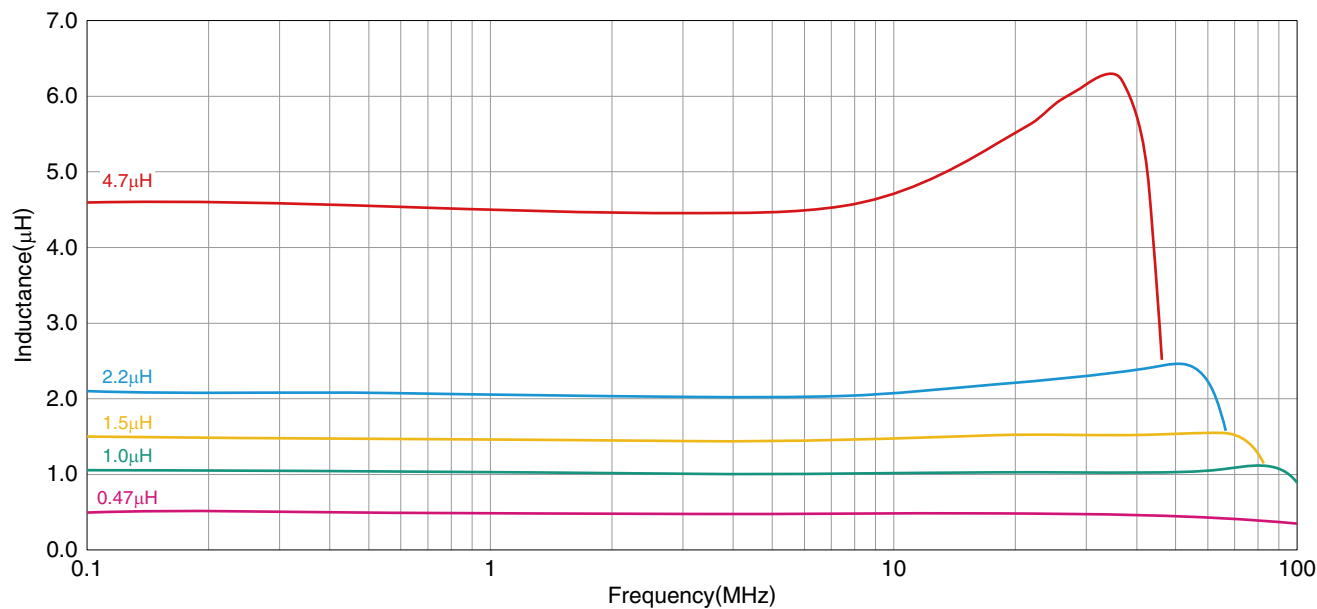

○ Measurement equipment

Product No.	Manufacturer
4294A+16034G	Agilent Technologies

* Equivalent measurement equipment may be used.

MLP_{series} **MLP2016 Type** (S characteristic product, T dimension of the product 1.0mm max.)

■ ELECTRICAL CHARACTERISTICS

□ INDUCTANCE VS. DC BIAS CHARACTERISTICS GRAPH

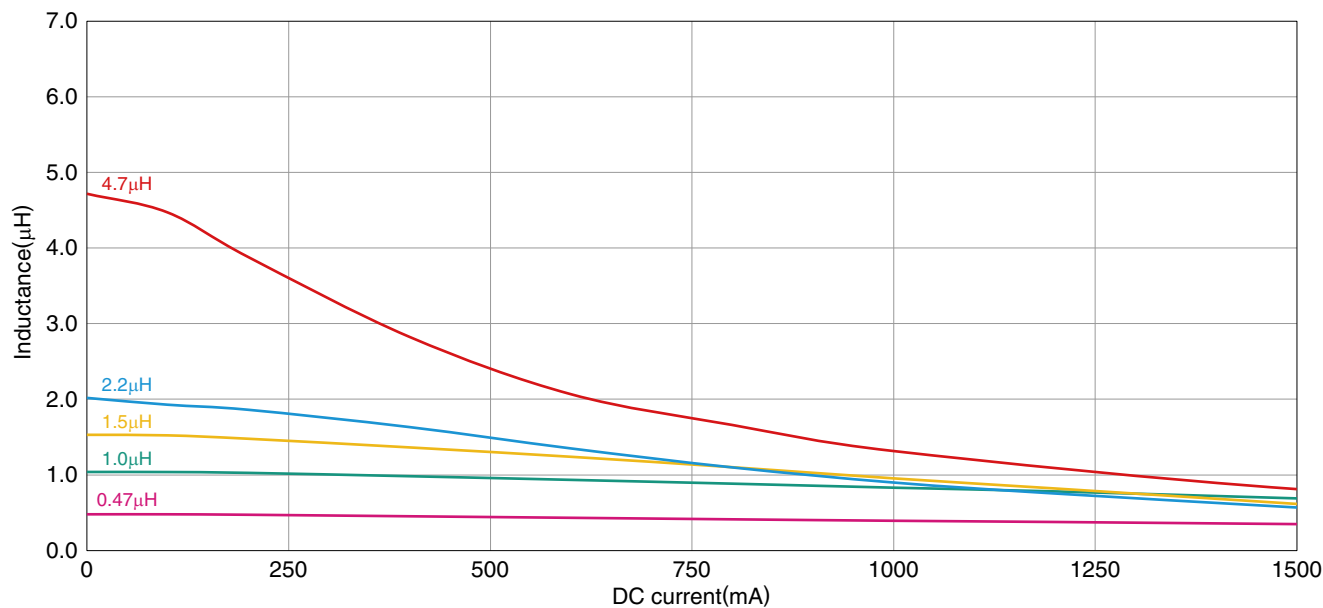

○ Measurement equipment

Product No.	Manufacturer
4285A+42841A+42842C+42851-61100	Agilent Technologies

* Equivalent measurement equipment may be used.

MLP_{series}

MLP2520 Type

■ SHAPE & DIMENSIONS

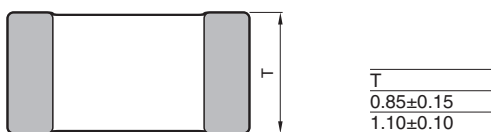
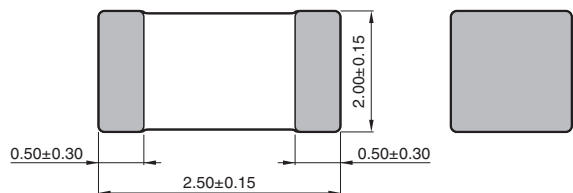

Dimensions in mm

■ RECOMMENDED LAND PATTERN

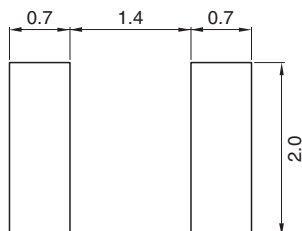

Dimensions in mm

• All specifications are subject to change without notice.

MLP_{series} **MLP2520 Type**

■ ELECTRICAL CHARACTERISTICS

□ CHARACTERISTICS SPECIFICATION TABLE

Type		Thickness T	L		Measuring frequency (MHz)	DC resistance (Ω)±30%	Rated current* (mA) max.	Part No.**		
		(mm) max.	(μH)	tolerance						
Large current	Low resistance	1.0	1.0	±20%	2	0.048	2300	MLP2520K1R0MT□□□		
		1.2	1.0	±20%	2	0.048	2300	MLP2520K1R0ST□□□		
Emphasized low resistance		1.0	0.47	±20%	2	0.044	2100	MLP2520HR47MT□□□		
		1.0	1.0	±20%	2	0.075	1500	MLP2520H1R0MT□□□		
		1.0	2.2	±20%	2	0.09	1300	MLP2520H2R2MT□□□		
		1.0	3.3	±20%	2	0.13	1000	MLP2520H3R3MT□□□		
		1.0	4.7	±20%	2	0.13	1000	MLP2520H4R7MT□□□		
		1.2	1.0	±20%	2	0.07	1600	MLP2520H1R0ST□□□		
		1.2	2.2	±20%	2	0.08	1500	MLP2520H2R2ST□□□		
		1.2	4.7	±20%	2	0.13	1000	MLP2520H4R7ST□□□		
		Low core loss		1.0	0.47	±20%	2	0.06	1700	MLP2520VR47MT□□□
				1.0	1.0	±20%	2	0.10	1300	MLP2520V1R0MT□□□
1.0	1.5			±20%	2	0.10	1400	MLP2520V1R5MT□□□		
1.0	2.2			±20%	2	0.12	1100	MLP2520V2R2MT□□□		
1.0	3.3			±20%	2	0.20	900	MLP2520V3R3MT□□□		
1.0	4.7			±20%	2	0.24	800	MLP2520V4R7MT□□□		
1.2	1.0			±20%	2	0.10	1300	MLP2520V1R0ST□□□		
1.2	1.5			±20%	2	0.10	1400	MLP2520V1R5ST□□□		
1.2	2.2			±20%	2	0.12	1100	MLP2520V2R2ST□□□		
1.2	4.7			±20%	2	0.22	800	MLP2520V4R7ST□□□		
STD product		1.0	1.0	±20%	2	0.085	1500	MLP2520S1R0MT□□□		
		1.0	1.5	±20%	2	0.09	1200	MLP2520S1R5MT□□□		
		1.0	2.2	±20%	2	0.09	1200	MLP2520S2R2MT□□□		
		1.0	3.3	±20%	2	0.13	1000	MLP2520S3R3MT□□□		
		1.0	4.7	±20%	2	0.13	1000	MLP2520S4R7MT□□□		
		1.0	10.0	±20%	2	0.28	700	MLP2520S100MT□□□		
		1.2	1.2	±20%	2	0.08	1500	MLP2520S1R0ST□□□		
		1.2	2.5	±20%	2	0.11	1200	MLP2520S2R2ST□□□		
		1.2	3.3	±20%	2	0.11	1000	MLP2520S3R3ST□□□		
		1.2	4.7	±20%	2	0.11	1000	MLP2520S4R7ST□□□		
		1.2	10.0	±20%	2	0.28	700	MLP2520S100ST□□□		

* Rated current: Current assumed when temperature has risen to 40°C max.

** □□□: Please specify internal code.

○ Measurement equipment

Measurement item	Product No.	Manufacturer
L	4294A+16034G	Agilent Technologies
DC resistance	Type-7561	Yokogawa

* Equivalent measurement equipment may be used.

MLP_{series} **MLP2520 Type** (K characteristic product)

■ ELECTRICAL CHARACTERISTICS

□ L FREQUENCY CHARACTERISTICS GRAPH

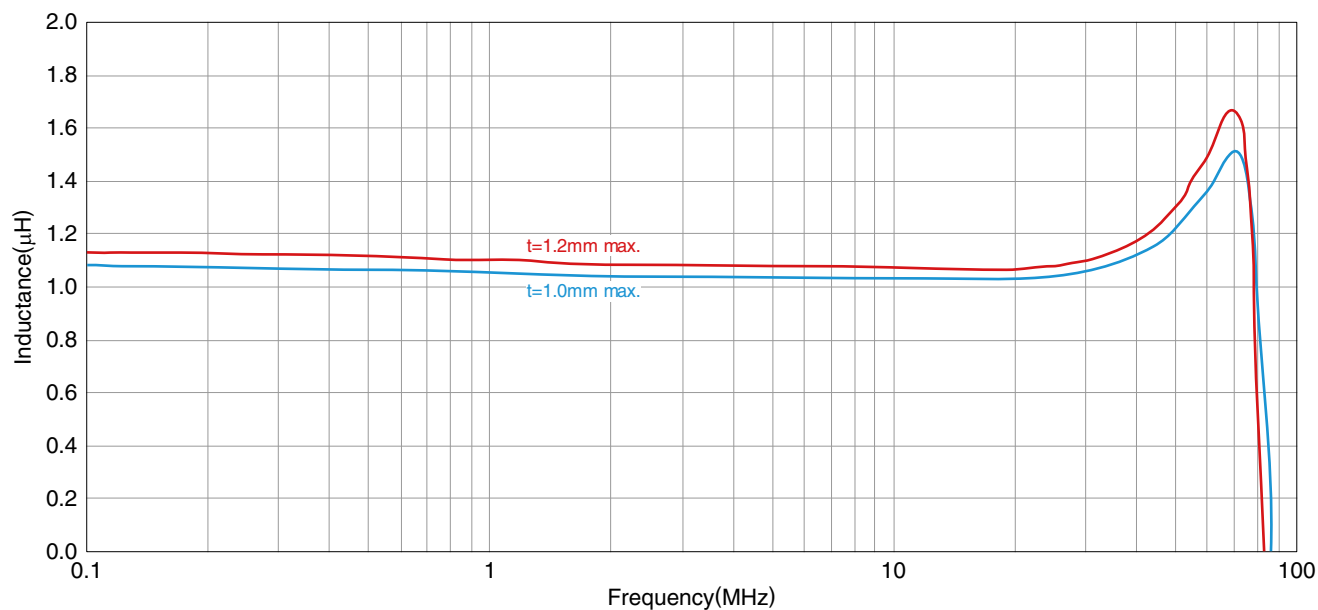

○ Measurement equipment

Product No.	Manufacturer
4294A+16034G	Agilent Technologies

* Equivalent measurement equipment may be used.

MLP_{series} **MLP2520 Type** (K characteristic product)

■ ELECTRICAL CHARACTERISTICS

□ INDUCTANCE VS. DC BIAS CHARACTERISTICS GRAPH

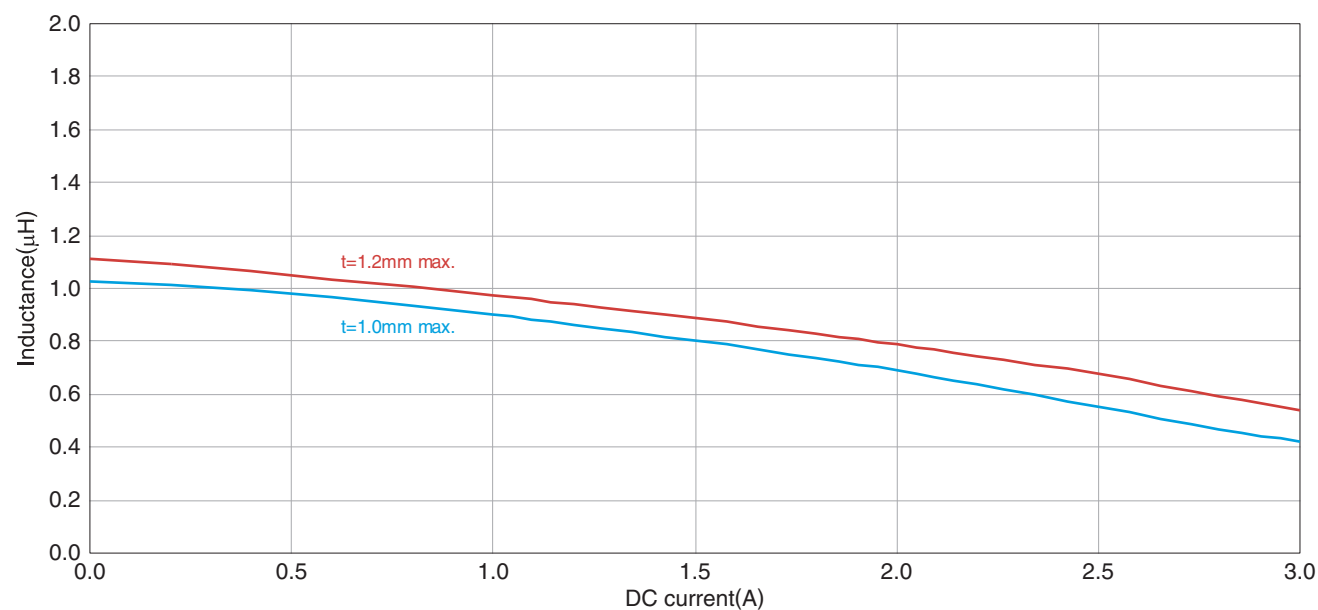

○ Measurement equipment

Product No.	Manufacturer
4285A+42841A+42842C+42851-61100	Agilent Technologies

* Equivalent measurement equipment may be used.

MLP_{series} **MLP2520 Type** (H characteristic product, T dimension of the product 1.0mm max.)

■ ELECTRICAL CHARACTERISTICS

□ L FREQUENCY CHARACTERISTICS GRAPH

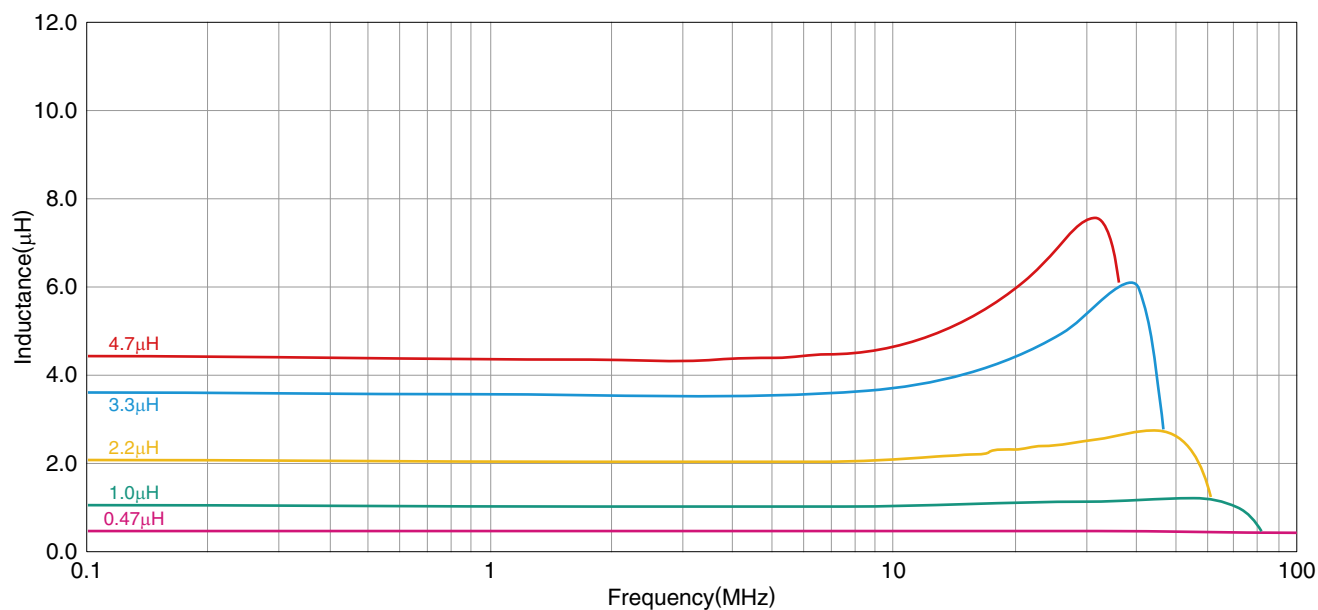

○ Measurement equipment

Product No.	Manufacturer
4294A+16034G	Agilent Technologies

* Equivalent measurement equipment may be used.

MLP_{series} MLP2520 Type (H characteristic product, T dimension of the product 1.0mm max.)

■ ELECTRICAL CHARACTERISTICS

□ INDUCTANCE VS. DC BIAS CHARACTERISTICS GRAPH

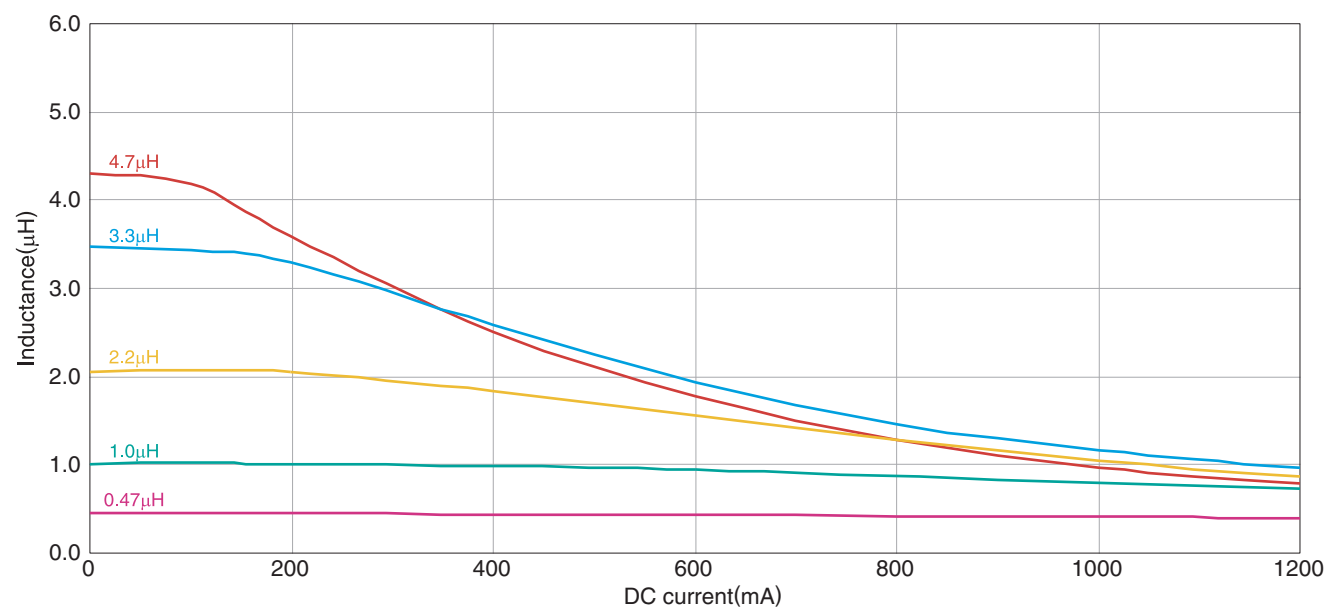

○ Measurement equipment

Product No.	Manufacturer
4285A+42841A+42842C+42851-61100	Agilent Technologies

* Equivalent measurement equipment may be used.

MLP_{series} **MLP2520 Type** (H characteristic product, T dimension of the product 1.2mm max.)

■ ELECTRICAL CHARACTERISTICS

□ L FREQUENCY CHARACTERISTICS GRAPH

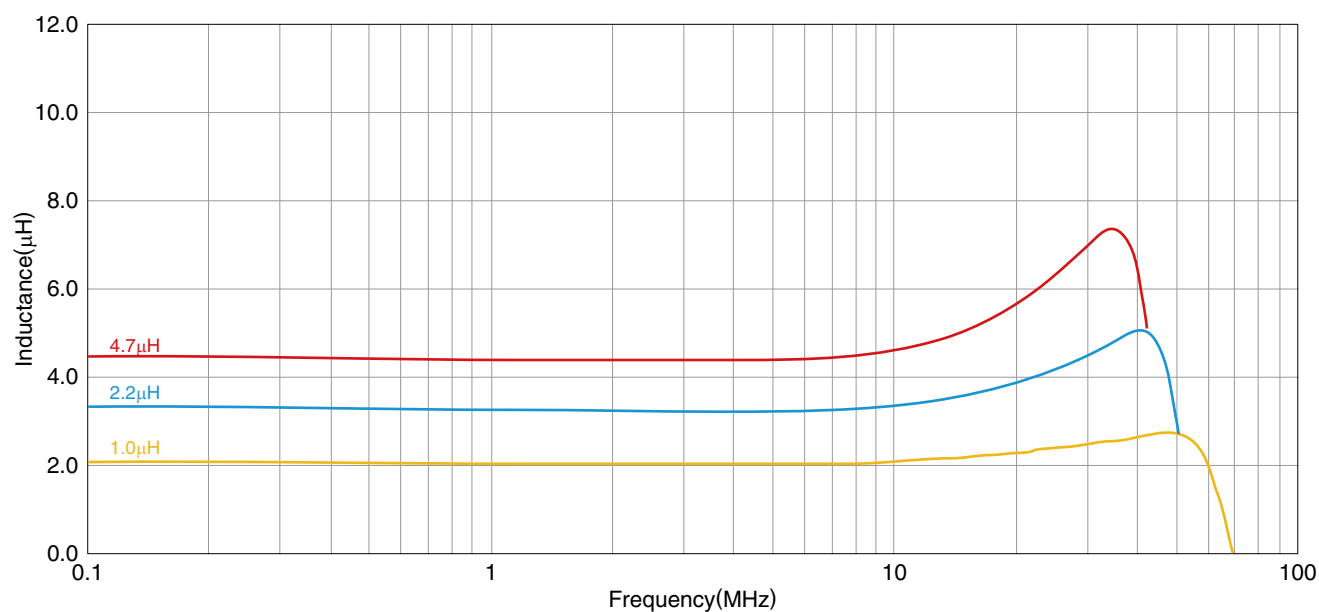

○ Measurement equipment

Product No.	Manufacturer
4294A+16034G	Agilent Technologies

* Equivalent measurement equipment may be used.

MLP_{series} MLP2520 Type (H characteristic product, T dimension of the product 1.2mm max.)

■ ELECTRICAL CHARACTERISTICS

□ INDUCTANCE VS. DC BIAS CHARACTERISTICS GRAPH

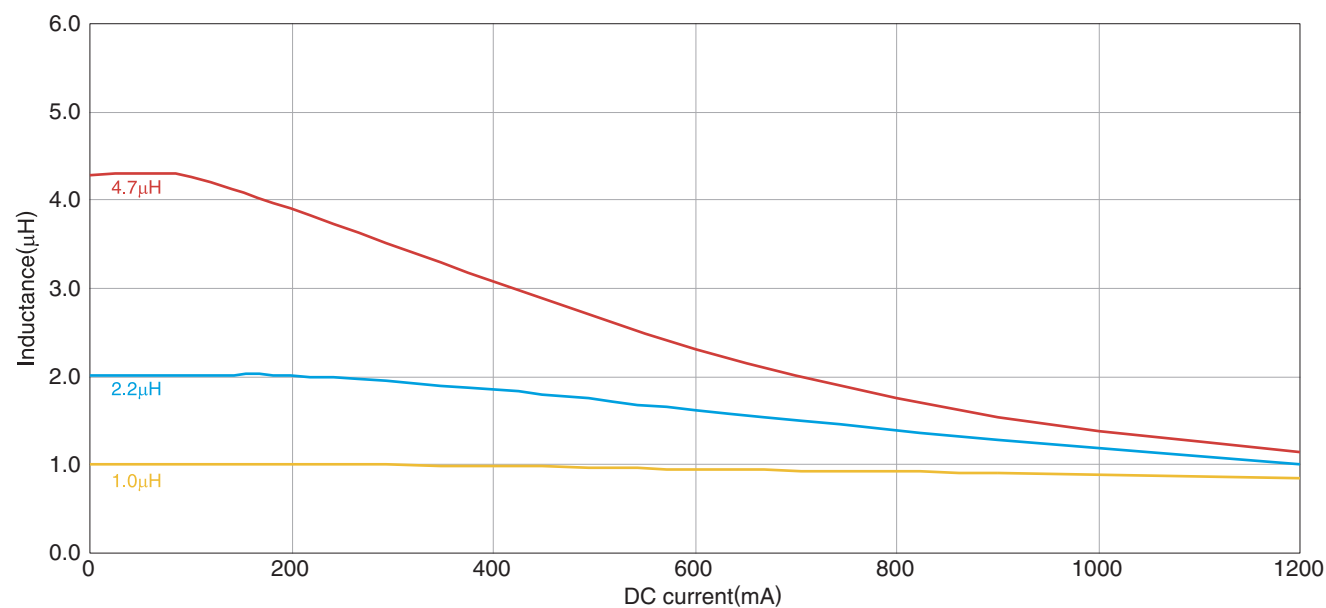

○ Measurement equipment

Product No.	Manufacturer
4285A+42841A+42842C+42851-61100	Agilent Technologies

* Equivalent measurement equipment may be used.

MLP_{series} **MLP2520 Type** (V characteristic product, T dimension of the product 1.0mm max.)

■ ELECTRICAL CHARACTERISTICS

□ L FREQUENCY CHARACTERISTICS GRAPH

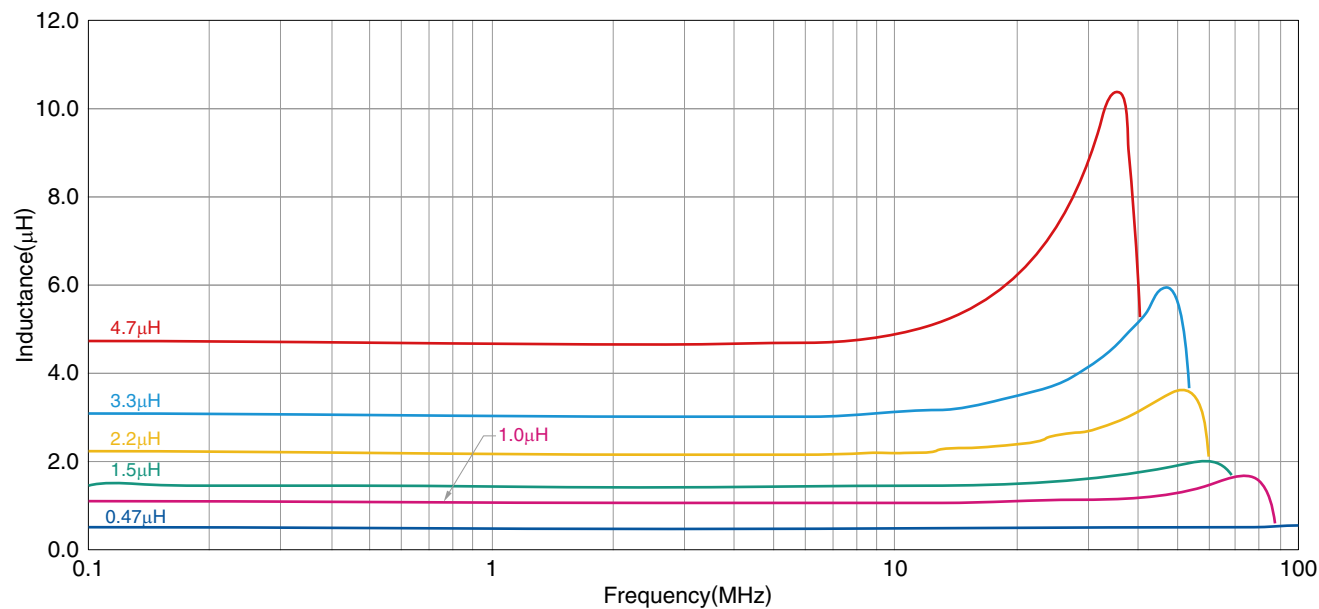

○ Measurement equipment

Product No.	Manufacturer
4294A+16034G	Agilent Technologies

* Equivalent measurement equipment may be used.

MLP_{series} **MLP2520 Type** (V characteristic product, T dimension of the product 1.0mm max.)

■ ELECTRICAL CHARACTERISTICS

□ INDUCTANCE VS. DC BIAS CHARACTERISTICS GRAPH

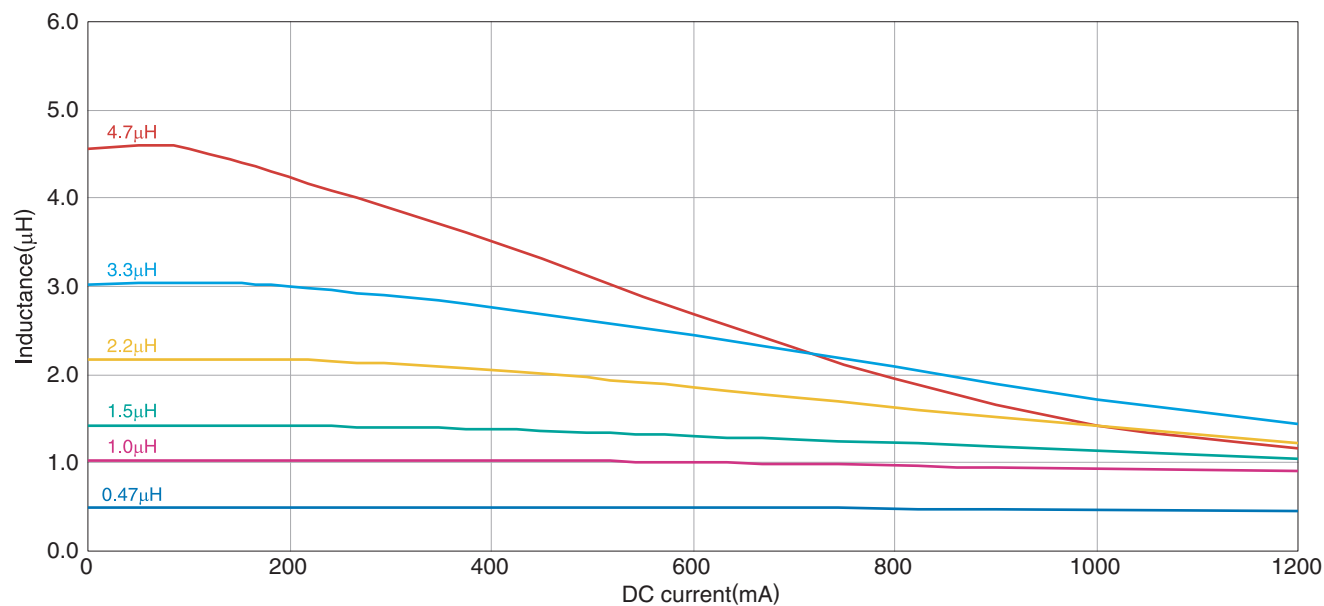

○ Measurement equipment

Product No.	Manufacturer
4285A+42841A+42842C+42851-61100	Agilent Technologies

* Equivalent measurement equipment may be used.

MLP_{series} **MLP2520 Type** (V characteristic product, T dimension of the product 1.2mm max.)

■ ELECTRICAL CHARACTERISTICS

□ L FREQUENCY CHARACTERISTICS GRAPH

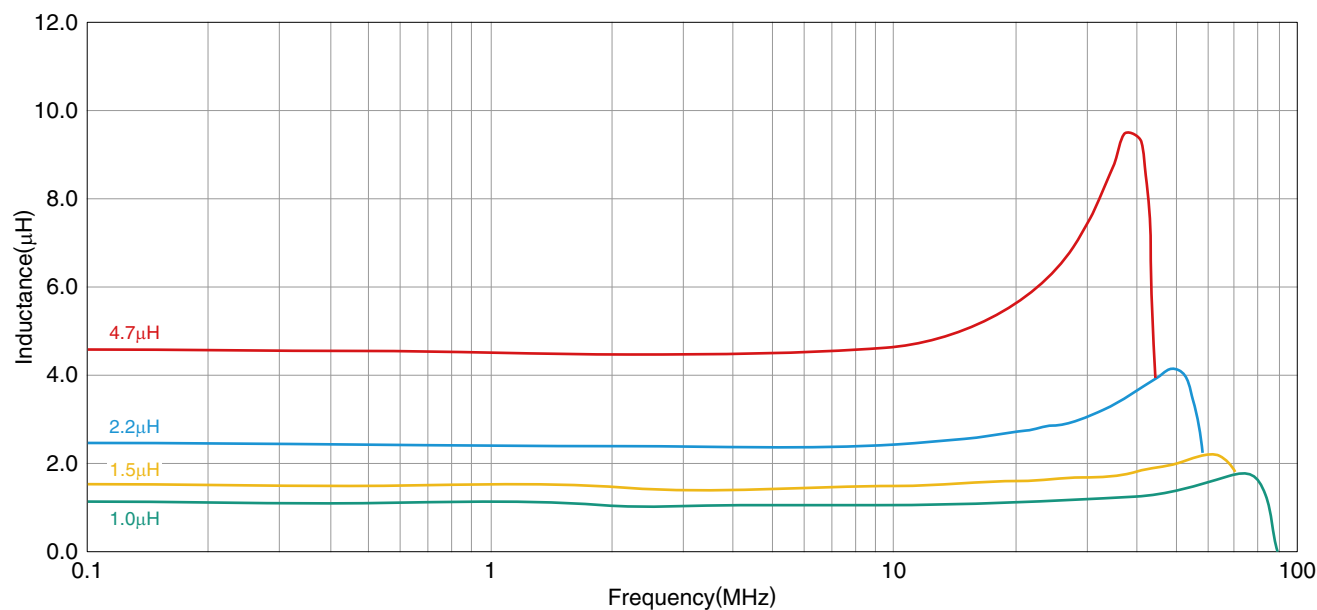

○ Measurement equipment

Product No.	Manufacturer
4294A+16034G	Agilent Technologies

* Equivalent measurement equipment may be used.

MLP_{series} MLP2520 Type (V characteristic product, T dimension of the product 1.2mm max.)

■ ELECTRICAL CHARACTERISTICS

□ INDUCTANCE VS. DC BIAS CHARACTERISTICS GRAPH

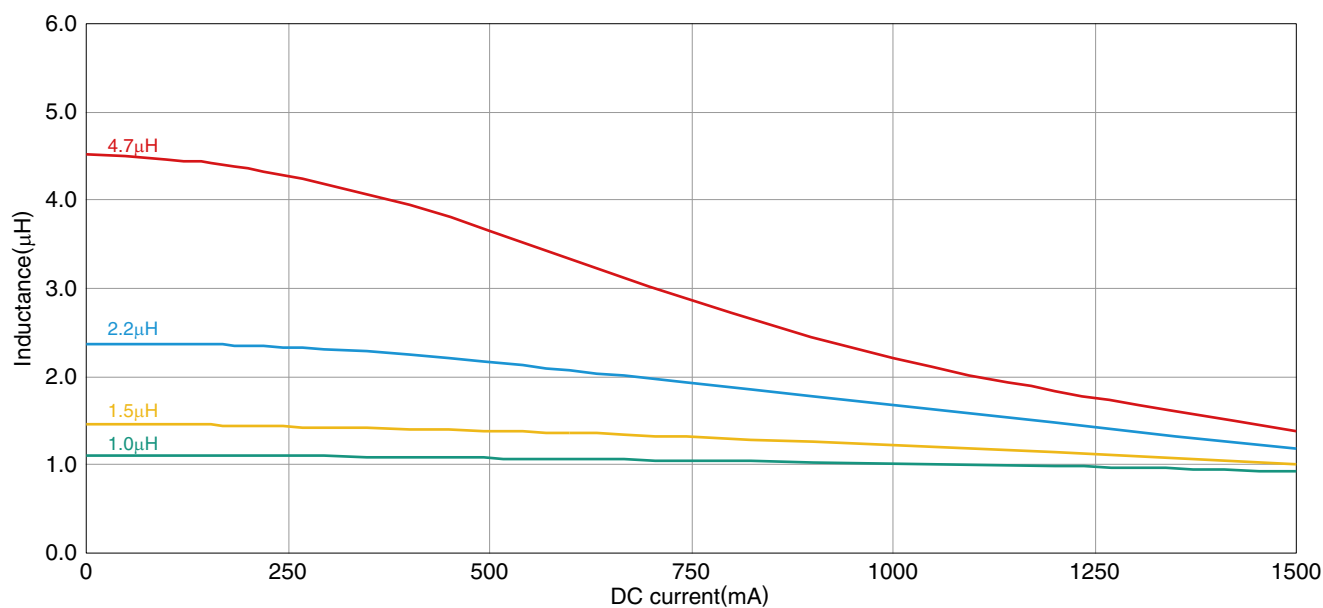

○ Measurement equipment

Product No.	Manufacturer
4285A+42841A+42842C+42851-61100	Agilent Technologies

* Equivalent measurement equipment may be used.

MLP_{series} **MLP2520 Type** (S characteristic product, T dimension of the product 1.0mm max.)

■ ELECTRICAL CHARACTERISTICS

□ L FREQUENCY CHARACTERISTICS GRAPH

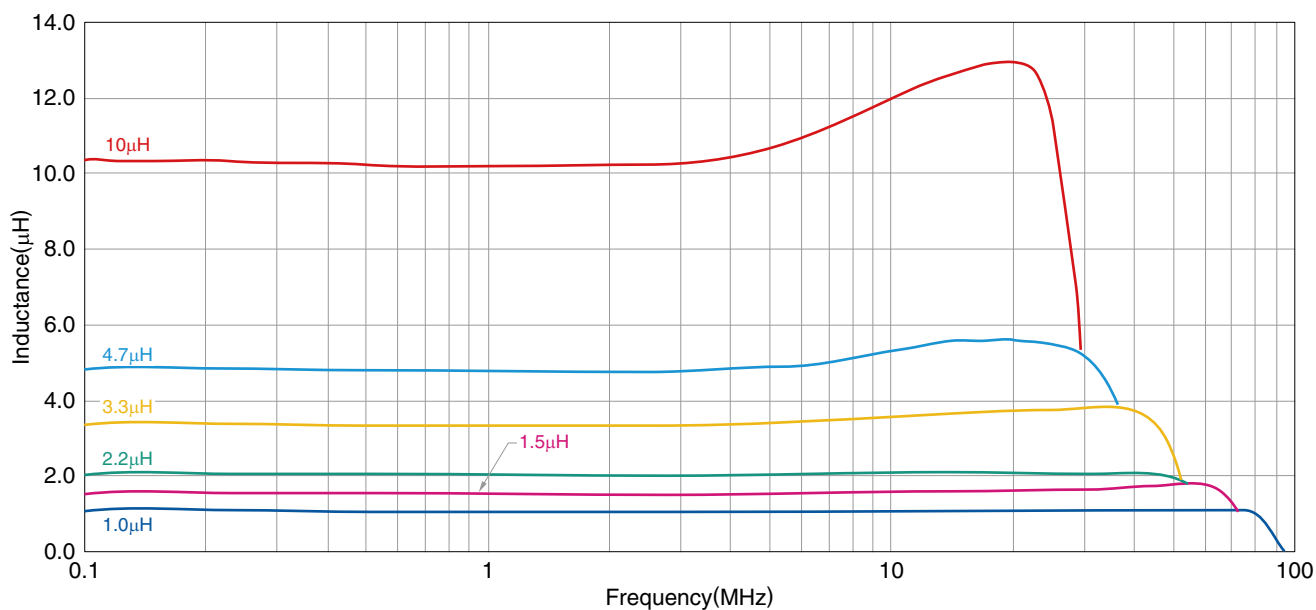

○ Measurement equipment

Product No.	Manufacturer
4294A+16034G	Agilent Technologies

* Equivalent measurement equipment may be used.

MLP_{series} **MLP2520 Type** (S characteristic product, T dimension of the product 1.0mm max.)

■ ELECTRICAL CHARACTERISTICS

□ INDUCTANCE VS. DC BIAS CHARACTERISTICS GRAPH

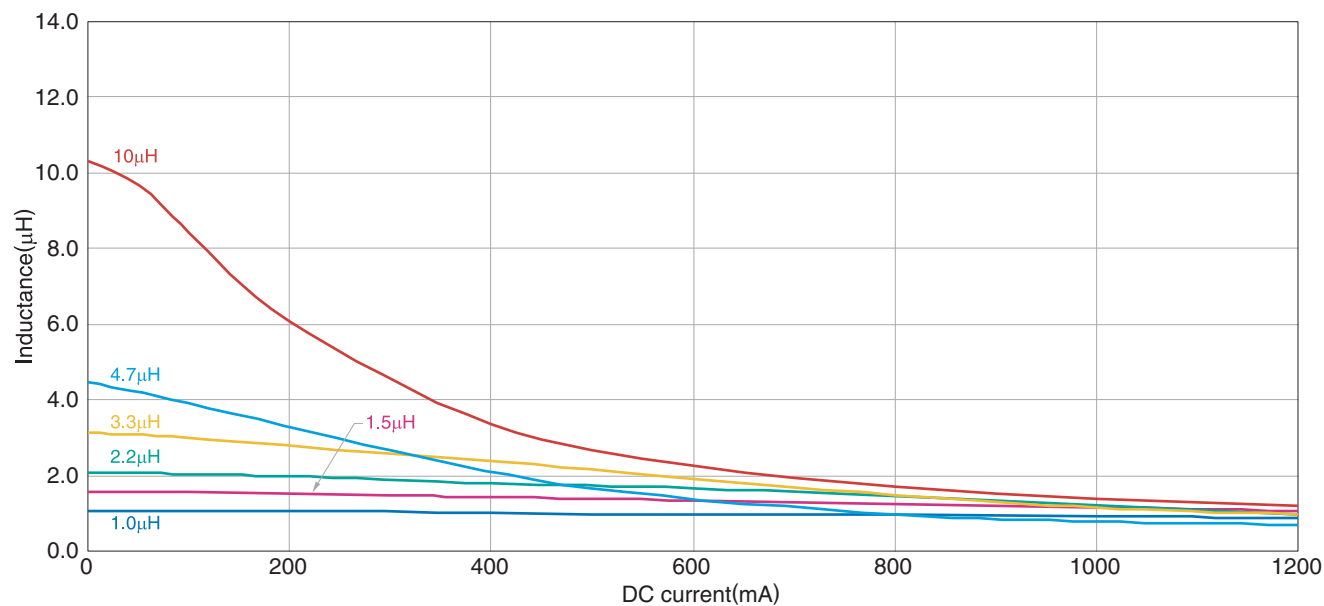

○ Measurement equipment

Product No.	Manufacturer
4285A+42841A+42842C+42851-61100	Agilent Technologies

* Equivalent measurement equipment may be used.

MLP_{series} **MLP2520 Type** (S characteristic product, T dimension of the product 1.2mm max.)

■ ELECTRICAL CHARACTERISTICS

□ L FREQUENCY CHARACTERISTICS GRAPH

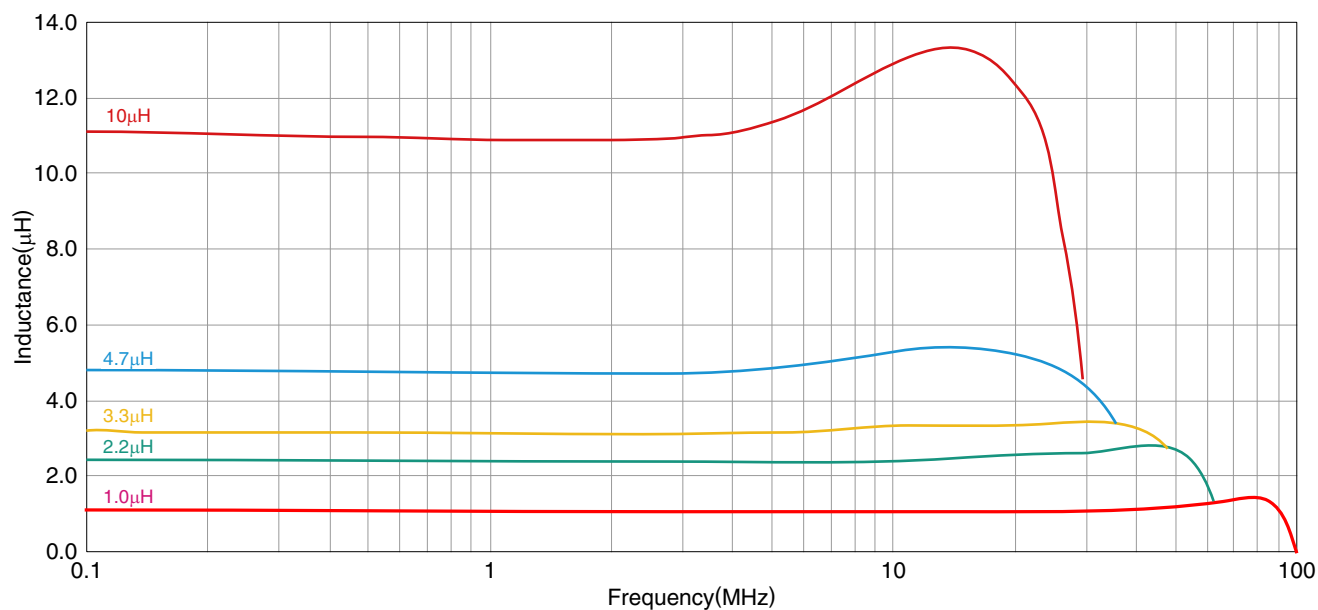

○ Measurement equipment

Product No.	Manufacturer
4294A+16034G	Agilent Technologies

* Equivalent measurement equipment may be used.

MLP_{series} **MLP2520 Type** (S characteristic product, T dimension of the product 1.2mm max.)

■ ELECTRICAL CHARACTERISTICS

□ INDUCTANCE VS. DC BIAS CHARACTERISTICS GRAPH

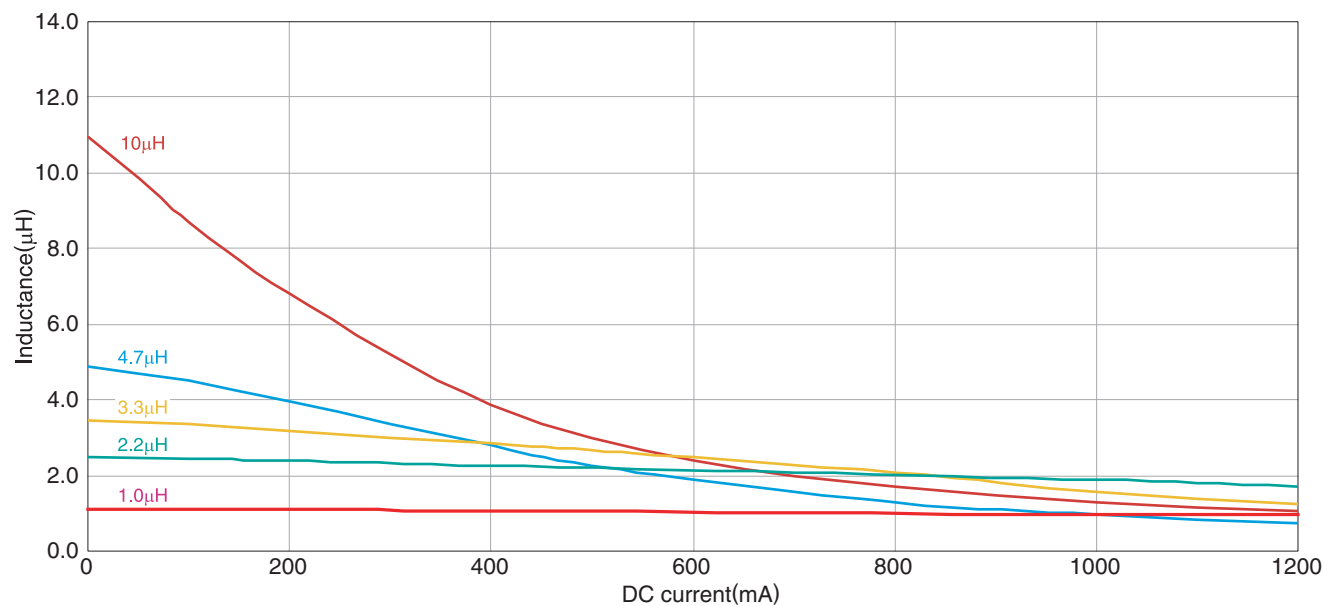

○ Measurement equipment

Product No.	Manufacturer
4285A+42841A+42842C+42851-61100	Agilent Technologies

* Equivalent measurement equipment may be used.

MLP_{series}

Packaging Style

REEL DIMENSIONS

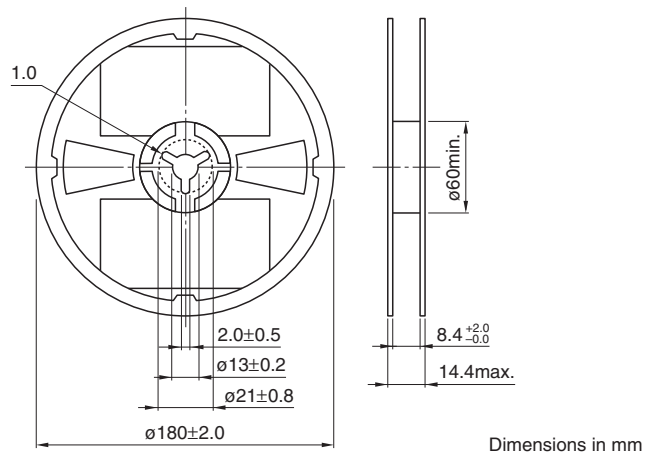

TAPE DIMENSIONS

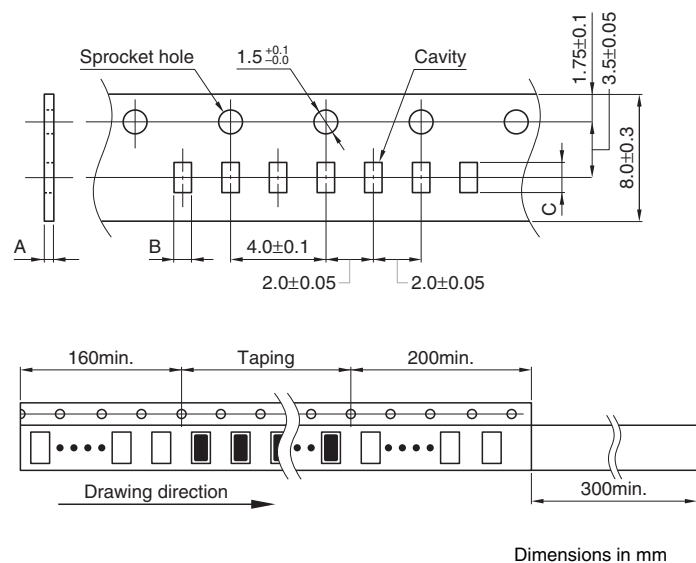

Type	A	B	C
MLP1608	1.1max.	1.1±0.2	1.9±0.2
MLP2012	1.1max.	1.5±0.2	2.3±0.2
MLP2016	1.1max.	1.5±0.2	2.3±0.2
MLP2520	1.5max.	2.3±0.2	2.7±0.1

• All specifications are subject to change without notice.