

SMD Inductors(Coils) For Signal Line(Multilayer, Magnetic Shielded)

Conformity to RoHS Directive

MLF Series MLF2012

FEATURES

- High-reliability monolithic structure.
- Ferrite core and magnetic shielding enables the design of compact circuits with high packing density.
- Excellent solderability and high heat resistance permits either flow or reflow soldering.
- The products contain no lead and also support lead-free soldering.
- It is a product conforming to RoHS directive.

APPLICATIONS

Digital cellular phone, car audio, TV, personal computers, or various electronic appliances.

SPECIFICATIONS

Operating temperature range	-25 to +85°C
Storage temperature range	-40 to +85°C[Unit of products]

RECOMMENDED SOLDERING CONDITION REFLOW SOLDERING

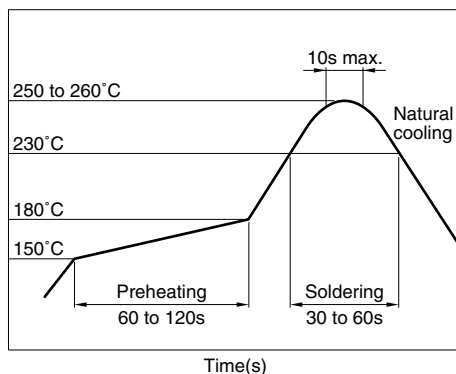

PRODUCT IDENTIFICATION

MLF	2012	A	1R0	K	T
(1)	(2)	(3)	(4)	(5)	(6)

(1) Series name

(2) Dimensions L×W

2012	2.0×1.25mm
------	------------

(3) Material code

(4) Inductance value

47N	47nH[0.047μH]
R15	0.15μH
1R0	1μH
100	10μH

(5) Inductance tolerance

K	±10%
M	±20%

(6) Packaging style

T	Taping [reel]
---	---------------

PACKAGING STYLE AND QUANTITIES

Packaging style	Product's thickness	Quantity
Taping	0.85mm	4000 pieces/reel
	1.25mm	2000 pieces/reel

HANDLING AND PRECAUTIONS

- Before soldering, be sure to preheat components.
The preheating temperature should be set so that the temperature difference between the solder temperature and product temperature does not exceed 150°C.
- After mounting components onto the printed circuit board, do not apply stress through board bending or mishandling.
- The inductance value may change due to magnetic saturation if the current exceeds the rated maximum.
- Do not expose the inductors to stray magnetic fields.
- Avoid static electricity discharge during handling.
- When hand soldering, apply the soldering iron to the printed circuit board only. Temperature of the iron tip should not exceed 350°C. Soldering time should not exceed 3 seconds.

• Conformity to RoHS Directive: This means that, in conformity with EU Directive 2002/95/EC, lead, cadmium, mercury, hexavalent chromium, and specific bromine-based flame retardants, PBB and PBDE, have not been used, except for exempted applications.

• Please contact our Sales office when your application are considered the following:
The device's failure or malfunction may directly endanger human life (e.g. application for automobile/aircraft/medical/nuclear power devices, etc.)

• All specifications are subject to change without notice.

SHAPES AND DIMENSIONS/RECOMMENDED PC BOARD PATTERN

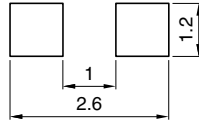
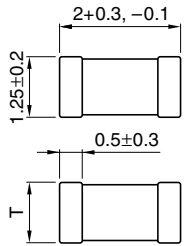

T	Weight(mg)
0.85±0.2	10
1.25±0.2	14

Dimensions in mm



ELECTRICAL CHARACTERISTICS

Inductance (μ H)	Inductance tolerance	Q		Test frequency L, Q (MHz)	Test current L, Q (mA)	Self-resonant frequency (MHz)		DC resistance (Ω)		Rated current (mA)max.	Thickness T (mm)	Part No.
		min.	typ.			min.	typ.	max.	typ.			
0.047	$\pm 20\%$	15	25	50	1.0	550	700	0.10	0.05	300	0.85	MLF2012D47N*1MT
0.068	$\pm 20\%$	15	25	50	1.0	500	600	0.15	0.08	300	0.85	MLF2012D68NMT
0.082	$\pm 20\%$	15	25	50	1.0	450	550	0.15	0.08	300	0.85	MLF2012D82NMT
0.1	$\pm 20, \pm 10\%$	20	30	25	1.0	400	500	0.15	0.10	300	0.85	MLF2012DR10□*2T
0.12	$\pm 20, \pm 10\%$	20	30	25	1.0	360	450	0.20	0.12	300	0.85	MLF2012DR12□T
0.15	$\pm 20, \pm 10\%$	20	30	25	1.0	320	410	0.20	0.13	300	0.85	MLF2012DR15□T
0.18	$\pm 20, \pm 10\%$	20	30	25	1.0	280	370	0.25	0.15	300	0.85	MLF2012DR18□T
0.22	$\pm 20, \pm 10\%$	20	30	25	1.0	250	330	0.30	0.16	250	0.85	MLF2012DR22□T
0.27	$\pm 20, \pm 10\%$	20	30	25	1.0	220	300	0.35	0.18	250	0.85	MLF2012DR27□T
0.33	$\pm 20, \pm 10\%$	20	30	25	1.0	200	270	0.40	0.23	250	0.85	MLF2012DR33□T
0.39	$\pm 20, \pm 10\%$	25	35	25	1.0	180	250	0.45	0.25	200	0.85	MLF2012DR39□T
0.47	$\pm 20, \pm 10\%$	25	35	25	1.0	160	230	0.50	0.25	200	1.25	MLF2012DR47□T
0.56	$\pm 20, \pm 10\%$	25	35	25	1.0	150	210	0.55	0.30	150	1.25	MLF2012DR56□T
0.68	$\pm 20, \pm 10\%$	25	35	25	1.0	140	190	0.60	0.35	150	1.25	MLF2012DR68□T
0.82	$\pm 20, \pm 10\%$	25	35	25	1.0	130	170	0.65	0.40	150	1.25	MLF2012DR82□T
1	$\pm 20, \pm 10\%$	45	55	10	1.0	120	160	0.30	0.15	80	0.85	MLF2012A1R0□T
1.2	$\pm 20, \pm 10\%$	45	55	10	1.0	110	150	0.35	0.15	80	0.85	MLF2012A1R2□T
1.5	$\pm 20, \pm 10\%$	45	60	10	1.0	100	140	0.40	0.18	80	0.85	MLF2012A1R5□T
1.8	$\pm 20, \pm 10\%$	45	60	10	1.0	90	130	0.45	0.20	80	0.85	MLF2012A1R8□T
2.2	$\pm 20, \pm 10\%$	45	60	10	1.0	80	120	0.50	0.22	50	0.85	MLF2012A2R2□T
2.7	$\pm 20, \pm 10\%$	45	70	10	1.0	70	100	0.55	0.25	50	1.25	MLF2012A2R7□T
3.3	$\pm 20, \pm 10\%$	45	70	10	1.0	60	90	0.60	0.28	50	1.25	MLF2012A3R3□T
3.9	$\pm 20, \pm 10\%$	45	70	10	1.0	55	80	0.65	0.30	30	1.25	MLF2012A3R9□T
4.7	$\pm 20, \pm 10\%$	45	70	10	1.0	50	70	0.70	0.35	30	1.25	MLF2012A4R7□T
5.6	$\pm 20, \pm 10\%$	50	75	4	0.1	45	65	0.60	0.30	15	1.25	MLF2012E5R6□T
6.8	$\pm 20, \pm 10\%$	50	75	4	0.1	40	60	0.65	0.32	15	1.25	MLF2012E6R8□T
8.2	$\pm 20, \pm 10\%$	50	75	4	0.1	35	55	0.70	0.35	15	1.25	MLF2012E8R2□T
10	$\pm 20, \pm 10\%$	50	75	2	0.1	30	50	0.80	0.40	15	1.25	MLF2012E100□T
12	$\pm 20, \pm 10\%$	50	75	2	0.1	25	45	0.90	0.50	15	1.25	MLF2012E120□T
15	$\pm 20, \pm 10\%$	30	45	1	0.1	22	40	0.70	0.35	5	1.25	MLF2012C150□T
18	$\pm 20, \pm 10\%$	30	45	1	0.1	20	38	0.80	0.38	5	1.25	MLF2012C180□T
22	$\pm 20, \pm 10\%$	30	45	1	0.1	18	35	0.90	0.45	5	1.25	MLF2012C220□T
27	$\pm 20, \pm 10\%$	30	45	1	0.1	17	33	1.00	0.50	5	1.25	MLF2012C270□T
33	$\pm 20, \pm 10\%$	30	45	0.4	0.1	15	28	1.10	0.55	5	1.25	MLF2012C330□T
39	$\pm 20, \pm 10\%$	35	55	2	0.1	13	23	2.40	1.30	4	1.25	MLF2012K390□T
47	$\pm 20, \pm 10\%$	35	55	2	0.1	11	20	2.70	1.60	4	1.25	MLF2012K470□T
56	$\pm 20, \pm 10\%$	35	55	2	0.1	10	18	2.80	1.80	4	1.25	MLF2012K560□T
68	$\pm 20, \pm 10\%$	25	45	1	0.1	9	16	2.90	2.00	2	1.25	MLF2012C680□T
82	$\pm 20, \pm 10\%$	25	45	1	0.1	8	14	3.00	2.40	2	1.25	MLF2012C820□T
100	$\pm 20, \pm 10\%$	25	45	1	0.1	7	12	3.10	2.50	2	1.25	MLF2012C101□T

*1 47N means for 47nH (0.047 μ H).*2 □: Please specify inductance tolerance, M($\pm 20\%$) or K($\pm 10\%$)

• Test equipment

Inductance, Q: Ag4294A-16034G

TYPICAL ELECTRICAL CHARACTERISTICS INDUCTANCE CHANGE vs. DC SUPERPOSITION CHARACTERISTICS

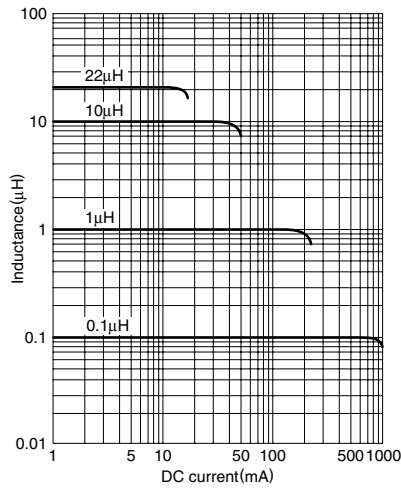

IMPEDANCE vs. FREQUENCY CHARACTERISTICS

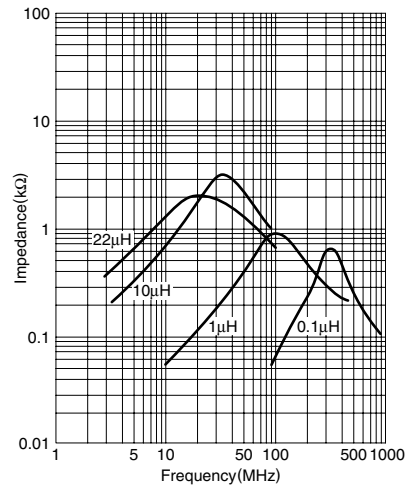

INDUCTANCE CHANGE vs. TEMPERATURE CHARACTERISTICS

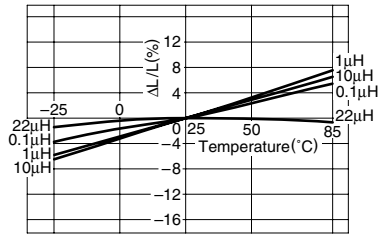

Q vs. FREQUENCY CHARACTERISTICS

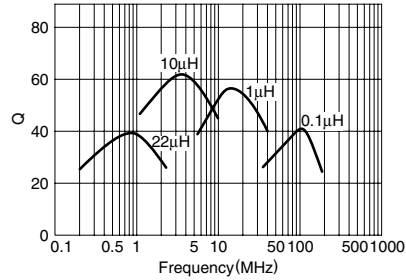

PACKAGING STYLES REEL DIMENSIONS

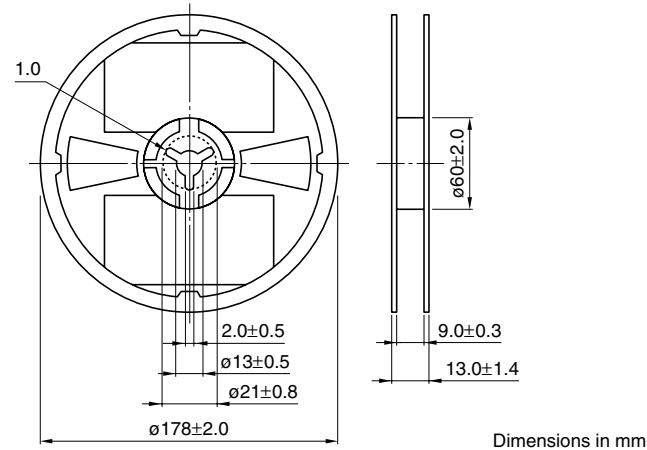

TAPE DIMENSIONS

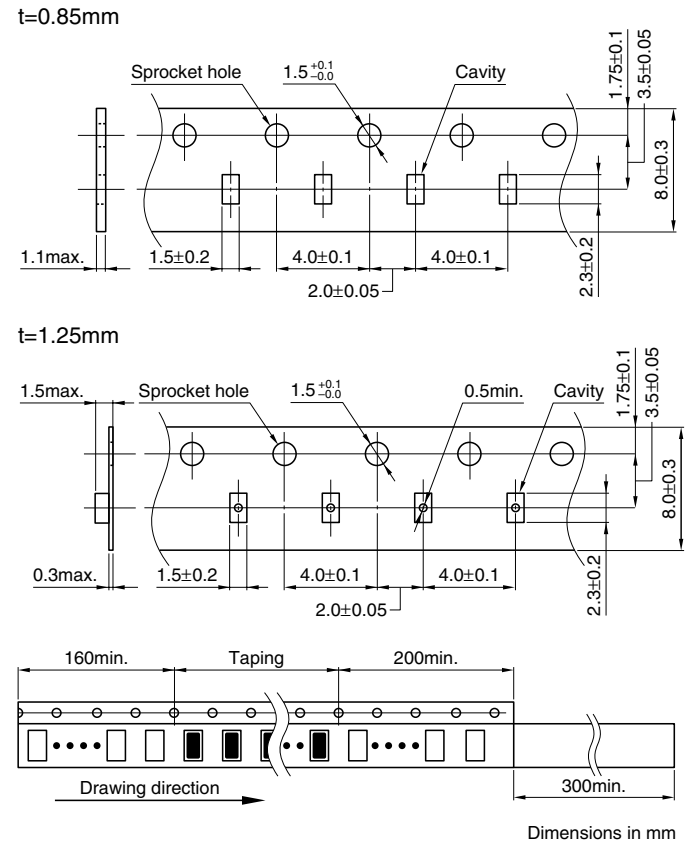

• All specifications are subject to change without notice.