

General Purpose Relays MKS

Exceptionally Reliable General Purpose Relay now available with Lockable Test Button

- IEC Rating of 7A 250 V AC 50/60 Hz, General use 100,000 cycles.
- Mechanical indicator standard for all models.
- Optional features include lockable test button, LED indicator, diode surge suppression, varistor, reverse polarity, and alternate wiring styles.
- UL (RU/cRU), CE and TUV approved.
- RoHS Compliant.



Features

Two-way Action Test Button (Models with Lockable Test Button)

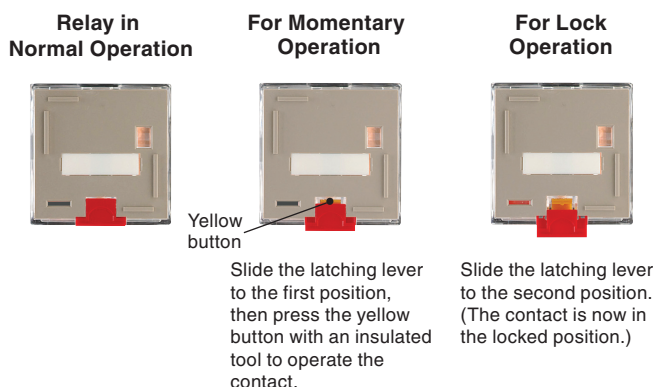

Note: The latching lever is Red for AC Coil versions and Blue for DC Coil versions.

Model Number Structure

Model Number Legend

MKS□□□□□□-□□
1 2 3 4 5 6 7

1. Contact Form

- 2: DPDT
- 3: 3PDT

2. Terminals

- P: Plug-in

3. Mechanical Indicator/Test Button

- Blank: Mechanical indicator
- I: Mechanical indicator and lockable test button

4. LED Indicator

- Blank: Standard
- N: LED indicator

5. Coil Polarity

- Blank: Standard
- 1: Reverse polarity (DC coil only)

6. Surge Absorption

- Blank: Standard
- D: Surge absorber diode (DC coil only)
- V: Surge absorber varistor (AC coil only)

7. Internal Connections DPDT

- Blank: Standard
- 2 or 5: Non-standard connections. (Refer to "Terminal Arrangement/Internal Connection (Bottom View)".)

8. Rated Voltage

(Refer to "Coil Ratings".)

Ordering Information

■ List of Models

Type	Terminals	Contact form	Internal connections (See note 3.)	With mechanical indicator	With mechanical indicator and lockable test button	Coil ratings
Basic Models	Plug-in	DPDT	Standard	MKS2P	MKS2PI	AC/DC
			Non Standard	MKS2P-2	MKS2PI-2	
		3PDT	Standard	MKS3P	MKS3PI	
			Non Standard	MKS3P-2	MKS3PI-2	
				MKS3P-5	MKS3PI-5	
		Models with LED Indicator (See note 2.)		DPDT	Standard	
Non Standard	MKS2PN(1)-2				MKS2PIN(1)-2	
3PDT	Standard			MKS3PN(1)	MKS3PIN(1)	
	Non Standard			MKS3PN(1)-2	MKS3PIN(1)-2	
				MKS3PN(1)-5	MKS3PIN(1)-5	
Models with Diode (See note 2.)				DPDT	Standard	MKS2P(1)-D
		Non Standard	MKS2P(1)-D-2		MKS2PI(1)-D-2	
		3PDT	Standard	MKS3P(1)-D	MKS3PI(1)-D	
			Non Standard	MKS3P(1)-D-2	MKS3PI(1)-D-2	
				MKS3P(1)-D-5	MKS3PI(1)-D-5	
		Models with LED Indicator and Diode		DPDT	Standard	MKS2PN-D
Non Standard	MKS2PN-D-2				MKS2PIN-D-2	
3PDT	Standard			MKS3PN-D	MKS3PIN-D	
	Non Standard			MKS3PN-D-2	MKS3PIN-D-2	
				MKS3PN-D-5	MKS3PIN-D-5	
Models with Varistor				DPDT	Standard	MKS2P-V
		Non Standard	MKS2P-V-2		MKS2PI-V-2	
		3PDT	Standard	MKS3P-V	MKS3PI-V	
			Non Standard	MKS3P-V-2	MKS3PI-V-2	
				MKS3P-V-5	MKS3PI-V-5	
		Models with LED Indicator and Varistor		DPDT	Standard	MKS2PN-V
Non Standard	MKS2PN-V-2				MKS2PIN-V-2	
3PDT	Standard			MKS3PN-V	MKS3PIN-V	
	Non Standard			MKS3PN-V-2	MKS3PIN-V-2	
				MKS3PN-V-5	MKS3PIN-V-5	

Note: 1. When ordering, add the rated voltage to the model number. Rated voltages are given in the coil ratings table in the specifications.

Example: MKS2P DC48

Rated voltage

2. The DC coil comes in two types: standard coil polarity and reverse coil polarity. Refer to *Terminal Arrangement and Internal Connections*.

Example: MKS3PN1-5 DC24

Reverse coil polarity

3. Refer to *Terminal Arrangement and Internal Connections* for all wiring diagrams.

■ 10A Sockets (Order Separately)

Item	Type	Model
Track-mounted Socket	8-pin	PF083A-E
	11-pin	PF113A-E
	8-pin	PF083A-D
	11-pin	PF113A-D
Hold-down Clip (For PF083A-E and PF113A-E)		PFC-A1

Specifications

■ Ratings

Coil Ratings

Rated voltage		Rated current		Coil resistance	Must operate voltage	Must release voltage	Max. voltage	Power consumption
		50 Hz	60 Hz					
AC	6 V	443 mA	385 mA	3.1 Ω	80% max. of rated voltage	30% min. of rated voltage at 60 Hz 25% min. of rated voltage at 50 Hz	110% of rated voltage	Approx. 2.3 VA at 60 Hz Approx. 2.7 VA at 50 Hz
	12 V	221 mA	193 mA	13.7 Ω				
	24 V	110 mA	96.3 mA	48.4 Ω				
	100 V	26.6 mA	23.1 mA	760 Ω				
	110 V	24.2 mA	21.0 mA	932 Ω				
	120 V	22.2 mA	19.3 mA	1,130 Ω				
	200 V	13.3 mA	11.6 mA	3,160 Ω				
	220 V	12.1 mA	10.5 mA	3,550 Ω				
	230 V	11.5 mA	10.0 mA	4,250 Ω				
	240 V	11.0 mA	9.6 mA	4,480 Ω				
DC	6 V	224 mA		26.7 Ω	15% min. of rated voltage			Approx. 1.4 W
	12 V	112 mA		107 Ω				
	24 V	55.8 mA		430 Ω				
	48 V	28.1 mA		1,710 Ω				
	100 V	13.5 mA		7,390 Ω				
	110 V	12.3 mA		8,960 Ω				
	125 V	10.8 mA		11,576 Ω				

- Note:**
1. The rated current and coil resistance are measured at a coil temperature of 23°C with tolerances of +15%/–20% for AC rated current and ±15% for DC coil resistance.
 2. Performance characteristic data are measured at a coil temperature of 23°C.
 3. The maximum voltage is one that is applicable instantaneously to the Relay coil at 23°C and not continuously.
 4. For DC-operated Relays with the LED indicator built-in, add an LED current of approx. 5 mA to the rated current.

Contact Ratings

Load		Resistive load (cosφ = 1)	Inductive load (p.f. = 0.4)
Contact mechanism		Single	
Contact material		AgSnIn	
Rated load	NO	10 A, 250 VAC 10A, 30 VDC	7 A, 250 VAC
	NC	5 A, 250 VAC 5 A, 30 VDC	
Rated carry current		10 A	
Max. switching voltage		250 VAC, 250 VDC	
Max. switching current		10 A	
Max. switching capacity	NO	2,500 VA/300 W	
	NC	1,250 VA/150 W	

■ Characteristics

Contact resistance	100 mΩ max.
Operate time	AC: 20 ms max. DC: 30 ms max.
Release time	20 ms max.(40 ms max. for built-in diode models)
Max. operating frequency	Mechanical: 18,000 operations/hr (no load) Electrical:1,800 operations/hr (at rated load)
Insulation resistance	100 MΩ min. (at 500 VDC)
Dielectric strength	2,500 VAC 50/60 Hz for 1 min. between coil and contacts 1,000 VAC 50/60 Hz for 1 min. between contacts of same polarity and terminals of the same polarity 2,500 VAC 50/60 Hz for 1 min. between current-carrying parts, non-current-carrying parts, and opposite polarity
Insulation method	Basic insulation
Impulse withstand voltage	4.5 kV between coil and contacts (with 1.2 × 50 μs impulse wave) 3.0 kV between contacts of different polarity (with 1.2 × 50 μs impulse wave)
Pollution degree	3
Rated insulation voltage	250 V
Vibration resistance	Destruction:10 to 55 Hz, 1.5 mm double amplitude Malfunction:10 to 55 Hz, 1.0 mm double amplitude
Shock resistance	Destruction:1,000 m/s ² (approx. 100 G) Malfunction:100 m/s ² (approx. 10 G)
Life expectancy	Mechanical: 5,000,000 operations min. Electrical:100,000 operations min.
Min. permissible load	10 mA at 1 VDC P level: λ ₆₀ =0.1 × 10 ⁻⁶ / ops
Ambient temperature	Operating: -40 to 60°C (with no icing or condensation)
Ambient humidity	Operating: 5% to 85%
Weight	Approx. 90 g

Note: 1. The values given above are initial values.
2. Ambient temperature of models with LED indicator is -25 to 60°C.

■ Approved Standards

UL Recognized (File No. E41515) -- Ambient Temp. = 40°C

Coil ratings	Contact ratings		Operations
6 to 110 VDC 6 to 240 VAC	N.O. contact	10 A, 250 V AC 50/60 Hz (Resistive) 10 A, 30 V DC (Resistive) 7 A, 250 V AC 50/60 Hz (General Use)	100,000
	N.C. contact	10 A, 250 V AC 50/60 Hz (Resistive) 10 A, 30 V DC (Resistive) 7 A, 250 V AC 50/60 Hz (General Use)	100,000

Note: 10A UL ratings are with no load on the other contact set.

CSA Certified (File No. LR35535)

Coil ratings	Number of Poles	Contact ratings	Operations
6 to 125 VDC 6 to 240 VAC	2	10 A, 250 V AC (Resistive) 10 A, 30 V DC (Resistive) 7 A, 250 V AC (General Use)	100,000
	3	10 A, 250 V AC (Resistive) Same Polarity 10 A, 30 V DC (Resistive) Same Polarity 7 A, 250 V AC (General Use) Same Polarity	100,000

IEC Standard/TUV Certification: IEC61810-1 (Certification No. R50104853)

Coil ratings	Contact ratings		Operations
6, 12, 24, 48, 100, 110 VDC 6, 12, 24, 100, 110, 200, 220, 240 VAC	N.O. contact	10 A, 250 V AC 50/60 Hz (Resistive) 10 A, 30 V DC (Resistive) 7 A, 250 V AC 50/60 Hz (General Use)	100,000
	N.C. contact	5 A, 250 V AC 50/60 Hz (Resistive) 5 A, 30 V DC (Resistive) 7 A, 250 V AC 50/60 Hz (General Use)	100,000

Note: Maximum carrying current per TUV Certification is 9 A when new MK-S relays are mounted in PF083A-E or PF113A-E Sockets.

Engineering Data

Reference Data

Maximum Switching Power

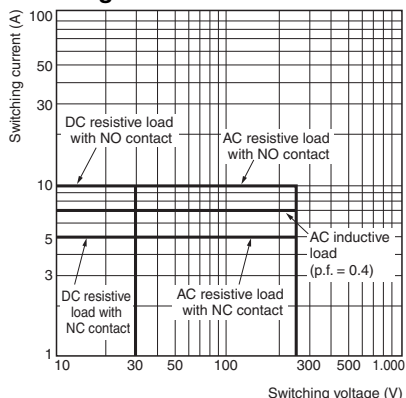

Rated Carry Current vs. Ambient Rated Temperature

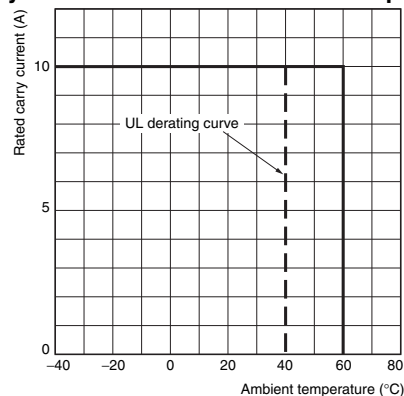

Note: The lower limit of the ambient operating temperature for models with built-in operation indicators is -25°C .

Dimensions

Note: All units are in millimeters unless otherwise indicated.

Models without Test Button

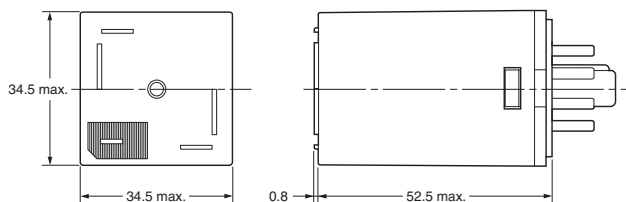



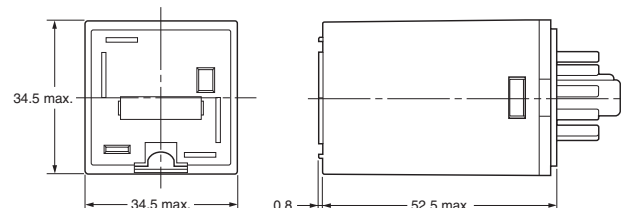

Models with Lockable Test Button

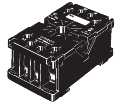
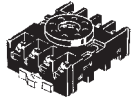

Track Mounted Sockets

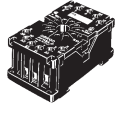
See below for Socket dimensions.

Poles	Finger-protection models		—
Maximum carry current	10 A		5 A
2 poles	PF083A-E 	PF083A-D 	PF083A 
3 poles	PF113A-E 	PF113A-D 	PF113A 

Note: If using the PF083A or PF113A Sockets, be sure the maximum carrying current is 5 A or less. When using finger-protection sockets, make sure the connecting wire terminals are Y-shaped.

PF083A-E (Conforming to EN 50022)

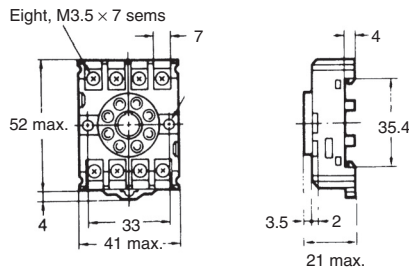

Terminal Arrangement

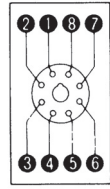

Mounting Holes

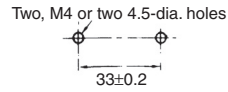

PF113A-E (Conforming to EN 50022)

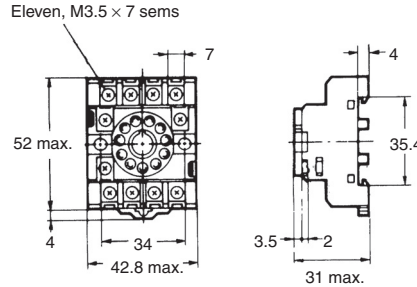

Terminal Arrangement

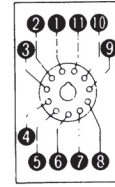

Mounting Holes

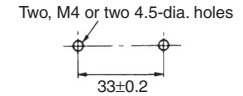

PF083A-D

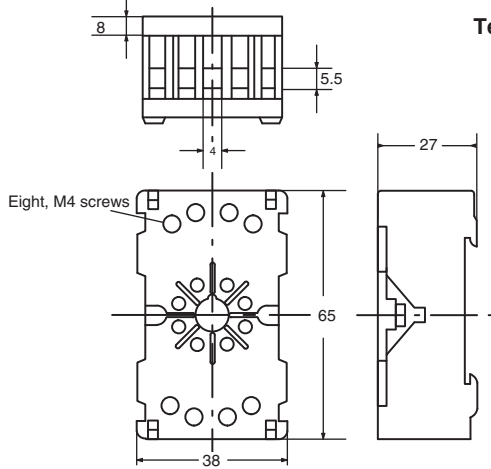

Terminal Arrangement

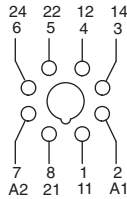

Mounting Holes

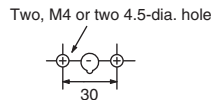

PF113A-D

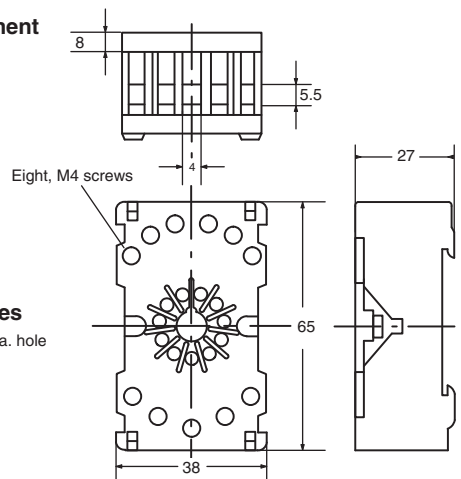

Terminal Arrangement

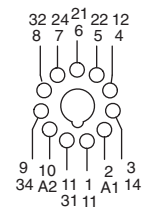

Mounting Holes

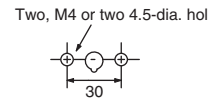

Hold-down Clips

PFC-A1
(2 pieces per set)

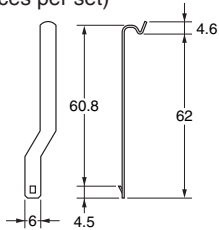

Mounting Height with Sockets

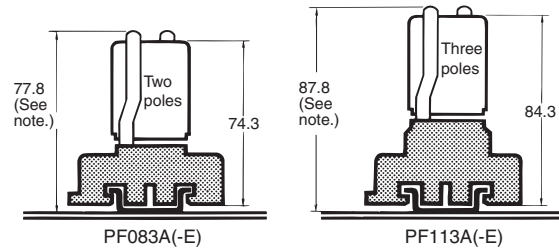

Note: PF083A(-E) and PF113A(-E) allow either track or screw mounting.

Mounting Tracks

PFP-100N, PFP-50N
(Conforming to EN 50022)

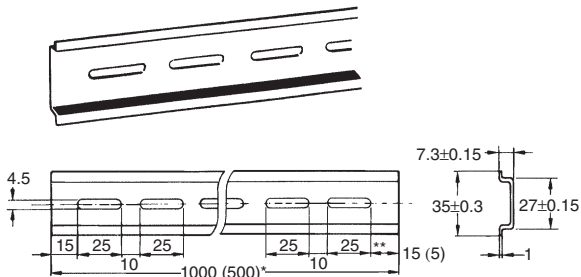

PFP-100N2
(Conforming to EN 50022)

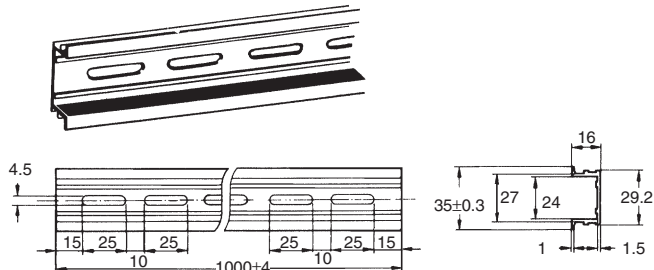

* The figure in parenthesis is for PFP-50N.

** A total of twelve 25 x 4.5 elliptic holes is provided with six holes cut from each track end at a pitch of 10 mm.

Terminal Arrangement/Internal Connection (Bottom View)

**Basic Models
(AC/DC Coil)**

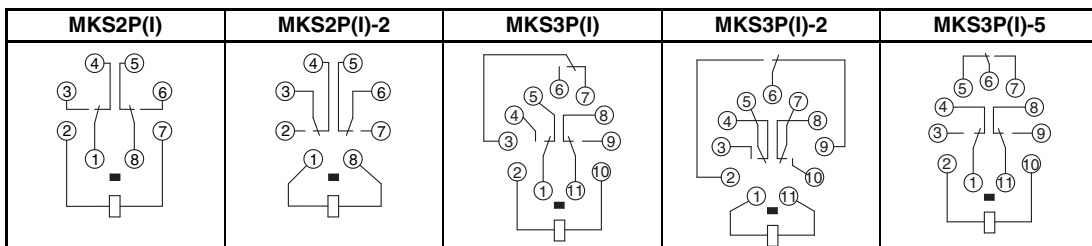

**LED Indicator Type
(AC Coil)**

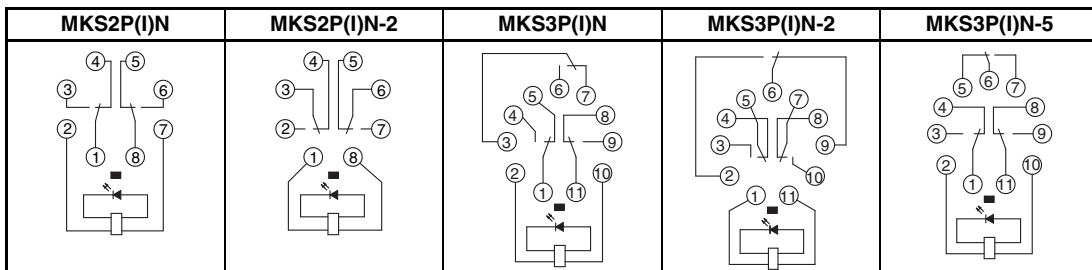

**LED Indicator Type
(DC Coil:
Standard Polarity)**

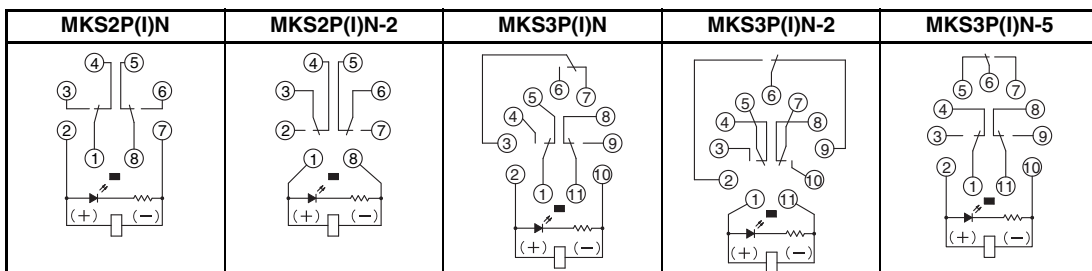

**LED Indicator Type
(DC Coil:
Reverse Polarity)**

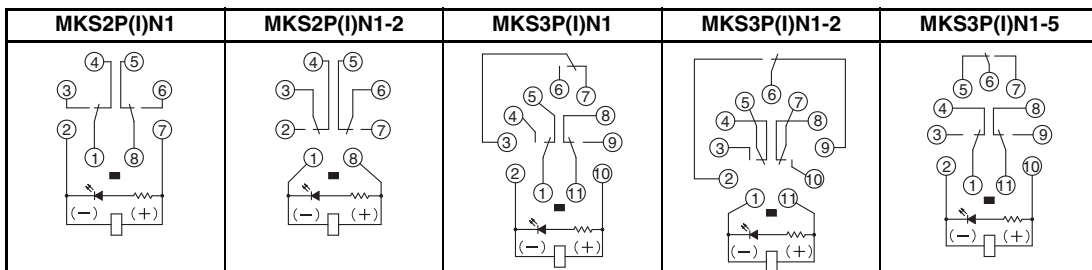

**Diode Type
(DC Coil:
Standard Polarity)**

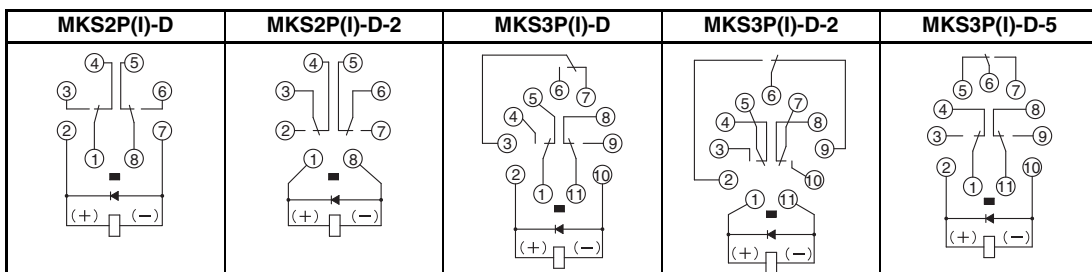

**Diode Type
(DC Coil:
Reverse Polarity)**

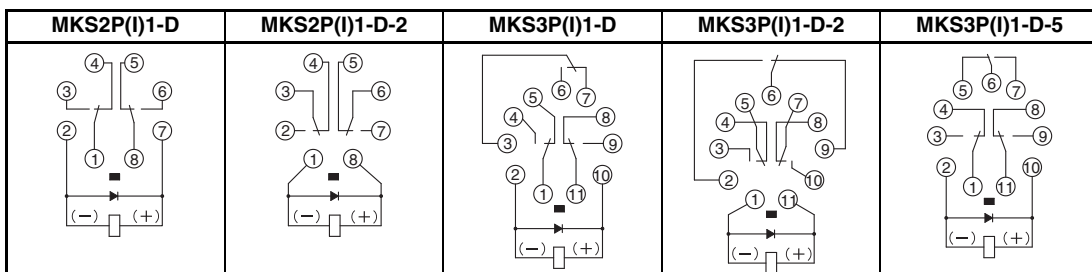

LED Indicator and Diode Type (DC Coil)

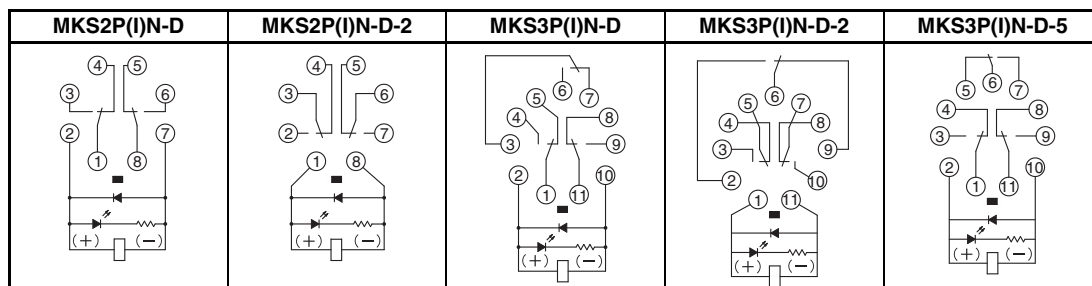

Varistor Type (AC Coil)

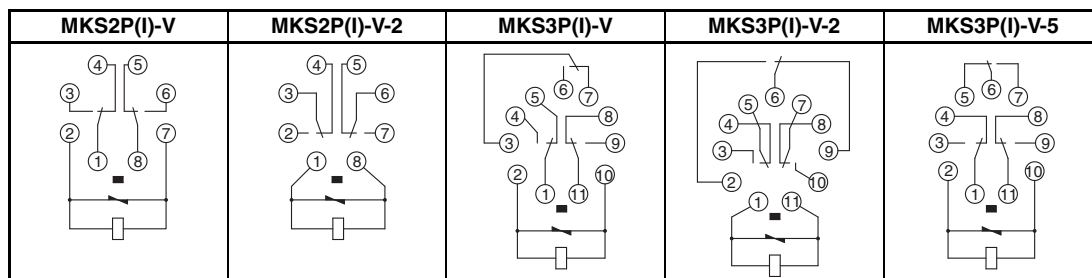

LED Indicator and Varistor Type (AC Coil)

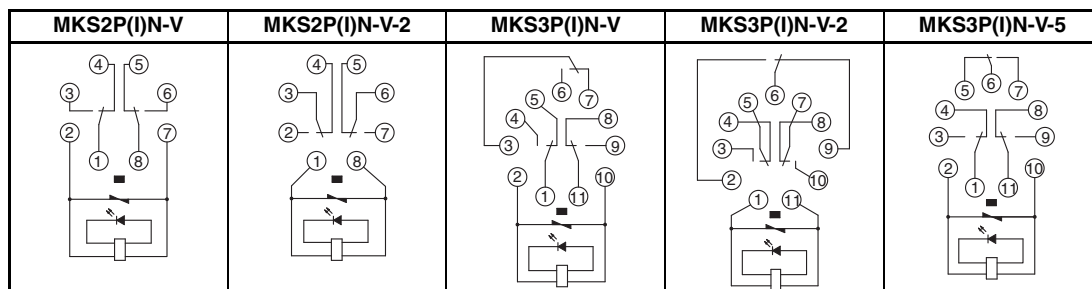

Safety Precautions

■ Safety Precautions for Correct Use

Installation

Recommend mounting MK-S Relay so that side with wiring diagram is facing down.

Handling

Check coil polarity when wiring LED Indicator and Diode Models.

Test Button

Do not use the test button for any purpose other than testing. Be sure not to touch the test button accidentally as this will turn the contacts ON. Before using the test button, confirm that circuits, the load, and any other connected item will operate safely.

Check that the test button is released before turning ON relay circuits.

If the test button is pulled out too forcefully, it may bypass the momentary testing position and go straight into the locked position.

Use an insulated tool when you operate the test button.

Models with test buttons or LED indicators fulfill the requirements for reinforced insulation between live parts and the front of cover only when the Relay is in a complete condition, i.e. with the nameplate, nameplate frame, test button, and slider in place. If any of these parts are removed, only the requirements for basic insulation are fulfilled.

A large grid of 20 columns and 30 rows of small squares, intended for taking notes or drawing diagrams. The grid is composed of thin, light gray lines forming a uniform pattern of small squares across the page.

All sales are subject to Omron Electronic Components LLC standard terms and conditions of sale, which can be found at http://www.components.omron.com/components/web/webfiles.nsf/sales_terms.html

ALL DIMENSIONS SHOWN ARE IN MILLIMETERS.

To convert millimeters into inches, multiply by 0.03937. To convert grams into ounces, multiply by 0.03527.

OMRON[®]

**OMRON ELECTRONIC
COMPONENTS LLC**

55 E. Commerce Drive, Suite B
Schaumburg, IL 60173

847-882-2288

OMRON ON-LINE

Global - <http://www.omron.com>

USA - <http://www.components.omron.com>

Cat. No. X301-E-1b

09/11

Specifications subject to change without notice

Printed in USA