

Parallel Type Air Gripper

MHZ Series

ø6, ø10, ø16, ø20, ø25, ø32, ø40

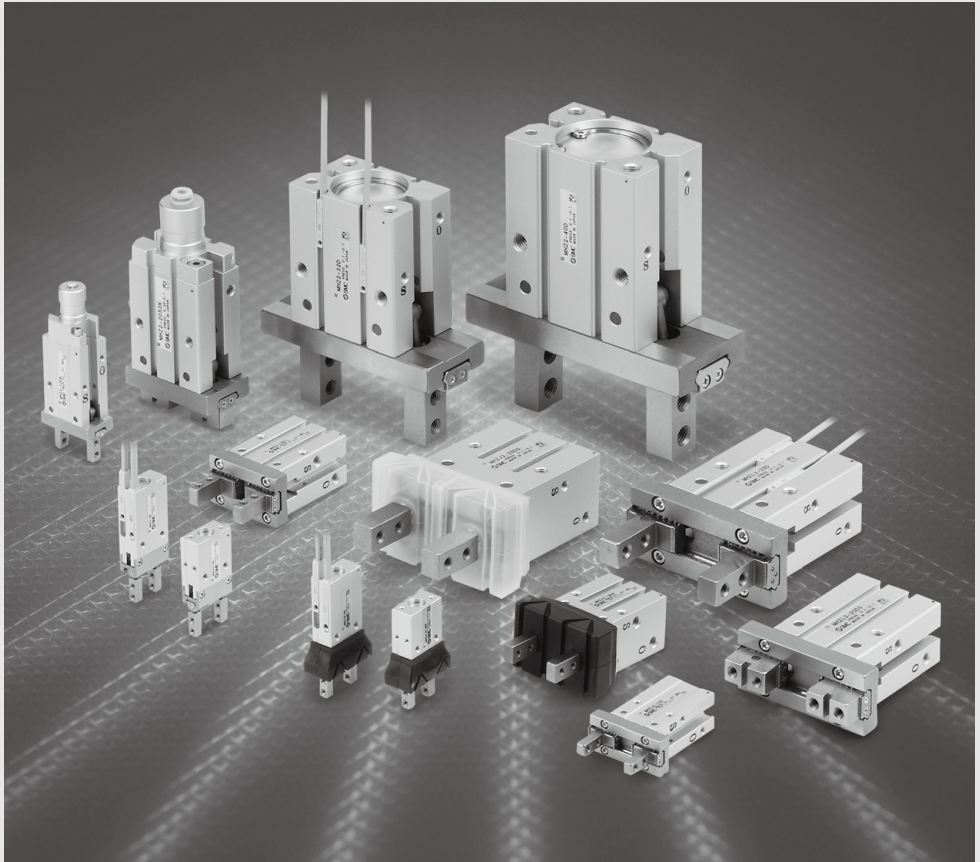

MHZ

MHF

MHL

MHR

MHK

MHS

MHC

MHT

MHY

MHW

-X

MRHQ

MA

D-

Integral linear guide used for high rigidity

• Repeatability: ± 0.01 mm

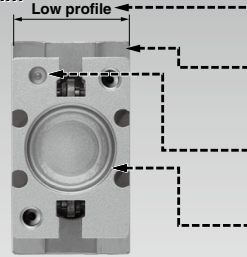
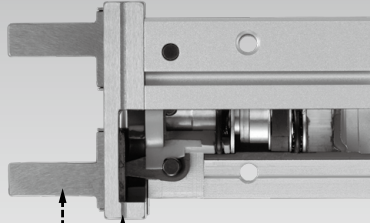
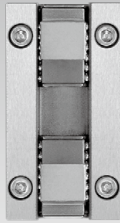

• Martensitic stainless steel

High degree of mounting flexibility

Can be mounted five ways from three directions.

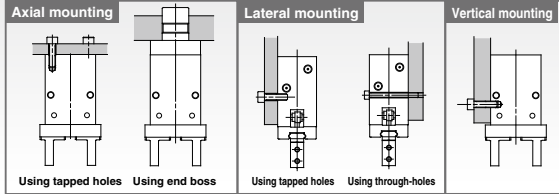

Finger positions can be selected.

(Standard type/MHZ2)

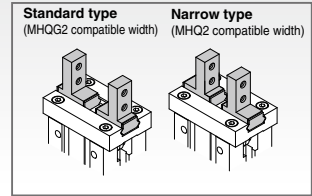

Body option/Piping port location

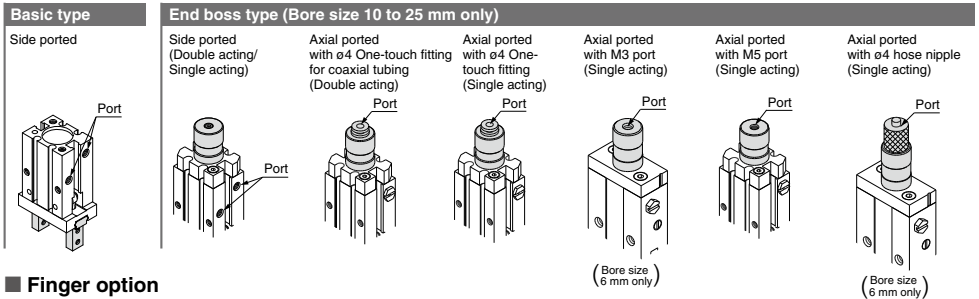

Finger option

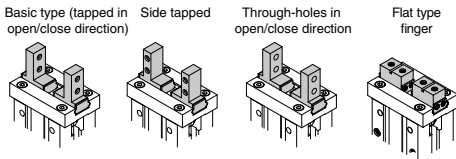

Compact Series (Without auto switch) **Page 398**

MHZJ2-6/MHZAJ2-6 (With dust cover)

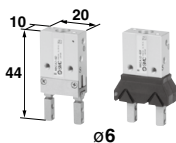

Standard Type **Page 408**

MHZ2 Series



and high precision

● **Body thickness tolerance:**
±0.05 mm

● **No guide protrusion in direction of body thickness**

● **Improved remounting accuracy**

Positioning dowel pin holes provided

● **Top mounting centering location**

Mounting is more secure with a depth 0.5 to 2 mm greater than current types.

Integral guide rail construction

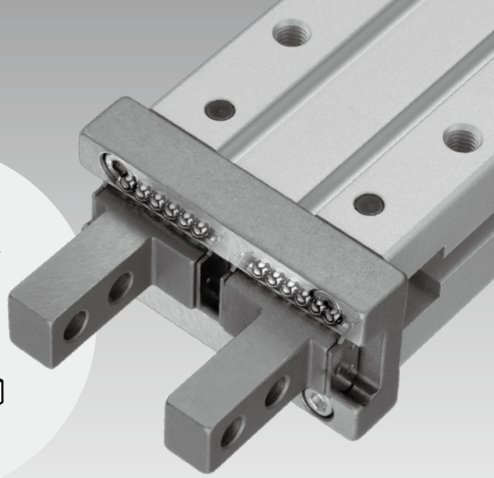
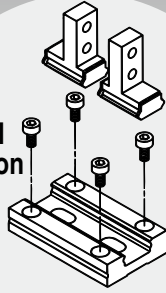

Long Stroke **Page 426**

MHZL2 Series

Accommodates diverse workpiece diameters with a single unit

- Nearly double the standard stroke
- Long stroke are also compact and lightweight

| Series | Opening/Closing stroke (mm) (Open-Closed) | Weight (g) | Body thickness (mm) |
|----------|--|------------|---------------------|
| MHZL2-10 | 8 (4) | 60 | 16.4 |
| MHZL2-16 | 12 (6) | 135 | 23.6 |
| MHZL2-20 | 18 (10) | 270 | 27.6 |
| MHZL2-25 | 22 (14) | 470 | 33.6 |

Values inside () are for standard MHZ2 series.



ø10 to ø25



With dust cover

Made to Order

ø10 to ø20

Page 436

With Dust Cover **Page 440**

MHZJ2 Series

- Prevents entry of chips, dust, water, etc.
- Prevents dispersion of grease and external leakage of dust.

Cover materials

- Chloroprene rubber (Black)
- Fluororubber (Black)
- Silicone rubber (White)



ø6

ø10 to ø25



ø32, ø40

Made to Order

Page 451

· Dust cover adhesion (Powerful adhesive used): -X77□

· Dust cover caulking (Silicone caulking agent used): -X78□

MHZ

MHF

MHL

MHR

MHK

MHS

MHC

MHT

MHY

MHW







-X□





MRHQ

MA

D-□

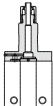
Series Variations

| Series | Bore size (mm) | Action | Body option | | | | | |
|---|------------------|---------------------------------|-------------|-------------|---|------------------------|--------------|--------------|
| | | | Basic type | | End boss type | | | |
| | | | Side ported | Side ported | With One-touch fitting for coaxial tubing | With One-touch fitting | With M3 port | With M5 port |
| Standard MHZA2-6  Page 398 | 6 | Double acting | ● | ● | | | | |
| | | Single acting (Normally open) | ● | ● | | ● | ● | |
| | | Single acting (Normally closed) | ● | ● | | ● | ● | |
| With dust cover MHZAJ2-6  Page 398 | 6 | Double acting | ● | ● | | | | |
| | | Single acting (Normally open) | ● | ● | | ● | ● | |
| | | Single acting (Normally closed) | ● | ● | | ● | ● | |
| Standard MHZ2  Page 408 | 6 | Double acting | ● | | | | | |
| | | Single acting (Normally open) | ● | | | | | |
| | | Single acting (Normally closed) | ● | | | | | |
| | 10, 16 20, 25 | Double acting | ● | ● | ● | | | |
| | | Single acting (Normally open) | ● | ● | | ● | | ● |
| | | Single acting (Normally closed) | ● | ● | | ● | | ● |
| | 32, 40 | Double acting | ● | | | | | |
| | | Single acting (Normally open) | ● | | | | | |
| | | Single acting (Normally closed) | ● | | | | | |
| Long stroke MHZL2  Page 426 | 10, 16 20, 25 | Double acting | ● | ● | ● | | | |
| | | Single acting (Normally open) | ● | ● | | ● | | ● |
| | | Single acting (Normally closed) | ● | ● | | ● | | ● |
| Long stroke With dust cover MHZL2  Page 436 | 10, 16 20 | Double acting | ● | | | | | |
| | | | | | | | | |
| With dust cover MHZJ2  Page 440 Page 451 | 6 | Double acting | ● | | | | | |
| | | Single acting (Normally open) | ● | | | | | |
| | | Single acting (Normally closed) | ● | | | | | |
| | 10, 16 20, 25 | Double acting | ● | ● | ● | | | |
| | | Single acting (Normally open) | ● | ● | | ● | | ● |
| | | Single acting (Normally closed) | ● | ● | | ● | | ● |
| | 32, 40 | Double acting | ● | | | | | |

| | | Finger option | | | |
|--|--|---|---|---|---|
| With hose nipple | | Basic type (tapped in open/close direction) | Side tapped | Through-holes in open/close direction | Flat type finger |
|  | |  |  |  |  |

| | |
|-------------------------------------|------|
| Made to Order common specifications | Page |
|-------------------------------------|------|

| | | | | | |
|--|---|---|---|---|---|
| | | ● | ● | ● | ● |
| | ● | ● | ● | ● | ● |
| | ● | ● | ● | ● | ● |

Page 398

* Availability varies depending on the model.
For details, refer to "Made to Order" on pages 725 to 748.

| | | | | | |
|--|--|---|---|---|---|
| | | ● | ● | ● | ● |
| | | ● | ● | ● | ● |
| | | ● | ● | ● | ● |
| | | ● | ● | ● | ● |
| | | ● | ● | ● | ● |

Page 408

- X4 Heat resistance (-10 to 100 °C)
- X5 Fluororubber seal
- X7 Closing direction spring assist
- X12 Opening direction spring assist
- X46 Built-in needle valve for finger speed control
- X50 Without magnet
- X51 MHQ2/MHQG2 compatible flat type fingers
- X53 Ethylene propylene rubber seal (EPDM)
- X56 Axial ported
- X63 Fluorine grease
- X64 Finger: Side tapped
- X65 Finger: Through-holes in opening/closing directions
- X77A Dust cover adhesion
- X77B Dust cover adhesion/Finger part only
- X78A Dust cover caulking
- X78B Dust cover caulking/Finger part only
- X79 Grease for food processing machines/Fluorine grease
- X79A Grease for food processing machines/Aluminum complex soap base grease
- X81A Special black chromium treatment is made on only the finger.
- X81B Special black chromium treatment is made on the finger and guide.

Page 426

| | | | | | |
|--|--|---|---|---|---|
| | | ● | ● | ● | ● |
| | | ● | ● | ● | ● |
| | | ● | ● | ● | ● |
| | | ● | ● | ● | ● |

Page 436

| | | | | | |
|--|--|---|--|--|--|
| | | ● | | | |
| | | ● | | | |
| | | ● | | | |
| | | ● | | | |

Page 440

| | | | | | |
|--|--|---|--|--|--|
| | | ● | | | |
| | | ● | | | |
| | | ● | | | |
| | | ● | | | |

Page 451

MHZ

MHF

MHL

MHR

MHK

MHS

MHC

MHT

Page 426

MHY

MHW

-X□

Page 436

MRHQ

MA

D-□

Page 440

MHZ Series Model Selection

Model Selection

Selection Procedure



Step 1 Confirmation of Gripping Force



Example

Workpiece mass:
0.1 kg

Gripping method:
External gripping

Gripping point distance:
L = 30 mm

Operating pressure:
0.4 MPa

Guidelines for the selection of the gripper with respect to workpiece mass

- Although conditions differ according to the workpiece shape and the coefficient of friction between the attachments and the workpiece, select a model that can provide a gripping force of 10 to 20 times the workpiece weight, or more.
(Note) For further details, refer to the model selection illustration.

- If high acceleration, deceleration or impact forces are encountered during motion, a further margin of safety should be considered.

Example) When it is desired to set the gripping force at 20 times or more above the workpiece weight.
Required gripping force = 0.1 kg x 20 x 9.8 m/s² = 19.6 N or more

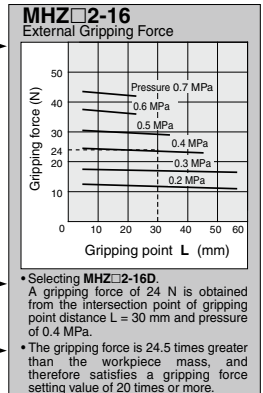

Model Selection Illustration

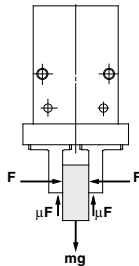

“Gripping force at least 10 to 20 times the workpiece weight”

The “10 to 20 times or more of the workpiece weight” recommended by SMC is calculated with a safety margin of $a = 4$, which allows for impacts that occur during normal transportation, etc.

| When $\mu = 0.2$ | When $\mu = 0.1$ |
|---|---|
| $F = \frac{mg}{2 \times 0.2} \times 4$ $= 10 \times mg$ | $F = \frac{mg}{2 \times 0.1} \times 4$ $= 20 \times mg$ |

10 x Workpiece weight

20 x Workpiece weight

Note) • Even in cases where the coefficient of friction is greater than $\mu = 0.2$, for reasons of safety, select a gripping force which is at least 10 to 20 times greater than the workpiece weight, as recommended by SMC.
• If high acceleration, deceleration or impact forces are encountered during motion, a further margin of safety should be considered.

When gripping a workpiece as in the figure to the left, and with the following definitions,

F: Gripping force (N)

μ : Coefficient of friction between the attachments and the workpiece

m: Workpiece mass (kg)

g: Gravitational acceleration (= 9.8 m/s²)

mg: Workpiece weight (N)

the conditions under which the workpiece will not drop are

$$2 \times \mu F > mg$$

↑ Number of fingers

and therefore,

$$F > \frac{mg}{2 \times \mu}$$

With “a” representing the extra margin, “F” is determined by the following formula:

$$F = \frac{mg}{2 \times \mu} \times a$$

Step 1 Effective Gripping Force: MHZ□2 Series/Double Acting/External Gripping Force

- Indication of effective gripping force

The effective gripping force shown in the graphs to the right is expressed as F, which is the thrust of one finger, when both fingers and attachments are in full contact with the workpiece as shown in the figure below.

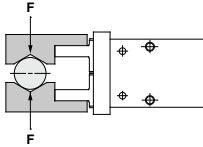

External Grip

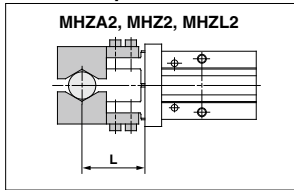

External Gripping Force

MHZ2-6D/MHZA2-6D

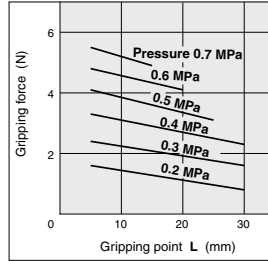

External Gripping Force

MHZ2-25D/MHZL2-25D

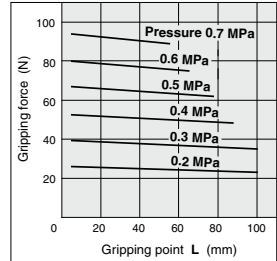

MHZ2-10D/MHZL2-10D

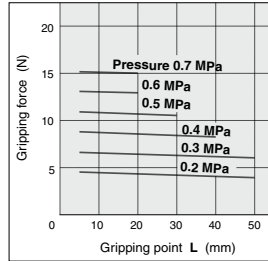

MHZ2-32D

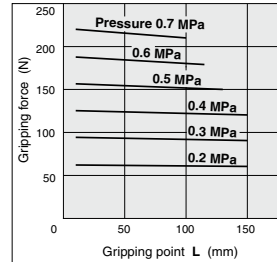

MHZ2-16D/MHZL2-16D

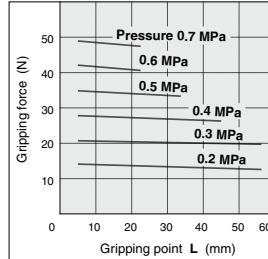

MHZ2-40D

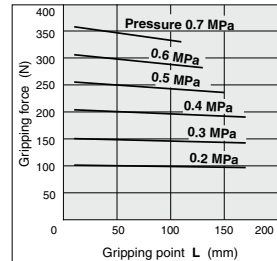

MHZ2-20D/MHZL2-20D

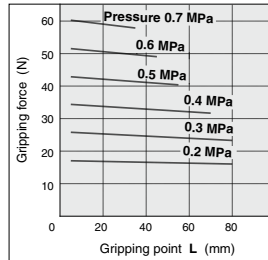

MHZ

MHF

MHL

MHR

MHK

MHS

MHC

MHT

MHY

MHW

-X□

MRHQ

MA

D-□

Model Selection

Step 1 Effective Gripping Force: MHZ□2 Series/Double Acting/Internal Gripping Force

- Indication of effective gripping force

The effective gripping force shown in the graphs to the right is expressed as F, which is the thrust of one finger, when both fingers and attachments are in full contact with the workpiece as shown in the figure below.

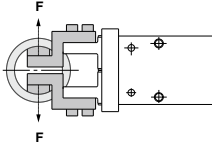

Internal Grip

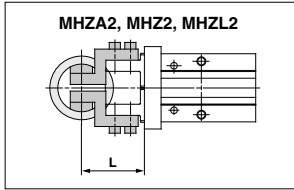

Internal Gripping Force

MHZ2-6D/MHZA2-6D

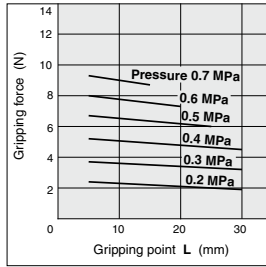

MHZ2-10D/MHZA2-10D

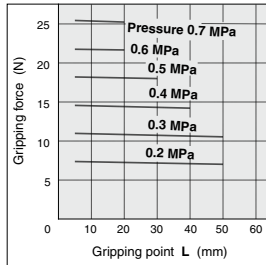

MHZ2-16D/MHZA2-16D

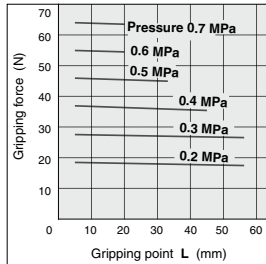

MHZ2-20D/MHZA2-20D

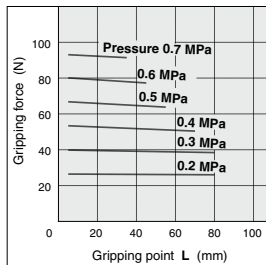

Internal Gripping Force

MHZ2-25D/MHZA2-25D

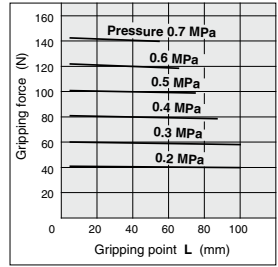

MHZ2-32D

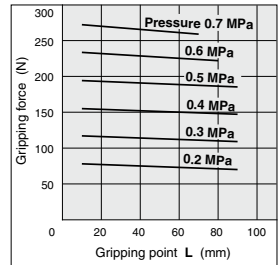

MHZ2-40D

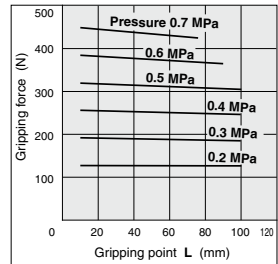

Step 1 Effective Gripping Force: MHZ□2 Series/Single Acting/External Gripping Force

- Indication of effective gripping force

The effective gripping force shown in the graphs to the right is expressed as F, which is the thrust of one finger, when both fingers and attachments are in full contact with the workpiece as shown in the figure below.

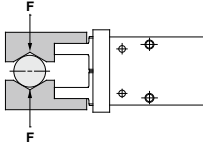

External Grip

MHZA2, MHZ2, MHZL2

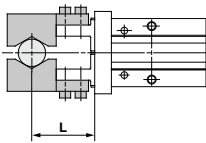

External Gripping Force

MHZ2-6S/MHZA2-6S

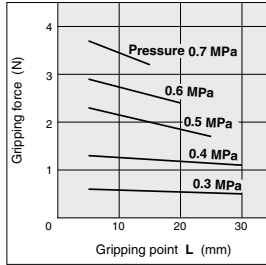

External Gripping Force

MHZ2-25S/MHZL2-25S

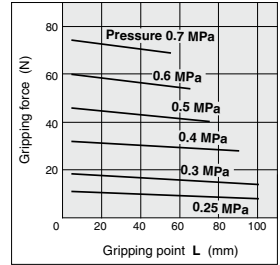

MHZ2-10S/MHZL2-10S

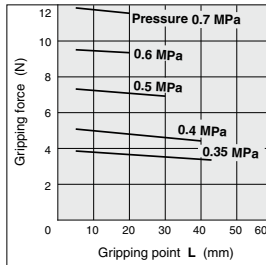

MHZ2-32S

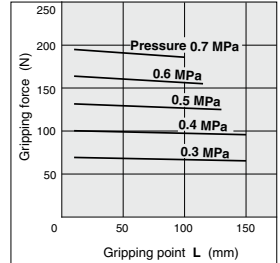

MHZ2-16S/MHZL2-16S

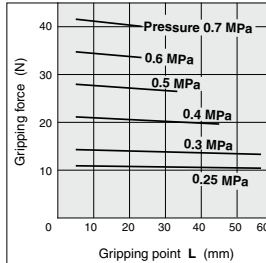

MHZ2-40S

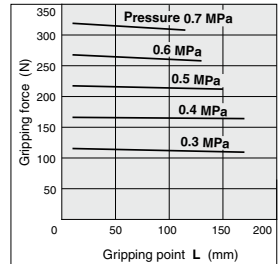

MHZ2-20S/MHZL2-20S

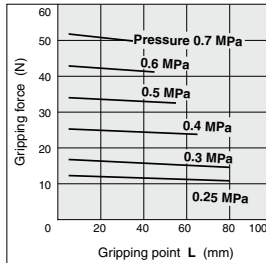

MHZ

MHF

MHL

MHR

MHK

MHS

MHC

MHT

MHY

MHW

-X□

MRHQ

MA

D-□

Model Selection

Step 1 Effective Gripping Force: MHZ□2 Series/Single Acting/Internal Gripping Force

- Indication of effective gripping force

The effective gripping force shown in the graphs to the right is expressed as F, which is the thrust of one finger, when both fingers and attachments are in full contact with the workpiece as shown in the figure below.

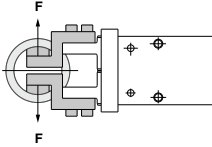

Internal Grip

MHA2, MHZ2, MHZL2

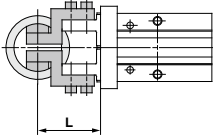

Internal Gripping Force

MHZ2-6C/MHZA2-6C

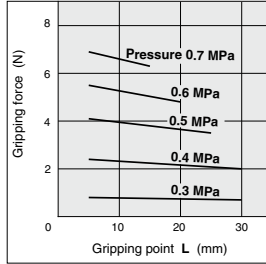

MHZ2-10C/MHZA2-10C

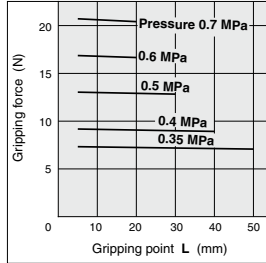

MHZ2-16C/MHZA2-16C

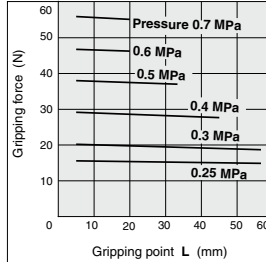

MHZ2-20C/MHZA2-20C

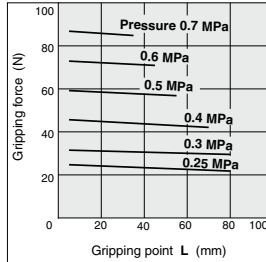

Internal Gripping Force

MHZ2-25C/MHZA2-25C

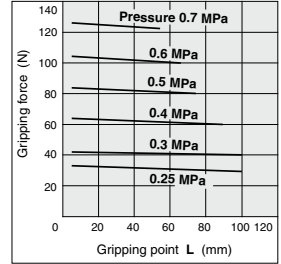

MHZ2-32C

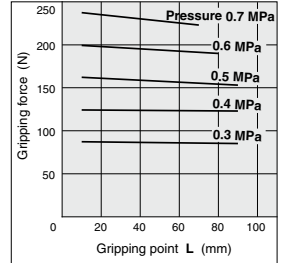

MHZ2-40C

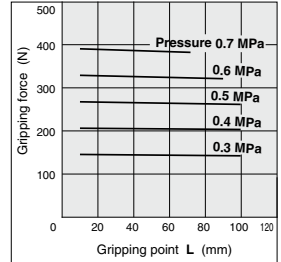

Step 1 Effective Gripping Force: MHZ□2 Series/Double Acting/External Gripping Force

- Indication of effective gripping force

The effective gripping force shown in the graphs to the right is expressed as F, which is the thrust of one finger, when both fingers and attachments are in full contact with the workpiece as shown in the figure below.

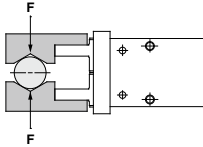

External Grip

MHZAJ2, MHZJ2, 11-MHZ2

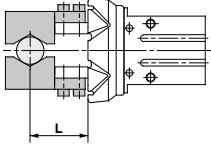

External Gripping Force

MHZJ2-6D/MHZAJ2-6D

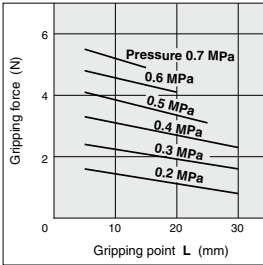

External Gripping Force

MHZJ2-25D/11-MHZ2-25D

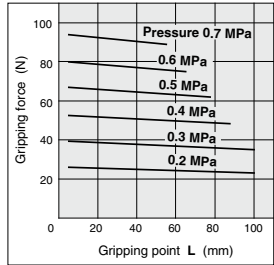

MHZJ2-10D/11-MHZ2-10D

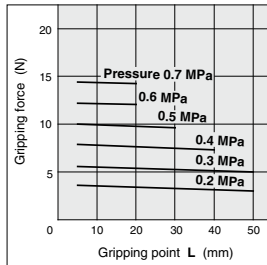

MHZJ2-16D/11-MHZ2-16D

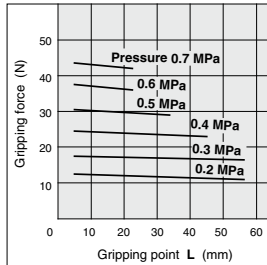

MHZJ2-20D/11-MHZ2-20D

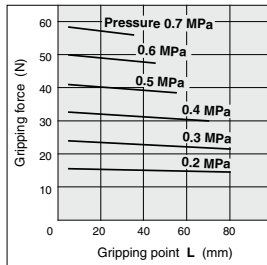

MHZ

MHF

MHL

MHR

MHK

MHS

MHC

MHT

MHY

MHW

-X□

MRHQ

MA

D-□

Model Selection

Step 1 Effective Gripping Force: MHZ□2 Series/Double Acting/Internal Gripping Force

- Indication of effective gripping force

The effective gripping force shown in the graphs to the right is expressed as F, which is the thrust of one finger, when both fingers and attachments are in full contact with the workpiece as shown in the figure below.

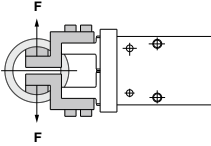

Internal Grip

MHZAJ2, MHZJ2, 11-MHZ2

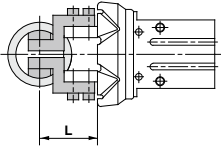

Internal Gripping Force

MHZJ2-6D/MHZAJ2-6D

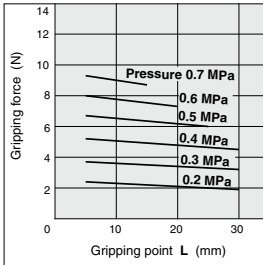

Internal Gripping Force

MHZJ2-25D/11-MHZ2-25D

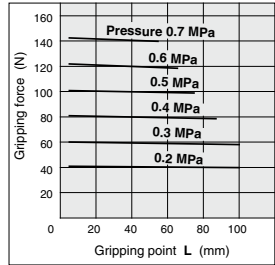

MHZJ2-10D/11-MHZ2-10D

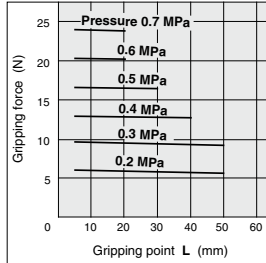

MHZJ2-16D/11-MHZ2-16D

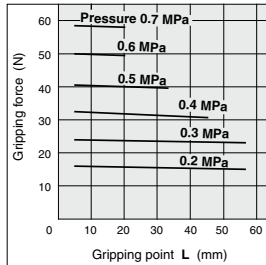

MHZJ2-20D/11-MHZ2-20D

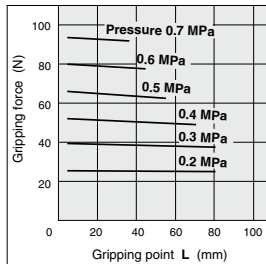

Step 1 Effective Gripping Force: MHZ□2 Series/Single Acting/External Gripping Force

- Indication of effective gripping force

The effective gripping force shown in the graphs to the right is expressed as F, which is the thrust of one finger, when both fingers and attachments are in full contact with the workpiece as shown in the figure below.

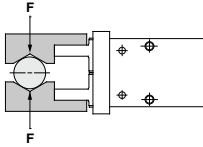

External Grip

MHZAJ2, MHZJ2

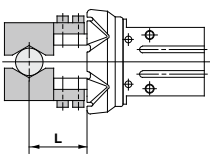

External Gripping Force

MHZJ2-6S/MHZAJ2-6S

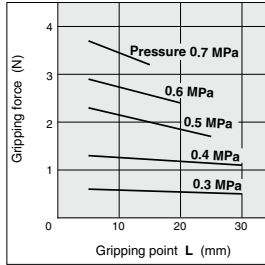

External Gripping Force

MHZJ2-25S

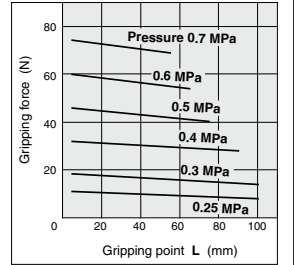

MHZJ2-10S

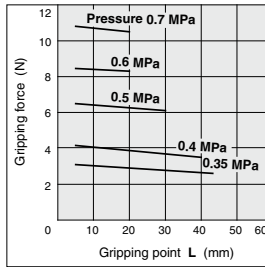

MHZJ2-16S

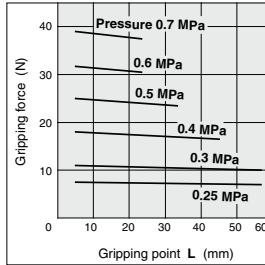

MHZJ2-20S

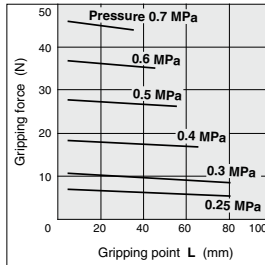

MHZ

MHF

MHL

MHR

MHK

MHS

MHC

MHT

MHY

MHW

-X□

MRHQ

MA

D-□

Model Selection

Step 1 Effective Gripping Force: MHZ□2 Series/Single Acting/Internal Gripping Force

- Indication of effective gripping force

The effective gripping force shown in the graphs to the right is expressed as F, which is the thrust of one finger, when both fingers and attachments are in full contact with the workpiece as shown in the figure below.

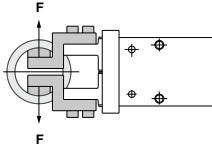

Internal Grip

MHZAJ2, MHZJ2

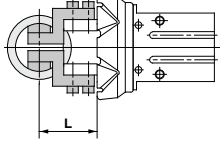

Internal Gripping Force

MHZJ2-6C/MHZAJ2-6C

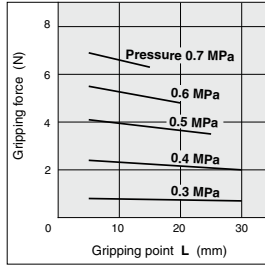

Internal Gripping Force

MHZJ2-25C

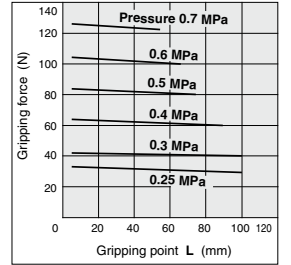

MHZJ2-10C

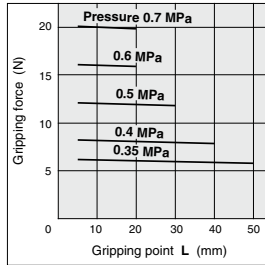

MHZJ2-16C

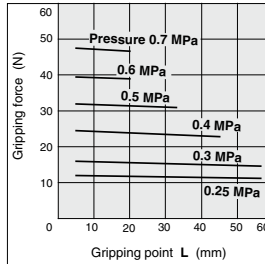

MHZJ2-20C

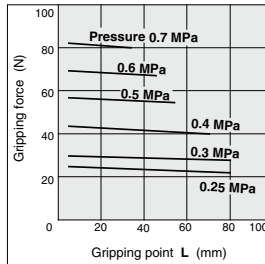

Step 2 Confirmation of Gripping Point: MHZ□ Series/External Grip

External Grip

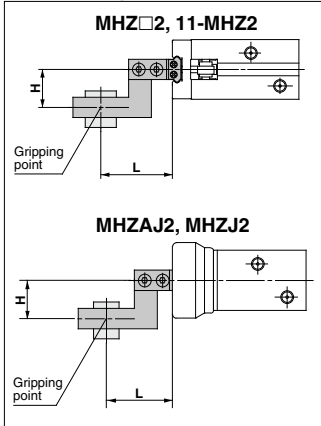

- The air gripper should be operated so that the workpiece gripping point "L" and the amount of overhang "H" stay within the range shown for each operating pressure given in the graphs to the right.
- If the workpiece gripping point goes beyond the range limits, this will have an adverse effect on the life of the air gripper.

External Grip

MHZ□2-6□

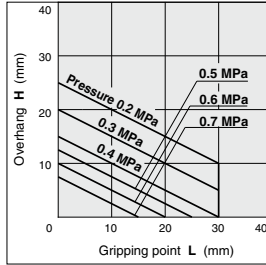

MHZ□2-10□/11-MHZ2-10□

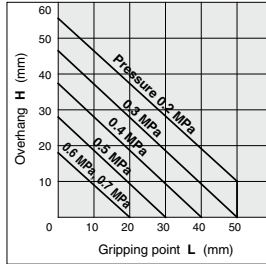

MHZ□2-16□/11-MHZ2-16□

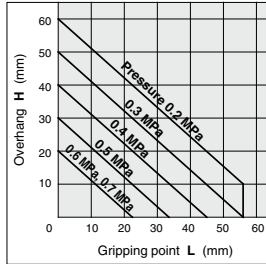

MHZ□2-20□/11-MHZ2-20□

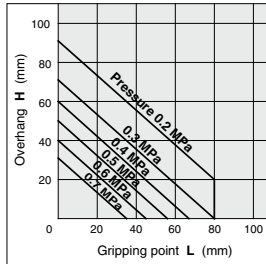

External Grip

MHZ□2-25□/11-MHZ2-25□

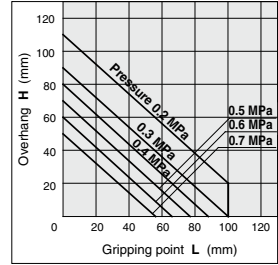

MHZ2-32□

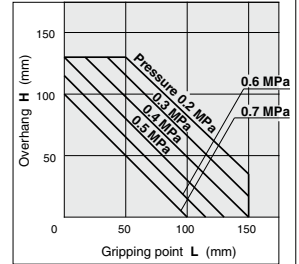

MHZ2-40□

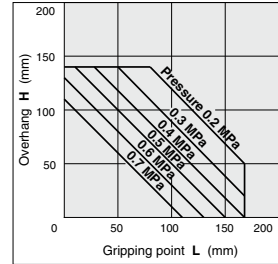

- MHZ**
- MHF**
- MHL**
- MHR**
- MHK**
- MHS**
- MHC**
- MHT**
- MHY**
- MHW**
- X□**
- MRHQ**
- MA**
- D-□**

Model Selection

Step 2 Confirmation of Gripping Point: MHZ□ Series/Internal Grip

Internal Grip

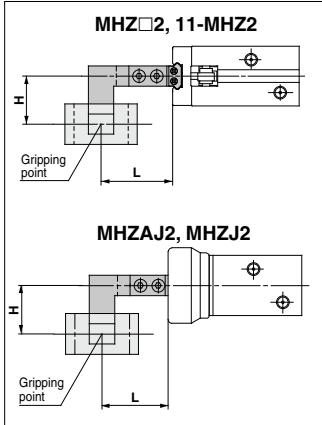

- The air gripper should be operated so that the workpiece gripping point "L" and the amount of overhang "H" stay within the range shown for each operating pressure given in the graphs to the right.
- If the workpiece gripping point goes beyond the range limits, this will have an adverse effect on the life of the air gripper.

Internal Grip

MHZ□2-6□

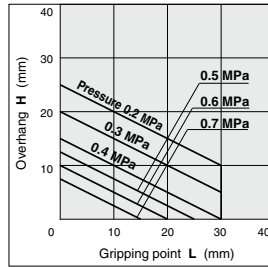

MHZ□2-10□/11-MHZ2-10□

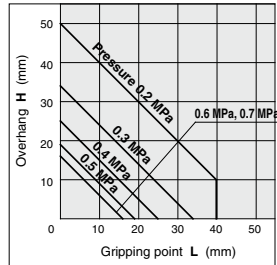

MHZ□2-16□/11-MHZ2-16□

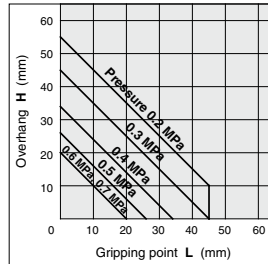

MHZ□2-20□/11-MHZ2-20□

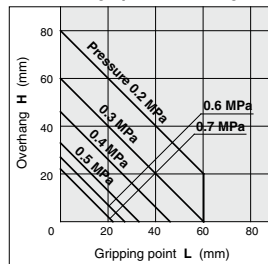

Internal Grip

MHZ□2-25□/11-MHZ2-25□

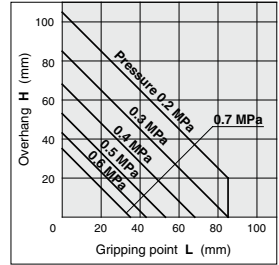

MHZ2-32□

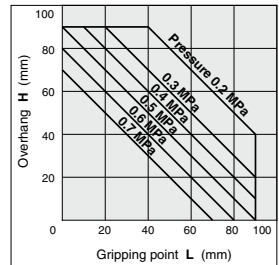

MHZ2-40□

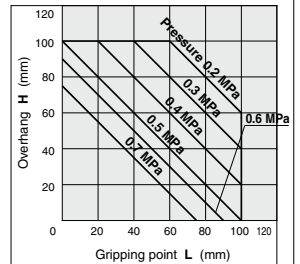

Step 3 Confirmation of External Force on Fingers: MHZ□2 Series

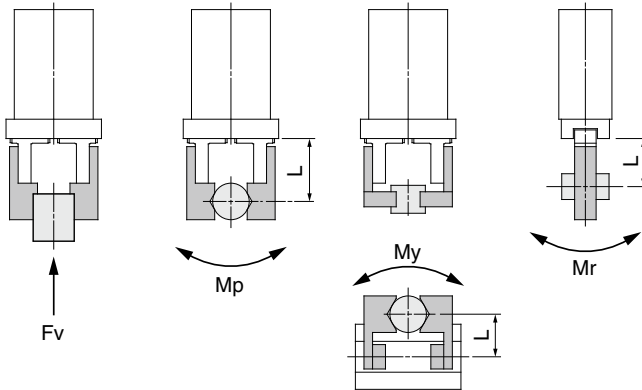

L: Distance to the point at which the load is applied (mm)

| Model | Allowable vertical load Fv (N) | Maximum allowable moment | | |
|----------|-----------------------------------|---------------------------|-------------------------|--------------------------|
| | | Pitch moment: Mp (N·m) | Yaw moment: My (N·m) | Roll moment: Mr (N·m) |
| MHZ□2-6 | 10 | 0.04 | 0.04 | 0.08 |
| MHZ□2-10 | 58 | 0.26 | 0.26 | 0.53 |
| MHZ□2-16 | 98 | 0.68 | 0.68 | 1.36 |
| MHZ□2-20 | 147 | 1.32 | 1.32 | 2.65 |
| MHZ□2-25 | 255 | 1.94 | 1.94 | 3.88 |
| MHZ□2-32 | 343 | 3 | 3 | 6 |
| MHZ□2-40 | 490 | 4.5 | 4.5 | 9 |

Note) Values for load and moment in the table indicate static values.

| Calculation of allowable external force (when moment load is applied) | Calculation example |
|--|---|
| $\text{Allowable load } F \text{ (N)} = \frac{M \text{ (maximum allowable moment)(N·m)}}{L \times 10^{-3}}$ <p>(*: Constant for unit conversion)</p> | <p>When a static load of $f = 10 \text{ N}$ is operating, which applies pitch moment to point $L = 30 \text{ mm}$ from the MHZ□2-16D guide. Therefore, it can be used.</p> $\text{Allowable load } F = \frac{0.68}{30 \times 10^{-3}} = 22.7 \text{ (N)}$ <p>Load $f = 10 \text{ (N)} < 22.7 \text{ (N)}$</p> |

MHZ

MHF

MHL

MHR

MHK

MHS

MHC

MHT

MHY

MHW

-X□

MRHQ

MA

D-□

Specifications



| | | Fluid | Air |
|-------------------------------|---------------|-----------------|-----------------------------|
| Operating pressure | Double acting | | 0.15 to 0.7 MPa |
| | Single acting | Normally open | 0.3 to 0.7 MPa |
| | | Normally closed | |
| Ambient and fluid temperature | | | -10 to 60°C |
| Repeatability | | | ±0.01 mm |
| Max. operating frequency | | | 180 c.p.m. |
| Lubrication | | | Not required |
| Action | | | Double acting/Single acting |

* Use the gripper with dust cover when used in a place where there may be dust.

Symbol

Double acting:
Internal grip

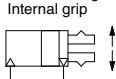

Double acting:
External grip

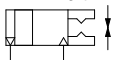

Single acting/
Normally closed:
Internal grip

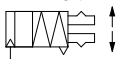

Single acting/
Normally open:
External grip

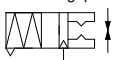

Model

| Action | Model | Bore size (mm) | Gripping force ^{Note)} | | Opening/Closing (Both sides) (mm) | Weight (g) | |
|---------------|-----------------|----------------|---|----------|-----------------------------------|------------|----|
| | | | Gripping force per finger Effective value (N) | | | | |
| | | | External | Internal | | | |
| Double acting | MHZA2-6D | 6 | 3.3 | 6.1 | 4 | 26 | |
| | MHZAJ2-6D | 6 | | | 4 | 27 | |
| Single acting | Normally closed | MHZA2-6S | 1.9 | — | 4 | 26 | |
| | | MHZAJ2-6S | | | 6 | 4 | 27 |
| | Normally open | MHZA2-6C | 6 | — | 3.7 | 4 | 26 |
| | | MHZAJ2-6C | | | | 6 | 4 |

Note) Values based on pressure of 0.5 MPa, gripping point L = 20 mm, at center of stroke.

Option

● Body Option/End Boss Type

| Symbol | Piping port location | Type of piping port | Applicable model | |
|--------|----------------------|---------------------------|------------------|---------------|
| | | MHZA2-6/MHZAJ2-6 | Double acting | Single acting |
| Nil | Basic type | M3 x 0.5 | ● | ● |
| E | Side ported | M3 x 0.5 | ● | ● |
| K | Axial ported | With ø4 One-touch fitting | — | ● |
| H | | With ø4 hose nipple | — | ● |
| M | | M3 x 0.5 | — | ● |



Made to Order
[Click here for details](#)

| Symbol | Specifications/Description |
|--------|--|
| -X4 | Heat resistance (100°C) |
| -X5 | Fluororubber seal |
| -X12 | Opening direction spring assist |
| -X53 | EPDM seal/Fluorine grease |
| -X56 | Axial ported type |
| -X63 | Fluorine grease |
| -X64 | Finger: Side tapped mounting |
| -X65 | Finger: Through-hole mounting |
| -X79 | Grease for food processing machines, Fluorine grease |
| -X79A | Grease for food processing machines |
| -X81A | Anti-corrosive treatment of finger |
| -X81B | Anti-corrosive treatment of finger and guide |

Moisture Control Tube IDK Series



When operating an actuator with a small diameter and a short stroke at a high frequency, the dew condensation (water droplet) may occur inside the piping depending on the conditions.

Simply connecting the moisture control tube to the actuator will prevent dew condensation from occurring. For details, refer to [the IDK series in the Best Pneumatics No. 6](#).

MHZ

MHF

MHL

MHR

MHK

MHS

MHC

MHT

MHY

MHW

-X□

MRHQ

MA

D-□

MHZA2-6/MHZAJ2-6 Series

Construction: Standard Type MHZA2-6

Double acting/With fingers open

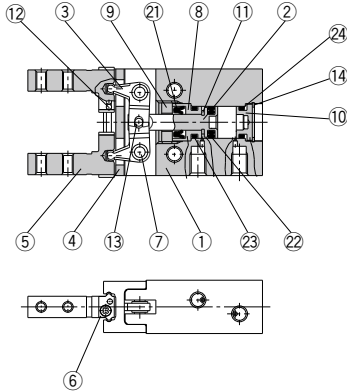

Single acting/Normally open

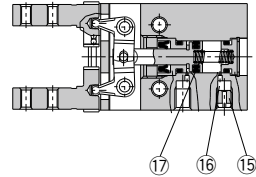

Single acting/Normally closed

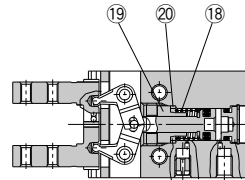

Double acting/With fingers closed

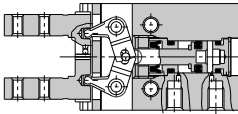

Component Parts

| No. | Description | Material | Note |
|-----|----------------|----------------------------------|---------------------------|
| 1 | Body | Aluminum alloy | Hard anodized |
| 2 | Piston | Stainless steel | |
| 3 | Lever | Stainless steel | Heat treated |
| 4 | Guide | Stainless steel | Heat treated |
| 5 | Finger | Stainless steel | Heat treated |
| 6 | Roller stopper | Stainless steel | |
| 7 | Lever shaft | Stainless steel | Nitriding |
| 8 | Holder | Brass | Electroless nickel plated |
| 9 | Holder lock | Stainless steel | |
| 10 | Cap | Aluminum alloy | Clear anodized |
| 11 | Bumper | Urethane rubber | |
| 12 | Steel balls | High carbon chrome bearing steel | |
| 13 | Needle roller | High carbon chrome bearing steel | |

Component Parts

| No. | Description | Material | Note |
|-----|-----------------------|-----------------------------|---------------------------|
| 14 | Type C retaining ring | Carbon steel | Phosphate coated |
| 15 | Exhaust plug | Brass | Electroless nickel plated |
| 16 | Exhaust filter | Polyvinyl formal | |
| 17 | N.O. spring | Stainless steel spring wire | |
| 18 | N.C. spring | Stainless steel spring wire | |
| 19 | N.C. holder | Brass | Electroless nickel plated |
| 20 | N.C. spacer | Stainless steel | |
| 21 | Rod seal | NBR | |
| 22 | Piston seal | NBR | |
| 23 | Gasket | NBR | |
| 24 | Gasket | NBR | |

Replacement Parts

| Description | | MHZA2-6□ | Main parts |
|-------------------|------------|---|--|
| Finger assembly | | Please contact SMC to replace the seal kit and finger assembly. | |
| End boss assembly | MHZA2-6□□H | MHZA-A0607 | Main body of adaptor Mounting screw for adaptor Seal |
| | MHZA2-6□□K | MHZA-A0608 | |
| | MHZA2-6□□M | MHZA-A0609 | |
| | MHZA2-6□□E | MHZA-A0610 | |

* The end boss assembly other than type E should be mounted on the special body.

Replacement part/Grease pack part no.: GR-S-010 (10 g)

Construction: With Dust Cover MHZAJ2-6

Double acting/With fingers open

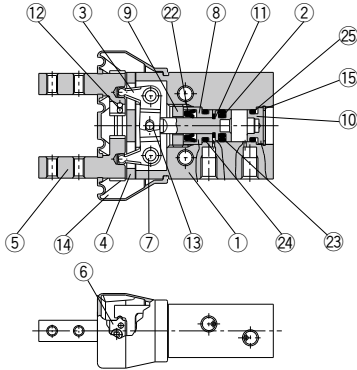

Single acting/Normally open

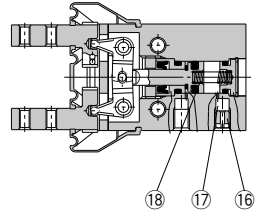

Single acting/Normally closed

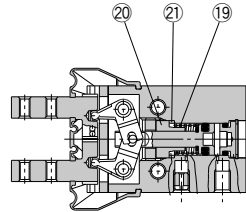

Double acting/With fingers closed

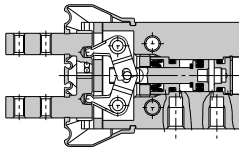

Component Parts

| No. | Description | Material | Note |
|-----|-----------------------|----------------------------------|---------------------------|
| 1 | Body | Aluminum alloy | Hard anodized |
| 2 | Piston | Stainless steel | |
| 3 | Lever | Stainless steel | Heat treated |
| 4 | Guide | Stainless steel | Heat treated |
| 5 | Finger | Stainless steel | Heat treated |
| 6 | Roller stopper | Stainless steel | |
| 7 | Lever shaft | Stainless steel | Nitriding |
| 8 | Holder | Brass | Electroless nickel plated |
| 9 | Holder lock | Stainless steel | |
| 10 | Cap | Aluminum alloy | Clear anodized |
| 11 | Bumper | Urethane rubber | |
| 12 | Steel balls | High carbon chrome bearing steel | |
| 13 | Needle roller | High carbon chrome bearing steel | |

Component Parts

| No. | Description | Material | Note |
|-----|------------------------------|-----------------------------|---------------------------|
| 14 | Dust cover | CR | Chloroprene rubber |
| | | FKM | Fluororubber |
| | | Silicone rubber | |
| 15 | Type C retaining ring | Carbon steel | Phosphate coated |
| 16 | Exhaust plug | Brass | Electroless nickel plated |
| 17 | Exhaust filter | Polyvinyl formal | |
| 18 | N.O. spring | Stainless steel spring wire | |
| 19 | N.C. spring | Stainless steel spring wire | |
| 20 | N.C. holder | Brass | Electroless nickel plated |
| 21 | N.C. spacer | Stainless steel | |
| 22 | Rod seal | NBR | |
| 23 | Piston seal | NBR | |
| 24 | Gasket | NBR | |
| 25 | Gasket | NBR | |

Replacement Parts

| Description | | MHZAJ2-6 | Main parts |
|--------------------------|------------|--|--|
| Seal kit | | Please contact SMC to replace the seal kit. | |
| Dust cover | Material | MHZAJ2-J6 | (14) |
| | CR | MHZAJ2-J6F | |
| | FKM | MHZAJ2-J6S | |
| Finger assembly | | Please contact SMC to replace the finger assembly. | |
| End boss assembly | MHZA2-6□□H | MHZA-A0607 | Main body of adaptor Mounting screw for adaptor Seal |
| | MHZA2-6□□K | MHZA-A0608 | |
| | MHZA2-6□□M | MHZA-A0609 | |
| | MHZA2-6□□E | MHZA-A0610 | |

* End boss type

H = With hose nipple, K = With One-touch fitting, M = With M3 port, E = Side port

* The end boss assembly other than type E should be mounted on the special body.

Replacement part/Grease pack part no.: GR-S-010 (10 g)

- MHZ
- MHF
- MHL
- MHR
- MHK
- MHS
- MHC
- MHT
- MHY
- MHW
- X□
- MRHQ
- MA
- D-□

Dimensions: With Dust Cover

**MHZAJ2-6 □ Double acting/Single acting
Basic type**

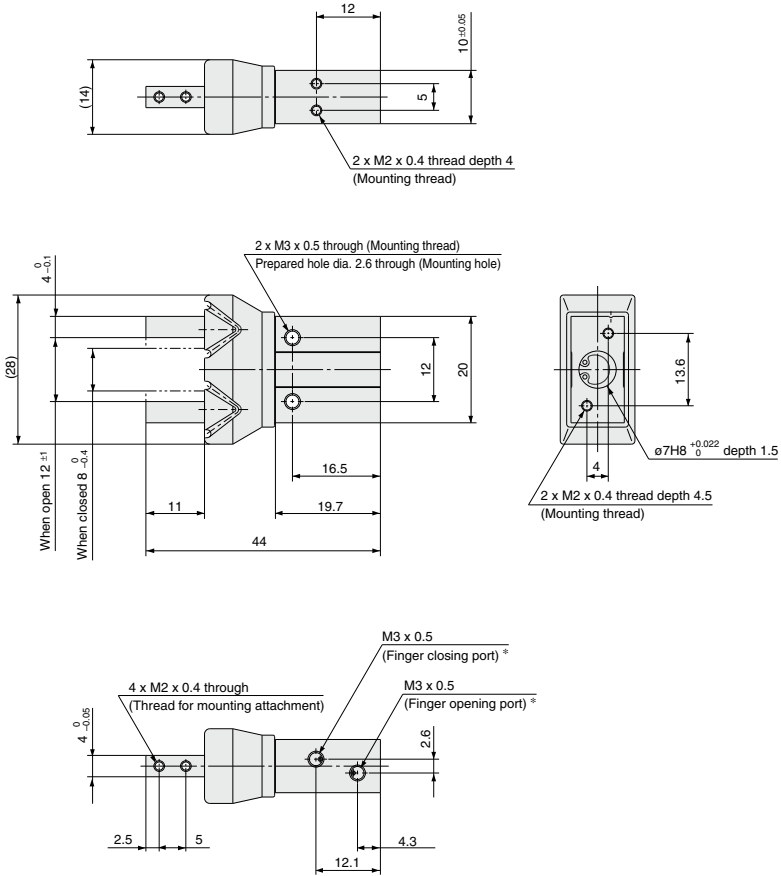

* For single action, the port on one side is a breathing hole.

| |
|-------------|
| MHZ |
| MHF |
| MHL |
| MHR |
| MHK |
| MHS |
| MHC |
| MHT |
| MHY |
| MHW |
| -X □ |
| MRHQ |
| MA |
| D- □ |

MHZA2-6 Series Finger Option

Side Tapped Mounting [1]

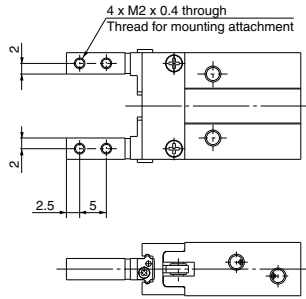

* Specifications and dimensions other than the above are the same as the basic type.

Through-holes in Opening/Closing Direction [2]

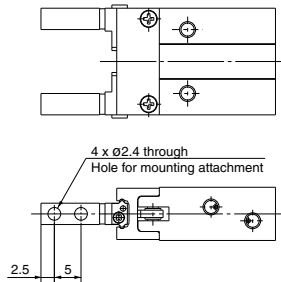

* Specifications and dimensions other than the above are the same as the basic type.

Flat Type Fingers [3]

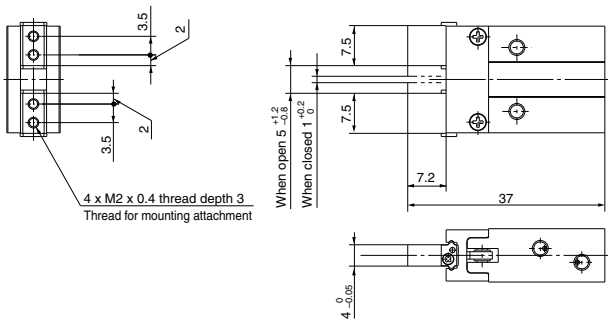

Weight: 25 g

Note) To mount attachments, use JISB1101 type M2 round head screws. Be careful not to use commercially available M2 hexagon socket head cap bolt as its top diameter is large.

* Specifications and dimensions other than the above are the same as the basic type.

MHZA2-6/MHZAJ2-6 Series

Body Option: End Boss Type

Applicable Model

| Symbol | Piping port location | Type of piping port | | Applicable model | |
|--------|----------------------|---------------------------|--------|------------------|---------------|
| | | MHZA2 | MHZAJ2 | Double acting | Single acting |
| E | Side ported | M3 x 0.5 | — | ● | ● |
| H | Axial ported | With ø4 hose nipple | | — | ● |
| K | | With ø4 One-touch fitting | | — | ● |
| M | | M3 x 0.5 | | — | ● |

Side Ported [E]

MHZA2-6□□E

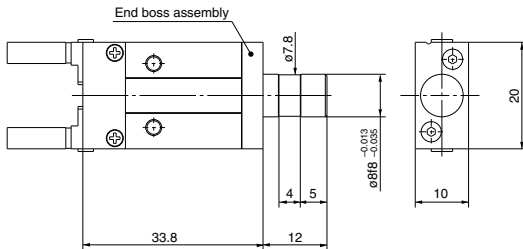

* Specifications and dimensions other than the above are the same as the basic type.

MHZAJ2-6□E□

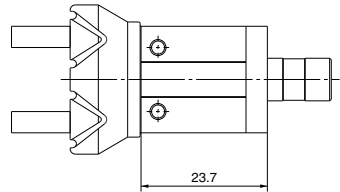

* Specifications and dimensions other than the above are the same as the basic type or the end boss dimensions of the MHZA type.

Axial Ported (with hose nipple) [H]

MHZA2-6^S□H

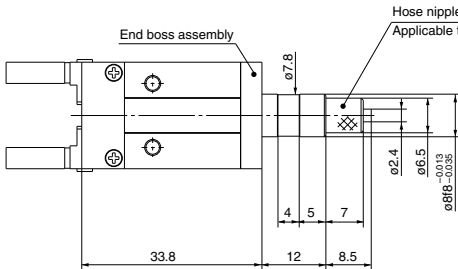

* Specifications and dimensions other than the above are the same as the basic type.

MHZAJ2-6^SH□

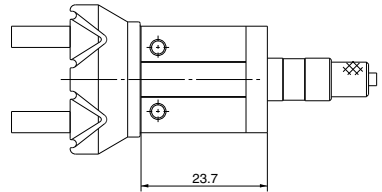

* Specifications and dimensions other than the above are the same as the basic type or the end boss dimensions of the MHZA type.

Applicable Tubing

| Specifications | Description/Model | Nylon tubing | Soft nylon tubing | Polyurethane tubing | Polyurethane coil tubing |
|-------------------------------|-------------------|--------------|-------------------|---------------------|--------------------------|
| | | T0425 | TS0425 | TU0425 | TCU0425B-1 |
| Outside diameter (mm) | | 4 | 4 | 4 | 4 |
| Max. operating pressure (MPa) | | 1.0 | 0.8 | 0.5 | 0.5 |
| Min. bending radius (mm) | | 13 | 12 | 10 | — |
| Operating temperature (°C) | | -20 to 60 | -20 to 60 | -20 to 60 | -20 to 60 |
| Material | | Nylon 12 | Nylon 12 | Polyurethane | Polyurethane |

Refer to "Pneumatic Piping Equipment (CAT. E50)" regarding One-touch fittings and tubing.

MHZ

MHF

MHL

MHR

MHK

MHS

MHC

MHT

MHY

MHW

-X□

MRHQ

MA

D-□

MHZA2-6/MHZAJ2-6 Series

Axial Ported (with One-touch fitting) [K]

MHZA2-6[□]K

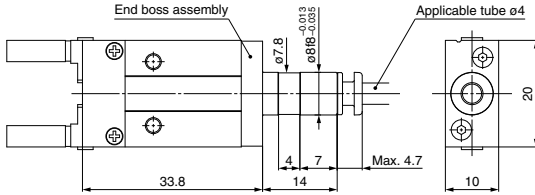

* Specifications and dimensions other than the above are the same as the basic type.

MHZAJ2-6[□]K

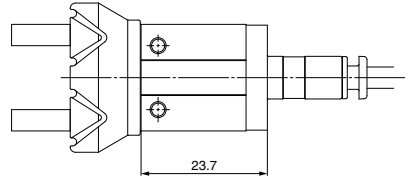

* Specifications and dimensions other than the above are the same as the basic type or the end boss dimensions of the MHZA type.

Applicable Tubing

| Description/Model | Nylon tubing | Soft nylon tubing | Polyurethane tubing | Polyurethane coil tubing |
|-------------------------------|--------------|-------------------|---------------------|--------------------------|
| Specifications | T0425 | TS0425 | TU0425 | TCU0425B-1 |
| Outside diameter (mm) | 4 | 4 | 4 | 4 |
| Max. operating pressure (MPa) | 1.0 | 0.8 | 0.5 | 0.5 |
| Min. bending radius (mm) | 13 | 12 | 10 | — |
| Operating temperature (°C) | -20 to 60 | -20 to 60 | -20 to 60 | -20 to 60 |
| Material | Nylon 12 | Nylon 12 | Polyurethane | Polyurethane |

Refer to "Pneumatic Piping Equipment (CAT. E50)" regarding One-touch fittings and tubing.

Axial Ported (with M3 port) [M]

MHZA2-6[□]M

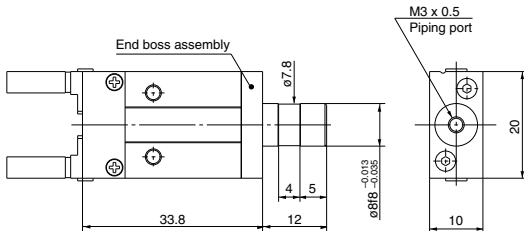

* Specifications and dimensions other than the above are the same as the basic type.

MHZAJ2-6[□]M

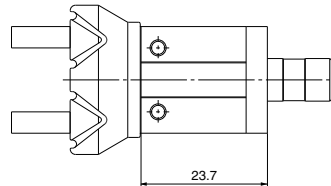

* Specifications and dimensions other than the above are the same as the basic type or the end boss dimensions of the MHZA type.

Weight

| Model | End boss type (Symbol) | | | |
|-----------------------|------------------------|----|----|----|
| | E | H | K | M |
| MHZA2-6 [□] | 28 | 28 | 28 | 28 |
| MHZAJ2-6 [□] | 29 | 29 | 29 | 29 |

(g)

Parallel Type Air Gripper/Standard Type

MHZ2 Series

ø6, ø10, ø16, ø20, ø25, ø32, ø40

How to Order

Bore size

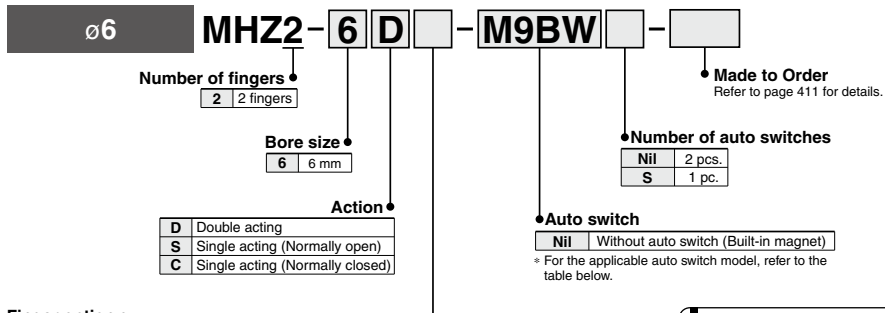

Finger option

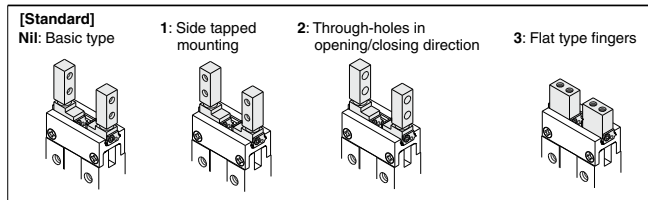

Moisture Control Tube IDK Series

When operating an actuator with a small diameter and a short stroke at a high frequency, the dew condensation (water droplet) may occur inside the piping depending on the conditions. Simply connecting the moisture control tube to the actuator will prevent dew condensation from occurring. For details, refer to [the IDK series in the Best Pneumatics No. 6](#).

Applicable Auto Switches

Refer to pages 797 to 850 for further information on the auto switch.

| Type | Special function | Electrical entry | Indicator light | Wiring (Output) | Load voltage | | Auto switch model | | Lead wire length (m) * | | | | Pre-wired connector | Applicable load | | | |
|-------------------------|-------------------------------|------------------|-----------------|-------------------------------------|--------------|-----------|----------------------------|----------------|------------------------|---------------|-------|-------|---------------------|-----------------|------------|---|------------|
| | | | | | DC | AC | Electrical entry direction | | 0.5 (Nil) | 1 (M) | 3 (L) | 5 (Z) | | | | | |
| | | | | | | | Perpendicular | In-line | | | | | | | | | |
| Solid state auto switch | — | Grommet | Yes | 3-wire (NPN) | 5 V, 12 V | — | M9NV | M9N | ● | ● | ● | ○ | ○ | IC circuit | Relay, PLC | | |
| | | | | 3-wire (PNP) | | | F8N | — | ● | — | ● | ○ | — | | | | |
| | | | | 2-wire | | | M9PV | M9P | ● | ● | ● | ○ | ○ | | | | |
| | | | | | | | F8P | — | ● | — | ● | ○ | — | | | | |
| | | | | 3-wire (NPN) | | | M9BV | M9B | ● | ● | ● | ○ | ○ | | | | |
| | | | | | | | F8B | — | ● | — | ● | ○ | — | | | | |
| | Diagnosis (2-color indicator) | | | Water resistant (2-color indicator) | 3-wire (NPN) | 5 V, 12 V | — | M9NWV | M9NW | ● | ● | ● | ○ | ○ | | ○ | IC circuit |
| | | | | | 3-wire (PNP) | | | M9PWV | M9PW | ● | ● | ● | ○ | ○ | | | |
| | | | | | 2-wire | | | M9BWW | M9BW | ● | ● | ● | ○ | ○ | | | |
| | | | | | | | | M9NAV** | M9NA** | ○ | ○ | ● | ○ | ○ | | | |
| | | | | | 3-wire (PNP) | | | M9PAV** | M9PA** | ○ | ○ | ○ | ○ | ○ | | | |
| | | | | | | | | 2-wire | M9BAV** | M9BA** | ○ | ○ | ● | ○ | | ○ | |

** Water resistant type auto switches can be mounted on the above models, but in such case SMC cannot guarantee water resistance.

* Lead wire length symbols: 0.5 m..... Nil (Example) M9NW

1 m..... M (Example) M9NWV

3 m..... L (Example) M9NWL

5 m..... Z (Example) M9NWZ

* Solid state auto switches marked with ○ are produced upon receipt of order.

Note 1) When using a D-F8□ switch, mount it at a distance of 10 mm or more from magnetic substances such as iron, etc.

Note 2) When using the 2-color indicator type, please make the setting so that the indicator is lit in red to ensure the detection at the proper position of the air gripper.

How to Order

Bore size

ø10 to ø25

MH2-16D **M9BW**

Number of fingers
2 2 fingers

| | |
|----|-------|
| 10 | 10 mm |
| 16 | 16 mm |
| 20 | 20 mm |
| 25 | 25 mm |

| Action | |
|--------|---------------------------------|
| D | Double acting |
| S | Single acting (Normally open) |
| C | Single acting (Normally closed) |

Auto switch

Nil | Without auto switch (Built-in magnet)

* For the applicable auto switch model, refer to the table below.

Made to Order
Refer to page 411 for details.

| Number of auto switches | |
|-------------------------|--------|
| Nil | 2 pcs. |
| S | 1 pc. |
| n | n pc. |

Finger position/option

Standard (MHQ2 compatible type)

Nil: Basic type



1: Side tapped mounting



2: Through-holes in opening/closing direction



3: Flat type fingers

The flat type fingers do not have standard and narrow options. When MHQ2/MHQ2 compatible types are required, see the -X51 made-to-order specifications on page 460.



Narrow type (MHQ2 compatible type)

N: Basic type



N1: Side tapped mounting



N2: Through-holes in opening/closing direction



Body option

Nil: Basic type

E: End boss type Side ported (Double acting/Single acting)

W: End boss type Axial ported ø4 One-touch fitting for coaxial tubing (Double acting)

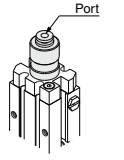
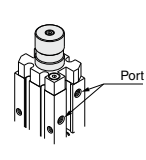
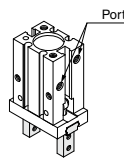

K: End boss type Axial ported with ø4 One-touch fitting (Single acting)

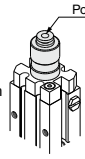

M: End boss type Axial ported with M5 port (Single acting)

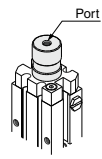

Applicable Auto Switches/Refer to pages 797 to 850 for further information on the auto switch.

| Type | Special function | Electrical entry | Indicator light | Wiring (Output) | Load voltage | | Auto switch model | | Lead wire length (m) * | | | | | Applicable model | Applicable load | | | |
|-------------------------|-------------------------------|------------------|-----------------|-----------------|--------------|-----|----------------------------|---------|------------------------|-------|-------|-------|-----|------------------|-----------------|-----|------------|------------|
| | | | | | DC | AC | Electrical entry direction | | 0.5 (Nil) | 1 (M) | 3 (L) | 5 (Z) | ø10 | | | ø16 | ø20 | ø25 |
| | | | | | | | Perpendicular | In-line | | | | | | | | | | |
| Solid state auto switch | — | Grommet | Yes | 3-wire (NPN) | 5 V, 12 V | — | M9NV | M9N | ● | ● | ● | ○ | ● | ● | ● | ○ | IC circuit | Relay, PLC |
| | | | | 3-wire (PNP) | | | F8N | — | — | — | — | — | — | — | — | — | | |
| | | | | 2-wire | M9PV | M9P | ● | ● | ● | ○ | ● | ● | ● | ○ | — | — | | |
| | | | | 3-wire (NPN) | F8P | — | — | — | — | — | — | — | — | — | — | — | | |
| | | | | 3-wire (PNP) | M9BV | M9B | ● | ● | ● | ○ | ● | ● | ● | ○ | — | — | | |
| | | | | 2-wire | F8B | — | — | — | — | — | — | — | — | — | — | — | | |
| | Diagnosis (2-color indicator) | Grommet | Yes | 3-wire (NPN) | 5 V, 12 V | — | M9NVV | M9NW | ● | ● | ● | ○ | ● | ● | ○ | — | IC circuit | Relay, PLC |
| | 3-wire (PNP) | | | M9PWW | | | M9PW | ● | ● | ● | ○ | ● | ● | ○ | — | | | |
| | 2-wire | | | M9BWW | M9BW | ● | ● | ● | ○ | ● | ● | ○ | — | — | | | | |
| | 3-wire (NPN) | | | M9NAV** | M9NA** | ○ | ○ | ○ | ○ | ○ | ○ | ○ | ○ | ○ | ○ | | | |
| | 3-wire (PNP) | | | M9PAV** | M9PA** | ○ | ○ | ○ | ○ | ○ | ○ | ○ | ○ | ○ | ○ | | | |
| | 2-wire | | | M9BAV** | M9BA** | ○ | ○ | ○ | ○ | ○ | ○ | ○ | ○ | ○ | ○ | | | |

** Water resistant type auto switches can be mounted on the above models, but in such case SMC cannot guarantee water resistance.

* Lead wire length symbols: 0.5 m..... Nil (Example) M9NW
1 m..... M (Example) M9NWM
3 m..... L (Example) M9NWL
5 m..... Z (Example) M9NWZ

* Solid state auto switches marked with ○ are produced upon receipt of order.

- Note 1) When using the 2-color indicator type, please make the setting so that the indicator is lit in red to ensure the detection at the proper position of the air gripper.
 Note 2) Through-hole mounting is not possible when using the auto switch at the square groove on the side.
 Note 3) When the product is ordered with auto switch, only MH22-10 is shipped with the auto switch mounting brackets. When the auto switch is used at the square groove on the side with MH22-16 to 25, mounting brackets (BMG2-012) are required. Please order them separately. Refer to page 457 for the auto switch mounting brackets.

Moisture Control Tube IDK Series



When operating an actuator with a small diameter and a short stroke at a high frequency, the dew condensation (water droplet) may occur inside the piping depending on the conditions.

Simply connecting the moisture control tube to the actuator will prevent dew condensation from occurring. For details, refer to [the IDK series in the Best Pneumatics No. 6](#).

MHZ2 Series

How to Order

Bore size

ø32 to ø40 **MHZ2-32 D** - **M9BW** - **□**

Number of fingers

| | |
|---|-----------|
| 2 | 2 fingers |
|---|-----------|

Bore size

| | |
|----|-------|
| 32 | 32 mm |
| 40 | 40 mm |

Action

| | |
|---|---------------------------------|
| D | Double acting |
| S | Single acting (Normally open) |
| C | Single acting (Normally closed) |

Number of auto switches

| | |
|-----|--------|
| Nil | 2 pcs. |
| S | 1 pc. |
| n | n pc. |

Auto switch

| | |
|-----|---------------------------------------|
| Nil | Without auto switch (Built-in magnet) |
|-----|---------------------------------------|

Made to Order
Refer to page 411 for details.

* For the applicable auto switch model, refer to the table below.

Finger option

[Standard] Nil: Basic type

1: Side tapped mounting

2: Through-holes in opening/closing direction

3: Flat type fingers

Applicable Auto Switches

Refer to pages 797 to 850 for further information on the auto switch.

| Type | Special function | Electrical entry | Indicator light | Wiring (Output) | Load voltage | | Auto switch model | | Lead wire length (m) * | | | | Pre-wired connector | Applicable load | |
|-------------------------|-------------------------------|------------------|-----------------|-----------------|--------------|---------|----------------------------|---------|------------------------|--------|-------|-------|---------------------|-----------------|------------|
| | | | | | DC | AC | Electrical entry direction | | 0.5 (Nil) | 1 (M) | 3 (L) | 5 (Z) | | | |
| | | | | | | | Perpendicular | In-line | | | | | | | |
| Solid state auto switch | — | Grommet | Yes | 3-wire (NPN) | 5 V, 12 V | — | M9NV | M9N | ● | ● | ● | ○ | ○ | IC circuit | Relay, PLC |
| | | | | 3-wire (PNP) | | | F8N | — | ● | — | ● | ○ | — | | |
| | | | | 2-wire | 12 V | M9PV | M9P | ● | ● | ● | ○ | ○ | | | |
| | | | | | | F8P | — | ● | — | ● | ○ | — | | | |
| | | | | 3-wire (NPN) | 5 V, 12 V | — | M9BV | M9B | ● | ● | ● | ○ | ○ | | |
| | | | | | | | F8B | — | ● | — | ● | ○ | — | | |
| | Diagnosis (2-color indicator) | Grommet | Yes | 3-wire (NPN) | 5 V, 12 V | — | M9NVV | M9NW | ● | ● | ● | ○ | ○ | IC circuit | |
| | | | | 3-wire (PNP) | | | M9PWW | M9PW | ● | ● | ● | ○ | ○ | | |
| | | | | 2-wire | 12 V | M9BVV | M9BW | ● | ● | ● | ○ | ○ | | | |
| | | | | | | M9NAV** | M9NA** | ○ | ○ | ● | ○ | ○ | IC circuit | | |
| | | | | 3-wire (PNP) | 5 V, 12 V | — | M9PAV** | M9PA** | ○ | ○ | ● | ○ | ○ | IC circuit | |
| | | | | | | | 2-wire | 12 V | M9BAV** | M9BA** | ○ | ○ | ● | ○ | |

** Water resistant type auto switches can be mounted on the above models, but in such case SMC cannot guarantee water resistance.

* Lead wire length symbols: 0.5 m..... Nil (Example) M9NW

* Solid state auto switches marked with ○ are produced upon receipt of order.

1 m..... M (Example) M9NWM

3 m..... L (Example) M9NWL

5 m..... Z (Example) M9NWZ

Note 1) When using the 2-color indicator type, please make the setting so that the indicator is lit in red to ensure the detection at the proper position of the air gripper.

Note 2) Through-hole mounting is not possible when using the auto switch at the square groove on the side.

Note 3) When the auto switch is used at the square groove on the side with MHZ2-32 and 40, mounting brackets (BMG2-012) are required. Please order them separately. Refer to page 457 for the auto switch mounting brackets.

ø6



ø10 to ø25

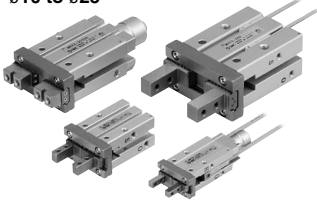

ø32, ø40



Symbol

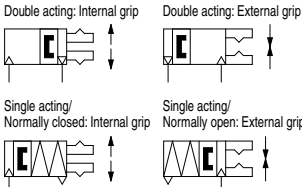

Refer to pages 454 to 458 for the specifications with auto switch.

- Auto switch installation examples and mounting positions
- Auto switch hysteresis
- Auto switch mounting
- Protrusion of auto switch from edge of body



Made to Order: Individual Specifications
(For details, refer to pages 459 and 460.)

| Symbol | Specifications/Description |
|--------|--|
| -X46 | Built-in needle valve for finger speed control |
| -X51 | MHQ2/MHQG2-compliant flat type fingers |



Made to Order
[Click here for details](#)

| Symbol | Specifications/Description |
|--------|--|
| -X4 | Heat resistance (100°C) |
| -X5 | Fluororubber seal |
| -X7 | Closing direction spring assist |
| -X12 | Opening direction spring assist |
| -X50 | Without magnet |
| -X53 | EPDM seal/Fluorine grease |
| -X56 | Axial ported type |
| -X63 | Fluorine grease |
| -X79 | Grease for food processing machines, Fluorine grease |
| -X79A | Grease for food processing machines |
| -X81A | Anti-corrosive treatment of finger |
| -X81B | Anti-corrosive treatment of finger and guide |

Specifications

| | | Fluid | Air |
|---------------------------------------|---------------|--|---|
| Operating pressure | Double acting | ø6: 0.15 to 0.7 MPa ø10: 0.2 to 0.7 MPa ø16 to ø40: 0.1 to 0.7 MPa | |
| | Single acting | Normally open | ø6: 0.3 to 0.7 MPa ø10: 0.35 to 0.7 MPa ø16 to ø40: 0.25 to 0.7 MPa |
| | | Normally closed | — |
| Ambient and fluid temperature | | -10 to 60°C | |
| Repeatability | | ø6 to ø25: ±0.01 mm ø32, ø40: ±0.02 mm | |
| Max. operating frequency | | ø6 to ø25: 180 c.p.m. ø32, ø40: 60 c.p.m. | |
| Lubrication | | Not required | |
| Action | | Double acting/Single acting | |
| Auto switch (Option) ^{Note)} | | Solid state auto switch (3-wire, 2-wire) | |

Note) Refer to pages 797 to 850 for further information on auto switches.
* Use the gripper with dust cover when used in a place where there may be dust.

Model

| Action | Model | Bore size (mm) | Gripping force ^{Note 1)} | | Opening/ Closing stroke (Both sides) (mm) | Weight (g) ^{Note 2)} | |
|---------------|-----------------|----------------|---|----------|---|-------------------------------|------|
| | | | Gripping force per finger Effective value (N) | | | | |
| | | | External | Internal | | | |
| Double acting | MHZ2-6D | 6 | 3.3 | 6.1 | 4 | 27 | |
| | MHZ2-10D(N) | 10 | 11 | 17 | 4 | 55 | |
| | MHZ2-16D(N) | 16 | 34 | 45 | 6 | 115 | |
| | MHZ2-20D(N) | 20 | 42 | 66 | 10 | 230 | |
| | MHZ2-25D(N) | 25 | 65 | 104 | 14 | 420 | |
| | MHZ2-32D | 32 | 158 | 193 | 22 | 715 | |
| Single acting | MHZ2-40D | 40 | 254 | 318 | 30 | 1275 | |
| | Normally open | MHZ2-6S | 6 | 1.9 | — | 4 | 27 |
| | | MHZ2-10S(N) | 10 | 7.1 | — | 4 | 55 |
| | | MHZ2-16S(N) | 16 | 27 | — | 6 | 115 |
| | | MHZ2-20S(N) | 20 | 33 | — | 10 | 235 |
| | | MHZ2-25S(N) | 25 | 45 | — | 14 | 425 |
| | | MHZ2-32S | 32 | 131 | — | 22 | 760 |
| | Normally closed | MHZ2-40S | 40 | 217 | — | 30 | 1370 |
| | | MHZ2-6C | 6 | — | 3.7 | 4 | 27 |
| | | MHZ2-10C(N) | 10 | — | 13 | 4 | 55 |
| | | MHZ2-16C(N) | 16 | — | 38 | 6 | 115 |
| | | MHZ2-20C(N) | 20 | — | 57 | 10 | 235 |
| | | MHZ2-25C(N) | 25 | — | 83 | 14 | 425 |
| | | MHZ2-32C | 32 | — | 161 | 22 | 760 |
| MHZ2-40C | | 40 | — | 267 | 30 | 1370 | |

Note 1) Values based on pressure of 0.5 MPa, gripping point L = 20 mm, at center of stroke.
Note 2) Values excluding weight of auto switch.

Option

● Body Option/End Boss Type

| Symbol | Piping port location | Type of piping port | | | | | | Applicable model | | |
|----------|----------------------|---------------------|--|----------|---------|---------|---------|------------------|---------------|---------------|
| | | MHZ2-6 | MHZ2-10 | MHZ2-16 | MHZ2-20 | MHZ2-25 | MHZ2-32 | MHZ2-40 | Double acting | Single acting |
| N | Basic type | M3 x 0.5 | M5 x 0.8 | | | | | ● | ● | |
| E | Side ported | — | M3 x 0.5 | M5 x 0.8 | | | | | ● | ● |
| W | Axial ported | — | With ø4 One-touch fitting for coaxial tubing | | | — | — | ● | — | |
| K | Axial ported | — | With ø4 One-touch fitting | | | — | — | — | ● | |
| M | Axial ported | — | M5 x 0.8 | | | | | — | ● | |

* For detailed body option specifications, refer to option specifications on pages 424 and 425.

MHZ

MHF

MHL

MHR

MHK

MHS

MHC

MHT

MHY

MHW

-X□

MRHQ

MA

D-□

MHZ2 Series

Clean Series: Air Gripper

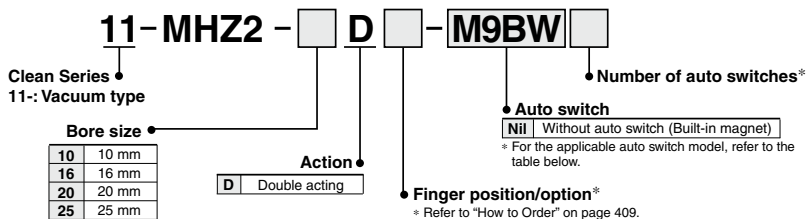

Applicable Auto Switches

Refer to pages 797 to 850 for further information on the auto switch.

| Type | Special function | Electrical entry | Indicator light | Wiring (Output) | Load voltage | | Auto switch model | | Lead wire length (m) * | | | | Pre-wired connector | Applicable load | |
|-------------------------|-------------------------------|------------------|-----------------|-----------------|--------------|-----------|----------------------------|---------|------------------------|-------|-------|-------|---------------------|-----------------|------------|
| | | | | | DC | AC | Electrical entry direction | In-line | 0.5 (Nil) | 1 (M) | 3 (L) | 5 (Z) | | | |
| Solid state auto switch | — | Grommet | Yes | 3-wire (NPN) | 24 V | 5 V, 12 V | M9NV | M9N | ● | ● | ● | ○ | ○ | IC circuit | Relay, PLC |
| | | | | 3-wire (PNP) | | | F8N | — | ● | ● | ● | ○ | — | | |
| | | | | 2-wire | | | M9PV | M9P | ● | ● | ● | ○ | ○ | | |
| | | | | 3-wire (NPN) | | | F8P | — | ● | ● | ● | ○ | — | | |
| | | | | 3-wire (PNP) | | | M9BV | M9B | ● | ● | ● | ○ | ○ | | |
| | | | | 2-wire | | | F8B | — | ● | ● | ● | ○ | — | | |
| | Diagnosis (2-color indicator) | Grommet | Yes | 3-wire (NPN) | 24 V | 5 V, 12 V | M9NWV | M9NW | ● | ● | ● | ○ | ○ | IC circuit | Relay, PLC |
| | 3-wire (PNP) | | | M9PWV | | | M9PW | ● | ● | ● | ○ | ○ | | | |
| | 2-wire | | | M9BWW | | | M9BW | ● | ● | ● | ○ | ○ | | | |
| | 3-wire (NPN) | | | M9NAV** | | | M9NA** | ○ | ○ | ● | ○ | ○ | | | |
| | 3-wire (PNP) | | | M9PAV** | | | M9PA** | ○ | ○ | ● | ○ | ○ | | | |
| | 2-wire | | | M9BAV** | | | M9BA** | ○ | ○ | ● | ○ | ○ | | | |

* Water resistant type auto switches can be mounted on the above models, but in such case SMC cannot guarantee water resistance.

* Lead wire length symbols: 0.5 m..... Nil (Example) M9NW

* Solid state auto switches marked with ○ are produced upon receipt of order.

1 m..... M (Example) M9NWM

3 m..... L (Example) M9NWL

5 m..... Z (Example) M9NWZ

Note 1) When using the 2-color indicator type, please make the setting so that the indicator is lit in red to ensure the detection at the proper position of the air gripper.

Note 2) When using a D-F8□ switch, mount it at a distance of 10 mm or more from magnetic substances such as iron, etc.

Note 3) For 11-MHZ2-10D□, the through-hole mounting cannot be made when using the auto switch.

Note 4) Two extension fitting assemblies (P331176A) are supplied with 11-MHZ2-10D□. Please use them if the fitting interferes with the auto switch.

Specifications

| | |
|--------------------------------------|---|
| Fluid | Air |
| Operating pressure | ø10: 0.2 to 0.7 MPa ø16 to ø25: 0.1 to 0.7 MPa |
| Ambient and fluid temperature | -10 to 60°C |
| Repeatability | ±0.01 mm |
| Max. operating frequency | 180 c.p.m. |
| Lubrication | Not required |
| Action | Double acting |
| Cleanliness class (ISO class) | Class 4 |
| Auto switch (Option) | Solid state auto switch (3-wire, 2-wire) |

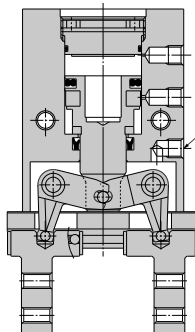
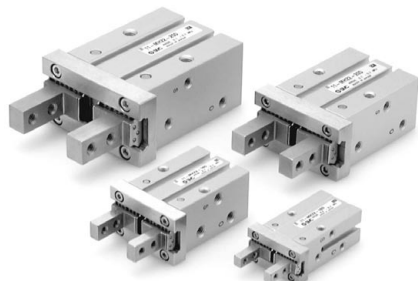

Vacuum port

The concentrated vacuuming of internally generated particulates prevents them from spreading into the clean room.

Construction: MHZ2-6□

Double acting/With fingers open

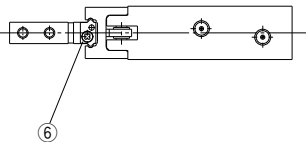
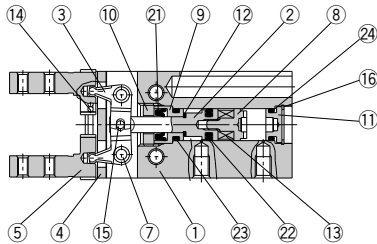

Double acting/With fingers closed

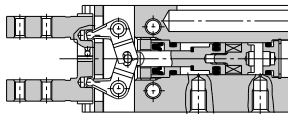

Single acting/Normally open

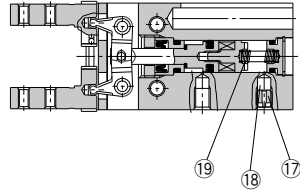

Single acting/Normally closed

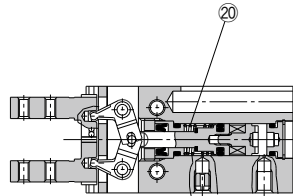

Component Parts

| No. | Description | Material | Note |
|-----|----------------|-----------------|---------------------------|
| 1 | Body | Aluminum alloy | Hard anodized |
| 2 | Piston | Stainless steel | |
| 3 | Lever | Stainless steel | Heat treated |
| 4 | Guide | Stainless steel | Heat treated |
| 5 | Finger | Stainless steel | Heat treated |
| 6 | Roller stopper | Stainless steel | |
| 7 | Lever shaft | Stainless steel | Nitriding |
| 8 | Magnet holder | Stainless steel | |
| 9 | Holder | Brass | Electroless nicked plated |
| 10 | Holder lock | Stainless steel | |
| 11 | Cap | Aluminum alloy | Clear anodized |
| 12 | Bumper | Urethane rubber | |
| 13 | Magnet | — | Nickel plated |

Component Parts

| No. | Description | Material | Note |
|-----|-----------------------|----------------------------------|---------------------------|
| 14 | Steel balls | High carbon chrome bearing steel | |
| 15 | Needle roller | High carbon chrome bearing steel | |
| 16 | Type C retaining ring | Carbon steel | Phosphate coated |
| 17 | Exhaust plug | Brass | Electroless nickel plated |
| 18 | Exhaust filter | Polyvinyl formal | |
| 19 | N.O. spring | Stainless steel spring wire | |
| 20 | N.C. spring | Stainless steel spring wire | |
| 21 | Rod seal | NBR | |
| 22 | Piston seal | NBR | |
| 23 | Gasket | NBR | |
| 24 | Gasket | NBR | |

Replacement Parts

| Description | | MHZ2-6 | Main parts |
|-----------------|----------|---|----------------|
| Finger assembly | | Please contact SMC to replace the seal kit and finger assembly. | |
| Piston assembly | MHZ2-6D□ | MHZ-A0603 | ②⑧⑨⑩⑫⑬⑮⑰⑱⑲⑳㉑㉒㉓ |
| | MHZ2-6S□ | | |
| | MHZ2-6C□ | | |

Replacement part/Grease pack part no.: GR-S-010 (10 g)

MHZ

MHF

MHL

MHR

MHK

MHS

MHC

MHT

MHY

MHW

-X□

MRHQ

MA

D-□

MHZ2 Series

Construction: MHZ2-10□ to 25□

Double acting/With fingers open

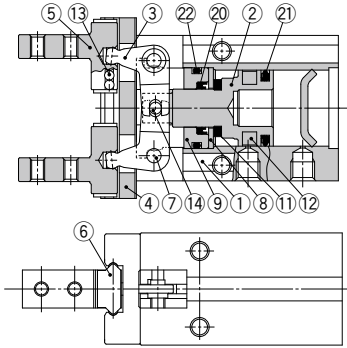

Double acting/With fingers closed

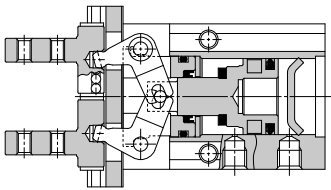

Single acting/Normally open

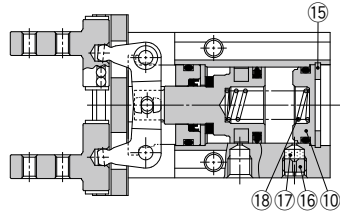

Single acting/Normally closed

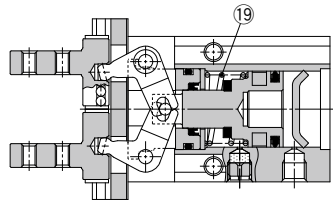

Component Parts

| No. | Description | Material | Note |
|-----|----------------|---|----------------------------------|
| 1 | Body | Aluminum alloy | Hard anodized |
| 2 | Piston | ø10, ø16: Stainless steel ø20, ø25: Aluminum alloy | ø20, ø25: Hard anodized |
| 3 | Lever | Stainless steel | Nitriding |
| 4 | Guide | Stainless steel | Heat treated |
| 5 | Finger | Stainless steel | Heat treated |
| 6 | Roller stopper | Stainless steel | |
| 7 | Lever shaft | Stainless steel | Nitriding |
| 8 | Seal support | Stainless steel | |
| 9 | Rod cover | Synthetic resin | |
| 10 | Cap | Synthetic resin | Single acting/Normally open only |
| 11 | Bumper | Urethane rubber | |

Component Parts

| No. | Description | Material | Note |
|-----|-----------------------|----------------------------------|--|
| 12 | Rubber magnet | Synthetic rubber | |
| 13 | Steel balls | High carbon chrome bearing steel | |
| 14 | Needle roller | High carbon chrome bearing steel | |
| 15 | Type C retaining ring | Carbon steel | Phosphate coated Single acting/Normally open only |
| 16 | Exhaust plug A | Brass | Electroless nickel plated |
| 17 | Exhaust filter A | Polyvinyl formal | |
| 18 | N.O. spring | Stainless steel spring wire | |
| 19 | N.C. spring | Stainless steel spring wire | |
| 20 | Rod seal | NBR | |
| 21 | Piston seal | NBR | |
| 22 | Gasket | NBR | |

Replacement Parts

| Description | MHZ2-10 | MHZ2-16 | MHZ2-20 | MHZ2-25 | Main parts | |
|-------------------|--------------|-----------------|-----------------|-----------------|-----------------|--|
| Seal kit | MHZ2-□□□□ | MHZ10-PS | MHZ16-PS | MHZ20-PS | MHZ25-PS | ⑳㉑㉒ |
| | MHZ2-□□□□ | MHZ10S-PS | MHZ16S-PS | MHZ20S-PS | MHZ25S-PS | |
| Finger assembly | MHZ2-□□□(N) | MHZ-AA1002(N) | MHZ-AA1602(N) | MHZ-AA2002(N) | MHZ-AA2502(N) | ④⑤⑥⑬ |
| | MHZ2-□□□(N)1 | MHZ-AA1002(N)-1 | MHZ-AA1602(N)-1 | MHZ-AA2002(N)-1 | MHZ-AA2502(N)-1 | |
| | MHZ2-□□□(N)2 | MHZ-AA1002(N)-2 | MHZ-AA1602(N)-2 | MHZ-AA2002(N)-2 | MHZ-AA2502(N)-2 | |
| Piston assembly | MHZ2-□□□3 | MHZ-AA1002-3 | MHZ-AA1602-3 | MHZ-AA2002-3 | MHZ-AA2502-3 | ②①⑫⑭ |
| | MHZ2-□□□□ | MHZ-AA1003 | MHZ-AA1603 | MHZ-AA2003 | MHZ-AA2503 | |
| | MHZ2-□□□□ | | | | | |
| End boss assembly | MHZ2-□□□□W | MHZ-A1007 | MHZ-A1607 | MHZ-A2007 | MHZ-A2507 | Main body of adaptor Mounting screw for adaptor Seal |
| | MHZ2-□□□□K | MHZ-A1008 | MHZ-A1608 | MHZ-A2008 | MHZ-A2508 | |
| | MHZ2-□□□□M | MHZ-A1009 | MHZ-A1609 | MHZ-A2009 | MHZ-A2509 | |
| | MHZ2-□□□□E | MHZ-A1010 | MHZ-A1610 | MHZ-A2010 | MHZ-A2510 | |
| Lever assembly | MHZ-AA1004 | MHZ-AA1604 | MHZ-AA2004 | MHZ-AA2504 | ③ | |

* Finger option

1 = Side tapped, 2 = Through-hole, 3 = Flat type fingers

* End boss type

W = One-touch-fitting for coaxial tubing, K = With One-touch fitting, M = With M5 port, E = Side ported

* The end boss assembly other than type E should be mounted on the special body.

Replacement part/Grease pack part no.: GR-S-010 (10 g)

Construction: MHZ2-32□ to 40□

Double acting/With fingers open

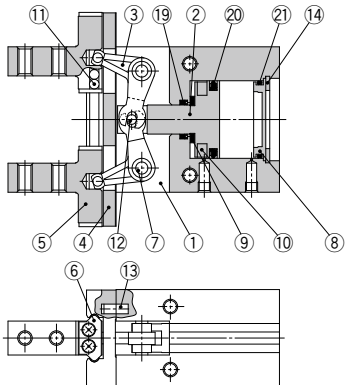

Single acting/Normally open

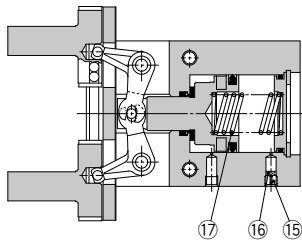

Single acting/Normally closed

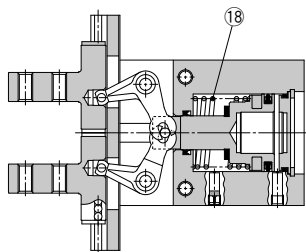

Double acting/With fingers closed

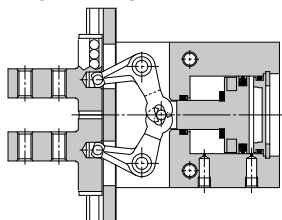

Component Parts

| No. | Description | Material | Note |
|-----|----------------|----------------------------------|----------------|
| 1 | Body | Aluminum alloy | Hard anodized |
| 2 | Piston | Aluminum alloy | Hard anodized |
| 3 | Lever | Stainless steel | Heat treated |
| 4 | Guide | Stainless steel | Heat treated |
| 5 | Finger | Stainless steel | Heat treated |
| 6 | Roller stopper | Stainless steel | |
| 7 | Lever shaft | Stainless steel | Nitriding |
| 8 | Cap | Aluminum alloy | Clear anodized |
| 9 | Bumper | Urethane rubber | |
| 10 | Rubber magnet | Synthetic rubber | |
| 11 | Steel balls | High carbon chrome bearing steel | |

Component Parts

| No. | Description | Material | Note |
|-----|-----------------------|----------------------------------|---------------------------|
| 12 | Needle roller | High carbon chrome bearing steel | |
| 13 | Parallel pin | Stainless steel | |
| 14 | Type C retaining ring | Carbon steel | Phosphate coated |
| 15 | Exhaust plug A | Brass | Electroless nickel plated |
| 16 | Exhaust filter A | Polyvinyl formal | |
| 17 | N.O. spring | Stainless steel spring wire | |
| 18 | N.C. spring | Stainless steel spring wire | |
| 19 | Rod seal | NBR | |
| 20 | Piston seal | NBR | |
| 21 | Gasket | NBR | |

Replacement Parts

| Description | | MHZ2-32 | MHZ2-40 | Main parts |
|-----------------|--------------|-------------|-------------|-------------------------------------|
| Seal kit | | MHZ32-PS | MHZ40-PS | (19)(20)(21) |
| Finger assembly | MHZ2-□□□(N) | MHZ-A3202 | MHZ-A4002 | (4)(5)(6)(11)(13) Mounting screw |
| | MHZ2-□□□(N)1 | MHZ-A3202-1 | MHZ-A4002-1 | |
| | MHZ2-□□□(N)2 | MHZ-A3202-2 | MHZ-A4002-2 | |
| Piston assembly | MHZ2-□□□3 | MHZ-A3202-3 | MHZ-A4002-3 | (2)(9)(10)(12) |
| | MHZ2-□□□□ | MHZ-A3203 | MHZ-A4003 | |
| | MHZ2-□□□□ | MHZ-A3203S | MHZ-A4003S | |
| Lever assembly | | MHZ-A3204 | MHZ-A4004 | (3) |

* Finger option

1 = Side tapped, 2 = Through-hole, 3 = Flat type fingers

Replacement part/Grease pack part no.: GR-S-010 (10 g)

MHZ

MHF

MHL

MHR

MHK

MHS

MHC

MHT

MHY

MHW

-X□

MRHQ

MA

D-□

MHZ2 Series

Dimensions

MHZ2-6□ Double acting/Single acting Basic type

Use the MHZJ2 series with a dust cover when used in a place where there may be dust.

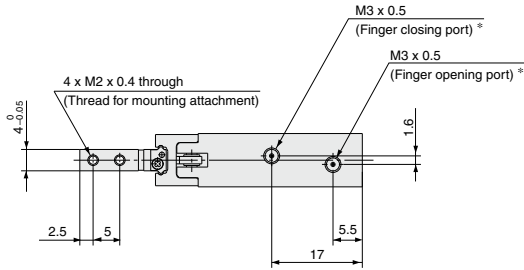
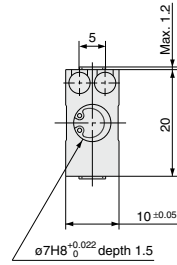
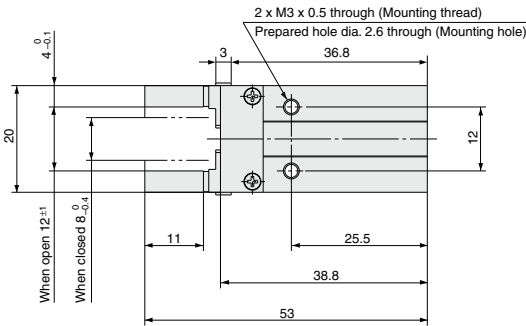
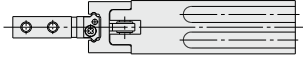

* For single action, the port on one side is a breathing hole.

Auto Switch Mounting Groove Dimensions

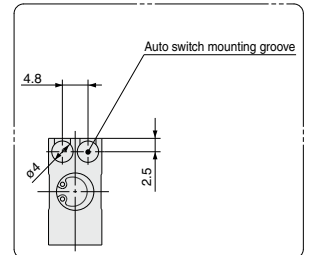

MHZ2-10 □ Double acting/Single acting Basic type

Use the MHZJ2 series with a dust cover when used in a place where there may be dust.

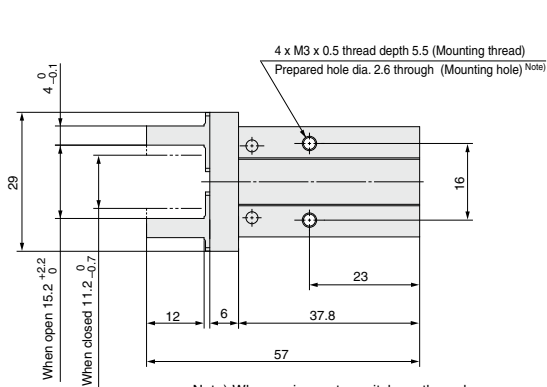
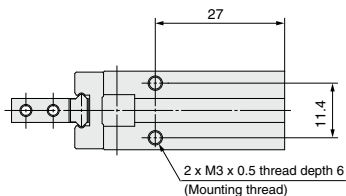

Note) When using auto switches, through-hole mounting is not possible.

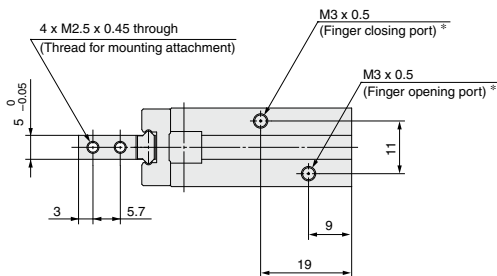
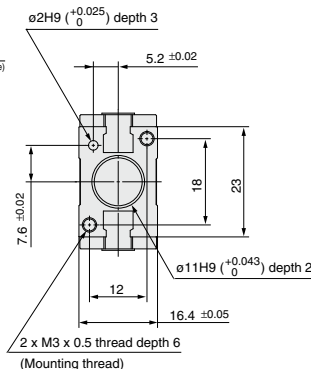

* For single action, the port on one side is a breathing hole.

Finger Position/Narrow Type

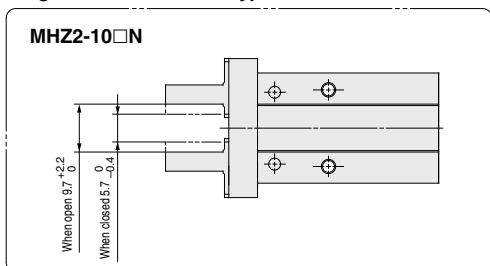

Auto Switch Mounting Groove Dimensions

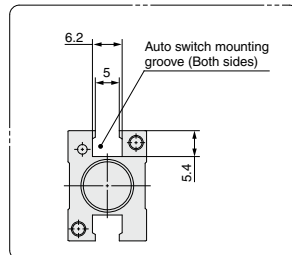

Note) When using auto switches, through-hole mounting is not possible.

- MHZ
- MHF
- MHL
- MHR
- MHK
- MHS
- MHC
- MHT
- MHY
- MHW
- X □
- MRHQ
- MA
- D- □

MHZ2 Series

Dimensions

MHZ2-16□ Double acting/Single acting Basic type

Use the MHZJ2 series with a dust cover when used in a place where there may be dust.

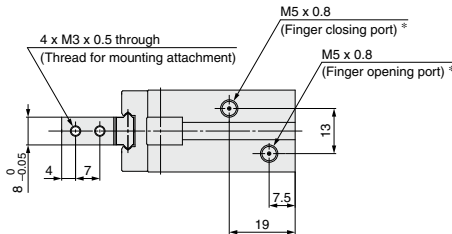
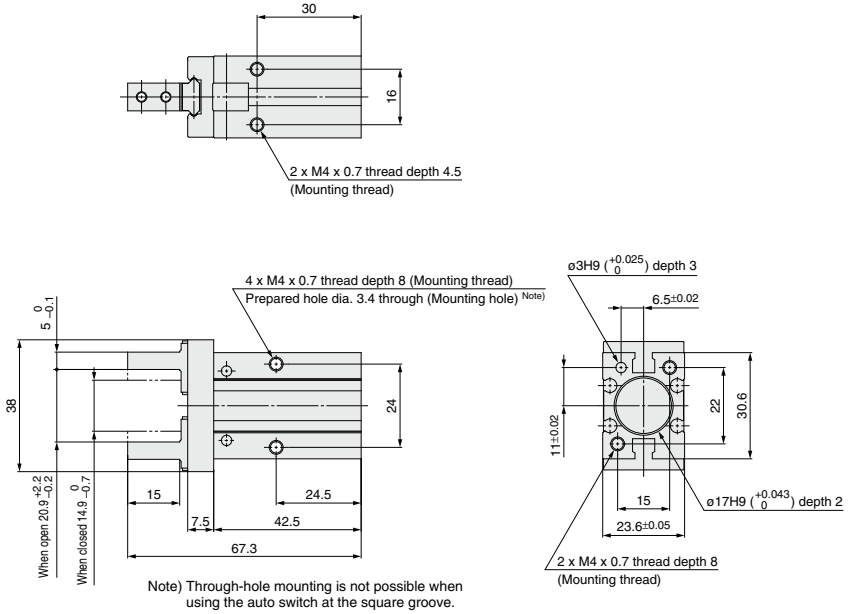

* For single action, the port on one side is a breathing hole.

Finger Position/Narrow Type

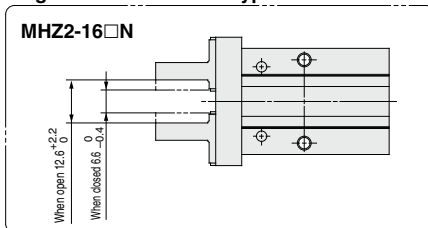

Auto Switch Mounting Groove Dimensions

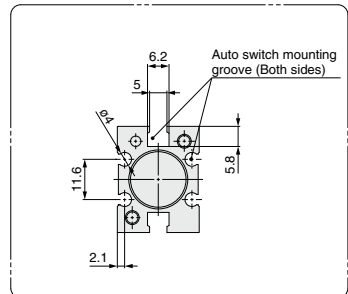

Note) Through-hole mounting is not possible when using the auto switch at the square groove.

MHZ2-20□ Double acting/Single acting Basic type

Use the MHZJ2 series with a dust cover when used in a place where there may be dust.

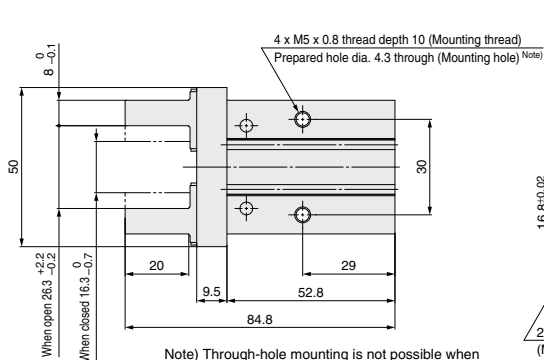
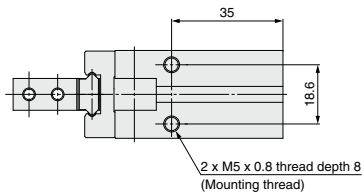

Note) Through-hole mounting is not possible when using the auto switch at the square groove.

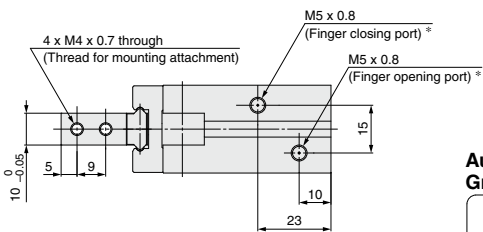
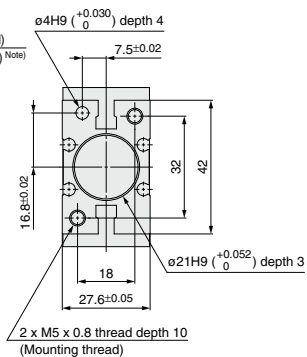

* For single action, the port on one side is a breathing hole.

Finger Position/Narrow Type

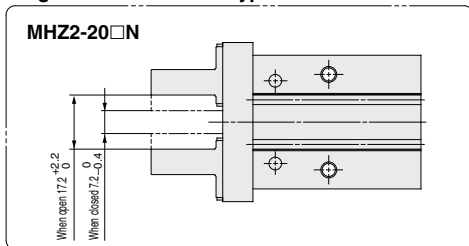

Auto Switch Mounting Groove Dimensions

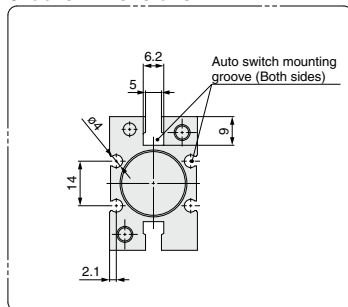

Note) Through-hole mounting is not possible when using the auto switch at the square groove.

MHZ

MHF

MHL

MHR

MHK

MHS

MHC

MHT

MHY

MHW

-X□

MRHQ

MA

D-□

MHZ2 Series

Dimensions

MHZ2-25 □ Double acting/Single acting Basic type

Use the MHZJ2 series with a dust cover when used in a place where there may be dust.

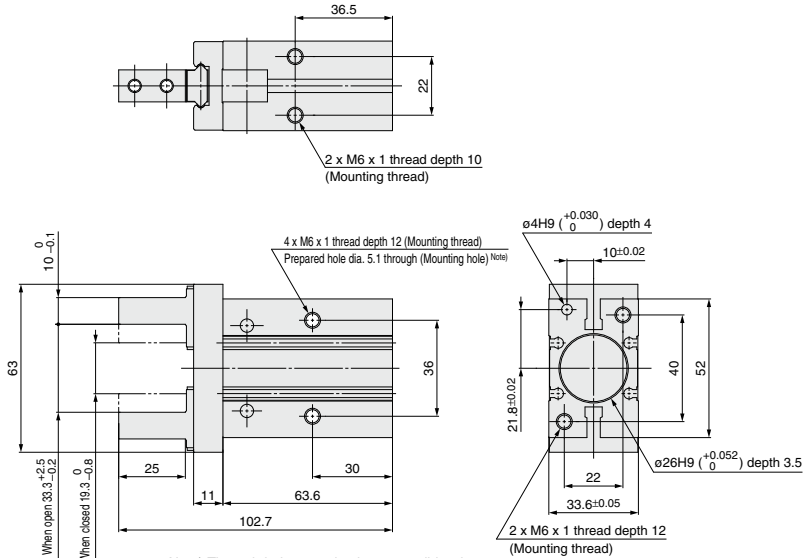

Note) Through-hole mounting is not possible when using the auto switch at the square groove.

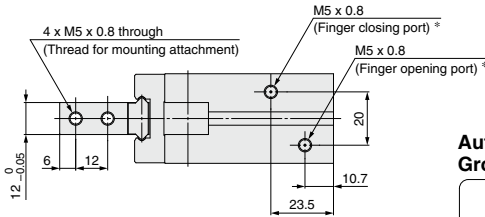

* For single action, the port on one side is a breathing hole.

Finger Position/Narrow Type

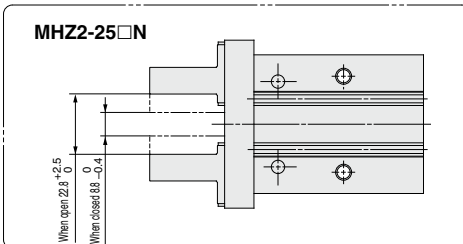

Auto Switch Mounting Groove Dimensions

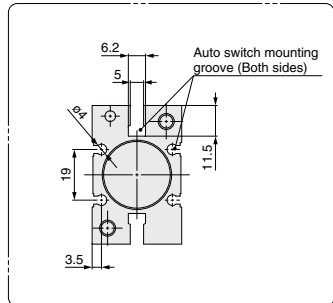

Note) Through-hole mounting is not possible when using the auto switch at the square groove.

MHZ2-32 □ Double acting/Single acting Basic type

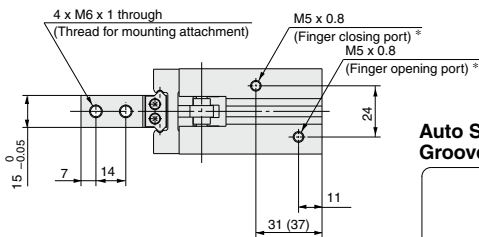
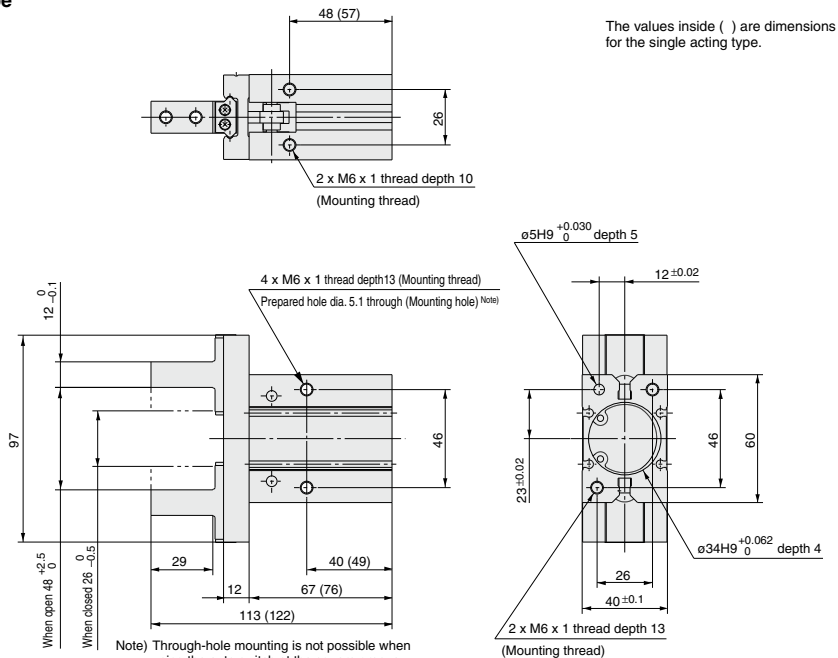

* For single action, the port on one side is a breathing hole.

Auto Switch Mounting Groove Dimensions

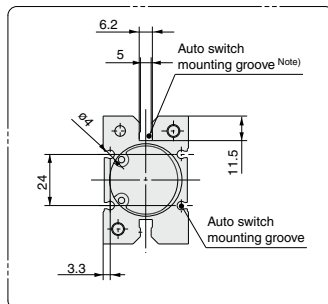

Note) Through-hole mounting is not possible when using the auto switch at the square groove.

MHZ

MHF

MHL

MHR

MHK

MHS

MHC

MHT

MHY

MHW

-X □

MRHQ

MA

D □

MHZ2 Series

Dimensions

MHZ2-40 □ Double acting/Single acting Basic type

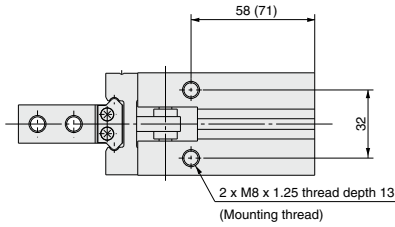

The values inside () are dimensions for the single acting type.

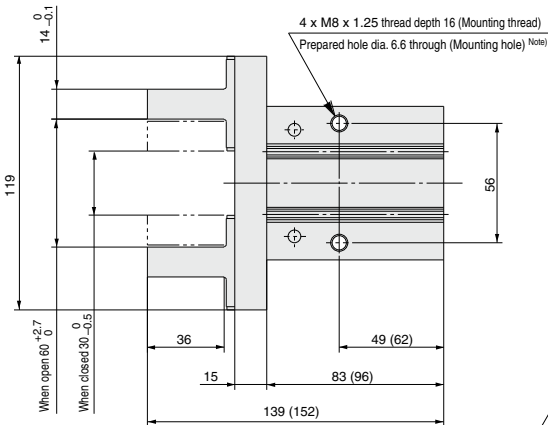

Note) Through-hole mounting is not possible when using the auto switch at the square groove.

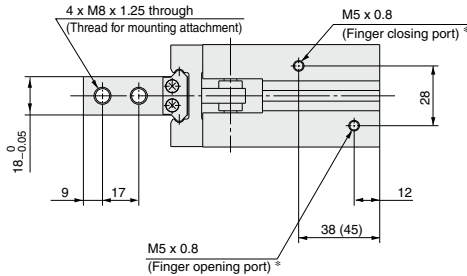
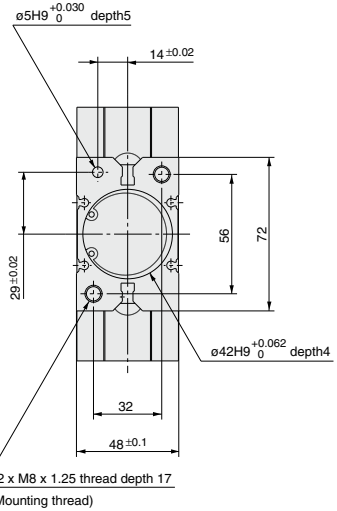

* For single action, the port on one side is a breathing hole.

Auto Switch Mounting Groove Dimensions

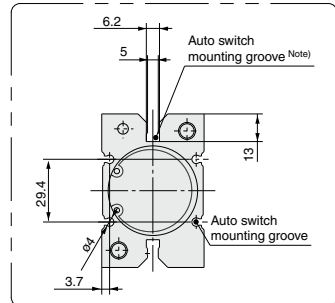

Note) Through-hole mounting is not possible when using the auto switch at the square groove.

Standard Type/MHZ2 Series Finger Option

Side Tapped Mounting [1/N1]

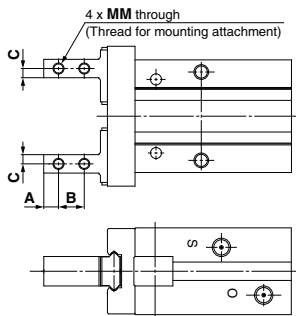

(mm)

| Model | A | B | C | MM |
|--------------------------|-----|-----|-----|-------------|
| MHZ2-6□1 | 2.5 | 5 | 2 | M2 x 0.4 |
| MHZ2-10□ _{N1} 1 | 3 | 5.7 | 2 | M2.5 x 0.45 |
| MHZ2-16□ _{N1} 1 | 4 | 7 | 2.5 | M3 x 0.5 |
| MHZ2-20□ _{N1} 1 | 5 | 9 | 4 | M4 x 0.7 |
| MHZ2-25□ _{N1} 1 | 6 | 12 | 5 | M5 x 0.8 |
| MHZ2-32□1 | 7 | 14 | 6 | M6 x 1 |
| MHZ2-40□1 | 9 | 17 | 7 | M8 x 1.25 |

* Specifications and dimensions other than the above are the same as the basic type (including narrow type).

Through-holes in Opening/ Closing Direction [2/N2]

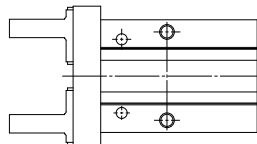

4 x øH through
(Hole for mounting attachment)

(mm)

| Model | A | B | H |
|--------------------------|-----|-----|-----|
| MHZ2-6□2 | 2.5 | 5 | 2.4 |
| MHZ2-10□ _{N2} 2 | 3 | 5.7 | 2.9 |
| MHZ2-16□ _{N2} 2 | 4 | 7 | 3.4 |
| MHZ2-20□ _{N2} 2 | 5 | 9 | 4.5 |
| MHZ2-25□ _{N2} 2 | 6 | 12 | 5.5 |
| MHZ2-32□2 | 7 | 14 | 6.6 |
| MHZ2-40□2 | 9 | 17 | 9 |

* Specifications and dimensions other than the above are the same as the basic type (including narrow type).

Flat Type Fingers [3]

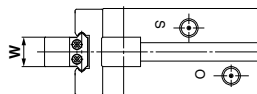
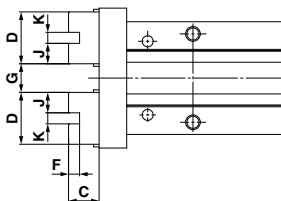
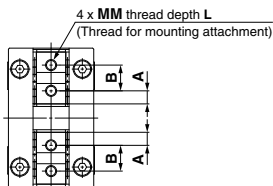

(mm)

| Model | A | B | C | D | F | G | | J | K | MM | L | W | Weight (g) |
|-----------------------------|------|-----|------|------|-----|-----------------------------------|----------------------------------|------|--------------------------------------|-------------|----|----------------------------------|-------------|
| | | | | | | Open | Closed | | | | | | |
| MHZ2-6□3 ⁽¹⁾ | 2 | 3.5 | 7.2 | 7.5 | — | 5 ^{+1.2} _{-0.8} | 1 ^{+0.2} ₀ | — | — | M2 x 0.4 | 3 | 4 ⁰ _{-0.05} | 26 |
| MHZ2-10□3 ⁽²⁾⁽³⁾ | 2.45 | 6 | 5.2 | 10.9 | 2 | 5.4 ^{+2.2} ₀ | 1.4 ⁰ _{-0.2} | 4.45 | 2H9 ^{+0.025} ₀ | M2.5 x 0.45 | 5 | 5 ⁰ _{-0.05} | 55 |
| MHZ2-16□3 ⁽²⁾⁽³⁾ | 3.05 | 8 | 8.3 | 14.1 | 2.5 | 7.4 ^{+2.2} ₀ | 1.4 ⁰ _{-0.2} | 5.8 | 2.5H9 ^{+0.025} ₀ | M3 x 0.5 | 6 | 8 ⁰ _{-0.05} | 115 |
| MHZ2-20□3 ⁽²⁾⁽³⁾ | 3.95 | 10 | 10.5 | 17.9 | 3 | 11.6 ^{+2.3} ₀ | 1.6 ⁰ _{-0.2} | 7.45 | 3H9 ^{+0.025} ₀ | M4 x 0.7 | 8 | 10 ⁰ _{-0.05} | 225 (230) |
| MHZ2-25□3 ⁽²⁾⁽³⁾ | 4.9 | 12 | 13.1 | 21.8 | 4 | 16 ^{+2.5} ₀ | 2 ⁰ _{-0.2} | 8.9 | 4H9 ^{+0.030} ₀ | M5 x 0.8 | 10 | 12 ⁰ _{-0.05} | 410 (415) |
| MHZ2-32□3 | 7.3 | 20 | 18 | 34.6 | 5 | 25 ^{+2.7} ₀ | 3 ⁰ _{-0.2} | 14.8 | 5H9 ^{+0.030} ₀ | M6 x 1 | 12 | 15 ⁰ _{-0.05} | 740 (785) |
| MHZ2-40□3 | 8.7 | 24 | 22 | 41.4 | 6 | 33 ^{+2.9} ₀ | 3 ⁰ _{-0.2} | 17.7 | 6H9 ^{+0.030} ₀ | M8 x 1.25 | 16 | 18 ⁰ _{-0.05} | 1335 (1430) |

Note 1) To mount attachments, use JISB1101 type M2 round head screws. Be careful not to use commercially available M2 hexagon socket head cap bolt as its top diameter is large.
 Note 2) Specifications and dimensions other than the above are the same as the basic type (including narrow type).
 Note 3) The overall length is the same as the MHQ(G) flat finger type.
 Note 4) The values inside () are for the single acting type.

Standard Type/MHZ2 Series

Body Option: End Boss Type

Applicable Model

| Symbol | Piping port location | Type of piping port | | | | Applicable model | | |
|--------|----------------------|--|---------|----------|---------|------------------|-----------------|---|
| | | MHZ2-10 | MHZ2-16 | MHZ2-20 | MHZ2-25 | Double acting | Single acting | |
| | | | | | | Normally open | Normally closed | |
| E | Side ported | M3 x 0.5 | | M5 x 0.8 | ● | ● | ● | |
| W | Axial ported | With $\phi 4$ One-touch fitting for coaxial tubing | | | | ● | — | — |
| K | | With $\phi 4$ One-touch fitting | | | | — | ● | ● |
| M | | M5 x 0.8 | | | | — | ● | ● |

Side Ported [E]

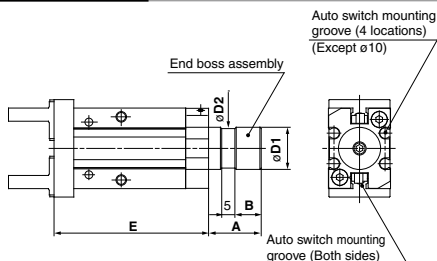

* Refer to the dimension table.

* When auto switches are used at the square groove on the side, side mounting with through-holes is not possible.

| Model | A | B | D1 | D2 | E |
|------------|----|----|--|----|------|
| MHZ2-10□□E | 15 | 7 | 12f8 ^{-0.016} _{-0.043} | 11 | 52.8 |
| MHZ2-16□□E | 20 | 10 | 16f8 ^{-0.016} _{-0.043} | 15 | 58.7 |
| MHZ2-20□□E | 22 | 12 | 20f8 ^{-0.020} _{-0.053} | 19 | 70.5 |
| MHZ2-25□□E | 25 | 15 | 25f8 ^{-0.020} _{-0.053} | 24 | 82.9 |

Other dimensions and specifications correspond to the standard type.

Axial Ported (with One-touch fitting for coaxial tubing) [W]

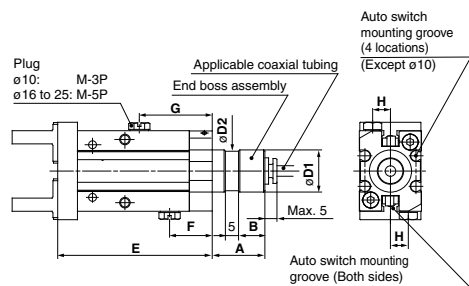

* Refer to the dimension table.

* When auto switches are used at the square groove on the side, side mounting with through-holes is not possible.

| Model | A | B | D1 | D2 | E | F | G | H |
|------------|----|----|--|----|------|------|------|-----|
| MHZ2-10D□W | 15 | 7 | 12f8 ^{-0.016} _{-0.043} | 11 | 52.8 | 18 | 28.3 | 5.5 |
| MHZ2-16D□W | 20 | 10 | 16f8 ^{-0.016} _{-0.043} | 15 | 58.7 | 16.2 | 27.7 | 6.5 |
| MHZ2-20D□W | 22 | 12 | 20f8 ^{-0.020} _{-0.053} | 19 | 70.5 | 18.2 | 31.2 | 7.5 |
| MHZ2-25D□W | 25 | 15 | 25f8 ^{-0.020} _{-0.053} | 24 | 82.9 | 19 | 31.8 | 10 |

Other dimensions and specifications correspond to the standard type.

Applicable Coaxial Tubing

Reference symbol

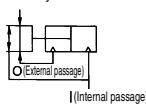

| Model | TW04B-20 |
|-------------------------|-------------|
| Specifications | |
| Outside diameter | 4 mm |
| Max. operating pressure | 0.6 MPa |
| Min. bending radius | 10 mm |
| Operating temperature | -20 to 60°C |
| Material | Nylon 12 |

Changing from Coaxial to Single Tubing

Changing to single tubing is possible by using a branch "Y" or branch tee fitting. In this case particularly, single tube fittings and tube for $\phi 3.2$ will be necessary.

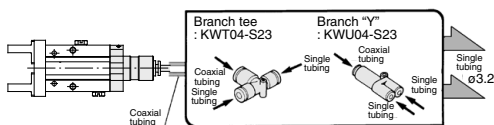

Branch Tee, Different Diameter Tee, Branch "Y", Male Run Tee

Please contact your SMC sales representative for details of the coaxial fittings and tubing.

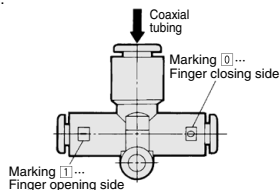

Axial Ported (with One-touch fitting) [K]

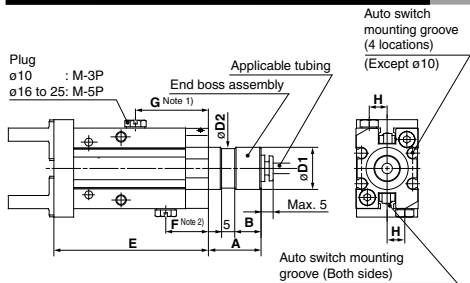

- * Refer to the dimension table.
- * When auto switches are used at the square groove on the side, side mounting with through-holes is not possible.

Note 1) Normally open type plug position.
 Note 2) Normally closed type plug position.
 The plug is mounted on only one side for the single acting type.

| | | (mm) | | | | | | | |
|---------|-------------------|------|----|--|----|------|------|------|-----|
| Model | | A | B | D1 | D2 | E | F | G | H |
| MHZ2-10 | $\frac{S}{C}$ □ K | 15 | 7 | 12f8 ^{-0.016} _{-0.043} | 11 | 52.8 | 18 | 28.3 | 5.5 |
| MHZ2-16 | $\frac{S}{C}$ □ K | 20 | 10 | 16f8 ^{-0.016} _{-0.043} | 15 | 58.7 | 16.2 | 27.7 | 6.5 |
| MHZ2-20 | $\frac{S}{C}$ □ K | 22 | 12 | 20f8 ^{-0.020} _{-0.053} | 19 | 70.5 | 18.2 | 31.2 | 7.5 |
| MHZ2-25 | $\frac{S}{C}$ □ K | 25 | 15 | 25f8 ^{-0.020} _{-0.053} | 24 | 82.9 | 19 | 31.8 | 10 |

Other dimensions and specifications correspond to the standard type.

Applicable Tubing

| Description/Model | Nylon tubing | Soft nylon tubing | Polyurethane tubing | Polyurethane coil tubing |
|-------------------------------|--------------|-------------------|---------------------|--------------------------|
| | T0425 | TS0425 | TU0425 | TCU0425B-1 |
| Outside diameter (mm) | 4 | 4 | 4 | 4 |
| Max. operating pressure (MPa) | 1.0 | 0.8 | 0.5 | 0.5 |
| Min. bending radius (mm) | 13 | 12 | 10 | — |
| Operating temperature (°C) | -20 to 60 | -20 to 60 | -20 to 60 | -20 to 60 |
| Material | Nylon 12 | Nylon 12 | Polyurethane | Polyurethane |

Refer to "Best Pneumatics No. 7" regarding One-touch fittings and tubing.

Axial Ported (with M5 Port) [M]

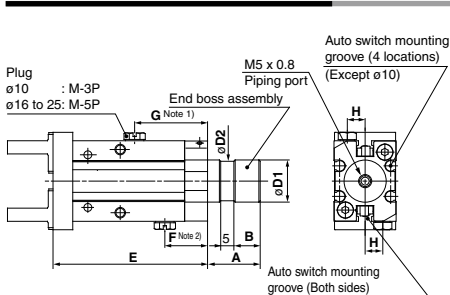

- * Refer to the dimension table.
- * When auto switches are used at the square groove on the side, side mounting with through-holes is not possible.

Note 1) Normally open type plug position.
 Note 2) Normally closed type plug position.
 The plug is mounted on only one side for the single acting type.

| | | (mm) | | | | | | | |
|---------|-------------------|------|----|--|----|------|------|------|-----|
| Model | | A | B | D1 | D2 | E | F | G | H |
| MHZ2-10 | $\frac{S}{C}$ □ M | 15 | 7 | 12f8 ^{-0.016} _{-0.043} | 11 | 52.8 | 18 | 28.3 | 5.5 |
| MHZ2-16 | $\frac{S}{C}$ □ M | 20 | 10 | 16f8 ^{-0.016} _{-0.043} | 15 | 58.7 | 16.2 | 27.7 | 6.5 |
| MHZ2-20 | $\frac{S}{C}$ □ M | 22 | 12 | 20f8 ^{-0.020} _{-0.053} | 19 | 70.5 | 18.2 | 31.2 | 7.5 |
| MHZ2-25 | $\frac{S}{C}$ □ M | 25 | 15 | 25f8 ^{-0.020} _{-0.053} | 24 | 82.9 | 19 | 31.8 | 10 |

Other dimensions and specifications correspond to the standard type.

Weight

| Model | End boss type (Symbol) | | | |
|-------------|------------------------|-----|-----|-----|
| | E | W | K | M |
| MHZ2-10 □ □ | 65 | 64 | 66 | 65 |
| MHZ2-16 □ □ | 148 | 147 | 148 | 147 |
| MHZ2-20 □ □ | 272 | 277 | 277 | 277 |
| MHZ2-25 □ □ | 485 | 495 | 496 | 494 |

- MHZ**
- MHF
- MHL
- MHR
- MHK
- MHS
- MHC
- MHT
- MHY
- MHW
- X □
- MRHQ
- MA
- D-□

Parallel Type Air Gripper/Long Stroke Type

MHZL2 Series

ø10, ø16, ø20, ø25

How to Order

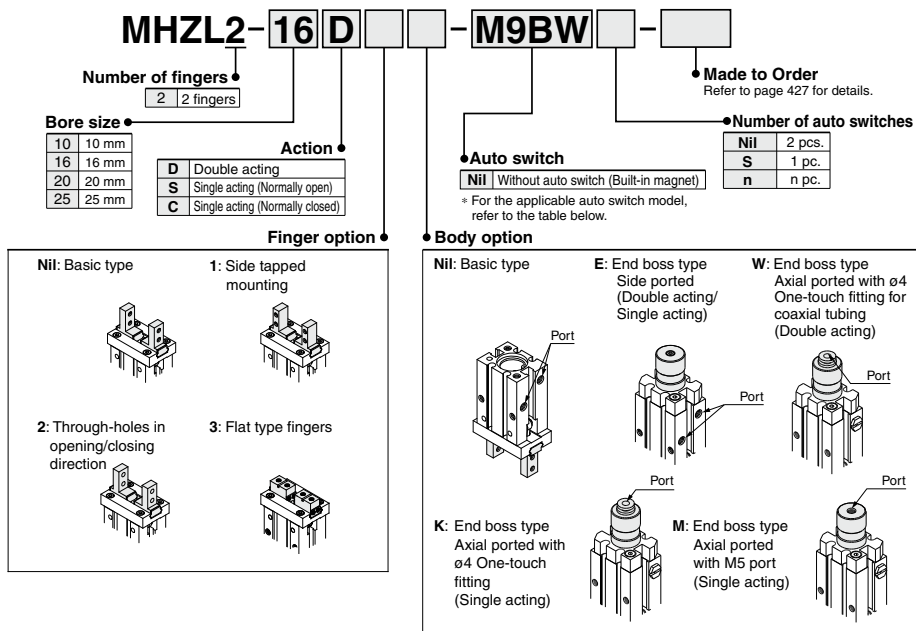

Applicable Auto Switches

Refer to pages 797 to 850 for further information on the auto switch.

| Type | Special function | Electrical entry | Indicator light | Wiring (Output) | Load voltage | | Auto switch model | | Lead wire length (m) * | | | | | Applicable model | Pre-wired connector | Applicable load | | | |
|-------------------------|-------------------------------|------------------|-----------------|-----------------|--------------|------|----------------------------|---------------|------------------------|-------|-------|-------|-----|------------------|---------------------|-----------------|------------|-----|-----|
| | | | | | DC | AC | Electrical entry direction | | 0.5 (Nil) | 1 (M) | 3 (L) | 5 (Z) | ø10 | | | | ø16 | ø20 | ø25 |
| | | | | | | | Perpendicular | In-line | | | | | | | | | | | |
| Solid state auto switch | — | Grommet | Yes | 3-wire (NPN) | 5V, 12 V | 24 V | — | M9NV | M9N | ● | ● | ○ | ● | ● | ● | ○ | IC circuit | | |
| | | | | F8N | | | | M9P | — | — | — | — | ● | ● | ● | — | | | |
| | | | | M9PV | | | | M9P | ● | ● | ● | ○ | ● | ● | ● | ● | | ○ | |
| | | | | F8P | | | | M9B | ● | — | ● | ○ | — | — | — | — | | — | |
| | | | | M9BV | | | | M9B | ● | — | ● | ○ | — | — | — | — | | — | |
| | | | | F8B | | | | M9B | ● | — | ● | ○ | — | — | — | — | | — | |
| | Diagnosis (2-color indicator) | Grommet | Yes | 3-wire (NPN) | 5V, 12 V | 24 V | — | M9NWV | M9NW | ● | ● | ○ | ● | ● | ● | ○ | IC circuit | | |
| | | | | M9PVV | | | | M9PW | ● | ● | ○ | ● | ● | ● | ● | ○ | | | |
| | | | | M9BWW | | | | M9BW | ○ | ● | ● | ○ | ● | ● | ● | ○ | | | |
| | | | | M9NAV** | | | | M9NA** | ○ | ○ | ● | ○ | ● | ● | ● | ○ | | | |
| | | | | M9PAV** | | | | M9PA** | ○ | ○ | ○ | ○ | ● | ● | ● | ○ | | | |
| | | | | M9BAV** | | | | M9BA** | ○ | ○ | ● | ○ | ● | ● | ● | ○ | | | |

** Water resistant type auto switches can be mounted on the above models, but in such case SMC cannot guarantee water resistance.

* Lead wire length symbols: 0.5 m..... Nil (Example) M9NW

1 m..... M (Example) M9NW

3 m..... L (Example) M9NL

5 m..... Z (Example) M9NZ

* Solid state auto switches marked with ○ are produced upon receipt of order.

Note 1) When using the 2-color indicator type, please make the setting so that the indicator is lit in red to ensure the detection at the proper position of the air gripper.

Note 2) Through-hole mounting is not possible when using the auto switch at the square groove on the side.

Note 3) When the product is ordered with auto switch, only MHZL2-10 is shipped with the auto switch mounting brackets. When the auto switch is used at the square groove on the side with MHZL2-16 to 25, mounting brackets (BMG2-012) are required. Order them separately. Refer to page 457 for the auto switch mounting brackets.

Specifications



| Fluid | | Air |
|---------------------------------------|---|---|
| Operating pressure | Double acting | $\phi 10$: 0.2 to 0.7 MPa $\phi 16$ to $\phi 25$: 0.1 to 0.7 MPa |
| | Single acting Normally open acting Normally closed | $\phi 10$: 0.35 to 0.7 MPa $\phi 16$ to $\phi 25$: 0.25 to 0.7 MPa |
| Ambient and fluid temperature | | -10 to 60°C |
| Repeatability | | ±0.01 mm |
| Max. operating frequency | | 120 c.p.m. |
| Lubrication | | Not required |
| Action | | Double acting/Single acting |
| Auto switch (Option) ^{Note)} | | Solid state auto switch (3-wire, 2-wire) |

Note) Refer to pages 797 to 850 for further information on auto switches.

Symbol

Double acting:
Internal grip

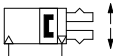

Double acting:
External grip

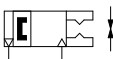

Single acting/
Normally closed: Internal grip

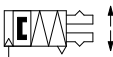

Single acting/
Normally open: External grip



Refer to pages 454 to 458 for the specifications with auto switch.

- Auto switch installation examples and mounting positions
- Auto switch hysteresis
- Auto switch mounting
- Protrusion of auto switch from edge of body



Made to Order Individual Specifications
(Refer to pages 436 to 439 for details.)

| Symbol | Specifications/Description |
|--------|----------------------------|
| -X6110 | With dust cover |

Made to Order

[Click here for details](#)

| Symbol | Specifications/Description |
|--------|--|
| -X4 | Heat resistance (100°C) |
| -X5 | Fluororubber seal |
| -X7 | Closing direction spring assist |
| -X12 | Opening direction spring assist |
| -X50 | Without magnet |
| -X53 | EPDM seal/Fluorine grease |
| -X56 | Axial ported type |
| -X63 | Fluorine grease |
| -X79 | Grease for food processing machines, Fluorine grease |
| -X79A | Grease for food processing machines |
| -X81A | Anti-corrosive treatment of finger |
| -X81B | Anti-corrosive treatment of finger and guide |

Model

| Action | Model | Bore size (mm) | Gripping force ^{Note 1)} | | Opening/Closing stroke (Both sides) (mm) | Weight ^{Note 2)} (g) | |
|---------------|-----------------|----------------|---|----------|--|-------------------------------|-----|
| | | | Gripping force per finger Effective value (N) | | | | |
| | | | External | Internal | | | |
| Double acting | MHZL2-10D | 10 | 11 | 17 | 8 | 60 | |
| | MHZL2-16D | 16 | 34 | 45 | 12 | 135 | |
| | MHZL2-20D | 20 | 42 | 66 | 18 | 270 | |
| | MHZL2-25D | 25 | 65 | 104 | 22 | 470 | |
| Single acting | Normally open | MHZL2-10S | 10 | 7.1 | — | 8 | 70 |
| | | MHZL2-16S | 16 | 27 | | 12 | 145 |
| | | MHZL2-20S | 20 | 33 | | 18 | 290 |
| | | MHZL2-25S | 25 | 50 | | 22 | 515 |
| | Normally closed | MHZL2-10C | 10 | — | 13 | 8 | 70 |
| | | MHZL2-16C | 16 | | 38 | 12 | 145 |
| | | MHZL2-20C | 20 | | 57 | 18 | 290 |
| | | MHZL2-25C | 25 | | 85 | 22 | 515 |

Note 1) Values based on pressure of 0.5 MPa, gripping point L = 20 mm, at center of stroke.

Note 2) Values excluding weight of auto switch.

Option

● Body Option/End Boss Type

| Symbol | Piping port location | Type of piping port | | | | Applicable model | | |
|--------|----------------------|--|----------|----------|----------|------------------|---------------|---|
| | | MHZL2-10 | MHZL2-16 | MHZL2-20 | MHZL2-25 | Double acting | Single acting | |
| Nil | Basic type | M3 x 0.5 | M5 x 0.8 | | | ● | ● | |
| E | Side ported | M3 x 0.5 | M5 x 0.8 | | | ● | ● | |
| W | Axial ported | With $\phi 4$ One-touch fitting for coaxial tubing | | | | | ● | — |
| K | Axial ported | With $\phi 4$ One-touch fitting | | | | | — | ● |
| M | Axial ported | M5 x 0.8 | | | | | — | ● |

* For detailed body option specifications, refer to option specifications on pages 434 and 435.

Moisture Control Tube IDK Series



When operating an actuator with a small diameter and a short stroke at a high frequency, the dew condensation (water droplet) may occur inside the piping depending on the conditions.

Simply connecting the moisture control tube to the actuator will prevent dew condensation from occurring. For details, refer to [the IDK series in the Best Pneumatics No. 6](#).

MHZL2 Series

Construction: MHZL2-10□ to 25□

Double acting/With fingers open

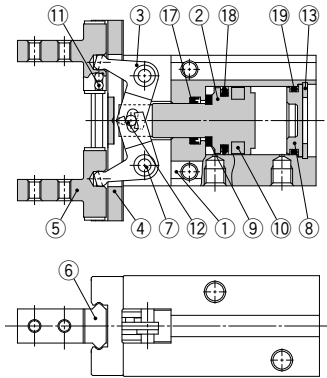

Single acting/Normally open

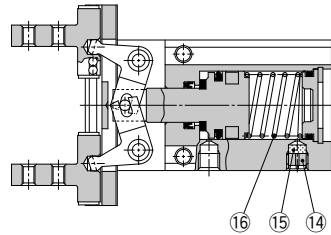

Double acting/With fingers closed

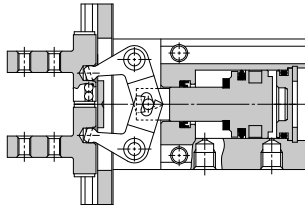

Single acting/Normally closed

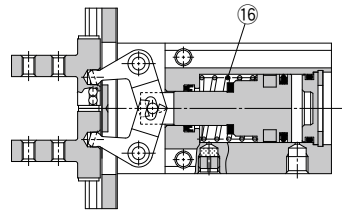

Component Parts

| No. | Description | Material | Note |
|-----|----------------|---|----------------|
| 1 | Body | Aluminum alloy | Hard anodized |
| 2 | Piston | ø10, ø16: Stainless steel ø20, ø25: Aluminum alloy | Hard anodized |
| 3 | Lever | Stainless steel | Nitriding |
| 4 | Guide | Stainless steel | Heat treated |
| 5 | Finger | Stainless steel | Heat treated |
| 6 | Roller stopper | Stainless steel | |
| 7 | Lever shaft | Stainless steel | Nitriding |
| 8 | Cap | Aluminum alloy | Clear anodized |
| 9 | Bumper | Urethane rubber | |

Component Parts

| No. | Description | Material | Note |
|-----|-----------------------|----------------------------------|---------------------------|
| 10 | Rubber magnet | Synthetic rubber | |
| 11 | Steel balls | High carbon chrome bearing steel | |
| 12 | Needle roller | High carbon chrome bearing steel | |
| 13 | Type C retaining ring | Carbon steel | Phosphate coated |
| 14 | Exhaust plug A | Brass | Electroless nickel plated |
| 15 | Exhaust filter A | Polyvinyl formal | |
| 16 | Spring | Stainless steel spring wire | |
| 17 | Rod seal | NBR | |
| 18 | Piston seal | NBR | |
| 19 | Gasket | NBR | |

Replacement Parts

| Description | | MHZL2-10 | MHZL2-16 | MHZL2-20 | MHZL2-25 | Main parts |
|-------------------|-------------|---------------|---------------|---------------|---------------|--|
| Seal kit | | MHZL10-PS | MHZL16-PS | MHZL20-PS | MHZL25-PS | ⑰⑱⑲ |
| Finger assembly | MHZL2-□□□ | MHZL-AA1002 | MHZL-AA1602 | MHZL-AA2002 | MHZL-AA2502 | ④⑤⑥⑱ |
| | MHZL2-□□□1 | MHZL-AA1002-1 | MHZL-AA1602-1 | MHZL-AA2002-1 | MHZL-AA2502-1 | |
| | MHZL2-□□□2 | MHZL-AA1002-2 | MHZL-AA1602-2 | MHZL-AA2002-2 | MHZL-AA2502-2 | |
| Piston assembly | MHZL2-□□□3 | MHZL-AA1002-3 | MHZL-AA1602-3 | MHZL-AA2002-3 | MHZL-AA2502-3 | ②⑨⑩⑫ |
| | MHZL2-□□□D | MHZL-A1003 | MHZL-A1603 | MHZL-A2003 | MHZL-A2503 | |
| | MHZL2-□□□S | MHZL-A1003C | MHZL-A1603C | MHZL-A2003C | MHZL-A2503C | |
| End boss assembly | MHZL2-□□□CW | MHZ-A1007 | MHZ-A1607 | MHZ-A2007 | MHZ-A2507 | Main body of adaptor Mounting screw for adaptor Seal kit |
| | MHZL2-□□□K | MHZ-A1008 | MHZ-A1608 | MHZ-A2008 | MHZ-A2508 | |
| | MHZL2-□□□CM | MHZ-A1009 | MHZ-A1609 | MHZ-A2009 | MHZ-A2509 | |
| | MHZL2-□□□E | MHZ-A1010 | MHZ-A1610 | MHZ-A2010 | MHZ-A2510 | |
| Lever assembly | | MHZL-A1004 | MHZL-A1604 | MHZL-A2004 | MHZL-A2504 | ③⑦ |

* Finger option

1 = Side tapped, 2 = Through-hole, 3 = Flat type fingers

* End boss type

W = One-touch-fitting for coaxial tubing, K = With One-touch fitting, M = With M5 port, E = Side ported

* The end boss assembly other than type E should be mounted on the special body.

Replacement part/Grease pack part no.: GR-S-010 (10 g)

Dimensions

MHZL2-10 □ Double acting/Single acting

Basic type

The values inside () are dimensions for the single acting type.

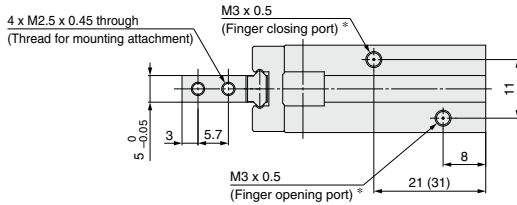
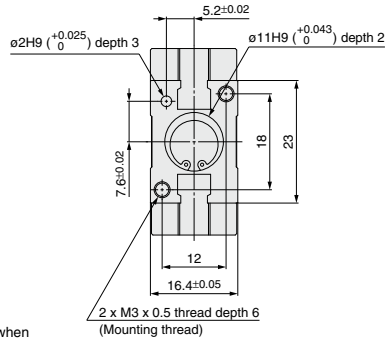
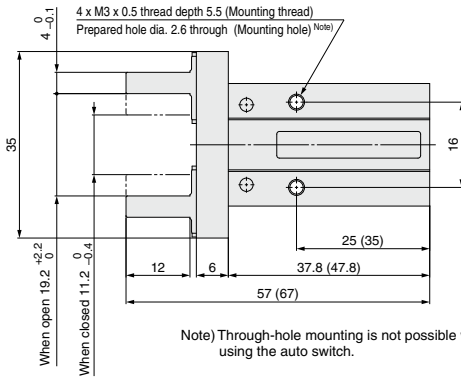
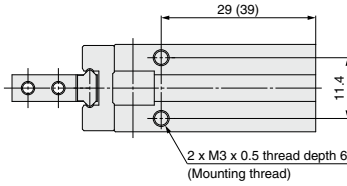

* For single action, the port on one side is a breathing hole.

Auto Switch Mounting Groove Dimensions

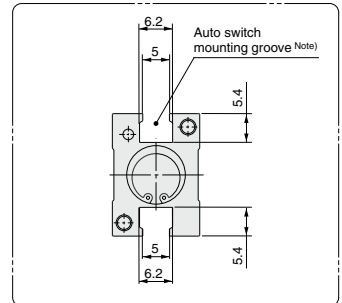

Note) Through-hole mounting is not possible when using the auto switch at the square groove.

MHZ

MHF

MHL

MHR

MHK

MHS

MHC

MHT

MHY

MHW

-X □

MRHQ

MA

D- □

MHZL2 Series

Dimensions

MHZL2-16 □ Double acting/Single acting

Basic type

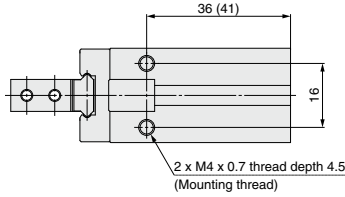

The values inside () are dimensions for the single acting type.

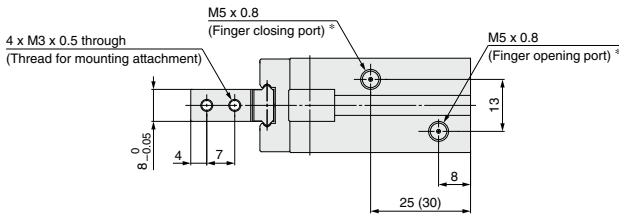
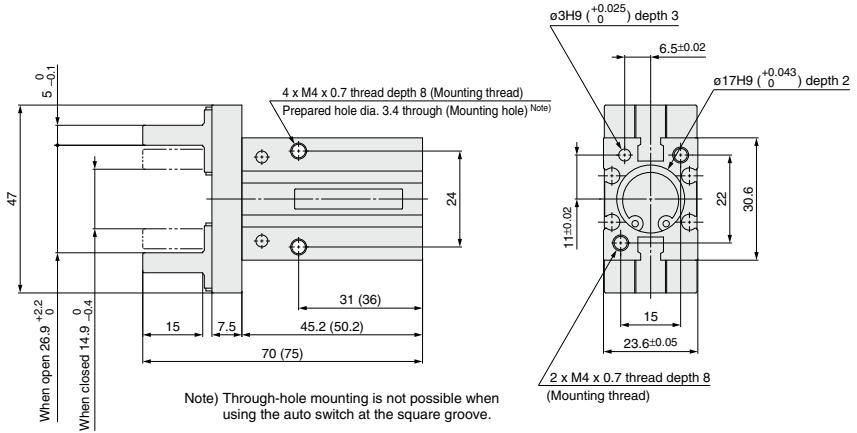

*For single action, the port on one side is a breathing hole.

Auto Switch Mounting Groove Dimensions

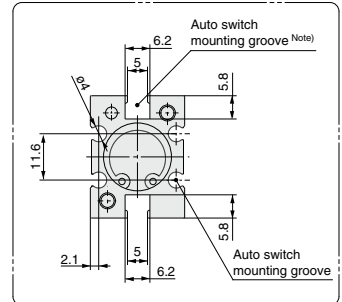

Note) Through-hole mounting is not possible when using the auto switch at the square groove.

MHZL2-20□ Double acting/Single acting Basic type

The values inside () are dimensions for the single acting type.

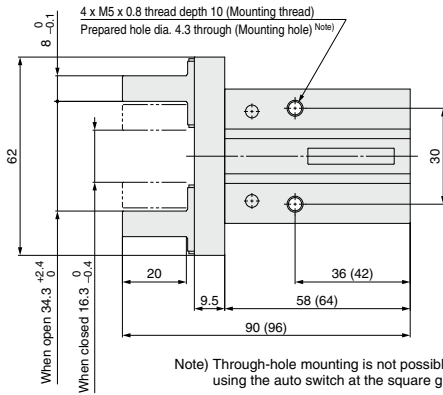
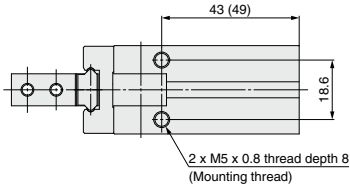

Note) Through-hole mounting is not possible when using the auto switch at the square groove.

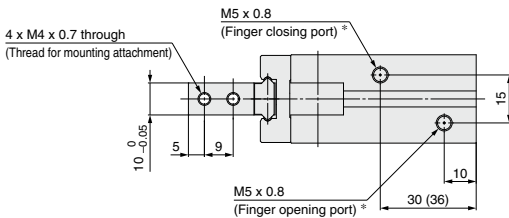
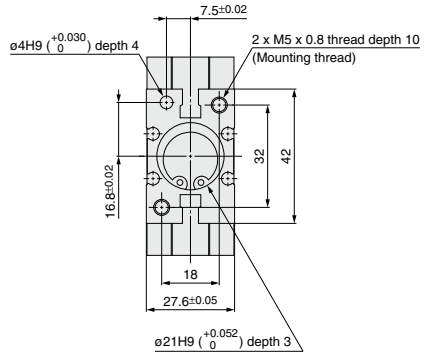

* For single action, the port on one side is a breathing hole.

Auto Switch Mounting Groove Dimensions

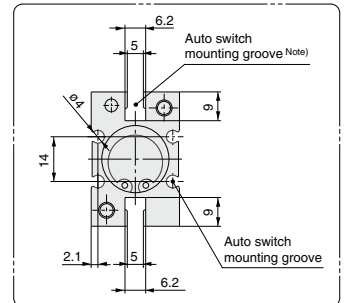

Note) Through-hole mounting is not possible when using the auto switch at the square groove.

MHZ

MHF

MHL

MHR

MHK

MHS

MHC

MHT

MHY

MHW

-X□

MRHQ

MA

D-□

Long Stroke Type/MHZL2 Series Finger Option

Side Tapped Mounting [1]

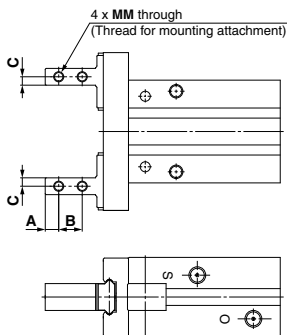

(mm)

| Model | A | B | C | MM |
|-------------|---|-----|-----|-------------|
| MHZL2-10□1□ | 3 | 5.7 | 2 | M2.5 x 0.45 |
| MHZL2-16□1□ | 4 | 7 | 2.5 | M3 x 0.5 |
| MHZL2-20□1□ | 5 | 9 | 4 | M4 x 0.7 |
| MHZL2-25□1□ | 6 | 12 | 5 | M5 x 0.8 |

* Specifications and dimensions other than the above are the same as the basic type.

Through-holes in Opening/ Closing Direction [2]

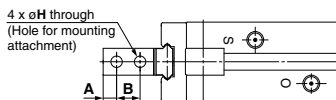
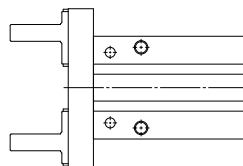

(mm)

| Model | A | B | H |
|-------------|---|-----|-----|
| MHZL2-10□2□ | 3 | 5.7 | 2.9 |
| MHZL2-16□2□ | 4 | 7 | 3.4 |
| MHZL2-20□2□ | 5 | 9 | 4.5 |
| MHZL2-25□2□ | 6 | 12 | 5.5 |

* Specifications and dimensions other than the above are the same as the basic type.

Flat Type Fingers [3]

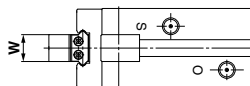
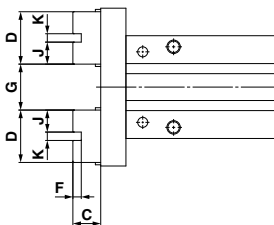
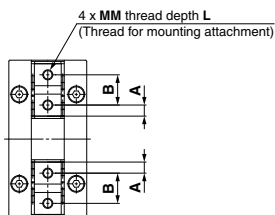

(mm)

| Model | A | B | C | D | F | G | | J | K | MM | L | W | Weight (g) | |
|-------------|------|----|------|------|-----|-----------------------------------|----------------------------------|------|--------------------------------------|-------------|----|----------------------------------|---------------|---------------|
| | | | | | | Open | Closed | | | | | | Double acting | Single acting |
| MHZL2-10□3□ | 2.45 | 7 | 5.2 | 11.9 | 2 | 9.4 ^{+2.2} ₀ | 1.4 ⁰ _{-0.2} | 4.95 | 2H9 ^{+0.025} ₀ | M2.5 x 0.45 | 5 | 5 ⁰ _{-0.05} | 60 | 70 |
| MHZL2-16□3□ | 3.3 | 9 | 8.3 | 15.7 | 2.5 | 13.4 ^{+2.2} ₀ | 1.4 ⁰ _{-0.2} | 6.55 | 2.5H9 ^{+0.025} ₀ | M3 x 0.5 | 6 | 8 ⁰ _{-0.05} | 135 | 145 |
| MHZL2-20□3□ | 3.95 | 12 | 10.5 | 19.9 | 3 | 19.6 ^{+2.4} ₀ | 1.6 ⁰ _{-0.2} | 8.45 | 3H9 ^{+0.025} ₀ | M4 x 0.7 | 8 | 10 ⁰ _{-0.05} | 270 | 290 |
| MHZL2-25□3□ | 4.9 | 14 | 13.1 | 23.8 | 4 | 24 ^{+2.6} ₀ | 2 ⁰ _{-0.2} | 9.9 | 4H9 ^{+0.030} ₀ | M5 x 0.8 | 10 | 12 ⁰ _{-0.05} | 460 | 505 |

* Specifications and dimensions other than the above are the same as the basic type.

MHZ

MHF

MHL

MHR

MHK

MHS

MHC

MHT

MHY

MHW

-X□

MRHQ

MA

D-□

Long Stroke Type/MHZL2 Series

Body Option: End Boss Type

Applicable Model

| Symbol | Piping port location | Type of piping port | | | | Applicable model | | |
|--------|----------------------|--|----------|----------|----------|------------------|---------------|---|
| | | MHZL2-10 | MHZL2-16 | MHZL2-20 | MHZL2-25 | Double acting | Single acting | |
| E | Side ported | M3 x 0.5 | | M5 x 0.8 | | ● | ● | ● |
| W | Axial ported | With $\phi 4$ One-touch fitting for coaxial tubing | | | | ● | — | — |
| K | | With $\phi 4$ One-touch fitting | | | | — | ● | ● |
| M | | M5 x 0.8 | | | | — | ● | ● |

Side Ported [E]

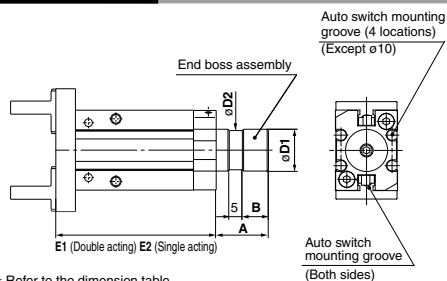

- * Refer to the dimension table.
- * When auto switches are used at the square groove on the side, side mounting with through-holes is not possible.

| Model | A | B | D1 | D2 | E1 | E2 |
|-------------|----|----|--|----|------|------|
| MHZL2-10□□E | 15 | 7 | 12f8 ^{-0.016} _{-0.043} | 11 | 52.8 | 62.8 |
| MHZL2-16□□E | 20 | 10 | 16f8 ^{-0.016} _{-0.043} | 15 | 61.4 | 66.4 |
| MHZL2-20□□E | 22 | 12 | 20f8 ^{-0.020} _{-0.053} | 19 | 75.7 | 81.7 |
| MHZL2-25□□E | 25 | 15 | 25f8 ^{-0.020} _{-0.053} | 24 | 86.2 | 96.2 |

Other dimensions and specifications correspond to the standard type.

Axial Ported (with One-touch fitting for coaxial tubing) [W]

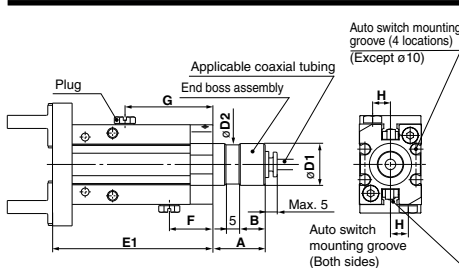

- * Refer to the dimension table.
- * When auto switches are used at the square groove on the side, side mounting with through-holes is not possible.

| Model | A | B | D1 | D2 | E1 |
|-------------|----|----|--|----|------|
| MHZL2-10D□W | 15 | 7 | 12f8 ^{-0.016} _{-0.043} | 11 | 52.8 |
| MHZL2-16D□W | 20 | 10 | 16f8 ^{-0.016} _{-0.043} | 15 | 61.4 |
| MHZL2-20D□W | 22 | 12 | 20f8 ^{-0.020} _{-0.053} | 19 | 75.7 |
| MHZL2-25D□W | 25 | 15 | 25f8 ^{-0.020} _{-0.053} | 24 | 86.2 |

Other dimensions and specifications correspond to the standard type.

Applicable Coaxial Tubing Type W

| Model | TW04B-20 | | |
|-------------------------|-------------|--|--|
| Specifications | | | |
| Outside diameter | 4 mm | | |
| Max. operating pressure | 0.6 MPa | | |
| Min. bending radius | 10 mm | | |
| Operating temperature | -20 to 60°C | | |
| Material | Nylon 12 | | |

| | F | G | H |
|-----------|------|------|-----|
| $\phi 10$ | 17 | 30 | 5.5 |
| $\phi 16$ | 16.7 | 33.7 | 6.5 |
| $\phi 20$ | 18.2 | 38.2 | 7.5 |
| $\phi 25$ | 18.3 | 41.3 | 10 |

Changing from Coaxial to Single Tubing

Changing to single tubing is possible by using a branch "Y" or branch tee fitting. In this case particularly, single tube fittings and tubing for $\phi 3.2$ will be necessary.

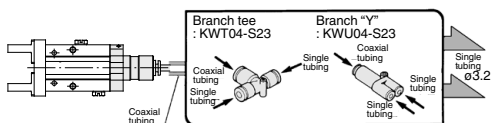

Branch tee, Different diameter tee, Branch "Y", Male run tee

Please contact your SMC sales representative for details of the coaxial fittings and tubing.

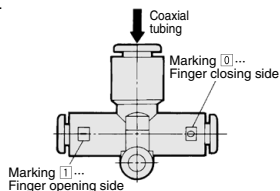

Axial Ported (with One-touch fitting) [K]

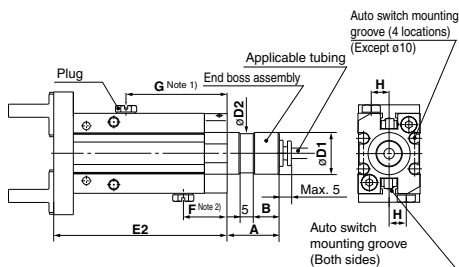

* Refer to the dimension table.
 * When auto switches are used at the square groove on the side, side mounting with through-holes is not possible.

Note 1) Normally open type plug position.
 Note 2) Normally closed type plug position.
 The plug is mounted on only one side for the single acting type.

| Model | A | B | D1 | D2 | E2 |
|---------------------------------------|----|----|--|----|------|
| MH _Z L2-10 ^S □K | 15 | 7 | 12f8 ^{-0.016} _{-0.043} | 11 | 62.8 |
| MH _Z L2-16 ^S □K | 20 | 10 | 16f8 ^{-0.016} _{-0.043} | 15 | 66.4 |
| MH _Z L2-20 ^S □K | 22 | 12 | 20f8 ^{-0.020} _{-0.053} | 19 | 81.7 |
| MH _Z L2-25 ^S □K | 25 | 15 | 25f8 ^{-0.020} _{-0.053} | 24 | 96.2 |

Other dimensions and specifications correspond to the standard type.

Applicable Tubing

| Description/ Model | Nylon tubing | Soft nylon tubing | Polyurethane tubing | Polyurethane coil tubing |
|-------------------------------|-----------------|----------------------|------------------------|-----------------------------|
| | T0425 | TS0425 | TU0425 | TCU0425B4 |
| Outside diameter (mm) | 4 | 4 | 4 | 4 |
| Max. operating pressure (MPa) | 1.0 | 0.8 | 0.5 | 0.5 |
| Min. bending radius (mm) | 13 | 12 | 10 | — |
| Operating temperature (°C) | -20 to 60 | -20 to 60 | -20 to 60 | -20 to 60 |
| Material | Nylon 12 | Nylon 12 | Polyurethane | Polyurethane |

Refer to "Pneumatic Piping Equipment (CAT. E50)" regarding One-touch fittings and tubing.

Type K

| | F | G | H |
|-----|------|------|-----|
| ø10 | 17 | 40 | 5.5 |
| ø16 | 16.7 | 38.7 | 6.5 |
| ø20 | 18.2 | 44.2 | 7.5 |
| ø25 | 18.3 | 51.3 | 10 |

Axial Ported (with M5 port) [M]

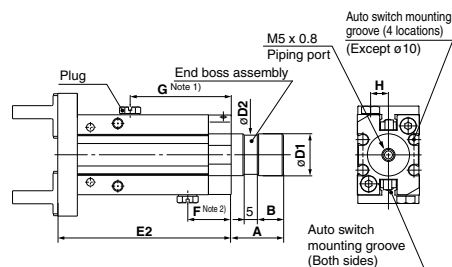

* Refer to the dimension table.
 * When auto switches are used at the square groove on the side, side mounting with through-holes is not possible.

Note 1) Normally open type plug position.
 Note 2) Normally closed type plug position.
 The plug is mounted on only one side for the single acting type.

| Model | A | B | D1 | D2 | E2 |
|---------------------------------------|----|----|--|----|------|
| MH _Z L2-10 ^S □M | 15 | 7 | 12f8 ^{-0.016} _{-0.043} | 11 | 62.8 |
| MH _Z L2-16 ^S □M | 20 | 10 | 16f8 ^{-0.016} _{-0.043} | 15 | 66.4 |
| MH _Z L2-20 ^S □M | 22 | 12 | 20f8 ^{-0.020} _{-0.053} | 19 | 81.7 |
| MH _Z L2-25 ^S □M | 25 | 15 | 25f8 ^{-0.020} _{-0.053} | 24 | 96.2 |

Other dimensions and specifications correspond to the standard type.

Type M

| | F | G | H |
|-----|------|------|-----|
| ø10 | 17 | 40 | 5.5 |
| ø16 | 16.7 | 38.7 | 6.5 |
| ø20 | 18.2 | 44.2 | 7.5 |
| ø25 | 18.3 | 51.3 | 10 |

Weight

| Model | End boss type (Symbol) | | | | |
|--------------------------|------------------------|---------------|-----|-----|-----|
| | E | | W | K | M |
| | Double acting | Single acting | | | |
| MH _Z L2□-10□□ | 70 | 80 | 70 | 80 | 80 |
| MH _Z L2□-16□□ | 170 | 180 | 170 | 180 | 180 |
| MH _Z L2□-20□□ | 310 | 330 | 310 | 330 | 330 |
| MH _Z L2□-25□□ | 535 | 580 | 535 | 580 | 580 |

MHZL2 Series

Made to Order Individual Specifications

Please contact SMC for detailed dimensions, specifications and lead times.



1 With dust cover (For MHZL10, 16, 20)

Symbol
-X6110

Long stroke type (size 10, 16, 20) with dust cover

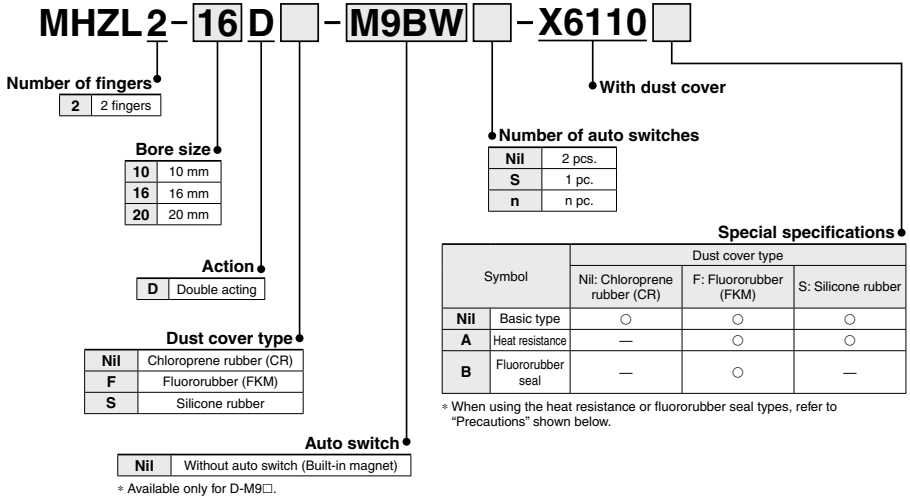

Specifications

| Model | Basic type | Heat resistance | Fluororubber seal |
|-------------------------------------|---------------------------|-----------------|-------------------|
| Ambient and fluid temperature | -10 to 60°C | -10 to 100°C | -10 to 60°C |
| Specifications other than the above | Same as the standard type | | |

Model

| Action | Model | Bore size (mm) | Gripping force ^{Note 1)} | | Opening/Closing stroke (Both sides) (mm) | Weight ^{Note 2)} (g) |
|---------------|------------------|----------------|---|----------|--|-------------------------------|
| | | | Gripping force per finger Effective value (N) | | | |
| | | | External | Internal | | |
| Double acting | MHZL2-10D-X6110□ | 10 | 11 | 17 | 8 | 85 |
| | MHZL2-16D-X6110□ | 16 | 34 | 45 | 12 | 150 |
| | MHZL2-20D-X6110□ | 20 | 42 | 66 | 18 | 385 |

Note 1) Values based on pressure of 0.5 MPa, gripping point L = 20 mm, at center of stroke.

Note 2) Values excluding weight of auto switch.

⚠ Precautions

For heat resistance

⚠ Warning

Be aware that smoking cigarettes after your hands have come into contact with the grease used for this air gripper can create a gas that is hazardous to humans.

⚠ Caution

- Note 1) Magnet is built-in, but when using an auto switch, the acceptable temperature range becomes -10 to 60°C.
- Note 2) For the dust cover option part number, only fluororubber (F) or silicone rubber (S) can be selected.
- Note 3) For lubrication, specialized grease GR-F is recommended.

For fluororubber seal

⚠ Caution

- Note 1) Consult with SMC, since the type of chemical and the operating temperature may not allow the use of this product.
- Note 2) Since the standard-type magnet is built-in, consult with SMC for the product's adaptability to the operating environment.
- Note 3) The dust cover material is also fluororubber. Thus, enter (F) for the fluororubber dust cover in the part number.



Dimensions

MHZL2-10D□-X6110
Basic type/Double acting

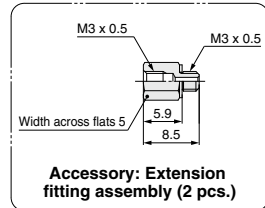
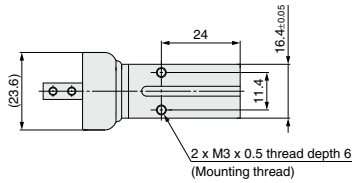

* When using the perpendicular type (D-M9□V) switch, use an extension fitting since the switch interferes with the One-touch fitting.

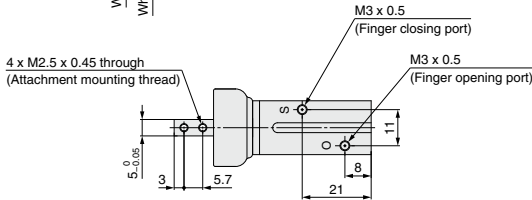
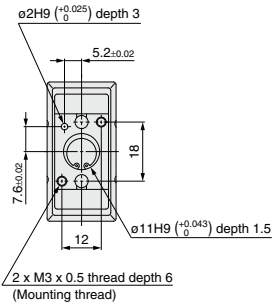
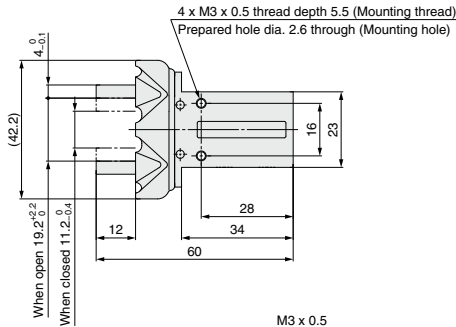

Auto Switch Mounting Groove Dimensions

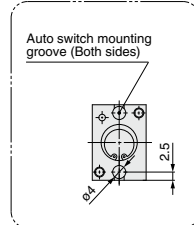

* The dimensions of the heat resistance or fluororubber seal types are the same as those shown above.

MHZ

MHF

MHL

MHR

MHK

MHS

MHC

MHT

MHY

MHW

-X□

MRHQ

MA

D-□

MHZL2 Series

Dimensions

MHZL2-16D□-X6110 Basic type/Double acting

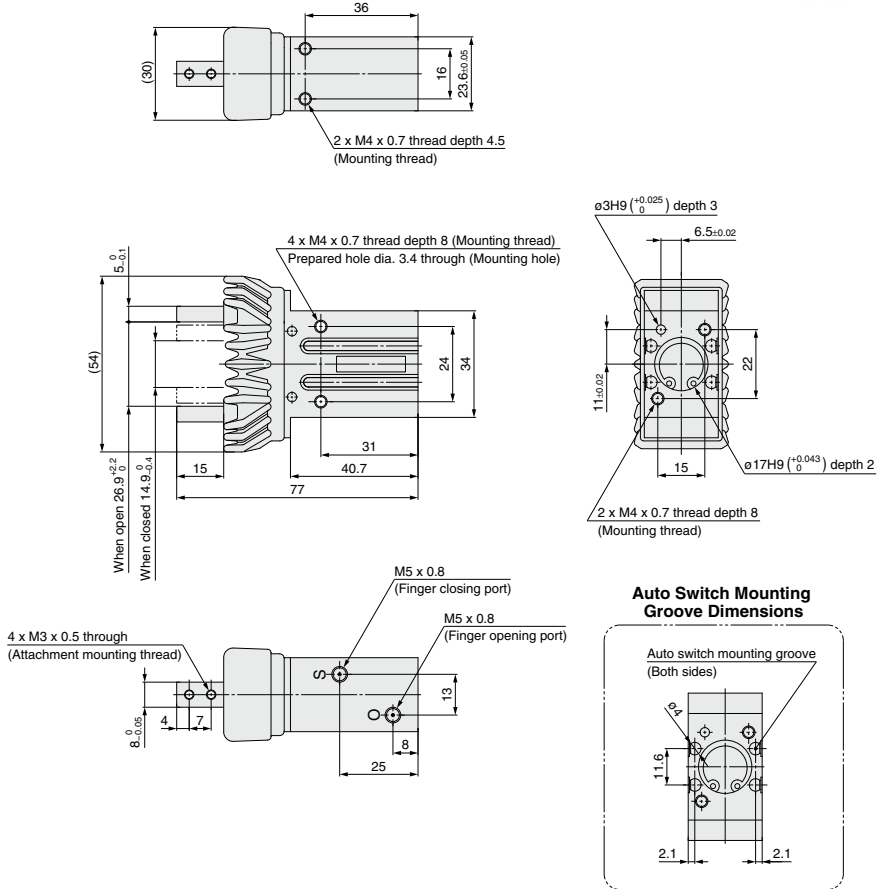

* The dimensions of the heat resistance or fluororubber seal types are the same as those shown above.

Dimensions

MHZL2-20D□-X6110
Basic type/Double acting

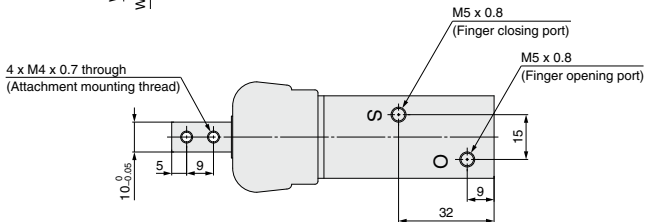
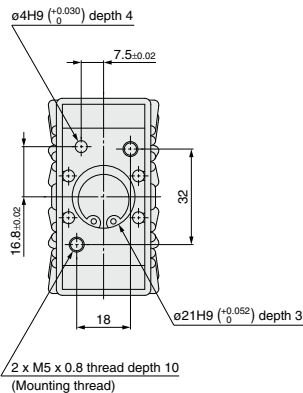
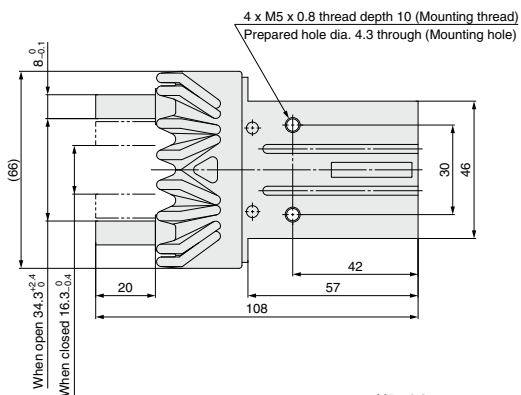
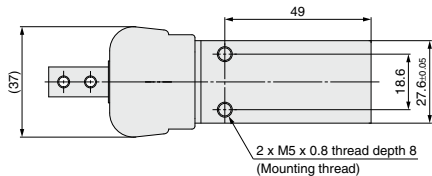

Auto Switch Mounting Groove Dimensions

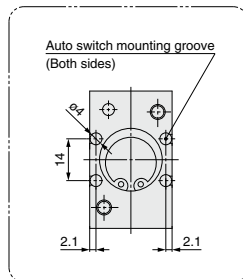

* The dimensions of the heat resistance or fluororubber seal types are the same as those shown above.

- MHZ
- MHF
- MHL
- MHR
- MHK
- MHS
- MHC
- MHT
- MHY
- MHW
- X□
- MRHQ
- MA
- D-□

Parallel Type Air Gripper with Dust Cover

MHZJ2 Series

ø6, ø10, ø16, ø20, ø25, ø32, ø40

How to Order

MHZJ2-16 D □ □ -M9BW □ - □

Number of fingers

| | |
|---|-----------|
| 2 | 2 fingers |
|---|-----------|

Bore size

| | |
|----|-------|
| 6 | 6 mm |
| 10 | 10 mm |
| 16 | 16 mm |
| 20 | 20 mm |
| 25 | 25 mm |

Action

| | |
|---|---------------------------------|
| D | Double acting |
| S | Single acting (Normally open) |
| C | Single acting (Normally closed) |

Body option

* ø32, ø40: Made to Order (For details, refer to page 451.) * ø6 is only applicable with basic type.

Made to Order
Refer to page 441 for details.

Number of auto switches

| | |
|-----|--------|
| Nil | 2 pcs. |
| S | 1 pc. |
| n | n pc. |

Auto switch

| | |
|-----|---------------------------------------|
| Nil | Without auto switch (Built-in magnet) |
|-----|---------------------------------------|

* For the applicable auto switch model, refer to the table below.

Dust cover type

| | |
|-----|-------------------------|
| Nil | Chloroprene rubber (CR) |
| F | Fluororubber (FKM) |
| S | Silicone rubber (Si) |

Nil: Basic type

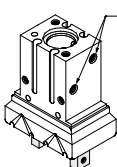

E: End boss type Side ported (Double acting /Single acting)

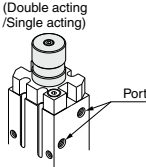

W: End boss type Axial ported with ø4 One-touch fitting for coaxial tubing (Double acting)

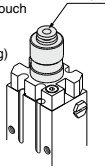

K: End boss type Axial ported with ø4 One-touch fitting for coaxial tubing (Single acting)

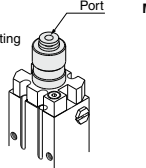

M: End boss type Axial ported with M5 port (Single acting)

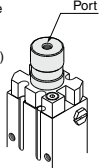

Applicable Auto Switches

Refer to pages 797 to 850 for further information on the auto switch.

| Type | Special function | Electrical entry | Indicator light | Wiring (Output) | Load voltage | | Auto switch model | | Lead wire length (m) * | | | | | Applicable model | | | | | Pre-wired connector | Applicable load |
|-------------------------|-------------------------------|------------------|-----------------|-----------------|--------------|--------|----------------------------|---------|------------------------|-------|-------|-------|----|------------------|-----|------------|------------|------------|---------------------|-----------------|
| | | | | | DC | AC | Electrical entry direction | | 0.5 (Nil) | 1 (M) | 3 (L) | 5 (Z) | ø6 | ø10 | ø16 | ø20 | ø25 | | | |
| | | | | | | | Perpendicular | In-line | | | | | | | | | | | | |
| Solid state auto switch | — | Grommet | Yes | 3-wire (NPN) | 5 V, 12 V | — | M9NV | M9N | ● | ● | ○ | ● | ● | ● | ● | ● | ○ | IC circuit | Relay, PLC | |
| | | | | | | | F8N | — | ● | — | ○ | ● | — | ● | ● | ● | ○ | | | |
| | | | | 3-wire (PNP) | M9PV | M9P | ● | ● | ○ | ● | ● | ● | ● | ● | ○ | — | | | | |
| | | | | | F8P | — | ● | — | ○ | ● | — | ● | ● | ● | — | — | | | | |
| | | | | 2-wire | M9BV | M9B | ● | ● | ○ | ● | ● | ● | ● | ● | ○ | — | | | | |
| | | | | | F8B | — | ● | — | ○ | ● | — | ● | ● | ● | — | — | | | | |
| | Diagnosis (2-color indicator) | Grommet | Yes | 3-wire (NPN) | 5 V, 12 V | — | M9NVV | M9NW | ● | ● | ○ | ● | ● | ● | ● | ○ | IC circuit | Relay, PLC | | |
| | | | | | | | M9PWW | M9PW | ● | ● | ○ | ● | ● | ● | ● | ○ | | | | |
| | | | | 3-wire (PNP) | M9BWW | M9BW | ● | ● | ○ | ● | ● | ● | ● | ● | ○ | — | | | | |
| | | | | | M9NAV** | M9NA** | ○ | ○ | ○ | ○ | ● | ● | ● | ● | ○ | IC circuit | | | | |
| | | | | 2-wire | M9PAV** | M9PA** | ○ | ○ | ○ | ○ | ● | ● | ● | ● | ○ | | | | — | |
| | | | | | M9BAV** | M9BA** | ○ | ○ | ○ | ○ | ● | ● | ● | ● | ○ | — | | | | |

** Water resistant type auto switches can be mounted on the above models, but in such case SMC cannot guarantee water resistance.

* Lead wire length symbols: 0.5 m..... Nil (Example) M9NW

* Solid state auto switches marked with ○ are produced upon receipt of order.

1 m..... M (Example) M9NWM

3 m..... L (Example) M9NWL

5 m..... Z (Example) M9NWZ

Note 1) When using the 2-color indicator type, please make the setting so that the indicator is lit in red to ensure the detection at the proper position of the air gripper.

Note 2) When using a D-F8□ switch on sizes ø6, mount it at a distance of 10 mm or more from magnetic substances such as iron, etc.



Symbol

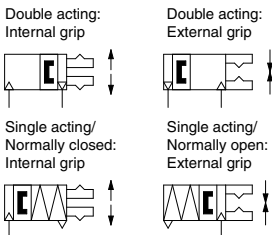

Made to Order Individual Specifications
(Refer to pages 451 to 453 for details.)

| Symbol | Specifications/Description |
|--------|----------------------------|
| -X6100 | With dust cover (ø32, ø40) |

Made to Order

[Click here for details](#)

| Symbol | Specifications/Description |
|--------|--|
| -X4 | Heat resistance (100°C) |
| -X5 | Fluororubber seal |
| -X7 | Closing direction spring assist |
| -X12 | Opening direction spring assist |
| -X50 | Without magnet |
| -X53 | EPDM seal/Fluorine grease |
| -X56 | Axial ported type |
| -X63 | Fluorine grease |
| -X64 | Finger: Side tapped mounting |
| -X65 | Finger: Through-hole mounting |
| -X77A | Dust cover adhesion |
| -X77B | Dust cover adhesion (Finger part only) |
| -X78A | Dust cover caulking |
| -X78B | Dust cover caulking (Finger part only) |
| -X79 | Grease for food processing machines, Fluorine grease |
| -X79A | Grease for food processing machines |
| -X81A | Anti-corrosive treatment of finger |

Moisture Control Tube IDK Series



When operating an actuator with a small diameter and a short stroke at a high frequency, the dew condensation (water droplet) may occur inside the piping depending on the conditions.

Simply connecting the moisture control tube to the actuator will prevent dew condensation from occurring. For details, refer to [the IDK series in the Best Pneumatics No. 6](#).

Specifications

| | | Fluid | Air |
|--|---------------|--|---------------------|
| Operating pressure | Double acting | Normally open | ø6: 0.15 to 0.7 MPa |
| | | | ø10: 0.2 to 0.7 MPa |
| | Single acting | Normally closed | ø6: 0.3 to 0.7 MPa |
| | | ø10: 0.35 to 0.7 MPa | |
| Ambient and fluid temperature | | -10 to 60°C | |
| Repeatability | | ±0.01 mm | |
| Max. operating frequency | | 180 c.p.m. | |
| Lubrication | | Not required | |
| Action | | Double acting, Single acting | |
| Auto switch (option) ^(Note) | | Solid state auto switch (3-wire, 2-wire) | |

(Note) Refer to pages 797 to 850 for further information on auto switches.

Model

| Action | Model | Bore size (mm) | Gripping force ^(Note 1) | | Opening/Closing stroke (Both sides) (mm) | Weight ^(Note 2) (g) | |
|---------------|-----------------|----------------|---|----------|--|--------------------------------|-----|
| | | | Gripping force per finger Effective value (N) | | | | |
| | | | External | Internal | | | |
| Double acting | MHZJ2-6D | 6 | 3.3 | 6.1 | 4 | 28 | |
| | MHZJ2-10D | 10 | 9.8 | 17 | 4 | 60 | |
| | MHZJ2-16D | 16 | 30 | 40 | 6 | 130 | |
| | MHZJ2-20D | 20 | 42 | 66 | 10 | 250 | |
| | MHZJ2-25D | 25 | 65 | 104 | 14 | 460 | |
| Single acting | Normally closed | MHZJ2-6S | 6 | 1.9 | — | 4 | 28 |
| | | MHZJ2-10S | 10 | 6.3 | — | 4 | 60 |
| | | MHZJ2-16S | 16 | 24 | — | 6 | 130 |
| | | MHZJ2-20S | 20 | 28 | — | 10 | 255 |
| | | MHZJ2-25S | 25 | 45 | — | 14 | 465 |
| | Normally open | MHZJ2-6C | 6 | — | 3.7 | 4 | 28 |
| | | MHZJ2-10C | 10 | — | 12 | 4 | 60 |
| | | MHZJ2-16C | 16 | — | 31 | 6 | 130 |
| | | MHZJ2-20C | 20 | — | 56 | 10 | 255 |
| MHZJ2-25C | 25 | — | 83 | 14 | 465 | | |

Note 1) Values based on pressure of 0.5 MPa, gripping point L = 20 mm, at center of stroke.

Note 2) Values excluding weight of auto switch.

Option

● Body Option/End Boss Type

| Symbol | Piping port location | Type of piping port | | | | Applicable model | |
|--------|----------------------|--|----------|----------|----------|------------------|---------------|
| | | MHZJ2-10 | MHZJ2-16 | MHZJ2-20 | MHZJ2-25 | Double acting | Single acting |
| Nil | Basic type | M3 x 0.5 | M5 x 0.8 | | ● | ● | |
| E | Side ported | M3 x 0.5 | M5 x 0.8 | | ● | ● | |
| W | Axial ported | With ø4 One-touch fitting for coaxial tubing | | | | ● | — |
| K | Axial ported | With ø4 One-touch fitting | | | | — | ● |
| M | Axial ported | M5 x 0.8 | | | | — | ● |

* For detailed body option specifications, refer to option specifications on pages 449 and 450.

Refer to pages 454 to 458 for the specifications with auto switch.

- Auto switch installation examples and mounting positions
- Auto switch hysteresis
- Auto switch mounting
- Protrusion of auto switch from edge of body

MHZJ2 Series

Construction: MHZJ2-6□

Double acting/With fingers open

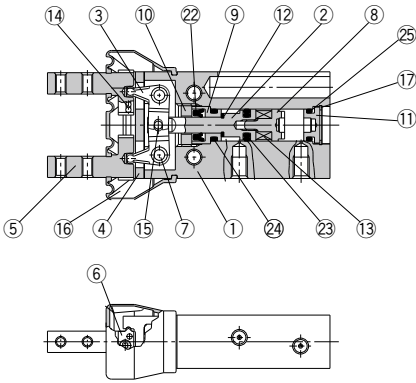

Double acting/With fingers closed

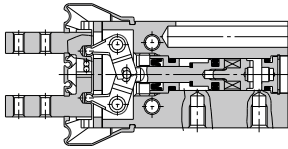

Single acting/Normally open

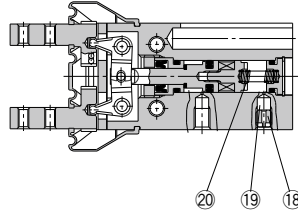

Single acting/Normally closed

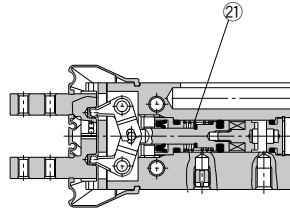

Component Parts

| No. | Description | Material | Note |
|-----|-----------------------|----------------------------------|---------------------------|
| 1 | Body | Aluminum alloy | Hard anodized |
| 2 | Piston | Stainless steel | |
| 3 | Lever | Stainless steel | Heat treated |
| 4 | Guide | Stainless steel | Heat treated |
| 5 | Finger | Stainless steel | Heat treated |
| 6 | Roller stopper | Stainless steel | |
| 7 | Lever shaft | Stainless steel | Nitriding |
| 8 | Magnet holder | Stainless steel | |
| 9 | Holder | Brass | Electroless nickel plated |
| 10 | Holder lock | Stainless steel | |
| 11 | Cap | Aluminum alloy | Clear anodized |
| 12 | Bumper | Urethane rubber | |
| 13 | Magnet | — | Nickel plated |
| 14 | Steel balls | High carbon chrome bearing steel | |
| 15 | Needle roller | High carbon chrome bearing steel | |
| 16 | Dust cover | CR | Chloroprene rubber |
| | | FKM | Fluororubber |
| | | Silicone rubber | |
| 17 | Type C retaining ring | Carbon steel | Nickel plated |
| 18 | Exhaust plug | Brass | Electroless nickel plated |
| 19 | Exhaust filter | Polyvinyl formal | |
| 20 | N.O. spring | Stainless steel spring wire | |
| 21 | N.C. spring | Stainless steel spring wire | |
| 22 | Rod seal | NBR | |
| 23 | Piston seal | NBR | |
| 24 | Gasket | NBR | |
| 25 | Gasket | NBR | |

Replacement Parts

| Description | | MHZJ2-6 | Main parts |
|-----------------|----------|--|---|
| Seal kit | | Please contact SMC to replace the seal kit. | |
| Dust cover | Material | CR | MHZJ2-J6 |
| | | FKM | MHZJ2-J6F |
| | | Silicone rubber | MHZJ2-J6S |
| Finger assembly | | Please contact SMC to replace the finger assembly. | |
| Piston assembly | | MHZJ2-6D□ | MHZJ-A0603 |
| | | MHZJ2-6S□ | |
| | | MHZJ2-6C□ | |
| | | | ② ⑧ ⑨ ⑩ ⑫ ⑬ ⑮ ⑰ ⑲ ⑳ ㉑ ㉒ ㉓ ㉔ |
| | | | ㉕ ㉖ ㉗ ㉘ ㉙ ㉚ ㉛ ㉜ ㉝ ㉞ ㉟ ㊱ ㊲ ㊳ ㊴ ㊵ ㊶ ㊷ ㊸ ㊹ ㊺ |

Replacement part/Grease pack part no.: GR-S-010 (5 g)

Construction: MHZJ2-10□ to 25□

Double acting/With fingers open

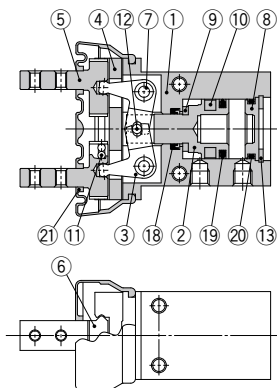

Single acting/Normally open

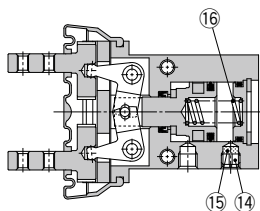

Double acting/With fingers closed

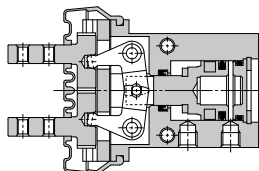

Single acting/Normally closed

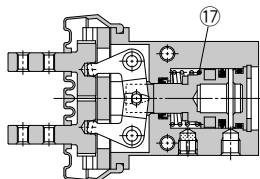

Component Parts

| No. | Description | Material | Note |
|-----|----------------|---|----------------|
| 1 | Body | Aluminum alloy | Hard anodized |
| 2 | Piston | ø10, ø16: Stainless steel ø20, ø25: Aluminum alloy | Hard anodized |
| 3 | Lever | Stainless steel | Nitriding |
| 4 | Guide | Stainless steel | Heat treated |
| 5 | Finger | Stainless steel | Heat treated |
| 6 | Roller stopper | Stainless steel | |
| 7 | Lever shaft | Stainless steel | Nitriding |
| 8 | Cap | Aluminum alloy | Clear anodized |
| 9 | Bumper | Urethane rubber | |
| 10 | Rubber magnet | Synthetic rubber | |
| 11 | Steel balls | High carbon chrome bearing steel | |

| No. | Description | Material | Note |
|-----|-----------------------|----------------------------------|---------------------------|
| 12 | Needle roller | High carbon chrome bearing steel | |
| 13 | Type C retaining ring | Carbon steel | Nickel plated |
| 14 | Exhaust plug A | Brass | Electroless nickel plated |
| 15 | Exhaust filter A | Polyvinyl formal | |
| 16 | N.O. spring | Stainless steel spring wire | |
| 17 | N.O. spring | Stainless steel spring wire | |
| 18 | Rod seal | NBR | |
| 19 | Piston seal | NBR | |
| 20 | Gasket | NBR | |
| 21 | Dust cover | CR | Chloroprene rubber |
| | | FKM | Fluororubber |
| | | Silicone rubber | |

Replacement Parts

| Description | | MHZJ2-10 | MHZJ2-16 | MHZJ2-20 | MHZJ2-25 | Main parts |
|--------------------------|-----------------|-------------|-------------|-------------|-------------|--|
| Seal kit | | MHZJ10-PS | MHZJ16-PS | MHZJ20-PS | MHZJ25-PS | ⑱⑲⑳ |
| Dust cover | Material | | | | | |
| | CR | MHZJ2-J10 | MHZJ2-J16 | MHZJ2-J20 | MHZJ2-J25 | |
| | FKM | MHZJ2-J10F | MHZJ2-J16F | MHZJ2-J20F | MHZJ2-J25F | ㉑ |
| | Silicone rubber | MHZJ2-J10S | MHZJ2-J16S | MHZJ2-J20S | MHZJ2-J25S | ㉒⑨⑩⑬ |
| Finger assembly | | MHZJ-AA1002 | MHZJ-AA1602 | MHZJ-AA2002 | MHZJ-AA2502 | ④⑤⑥⑪ Mounting thread |
| Piston assembly | | MHZJ-A1003 | MHZJ-A1603 | MHZJ-A2003 | MHZJ-A2503 | ②⑨⑩⑬ |
| End boss assembly | MHZJ2-□□□□W | MHZ-A1007 | MHZ-A1607 | MHZ-A2007 | MHZ-A2507 | Main body of adaptor Mounting screw for adaptor Seal kit |
| | MHZJ2-□□□□K | MHZ-A1008 | MHZ-A1608 | MHZ-A2008 | MHZ-A2508 | |
| | MHZJ2-□□□□M | MHZ-A1009 | MHZ-A1609 | MHZ-A2009 | MHZ-A2509 | |
| | MHZJ2-□□□□E | MHZ-A1010 | MHZ-A1610 | MHZ-A2010 | MHZ-A2510 | |
| Lever assembly | | MHZJ-A1004 | MHZJ-A1604 | MHZJ-A2004 | MHZJ-A2504 | ③⑦ |

* Material of packing
NBR = Nitrile rubber, FKM = Fluororubber

* Material of dust cover

CR = Chloroprene rubber, FKM = Fluororubber, Silicone rubber

* End boss type

W = One-touch fitting for coaxial tubing, K = With One-touch fitting, M = With M5 port, E = Side ported

* The end boss assembly other than type E should be mounted on the special body.

Replacement part/Grease pack part no.: GR-S-010 (10 g)

MHZ

MHF

MHL

MHR

MHK

MHS

MHC

MHT

MHY

MHW

-X□

MRHQ

MA

D-□

MHZJ2 Series

Dimensions

MHZJ2-6□ Double acting/Single acting Basic type

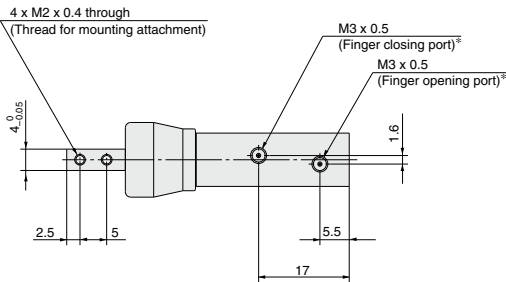
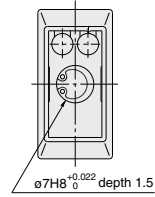
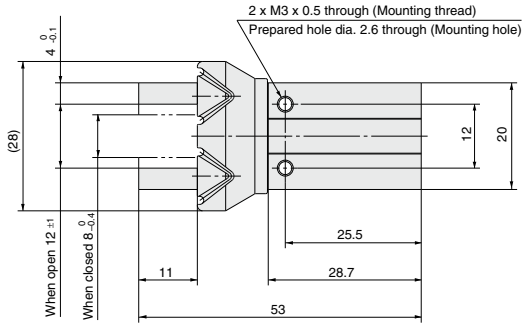
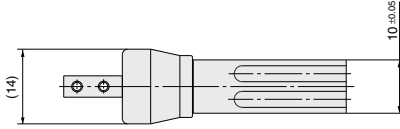

* For single action, the port on one side is a breathing hole.

Auto Switch Mounting Groove Dimensions

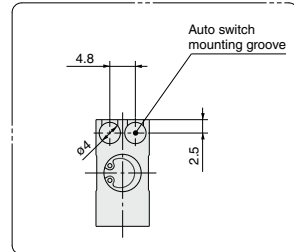

MHZJ2-10□ Double acting/Single acting
Basic type

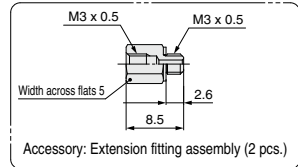
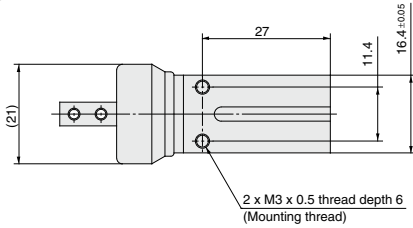

Note) If the fitting attached to the port interferes with the auto switch, please use the extension fitting assembly supplied with the air gripper.

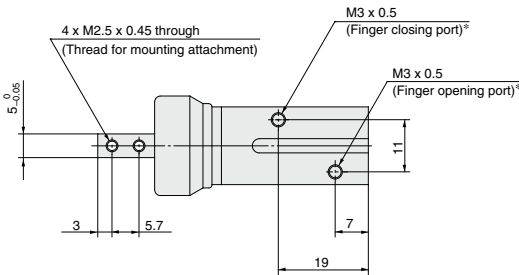
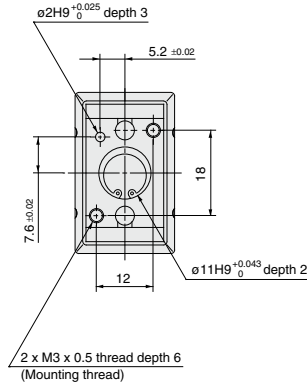
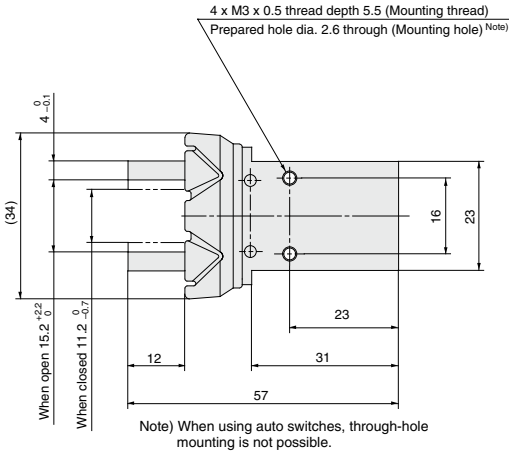

* For single action, the port on one side is a breathing hole.

Auto Switch Mounting Groove Dimensions

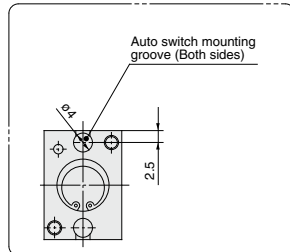

Note) When using auto switches, through-hole mounting is not possible.

- MHZ
- MHF
- MHL
- MHR
- MHK
- MHS
- MHC
- MHT
- MHY
- MHW
- X□
- MRHQ
- MA
- D-□

MHZJ2-20 □ Double acting/Single acting
Basic type

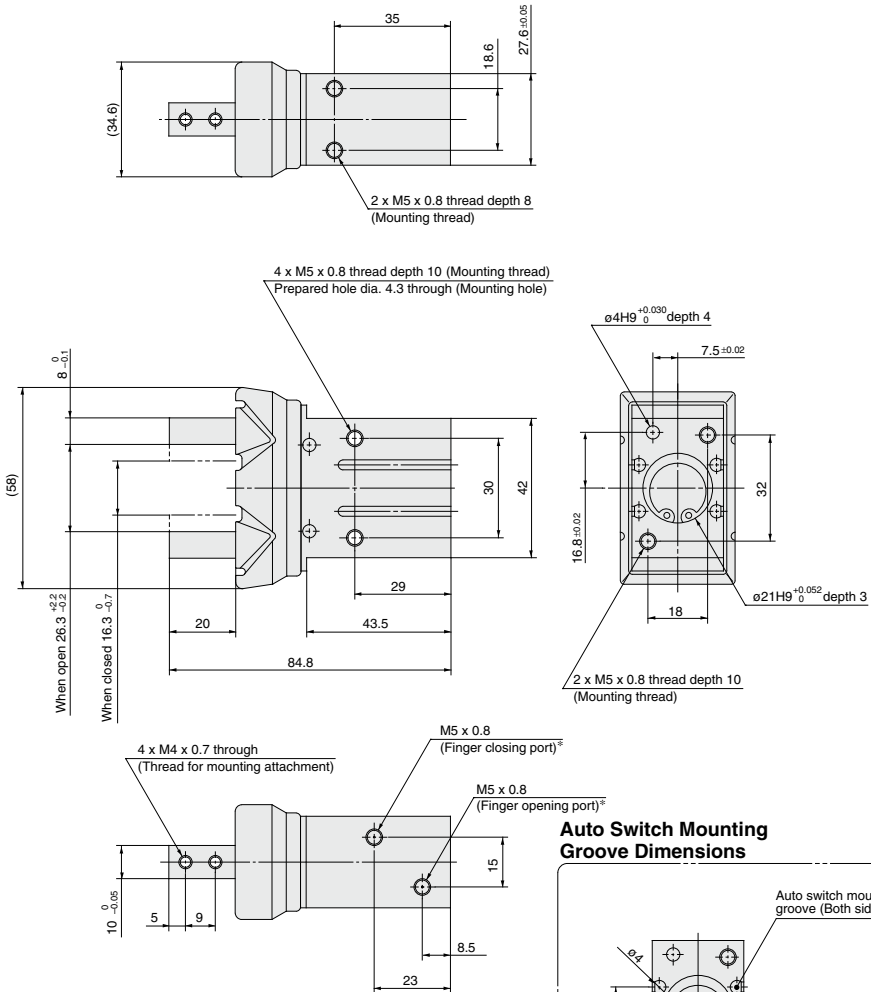

* For single action, the port on one side is a breathing hole.

| |
|------|
| MHZ |
| MHF |
| MHL |
| MHR |
| MHK |
| MHS |
| MHC |
| MHT |
| MHY |
| MHW |
| -X □ |
| MRHQ |
| MA |
| D- □ |

MHZJ2 Series

Dimensions

MHZJ2-25 □ Double acting/Single acting

Basic type

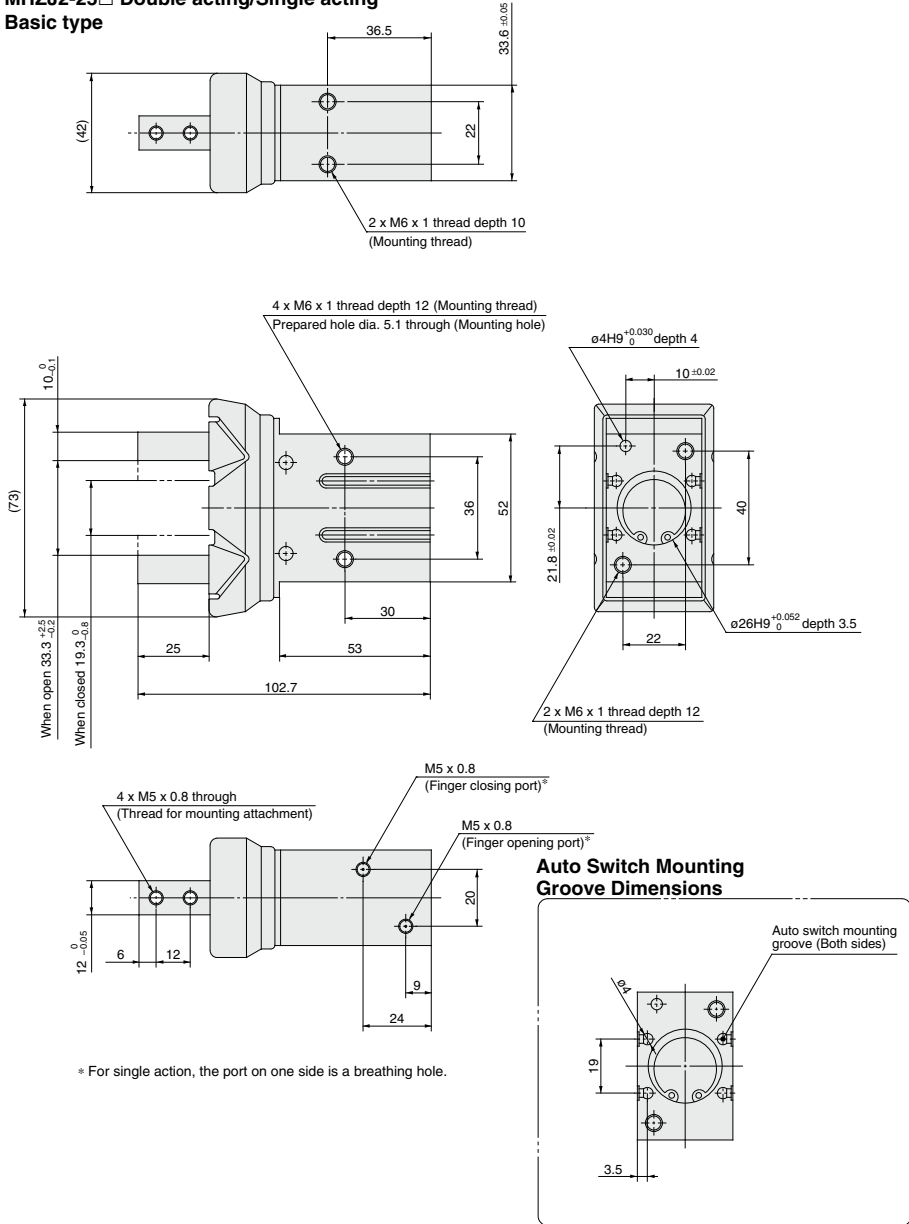

* For single action, the port on one side is a breathing hole.

With Dust Cover/MHZJ2 Series Body Option: End Boss Type

Applicable Model

| Symbol | Piping port location | Type of piping port | | | | Applicable model | | |
|--------|----------------------|--|----------|----------|----------|------------------|---------------|-----------------|
| | | MHZJ2-10 | MHZJ2-16 | MHZJ2-20 | MHZJ2-25 | Double acting | Single acting | |
| | | With $\phi 4$ One-touch fitting for coaxial tubing | | | | | Normally open | Normally closed |
| E | Side ported | M3 x 0.5 | M5 x 0.8 | | | ● | ● | ● |
| W | Axial ported | With $\phi 4$ One-touch fitting | | | | — | — | — |
| K | | With $\phi 4$ One-touch fitting | | | | — | ● | ● |
| M | | M5 x 0.8 | | | | — | ● | ● |

Side Ported [E]

Auto switch mounting groove (4 locations) (Except $\phi 10$)

Auto switch mounting groove (Both sides) ($\phi 10$ only: Round groove)

| Model | A | B | D1 | D2 | E |
|-------------|----|----|--|----|------|
| MHZJ2-10□□E | 15 | 7 | 12f8 ^{-0.016} _{-0.043} | 11 | 40 |
| MHZJ2-16□□E | 20 | 10 | 16f8 ^{-0.016} _{-0.043} | 15 | 43.5 |
| MHZJ2-20□□E | 22 | 12 | 20f8 ^{-0.020} _{-0.053} | 19 | 51.7 |
| MHZJ2-25□□E | 25 | 15 | 25f8 ^{-0.020} _{-0.053} | 24 | 61.3 |

Other dimensions and specifications correspond to the standard type.

(mm)

* Refer to the dimension table.
* When auto switches are used on $\phi 10$, side mounting with through-holes is not possible.

Axial Ported (with One-touch fitting for coaxial tubing) [W]

Plug $\phi 10$:
 $\phi 16$ to 25: M-5P

Applicable coaxial tubing

Auto switch mounting groove (4 locations) (Except $\phi 10$)

Auto switch mounting groove (Both sides) ($\phi 10$ only: Round groove)

| Model | A | B | D1 | D2 | E | F | G | H |
|-------------|----|----|--|----|------|------|------|-----|
| MHZJ2-10D□W | 15 | 7 | 12f8 ^{-0.016} _{-0.043} | 11 | 40 | 16 | 28 | 5.5 |
| MHZJ2-16D□W | 20 | 10 | 16f8 ^{-0.016} _{-0.043} | 15 | 43.5 | 16.2 | 27.7 | 6.5 |
| MHZJ2-20D□W | 22 | 12 | 20f8 ^{-0.020} _{-0.053} | 19 | 51.7 | 16.7 | 31.2 | 7.5 |
| MHZJ2-25D□W | 25 | 15 | 25f8 ^{-0.020} _{-0.053} | 24 | 61.3 | 17.3 | 32.3 | 10 |

Other dimensions and specifications correspond to the standard type.

Applicable Coaxial Tubing

| Model | TW04B-20 |
|-------------------------|-------------|
| Specifications | |
| Outside diameter | 4 mm |
| Max. operating pressure | 0.6 MPa |
| Min. bending radius | 10 mm |
| Operating temperature | -20 to 60°C |
| Material | Nylon 12 |

Reference symbol

External passage
Internal passage

(mm)

* Refer to the dimension table.
* When auto switches are used on $\phi 10$, side mounting with through-holes is not possible.

Changing from Coaxial to Single Tubing

Changing to single tubing is possible by using a branch "Y" or branch tee fitting. In this case particularly, single tube fittings and tubing for $\phi 3.2$ will be necessary.

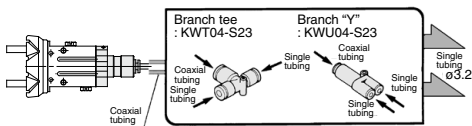

Branch Tee, Different Diameter Tee, Branch "Y", Male Run Tee

Please contact your SMC sales representative for details of the coaxial fittings and tubing.

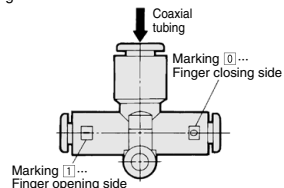

MHZJ2 Series

Axial Ported (with One-touch fitting) [K]

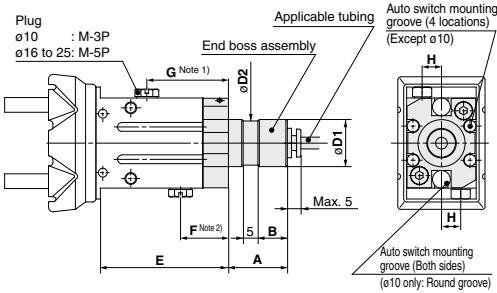

- * Refer to the dimension table.
- * When auto switches are used on $\phi 10$, side mounting with through-holes is not possible.

Note 1) Normally open type plug position.
 Note 2) Normally closed type plug position.
 The plug is mounted on only one side for the single acting type.

| Model | A | B | D1 | D2 | E | F | G | H |
|---------------------------|----|----|--|----|------|------|------|-----|
| MHZJ2-10 ^S C□K | 15 | 7 | 12f8 ^{-0.016} _{-0.043} | 11 | 40 | 16 | 28 | 5.5 |
| MHZJ2-16 ^S C□K | 20 | 10 | 16f8 ^{-0.016} _{-0.043} | 15 | 43.5 | 16.2 | 27.7 | 6.5 |
| MHZJ2-20 ^S C□K | 22 | 12 | 20f8 ^{-0.020} _{-0.053} | 19 | 51.7 | 16.7 | 31.2 | 7.5 |
| MHZJ2-25 ^S C□K | 25 | 15 | 25f8 ^{-0.020} _{-0.053} | 24 | 61.3 | 17.3 | 32.3 | 10 |

Other dimensions and specifications correspond to the standard type.

Applicable Tubing

| Description/Model | Nylon tubing | Soft nylon tubing | Polyurethane tubing | Polyurethane coil tubing |
|-------------------------------|--------------|-------------------|---------------------|--------------------------|
| | T0425 | TS0425 | TU0425 | TCU0425B-1 |
| Outside diameter (mm) | 4 | 4 | 4 | 4 |
| Max. operating pressure (MPa) | 1.0 | 0.8 | 0.5 | 0.5 |
| Min. bending radius (mm) | 13 | 12 | 10 | — |
| Operating temperature (°C) | -20 to 60 | -20 to 60 | -20 to 60 | -20 to 60 |
| Material | Nylon 12 | Nylon 12 | Polyurethane | Polyurethane |

Refer to "Pneumatic Piping Equipment (CAT. E50)" regarding One-touch fittings and tubing.

Axial Ported (with M5 port) [M]

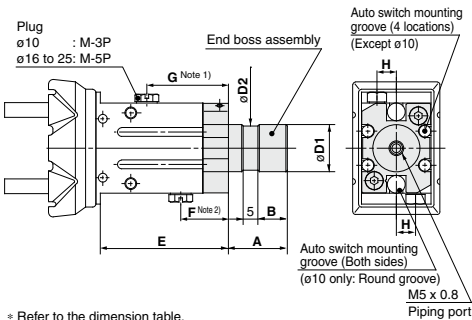

- * Refer to the dimension table.
- * When auto switches are used on $\phi 10$, side mounting with through-holes is not possible.

Note 1) Normally open type plug position.
 Note 2) Normally closed type plug position.
 The plug is mounted on only one side for the single acting type.

| Model | A | B | D1 | D2 | E | F | G | H |
|---------------------------|----|----|--|----|------|------|------|-----|
| MHZJ2-10 ^S C□M | 15 | 7 | 12f8 ^{-0.016} _{-0.043} | 11 | 40 | 16 | 28 | 5.5 |
| MHZJ2-16 ^S C□M | 20 | 10 | 16f8 ^{-0.016} _{-0.043} | 15 | 43.5 | 16.2 | 27.7 | 6.5 |
| MHZJ2-20 ^S C□M | 22 | 12 | 20f8 ^{-0.020} _{-0.053} | 19 | 51.7 | 16.7 | 31.2 | 7.5 |
| MHZJ2-25 ^S C□M | 25 | 15 | 25f8 ^{-0.020} _{-0.053} | 24 | 61.3 | 17.3 | 32.3 | 10 |

Other dimensions and specifications correspond to the standard type.

Weight

| Model | End boss type (Symbol) | | | |
|------------|------------------------|-----|-----|-----|
| | E | W | K | M |
| MHZJ2-10□□ | 70 | 70 | 70 | 70 |
| MHZJ2-16□□ | 165 | 165 | 165 | 165 |
| MHZJ2-20□□ | 290 | 290 | 290 | 290 |
| MHZJ2-25□□ | 525 | 525 | 525 | 525 |

MHZJ2 Series

Made to Order Individual Specifications

Please contact SMC for detailed dimensions, specifications and lead times.



1 With dust cover (For MHZJ 32, 40)

Symbol
-X6100

With dust cover type (size 32, 40)

MHZJ2 - 32 D - M9BW - X6100

Number of fingers
2 2 fingers

Bore size
32 32 mm
40 40 mm

Action
D Double acting

Dust cover type
Nil Chloroprene rubber (CR)
F Fluororubber (FKM)
S Silicone rubber

Auto switch
Nil Without auto switch (Built-in magnet)

* Available only for D-M9□.

With dust cover
Number of auto switches

| | |
|-----|--------|
| Nil | 2 pcs. |
| S | 1 pc. |
| n | n pc. |

Special specifications

| Symbol | Basic type | Dust cover type | | |
|--------|-------------------|------------------------------|-----------------------|--------------------|
| | | Nil: Chloroprene rubber (CR) | F: Fluororubber (FKM) | S: Silicone rubber |
| Nil | Basic type | ○ | ○ | ○ |
| A | Heat resistance | — | ○ | ○ |
| B | Fluororubber seal | — | ○ | — |

* When using the heat resistance or fluororubber seal types, refer to "Precautions" shown below.

Specifications

| Model | | Basic type | Heat resistance | Fluororubber seal |
|-------------------------------|---------------|----------------|-----------------|-------------------|
| Fluid | | Air | | |
| Operating pressure | Double acting | 0.1 to 0.7 MPa | | |
| Ambient and fluid temperature | | -10 to 60°C | -10 to 100°C | -10 to 60°C |
| Repeatability | | ±0.01 mm | | |
| Max. operating frequency | | 60 c.P/m | | |
| Lubrication | | Not required | | |
| Action | | Double acting | | |

Model

| Action | Model | Bore size (mm) | Gripping force ^{Note 1)} | | Opening/Closing stroke (Both sides) (mm) | Weight ^{Note 2)} (g) |
|---------------|------------------|----------------|---|----------|--|-------------------------------|
| | | | Gripping force per finger Effective value (N) | | | |
| | | | External | Internal | | |
| Double acting | MHZJ2-32D-X6100□ | 32 | 158 | 193 | 22 | 760 |
| | MHZJ2-40D-X6100□ | 40 | 254 | 318 | 30 | 1325 |

Note 1) Values based on pressure of 0.5 MPa, gripping point L = 20 mm, at center of stroke.

Note 2) Values excluding weight of auto switch.

Handling Precautions

Heat resistance

Warning

Be aware that smoking cigarettes after your hands have come into contact with the grease used for this air gripper can create a gas that is hazardous to humans.

Caution

- Note 1) Magnet is built-in, but when using an auto switch, the acceptable temperature range becomes -10 to 60°C.
- Note 2) With the part number for the dust cover option, only fluororubber (F) or silicone rubber (S) options may be selected.
- Note 3) For lubrication, specialized grease GR-F is recommended.

Fluororubber seal

Caution

- Note 1) Please contact SMC, since the type of chemical and the operating temperature may not allow the use of this product.
- Note 2) Since the standard-type magnet is built-in, please contact SMC for the product's adaptability to the operating environment.
- Note 3) For the air gripper with a dust cover, the dust cover material is also fluororubber. Thus, enter (F) for the fluororubber dust cover in the part number.

MHZ

MHF

MHL

MHR

MHK

MHS

MHC

MHT

MHY

MHW

-X□

MHQ

MA

D-□

MHZJ2 Series

Dimensions (Dimensions other than specified below are the same as the standard type.)

MHZJ2-32D□-X6100

Basic type/Double acting

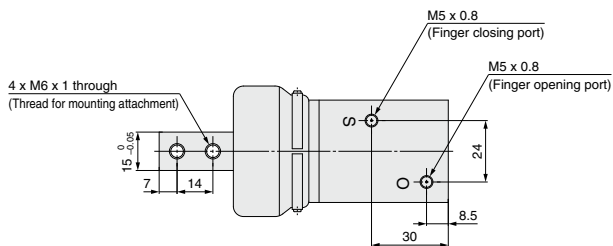
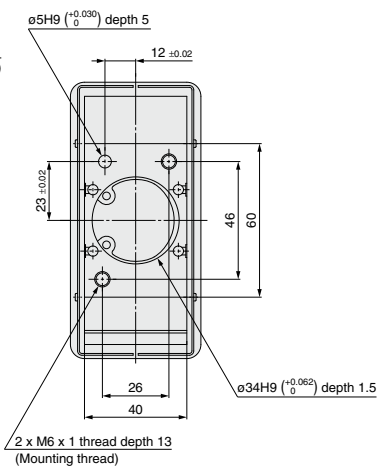
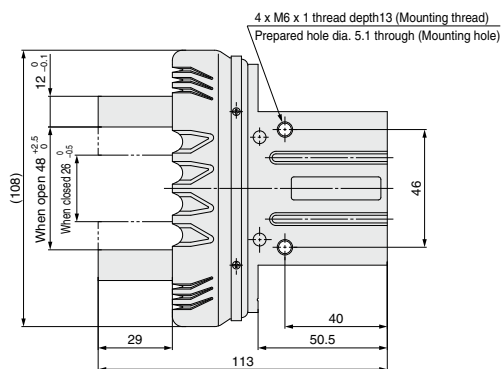
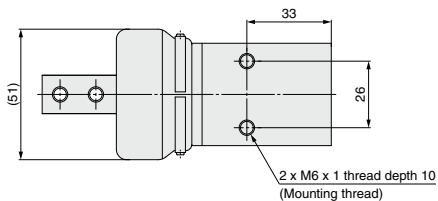

Auto switch mounting groove

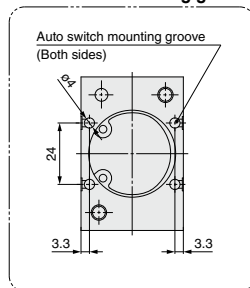

* The dimensions of the heat resistance or fluororubber seal types are the same as those shown above.

Dimensions (Dimensions other than specified below are the same as the standard type.)

MHZJ2-40D□-X6100
Basic type/Double acting

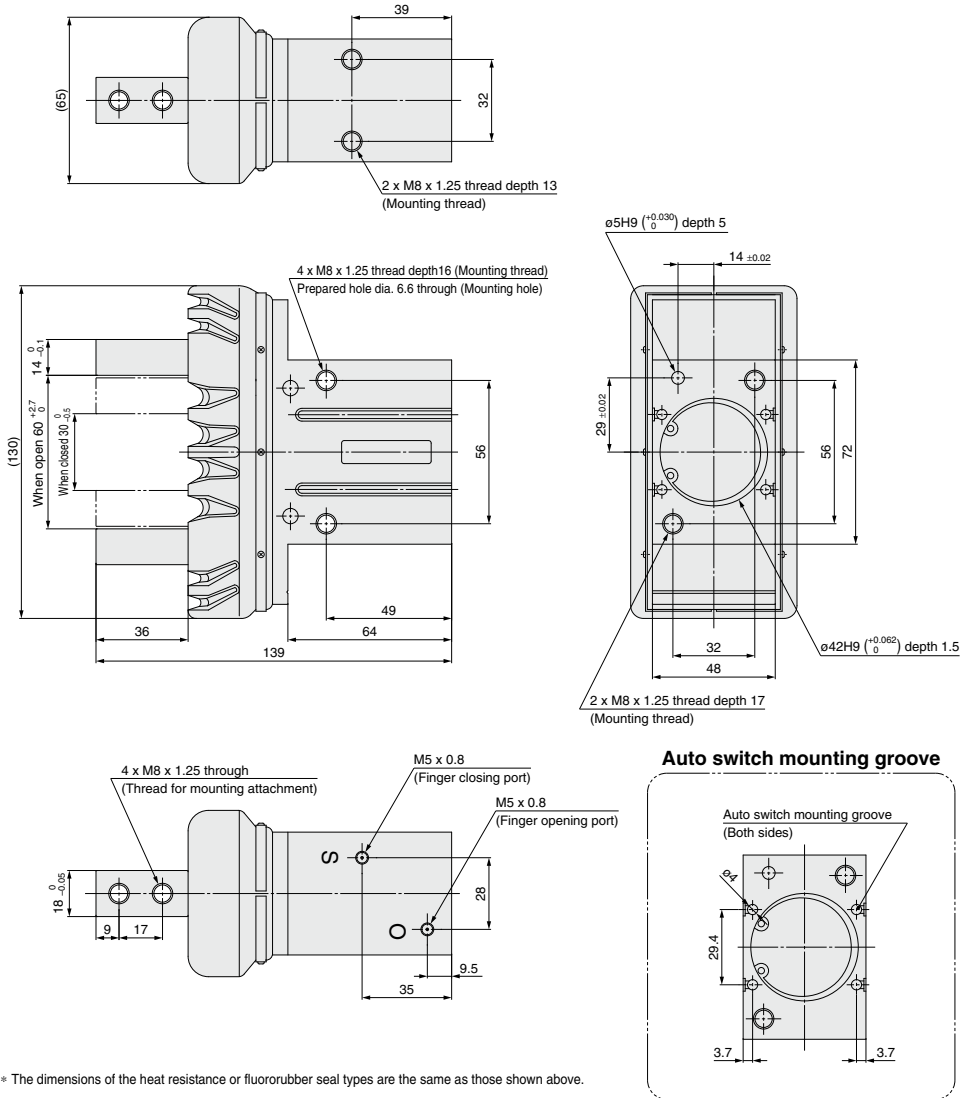

* The dimensions of the heat resistance or fluororubber seal types are the same as those shown above.



- MHZ
- MHF
- MHL
- MHR
- MHK
- MHS
- MHC
- MHT
- MHY
- MHW
- X□
- MRHQ
- MA
- D-□

MHZ2/MHZ□2 Series

Auto Switch Installation Examples and Mounting Position

Various auto switch applications are possible through different combinations of auto switch quantities and detecting positions.

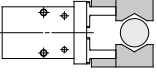
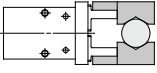
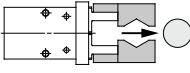
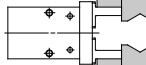
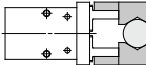
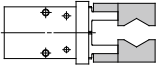
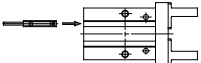
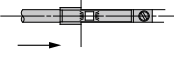
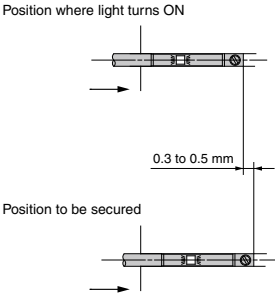
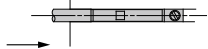
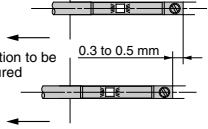
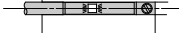
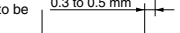
1) Detection when Gripping Exterior of Workpiece

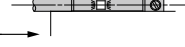



| Detection example | | 1. Confirmation of fingers in reset position | 2. Confirmation of workpiece held | 3. Confirmation of workpiece released |
|---|---|---|---|---------------------------------------|
| Position to be detected | Position of fingers fully opened  | Position when gripping workpiece  | Position of fingers fully closed  | |
| Operation of auto switch | Auto switch turned on when fingers return. (Light ON) | Auto switch turned on when gripping a workpiece. (Light ON) | When a workpiece is not held (Abnormal operation): Auto switch to turn ON (Light ON) | |
| Detection combinations | One auto switch *One position, any of ①, ②, and ③ can be detected. | ● | ● | ● |
| | Two auto switches *Two positions of ①, ②, and ③ can be detected. | Pattern A | ● | — |
| | | Pattern B | — | ● |
| Pattern C | ● | — | ● | |
| How to determine auto switch installation position | Step 1) Fully open the fingers.  | Step 1) Position fingers for gripping a workpiece.  | Step 1) Fully close the fingers.  | |
| At no pressure or low pressure, connect the auto switch to a power supply, and follow the directions. | Step 2) Insert the auto switch into the switch installation groove in the direction shown in the following drawing.  | | | |
| | Step 3) Slide the auto switch in the direction of the arrow until the indicator light illuminates.  | Step 3) Slide the auto switch in the direction of the arrow until the light illuminates and fasten it at a position 0.3 to 0.5 mm in the direction of the arrow beyond the position where the indicator light illuminates.  | | |
| | Step 4) Slide the auto switch further in the direction of the arrow until the indicator light goes out.  | | | |
| | Step 5) Move the auto switch in the opposite direction and fasten it at a position 0.3 to 0.5 mm beyond the position where the indicator light illuminates.  | | | |
| | Position where light turns ON  Position to be secured 0.3 to 0.5 mm  | Position where light turns ON  Position to be secured 0.3 to 0.5 mm  | | |

Note 1) It is recommended that gripping of a workpiece be performed close to the center of the finger stroke.

Note 2) When holding a workpiece close at the end of open/close stroke of fingers, detecting performance of the combinations listed in the above table may be limited, depending on the hysteresis of an auto switch, etc.

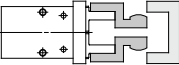
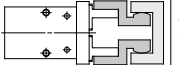
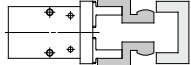
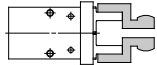
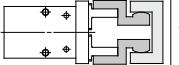
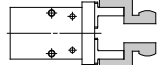
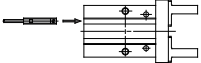
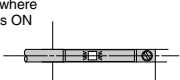
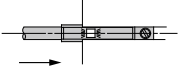
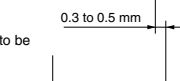
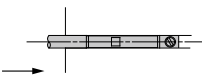
Various auto switch applications are possible through different combinations of auto switch quantities and detecting positions.

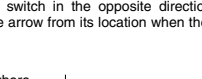
2) Detection when Gripping Interior of Workpiece

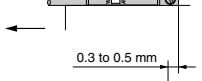
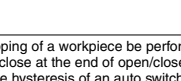
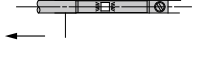
| Detection example | | 1. Confirmation of fingers in reset position | 2. Confirmation of workpiece held | 3. Confirmation of workpiece released |
|---|---|---|--|---|
| Position to be detected | | Position of fingers fully closed  | Position when gripping workpiece  | Position of fingers fully opened  |
| Operation of auto switch | | Auto switch turned ON when fingers return. (Light ON) | Auto switch turned ON when gripping a workpiece. (Light ON) | When a workpiece is not held (Abnormal operation): Auto switch to turn ON (Light ON) |
| Detection combinations | One auto switch *One position, any of ①, ②, and ③ can be detected. | ● | ● | ● |
| | Two auto switches *Two positions of ①, ②, and ③ can be detected. | ● | ● | — |
| | | ● | ● | ● |
| Pattern | A | — | ● | ● |
| B | — | ● | — | ● |
| C | ● | — | ● | ● |
| How to determine auto switch installation position | | Step 1) Fully close the fingers.  | Step 1) Position fingers for gripping a workpiece.  | Step 1) Fully open the fingers.  |
| At no pressure or low pressure, connect the auto switch to a power supply, and follow the directions. | | Step 2) Insert the auto switch into the switch installation groove in the direction shown in the following drawing. | | |
| | |  | | |
| | | Step 3) Move the auto switch in the direction of the arrow and fasten it at a position 0.3 to 0.5 mm beyond the position where the indicator light illuminates. | Step 3) Slide the auto switch in the direction of the arrow until the indicator light illuminates. | |
| | |  |  | |
| | | Position where light turns ON | Step 4) Slide the auto switch further in the direction of the arrow until the indicator light goes out. | |
|  |  | | | |
| Position to be secured | Step 5) Move the auto switch in the opposite direction 0.3 to 0.5 mm in the direction indicated by the arrow from its location when the indicator light comes on again. | | | |
|  |  | | | |
| Position where light turns ON | Position where light turns ON | | | |
|  |  | | | |
| Position to be secured | Position to be secured | | | |
|  |  | | | |

Note 1) It is recommended that gripping of a workpiece be performed close to the center of the finger stroke.

Note 2) When holding a workpiece close at the end of open/close stroke of fingers, detecting performance of the combinations listed in the above table may be limited, depending on the hysteresis of an auto switch, etc.

- MHZ
- MHF
- MHL
- MHR
- MHK
- MHS
- MHC
- MHT
- MHY
- MHW
- X□
- MRHQ
- MA
- D-□

MHZ2, MHZ□2 Series

Auto Switch Hysteresis

Auto switches have hysteresis similar to micro switches.
Use the table below as a guide when adjusting auto switch positions, etc.

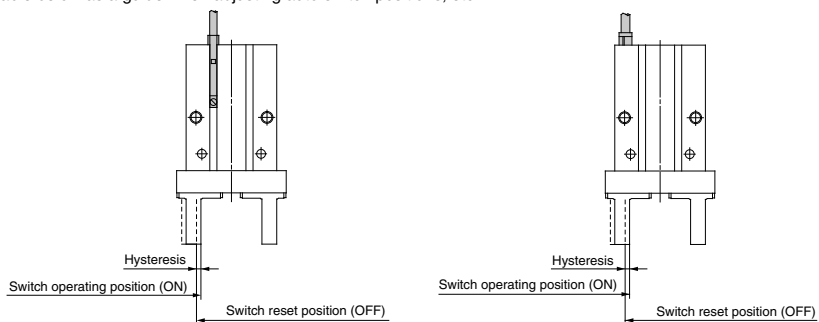

Hysteresis

| Auto switch model | D-Y59A/Y59B D-Y69A/Y69B D-Y7P(V) D-Y7□W(V) | D-F8□ | D-M9□(V) D-M9□W(V) D-M9□A(V) |
|---------------------|---|------------|------------------------------------|
| Air gripper model | | | |
| MHZ2-6□ | No setting | 0.5 | 0.5 |
| MHZ2-10□, MHZL2-10□ | 0.5 | No setting | 0.5 ^{Note)} |
| MHZ2-16□, MHZL2-16□ | 0.5 | 0.5 | 0.5 |
| MHZ2-20□, MHZL2-20□ | 0.5 | 0.5 | 0.8 |
| MHZ2-25□, MHZL2-25□ | 0.5 | 0.5 | 0.5 |
| MHZ2-32□ | 0.5 | 0.5 | 0.7 |
| MHZ2-40□ | 0.5 | 0.5 | 0.9 |
| MHZJ2-6□ | No setting | 0.5 | 0.5 |
| MHZJ2-10□ | | 0.5 | 0.5 |
| MHZJ2-16□ | | 0.5 | 0.5 |
| MHZJ2-20□ | | 0.5 | 0.8 |
| MHZJ2-25□ | | 0.5 | 0.5 |

Note) When mounting D-M9□(V), M9□W(V) and M9□A(V) on MHZ2-10□ and MHZL2-10, mounting brackets (BMG2-012) are required.

Auto Switch Mounting

Applicable models:

- MHZ2-6
- MHZJ2 Series
- Round groove of the MHZ2 series
- Round groove of the MHZL2 series

To set the auto switch, insert the auto switch into the auto switch installation groove of the gripper from the direction indicated in the following drawing. After setting the position, tighten the attached auto switch mounting screw with a flat head watchmaker's screwdriver.

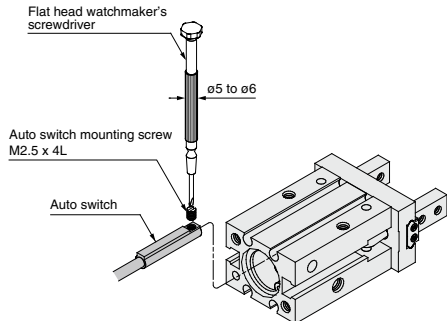

Note) Use a watchmaker's screwdriver with a grip diameter of 5 to 6 mm to tighten the auto switch mounting screw.
The tightening torque should be 0.05 to 0.15 N·m.

[Mounting of Auto Switch: Precautions]

When mounting an auto switch on the piping top surface of the MHZJ2-10□, the auto switch may not be mountable due to interference with the fitting. Use an extension fitting included with the product for the combinations in the table below.

| Auto switch model | One-touch Mini Fittings (KQ2H/KQ2S/KQ2L/KQ2W) KJH/KJS/KJL/KJW |
|-------------------|---|
| D-M9□(V) | × |
| D-M9□W(V) | × |
| D-F8□ | × |
| D-M9□A(V) | × |

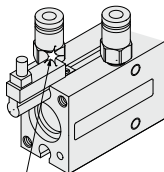

Interference between the auto switch and the fitting

Mounting dimensions of extension fitting

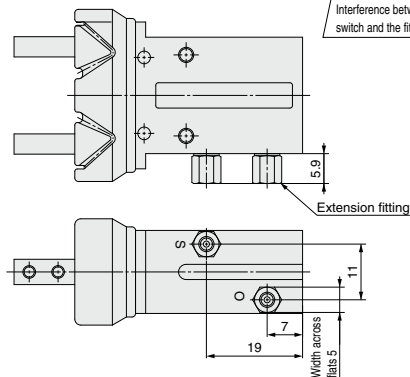

* When mounting extension fittings, first, tighten it by hand, then give it an additional 1/4 turn with a wrench.

Applicable models:

- Square groove on the side of the MHZ2 series
- Square groove on the side of the MHZL2 series

- (1) To set the auto switch, insert the auto switch into the installation groove of the cylinder as shown below and set it roughly.
- (2) Insert the auto switch into the auto switch bracket installation groove.
- (3) After confirming the detecting position, tighten the set screws (M2.5) attached to the auto switch and set it.
- (4) Be sure to change the detecting position in the state of (2).

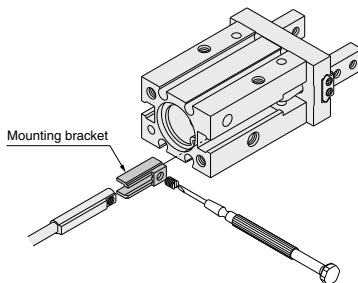

Auto Switch Mounting Bracket: Part No.

| Auto switch part no. | Auto switch mounting bracket part no. |
|----------------------|---------------------------------------|
| D-M9□(V) | BMG2-012 |
| D-M9□W(V) | |
| D-F8□ | |
| D-M9□A(V) | |

Note) Use a watchmaker's screwdriver with a grip diameter of 5 to 6 mm to tighten the set screws (M2.5).
The tightening torque should be 0.05 to 0.1 N·m.
As a guide, it should be turned about 90° beyond the point at which tightening can be felt.

Note) D-F8□ cannot be mounted on MHZ2-10□, MHZJ2-10□ and MHZL2-10□

[Handling of Mounting Brackets: Precautions]

When auto switch is set on the mounting side as shown below, allow at least 2 mm run off space on mounting plate since the auto switch is protruded from the gripper edge.

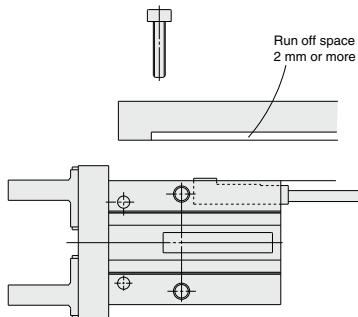

MHZ

MHF

MHL

MHR

MHK

MHS

MHC

MHT

MHY

MHW

-X□

MRHQ

MA

D-□

MHZ2, MHZ□2 Series

Protrusion of Auto Switch from Edge of Body

The amount of auto switch protrusion from the body's end surface is as shown in the table below.

Use this as a standard when mounting, etc.

D-F8□ has no protrusion from the body's end surface.

The end boss type has no protrusion either.

Standard Body

| Lead wire type | | In-line electrical entry type | | | Perpendicular electrical entry type | | | | |
|-------------------|-------------------------------|-------------------------------|-----------------|------------------------|-------------------------------------|------------------------|------------------------|------------------------|----------------------|
| | | Explanatory drawing | | | Explanatory drawing | | | | |
| Air gripper model | | D-Y59□ D-Y7P D-Y7□W | D-M9□ D-M9□W | D-M9□A | D-Y69□ D-Y7PV D-Y7□WV | D-M9□V D-M9□WV | D-M9□AV | | |
| Standard | MHZ2-6□ | Open | 11 | | No setting | 9 | 11 | | |
| | | Close | 13 | | | 11 | 13 | | |
| | MHZ2-10□ | Open | 1 | 3.5 ^{Note 3)} | 5.5 ^{Note 3)} | — | 1.5 ^{Note 3)} | 3.5 ^{Note 3)} | |
| | | Close | 7.5 | 6.5 ^{Note 3)} | 8.5 ^{Note 3)} | 6.5 | 4.5 ^{Note 3)} | 6.5 ^{Note 3)} | |
| | MHZ2-16□ | Open | — | 1 | 3 | — | — | — | |
| | | Close | 6 | 4 | 6 | 5 | 2 | 4 | |
| | MHZ2-20□ | Open | — | — | — | — | — | — | |
| | | Close | 4 | 2 | 4 | 3 | — | — | |
| | MHZ2-25□ | Open | — | — | — | — | — | — | |
| | | Close | 1 | — | — | — | — | — | |
| | MHZ2-32□ | Open | — | — | — | — | — | — | |
| | | Close | 3 | — | — | 2 | — | — | |
| | MHZ2-40□ | Open | — | — | — | — | — | — | |
| | | Close | 2 | — | — | 1 | — | — | |
| | With dust cover | MHZJ2-6□ | Open | 11 | 13 | No setting | 9 | 11 | |
| | | | Close | 13 | 15 | | 11 | 13 | |
| MHZJ2-10□ | | Open | 5 | 7 | 3 | | 5 | | |
| | | Close | 7 | 9 | 5 | | 7 | | |
| MHZJ2-16□ | | Open | 2 | 4 | — | | — | | |
| | | Close | 5 | 7 | 3 | | 5 | | |
| MHZJ2-20□ | | Open | — | — | — | | — | | |
| | | Close | 3 | 5 | 1 | | 3 | | |
| MHZJ2-25□ | | Open | — | — | — | | — | | |
| | | Close | 2 | 4 | — | | — | | |
| Long stroke | Double acting | MHZL2-10D | Open | 0.5 | 1.5 ^{Note 3)} | 3.5 ^{Note 3)} | — | — | |
| | | | Close | 8.5 | 8 ^{Note 3)} | 10 ^{Note 3)} | 7.5 | 6 ^{Note 3)} | 8 ^{Note 3)} |
| | | MHZL2-16D | Open | — | — | — | — | — | — |
| | | | Close | 8 | 6 | 8 | 7 | 4 | 6 |
| | MHZL2-20D | Open | — | — | — | — | — | — | |
| | | Close | 7 | 5 | 7 | 6 | 3 | 5 | |
| | MHZL2-25D | Open | — | — | — | — | — | — | |
| | | Close | 5.5 | 3.5 | 5.5 | 4.5 | 1.5 | 3.5 | |
| | Single acting (Normally open) | MHZL2-10S | Open | — | — | — | — | — | |
| | | | Close | — | — | — | — | — | |
| | | MHZL2-16S | Open | — | — | — | — | — | |
| | | | Close | 3 | 1 | 3 | 2 | — | — |
| | | MHZL2-20S | Open | — | — | — | — | — | |
| | | | Close | 1 | — | — | — | — | |
| | | MHZL2-25S | Open | — | — | — | — | — | |
| | | | Close | — | — | — | — | — | |
| | | MHZL2-10C | Open | — | — | — | — | — | |
| | | | Close | 5.5 | 5 ^{Note 3)} | 7 ^{Note 3)} | 4.5 | 3 ^{Note 3)} | 5 ^{Note 3)} |
| MHZL2-16C | | Open | — | — | — | — | — | | |
| | | Close | 5.5 | 3.5 | 5.5 | 4.5 | 1.5 | 3.5 | |
| MHZL2-20C | | Open | — | — | — | — | — | | |
| | | Close | 3.5 | 1.5 | 3.5 | 2.5 | — | — | |
| MHZL2-25C | Open | — | — | — | — | — | | | |
| | Close | 1.5 | — | — | 0.5 | — | — | | |

Note 1) There is no protrusion if no values are entered in the table.

Note 2) The actual mounting position should be adjusted after confirming the auto switch operating conditions.

Note 3) When mounting D-M9□(V), M9□W(V) and M9□A(V) on MHZ2-10□ and MHZL2-10□, mounting brackets (BMG2-012) are required.

1 Built-in needle valve for finger speed control

Symbol
-X46

Installation of a variable throttle allows adjustment of the finger opening/closing speed.

How to Order

MHZ2 – **Bore size** **D** □ □ – **X46**

Finger position/Option

Body option

| |
|-----|
| NII |
| E |
| W |

Built-in needle valve for finger speed control

Specifications

| | |
|--|--|
| Bore size (mm) | 10, 16, 20, 25 |
| Action | Double acting |
| Needle position | Refer to the dimensions and figures below. |
| Specifications/dimensions other than the above | Same as the standard type |

Note) Not available for ø6, ø32 and ø40.

Dimensions (Dimensions other than specified below are the same as the standard type.)

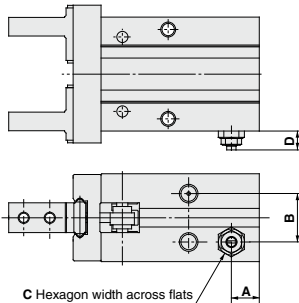

| Model | A | B | C | D* (mm) |
|--------------------------------|------|----|-----|---------|
| MHZ2-10D □□- X46 | 9 | 11 | 4.5 | 5.2 |
| MHZ2-16D □□- X46 | 7.5 | 13 | 7 | 5.8 |
| MHZ2-20D □□- X46 | 10 | 15 | 7 | 6 |
| MHZ2-25D □□- X46 | 10.7 | 20 | 7 | 6.2 |

Dimensions other than the above are identical to the standard type; refer to pages 417 to 420.

* Reference values to establish criteria for needle adjustment.

Adjust so that the finger opening/closing speed will be no greater than necessary. If the finger opening/closing speed is greater than necessary, impact forces acting on the fingers and other parts will increase. This can cause a loss of repeatability when gripping workpieces and have an adverse effect on the life of the unit.

This needle is used to adjust the finger closing speed. When adjusting the opening speed (attenuating impact during operation, etc.), use a meter-out control speed controller AS series.

Guide for Internal Needle Adjustment

| Model | Number of rotations from fully closed needle condition <small>(Note)</small> |
|--------------------------------|--|
| MHZ2-10D □□- X46 | 1/4 to 1/2 |
| MHZ2-16D □□- X46 | 1/2 to 1 |
| MHZ2-20D □□- X46 | 1 to 1 1/2 |
| MHZ2-25D □□- X46 | 1 1/2 to 2 |

Note) The condition in which the needle is tightened gently until it stops.

MHZ

MHF

MHL

MHR

MHK

MHS

MHC

MHT

MHY

MHW

-X□

MRHQ

MA

D-□

2 MHQ2/MHQG2 Compatible Flat Type Fingers

Symbol
-X51

Previous MHQ2/MHQG2 series compatible flat type finger is selectable for the MHZ2 series.

How to Order

MHZ2 – **Bore size** [] [] [] – **X51**

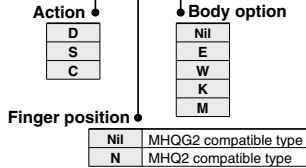

Specifications

| | |
|--|---|
| Bore size (mm) | 10, 16, 20, 25 |
| Action | Double acting, Single acting (normally open, normally closed) |
| Finger dimensions | Refer to the dimensions and figures below. |
| Specifications/dimensions other than the above | Same as the standard type |

Note 1) Not available for ø6, ø32 and ø40.

Note 2) An option symbol (3) for the flat finger type is not specified.

Dimensions (Dimensions other than specified below are the same as the standard type.)

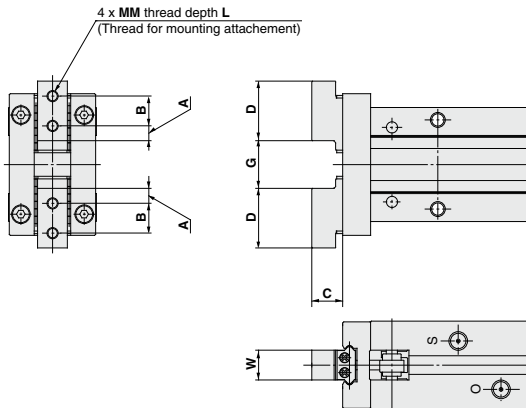

| Model | | A | B | C | D | G | | MM | L | W |
|----------------|------------------|-----|----|------|------|--------------------------------------|----------------------------------|----------|-----|----------------------------------|
| | | | | | | Open | Closed | | | |
| MHZ2-10□□□-X51 | MHQG2 compatible | 3 | 6 | 5.2 | 12 | 9.7 ^{+0.2} _{-0.2} | 5.7 ⁰ _{-0.4} | M2 x 0.4 | 3.6 | 5 ⁰ _{-0.05} |
| | MHQ2 compatible | 2 | 5 | 5.2 | 9 | 9.7 ^{+0.2} _{-0.2} | 5.7 ⁰ _{-0.4} | M2 x 0.4 | 3.6 | 5 ⁰ _{-0.05} |
| MHZ2-16□□□-X51 | MHQG2 compatible | 4 | 8 | 8.3 | 16 | 12.6 ^{+0.2} _{-0.2} | 6.6 ⁰ _{-0.4} | M3 x 0.5 | 6 | 8 ⁰ _{-0.05} |
| | MHQ2 compatible | 2.5 | 7 | 8.3 | 12 | 12.6 ^{+0.2} _{-0.2} | 6.6 ⁰ _{-0.4} | M3 x 0.5 | 6 | 8 ⁰ _{-0.05} |
| MHZ2-20□□□-X51 | MHQG2 compatible | 5 | 10 | 10.5 | 20.8 | 17.2 ^{+0.2} _{-0.2} | 7.2 ⁰ _{-0.4} | M4 x 0.7 | 8 | 10 ⁰ _{-0.05} |
| | MHQ2 compatible | 3.3 | 9 | 10.5 | 15.5 | 17.2 ^{+0.2} _{-0.2} | 7.2 ⁰ _{-0.4} | M4 x 0.7 | 8 | 10 ⁰ _{-0.05} |
| MHZ2-25□□□-X51 | MHQG2 compatible | 6.5 | 12 | 13.1 | 25 | 22.8 ^{+0.5} _{-0.5} | 8.8 ⁰ _{-0.4} | M5 x 0.8 | 10 | 12 ⁰ _{-0.05} |
| | MHQ2 compatible | 3.5 | 12 | 13.1 | 19 | 22.8 ^{+0.5} _{-0.5} | 8.8 ⁰ _{-0.4} | M5 x 0.8 | 10 | 12 ⁰ _{-0.05} |



MHZ Series Specific Product Precautions

Be sure to read this before handling the products.

Mounting Air Grippers/MHZ□2 Series

Possible to mount from 3 directions.

How to mount air grippers

Axial mounting (Body tapped)

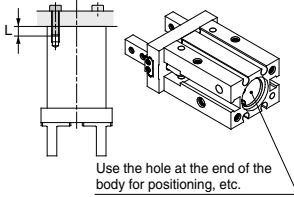

| Model | Applicable bolts | Max. tightening torque (N·m) | Max. screw-in depth (L, mm) |
|--------------------------|------------------|------------------------------|-----------------------------|
| MHZ□2-6 ^(max) | M2 x 0.4 | 0.15 | 4.5 |
| MHZ□2-10 | M3 x 0.5 | 0.88 | 6 |
| MHZ□2-16 | M4 x 0.7 | 2.1 | 8 |
| MHZ□2-20 | M5 x 0.8 | 4.3 | 10 |
| MHZ□2-25 | M6 x 1 | 7.3 | 12 |
| MHZ□2-32 | M6 x 1 | 7.9 | 13 |
| MHZ□2-40 | M8 x 1.25 | 17.7 | 17 |

Note) Axial mounting type is not available for MHZ2-6 and MHZJ2-6.

| Model | Hole diameter (mm) | Hole depth (mm) |
|----------|-------------------------|-----------------|
| MHZ□2-6 | $\phi 7H_8^{+0.022}_0$ | 1.5 |
| MHZ□2-10 | $\phi 11H_9^{+0.043}_0$ | 2 |
| MHZ□2-16 | $\phi 17H_9^{+0.043}_0$ | 2 |
| MHZ□2-20 | $\phi 21H_9^{+0.052}_0$ | 3 |
| MHZ□2-25 | $\phi 26H_9^{+0.052}_0$ | 3.5 |
| MHZ□2-32 | $\phi 34H_9^{+0.062}_0$ | 4 |
| MHZ□2-40 | $\phi 42H_9^{+0.062}_0$ | 4 |

Perpendicular mounting (Body tapping)

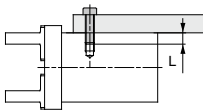

| Model | Applicable bolts | Max. tightening torque (N·m) | Max. screw-in depth (L, mm) |
|--------------------------|------------------|------------------------------|-----------------------------|
| MHZ□2-6 ^(max) | M2 x 0.4 | 0.15 | 4 |
| MHZ□2-10 | M3 x 0.5 | 0.9 | 6 |
| MHZ□2-16 | M4 x 0.7 | 1.6 | 4.5 |
| MHZ□2-20 | M5 x 0.8 | 3.3 | 8 |
| MHZ□2-25 | M6 x 1 | 5.9 | 10 |
| MHZ□2-32 | M6 x 1 | 5.9 | 10 |
| MHZ□2-40 | M8 x 1.25 | 13.7 | 13 |

Note) Except MHZ2-6 and MHZJ2-6.

How to mount air grippers

Lateral mounting (Body tapped and through-hole)

●Body tapped

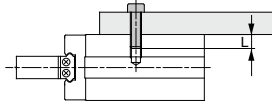

| Model | Applicable bolts | Max. tightening torque (N·m) | Max. screw-in depth (L, mm) |
|----------|------------------|------------------------------|-----------------------------|
| MHZ□2-6 | M3 x 0.5 | 0.88 | 10 |
| MHZ□2-10 | M3 x 0.5 | 0.69 | 5 |
| MHZ□2-16 | M4 x 0.7 | 2.1 | 8 |
| MHZ□2-20 | M5 x 0.8 | 4.3 | 10 |
| MHZ□2-25 | M6 x 1 | 7.3 | 12 |
| MHZ□2-32 | M6 x 1 | 7.9 | 13 |
| MHZ□2-40 | M8 x 1.25 | 17.7 | 16 |

●Body through-holes

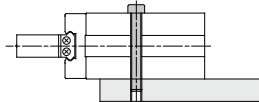

| Model | Applicable bolts | Max. tightening torque (N·m) |
|----------|------------------|------------------------------|
| MHZ□2-6 | M2.5 x 0.45 | 0.49 |
| MHZ□2-10 | M2.5 x 0.45 | 0.49 |
| MHZ□2-16 | M3 x 0.5 | 0.88 |
| MHZ□2-20 | M4 x 0.7 | 2.1 |
| MHZ□2-25 | M5 x 0.8 | 4.3 |
| MHZ□2-32 | M5 x 0.8 | 4.3 |
| MHZ□2-40 | M6 x 1 | 7.3 |

Note) Use body tapped for D-Y59, D-Y69, D-Y7P with auto switch types. Make sure that the bolt's screw-in depth is less than those shown in the table below to prevent the tip of the bolt from pressing the switch body.

| Model | Max. screw-in depth (L, mm) |
|----------|-----------------------------|
| MHZ□2-6 | — |
| MHZ□2-10 | 5 |
| MHZ□2-16 | 8 |
| MHZ□2-20 | 10 |
| MHZ□2-25 | 12 |
| MHZ□2-32 | 13 |
| MHZ□2-40 | 16 |

How to mount the attachment to the finger

The attachment must be mounted on fingers using bolts such as finger mounting female threads, etc., which should be tightened with the tightening torque in the table below.

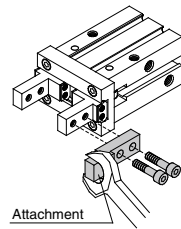

| Model | Applicable bolts | Max. tightening torque (N·m) |
|----------|------------------|------------------------------|
| MHZ□2-6 | M2 x 0.4 | 0.15 |
| MHZ□2-10 | M2.5 x 0.45 | 0.31 |
| MHZ□2-16 | M3 x 0.5 | 0.59 |
| MHZ□2-20 | M4 x 0.7 | 1.4 |
| MHZ□2-25 | M5 x 0.8 | 2.8 |
| MHZ□2-32 | M6 x 1 | 4.9 |
| MHZ□2-40 | M8 x 1.25 | 11.8 |

MHZ

MHF

MHL

MHR

MHK

MHS

MHC

MHT

MHY

MHW

-X□

MRHQ

MA

D-□

Operating Environment

⚠ Caution

Use caution for the anti-corrosiveness of linear guide section.

Martensitic stainless steel is used for the finger guide. But, use caution that anti-corrosiveness is inferior to the austenitic stainless steel. Especially, in an environment where waterdrops are adhered by condensation, etc., rust might be generated.

High Rigidity

MHQG2 Series

ø32, ø40

With guide holder

Possible to mount the solid state auto switch with indicator light.



Specifications

| | | | |
|-------------------------------|---------------|---------------|--|
| Fluid | | Air | |
| Operating pressure | Double acting | | 0.1 to 0.6 MPa |
| | Single acting | Normally open | 0.25 to 0.6 MPa |
| Normally closed | | | |
| Ambient and fluid temperature | | | -10 to 60°C |
| Repeatability | | | ø32, 40: ±0.02 mm |
| Max. operating frequency | | | ø32, 40: 60 c.p.m |
| Lubrication | | | Not required |
| Operating system | | | Double acting, Single acting |
| Auto switch (Option) * | | | Solid state auto switch: D-M9N(V), D-M9P(V), D-M9B(V), D-Y59 _ø , D-Y69 _ø |

* Refer to pages 797 to 850 for the detailed specifications of auto switches.

Model

| Operating system | Model | Cylinder bore (mm) | Gripping force ^{Note 1)} (Effective value) N | Opening/Closing stroke (mm) | Weight ^{Note 2)} (g) | |
|------------------|-----------------|--------------------|--|-----------------------------|----------------------------------|------|
| Double acting | MHQG2-32D | 32 | External grip: 88 Internal grip: 139 | 20 | 1100 | |
| | MHQG2-40D | 40 | External grip: 158 Internal grip: 247 | 28 | 1940 | |
| Single acting | Normally open | MHQG2-32S | 32 | 69 | 20 | 1110 |
| | | MHQG2-40S | 40 | 130 | 28 | 1960 |
| | Normally closed | MHQG2-32C | 32 | 127 | 20 | 1110 |
| | | MHQG2-40C | 40 | 227 | 28 | 1960 |

Note 1) Values at the pressure of 0.5 MPa. Double acting is compatible with both external and internal gripping forces, while single acting and normally open external gripping force, and single acting and normally closed internal gripping force.

Note 2) Values excluding weight of auto switch.

Symbol

Double acting: Internal grip

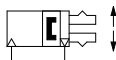

Double acting: External grip

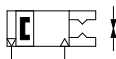

Single acting/Normally closed: Internal grip

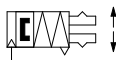

Single acting/Normally open: External grip



With Dust Cover

MHQJ2 Series

ø10, ø16, ø20, ø25

Air gripper with dustproof and dripproof construction

Enclosure to prevent accumulation of dust.

Sealed construction with a dust cover

Possible to mount the solid state auto switch with indicator light.

Three-type dust cover variations for diversified applications



Symbol

Double acting: Internal grip

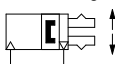

Double acting: External grip

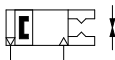

Single acting/Normally closed: Internal grip

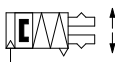

Single acting/Normally open: External grip



Specifications

| | | | |
|-------------------------------|---------------|---|-----------------|
| Fluid | | Air | |
| Operating pressure | Double acting | | 0.1 to 0.6 MPa |
| | Single acting | Normally open | 0.25 to 0.6 MPa |
| Normally closed | | | |
| Ambient and fluid temperature | | -10 to 60°C | |
| Repeatability | | ±0.01 mm | |
| Max. operating frequency | | 180 c.p.m | |
| Lubrication | | Not required | |
| Operating system | | Double acting, Single acting | |
| Auto switch (Option) * | | Solid state auto switch: D-M9N(V), D-M9P(V), D-M9B(V) | |

* Refer to pages 797 to 850 for the detailed specifications of auto switches.

Model

| Operating system | Model | Cylinder bore (mm) | Gripping force ^{Note 1)} (Effective value) N | Opening/Closing stroke (mm) | Weight ^{Note 2)} (g) | |
|------------------|-----------------|--------------------|--|-----------------------------|----------------------------------|-----|
| Double acting | MHQJ2-10D | 10 | 11 | 4 | 90 | |
| | MHQJ2-16D | 16 | 34 | 6 | 180 | |
| | MHQJ2-20D | 20 | 42 | 10 | 340 | |
| | MHQJ2-25D | 25 | 63 | 14 | 640 | |
| Single acting | Normally open | MHQJ2-10S | 10 | 7.8 | 4 | 90 |
| | | MHQJ2-16S | 16 | 26 | 6 | 181 |
| | | MHQJ2-20S | 20 | 33 | 10 | 342 |
| | Normally closed | MHQJ2-25S | 25 | 49 | 14 | 643 |
| | | MHQJ2-10C | 10 | 7.8 | 4 | 90 |
| | | MHQJ2-16C | 16 | 26 | 6 | 181 |
| | | MHQJ2-20C | 20 | 33 | 10 | 342 |
| | | MHQJ2-25C | 25 | 49 | 14 | 643 |

Note 1) Values at the pressure of 0.5 MPa. Double acting is compatible with both external and internal gripping forces, while single acting and normally open external gripping force, and single acting and normally closed internal gripping force.

Note 2) Values excluding weight of auto switch.

MHZ

MHF

MHL

MHR

MHK

MHS

MHC

MHT

MHY

MHW

-X□

MRHQ

MA

D-□