

# MGJ2 Surface Mount Series

5.7kVDC Isolated 2W SM Gate Drive DC-DC Converters



## FEATURES

- Patent protected
- Optimised bipolar output voltages for IGBT/SiC & MOSFET gate drives
- Reinforced insulation to UL62368 recognition pending
- ANSI/AAMI ES60601-1 recognition pending
- 5.7kVDC isolation test voltage 'Hi Pot Test'
- Ultra low isolation capacitance
- Surface mount package style
- 5V, 12V & 15V inputs
- +15V/-9V, +15V/-5V & +20V/-5V outputs
- Operation up to 100°C (with derating)
- Short circuit protection
- Characterised CMTI >200kV/μS
- Continuous barrier withstand voltage 2.5kV
- Characterised partial discharge performance

## PRODUCT OVERVIEW

The MGJ2 series of DC-DC converters is ideal for powering 'high side' and 'low side' gate drive circuits for IGBTs/SiC and MOSFETs in bridge circuits. A choice of asymmetric output voltages allows optimum drive levels for best system efficiency. The MGJ2 series is characterised for high isolation requirements commonly seen in bridge circuits used in motor drives and inverters, while the MGJ2 industrial grade temperature rating and construction gives long service life and reliability.

## SELECTION GUIDE

Order Code <sup>1</sup>	Nominal Input Voltage	Output Voltage 1	Output Voltage 2	Output Current 1	Output Current 2	Input Current at Rated Load	Output 1		Output 2	
	V	V	V	mA		%		%		
						Load Regulation (Typ)	Load Regulation (Max)	Load Regulation (Typ)	Load Regulation (Max)	
MGJ2D051505MPC	5	15	-5	100	100	540	8	10	6	9
MGJ2D051509MPC	5	15	-9	80	80	540	7	11	6.5	10
MGJ2D052005MPC <sup>4</sup>	5	20	-5	80	80	500		10		9
MGJ2D121505MPC	12	15	-5	100	100	210	9	14	7	12
MGJ2D121509MPC	12	15	-9	80	80	210	8	13	7	12
MGJ2D122005MPC <sup>4</sup>	12	20	-5	80	80	250		12		7
MGJ2D151505MPC	15	15	-5	100	100	170	7	11	5.5	9
MGJ2D151509MPC	15	15	-9	80	80	170	6	10	5	9
MGJ2D152005MPC <sup>4</sup>	15	20	-5	80	80	200		8		7

## SELECTION GUIDE (Continued)

Order Code <sup>1</sup>	Ripple & Noise (Typ) <sup>3</sup>	Ripple & Noise (Max) <sup>3</sup>	Efficiency (Min)	Efficiency (Typ)	Isolation Capacitance	MTTF <sup>2</sup>	
	mVp-p		%		pF	MIL. kWhrs	Tel. kWhrs
MGJ2D051505MPC	25	45	68	72.5	3	1362	13487
MGJ2D051509MPC	20	45	69	73	3	1221	12733
MGJ2D052005MPC <sup>4</sup>		50	64	71	3		
MGJ2D121505MPC	35	55	73	77	3	1411	52799
MGJ2D121509MPC	20	45	72	77	3	1548	47759
MGJ2D122005MPC <sup>4</sup>		50	69	76	3		
MGJ2D151505MPC	30	65	72	77	3	1224	56429
MGJ2D151509MPC	20	45	73	77	3	1332	56879
MGJ2D152005MPC <sup>4</sup>		50	71	76	3		

## INPUT CHARACTERISTICS

Parameter	Conditions	Min.	Typ.	Max.	Units
Voltage range	Continuous operation, 5V input types	4.5	5	5.5	V
	Continuous operation, 12V input types	10.8	12	13.2	
	Continuous operation, 15V input types	13.5	15	16.5	
Input short circuit current $I_{sc}$	5V input types		100		mA
	12V input types		90		
	15V input types		55		
Input reflected ripple	5V input type		10		mA p-p
	All others		5		



For full details go to [www.murata-ps.com/rohs](http://www.murata-ps.com/rohs)

1. Components are supplied in tape and reel packaging, please refer to package specification section. Orderable part numbers are MGJ2D051505MPC-R7 (80 pieces per reel), or MGJ2D051505MPC-R13 (400 pieces per reel).

2. Calculated using MIL-HDBK-217 FN2 and Telcordia SR-332 calculation model with nominal input voltage at full load.

3. See ripple & noise test method.

4. MGJ2Dxx2005MPC variants are in preliminary stages.

All specifications typical at  $T_a=25^\circ\text{C}$ , nominal input voltage and rated output current unless otherwise specified

OUTPUT CHARACTERISTICS					
Parameter	Conditions	Min.	Typ.	Max.	Units
Rated Power	T <sub>A</sub> =-40°C to 85°C			2.0	W
Voltage Set Point Accuracy	See tolerance envelopes				
Line regulation	5V input types		1.05	1.1	%/%
	MGJ2D121505MPC		1.1	1.25	
	MGJ2D121509MPC		1.1	1.3	
	15V input types		1.1	1.2	
	All others				

ISOLATION CHARACTERISTICS					
Parameter	Conditions	Min.	Typ.	Max.	Units
Isolation test voltage	Production tested for 1 second	5700			VDC
	Qualification tested for 1 minute	5700			
Resistance	Viso= 1000VDC	1			GΩ
Continuous barrier withstand voltage	Non-safety barrier application			2000	V
Safety standard <sup>1</sup>	UL62368-1	Reinforced	Creepage and clearance 9mm	250	VAC
	ANSI/AAMI ES60601-1	2 MOPP		250	

GENERAL CHARACTERISTICS					
Parameter	Conditions	Min.	Typ.	Max.	Units
Switching frequency	5V input type		85		kHz
	12 input type		110		
	151505		100		
	151509		90		

TEMPERATURE CHARACTERISTICS					
Parameter	Conditions	Min.	Typ.	Max.	Units
Specification	All output types (see derating curves)	-40		100	°C
Storage		-40		125	
Product Temperature above ambient	5V input types		35		
	12V input types		27		
	15V input types		25		
Cooling	Free air convection				

ABSOLUTE MAXIMUM RATINGS	
Short-circuit protection	Continuous
Input voltage V <sub>IN</sub> , MGJ2D05	6V
Input voltage V <sub>IN</sub> , MGJ2D12	15V
Input voltage V <sub>IN</sub> , MGJ2D15	18V

1. UL62368-1 and ANSI/AAMI ES60601-1 recognition is currently pending.

## TECHNICAL NOTES

### ISOLATION VOLTAGE

'Hi Pot Test', 'Flash Tested', 'Withstand Voltage', 'Proof Voltage', 'Dielectric Withstand Voltage' & 'Isolation Test Voltage' are all terms that relate to the same thing, a test voltage, applied for a specified time, across a component designed to provide electrical isolation, to verify the integrity of that isolation.

Murata Power Solutions MGJ2 series of DC-DC converters are all 100% production tested at 5.7kVDC for 1 second and have been qualification tested at 5.7kVDC for 1 minute.

A question commonly asked is, "What is the continuous voltage that can be applied across the part in normal operation?"

When the insulation in the MGJ2 series is not used as a safety barrier, i.e. provides functional isolation only, continuous or switched voltages across the barrier up to 2.5kV are sustainable. Long term reliability testing at these voltages continues. Peak Inception voltages measured were in excess of 2.5kV when testing for partial discharge in accordance with IEC 60270. Please contact Murata for further information.

The MGJ2 series is pending recognition by Underwriters Laboratory to 250VAC Reinforced Insulation, please see safety approval section below.

### REPEATED HIGH-VOLTAGE ISOLATION TESTING

It is well known that repeated high-voltage isolation testing of a barrier component can actually degrade isolation capability, to a lesser or greater degree depending on materials, construction and environment. We therefore strongly advise against repeated high voltage isolation testing, but if it is absolutely required, that the voltage be reduced by 20% from specified test voltage.

## SAFETY APPROVAL

### ANSI/AAMI ES60601-1

The MGJ2 series is pending recognition by Underwriters Laboratory (UL) to ANSI/AAMI ES60601-1 and provides 2 MOPP (Means Of Patient Protection) based upon a working voltage of 250VAC max, between Primary and Secondary.

### UL62368-1

The MGJ2 series is pending recognition by Underwriters Laboratory (UL) to UL62368-1 for reinforced insulation to a working voltage of 250VAC.

Creepage and clearance 9mm.

Working altitude 5000m

## RoHS COMPLIANCE AND MSL INFORMATION



This series is compatible with Pb-Free soldering systems and is also backward compatible with Sn/Pb soldering systems. The series can be soldered in accordance with J-STD-020. Please refer to [application notes](#) for further information. This series have a classification temperature of 260°C and moisture sensitivity level 2. The termination finish on this product is Gold with plating thickness 0.12 microns.

### ENVIRONMENTAL VALIDATION TESTING

The following tests have been conducted on this product series, as part of our design verification process. The datasheet characteristics specify user operating conditions for this series, please contact Murata if further information about the tests is required.

Test	Standard	Condition
Temperature cycling	JEDEC JESD22-A104	500 cycles in a dual zone chamber from -40 (+5/-10)°C to 105 (+10/-5)°C. 15mins dwell at each (inclusive of ramps). 2 cycles per hour.
Humidity (unbiased)	JEDEC JESD22-A101	85±2°C, 85±5% R.H. for 1000 (+168/-24) hours
Storage life	JEDEC JESD22-A103, Condition A	125°C +10/-0°C for ≥1000 hours
Vibration	BS EN 61373 with respect to BS EN 60068-2-64, Test Fh Category 1 Class B	5 – 150Hz. Level at each axis – Vertical, Traverse and Longitudinal: 5.72m/s2 rms. 5 hours in each axis. Crest factor: 3 Sigma. Device is secured via the pads.
Shock	BS EN 61373: 2010 Category 1, Class B	Test is 30ms duration, 3 shocks in each sense of 3 mutually perpendicular axes (18 shocks total). Level at each axis: Vertical, Traverse and Longitudinal: 50m/s2. Device is secured via the pads.
Solderability	Based on EIA/IPC/JEDEC J-STD-002, Test B1	For lead free solderability the parts are conditioned in a dry bake for 4 hours ± 15 min. at a temperature of 155°C. Dipped in solder at 245°C ±5°C for 7-10 seconds.
Solvent cleaning	Resistance to cleaning agents	Solvent – Novec 71IPA & Topklean EL-20A. Pulsed ultrasonic immersion 45°C- 65°C
Solvent resistance	MIL-STD-883 Method 2015	The parts and the bristle portion of the brush are immersed in Isopropanol for a minimum of 1 minute. The parts are brushed 3 times, after the third time the parts are blown dry and inspected.

### PART NUMBER STRUCTURE

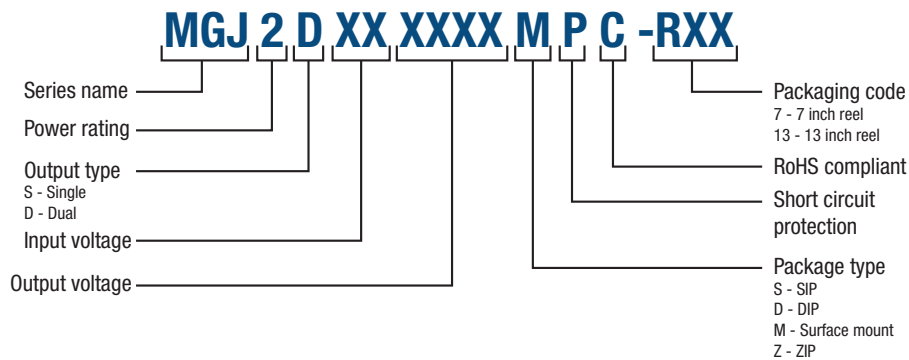

## CHARACTERISATION TEST METHODS

### Ripple & Noise Characterisation Method

Ripple and noise measurements are performed with the following test configuration.

C1	1 $\mu$ F X7R multilayer ceramic capacitor, voltage rating to be a minimum of 3 times the output voltage of the DC-DC converter
C2	10 $\mu$ F tantalum capacitor, voltage rating to be a minimum of 1.5 times the output voltage of the DC-DC converter with an ESR of less than 100m $\Omega$ at 100 kHz
C3	100nF multilayer ceramic capacitor, general purpose
R1	450 $\Omega$ resistor, carbon film, $\pm$ 1% tolerance
R2	50 $\Omega$ BNC termination
T1	3T of the coax cable through a ferrite toroid
RLOAD	Resistive load to the maximum power rating of the DC-DC converter. Connections should be made via twisted wires

Measured values are multiplied by 10 to obtain the specified values.

### Differential Mode Noise Test Schematic

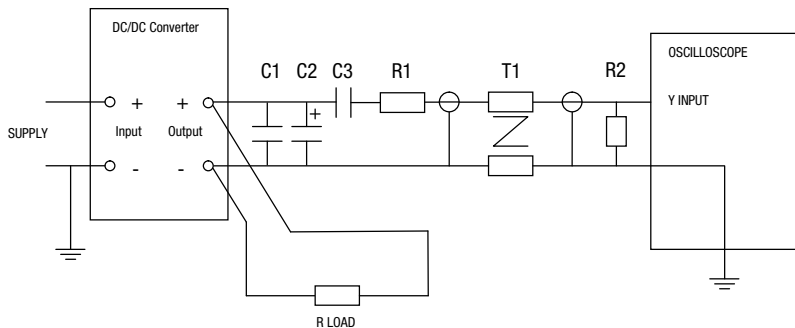

## APPLICATION NOTES

### Minimum load

The minimum load to meet datasheet specification is 10% of the full rated load across the specified input voltage range. Lower than 10% minimum loading will result in an increase in output voltage, which may rise to typically 1.25 times the specified output voltage if the output load falls to less than 5%.

### Gate Drive Applications Advisory Note

For general guidance for product usage in gate drive applications please refer to "[gate drive application notes](#)".

### Capacitive loading and start up

	Start-up time ms
	10 $\mu$ F
MGJ2D051505MPC	5
MGJ2D051509MPC	6
MGJ2D052005MPC	
MGJ2D121505MPC	3
MGJ2D121509MPC	4
MGJ2D122005MPC	
MGJ2D151505MPC	3
MGJ2D151509MPC	4
MGJ2D152005MPC	

Typical Start-Up Wave Form

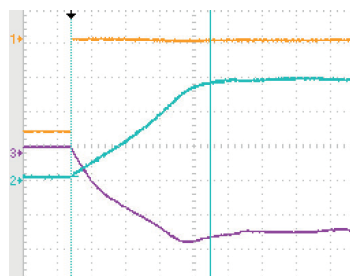

**APPLICATION NOTES (Continued)**

The MGJ2 series is a dual output DC-DC specifically designed for gate drive applications and its output configuration is not suitable for application usage as a general dual output DC-DC converter. However the MGJ2 series can be used as a general purpose single output converter, by loading from +Vout to -Vout.

The MGJ2 series provides a dual output by using a patented pnp emitter follower current shunt divider network circuit with short circuit protection.

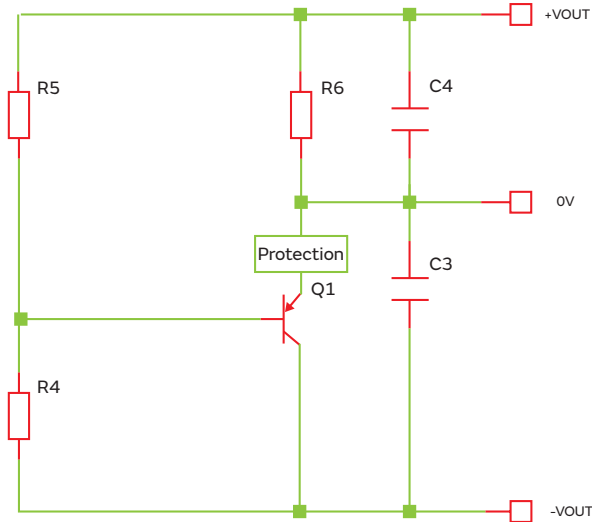

**Optional Configuration:**

For optional configuration where alternative negative output voltages are required, an external zener diode network can be connected across the main 20V or 24V output. However this zener diode will no longer be protected from short circuits as the internal short circuit protection is bypassed.

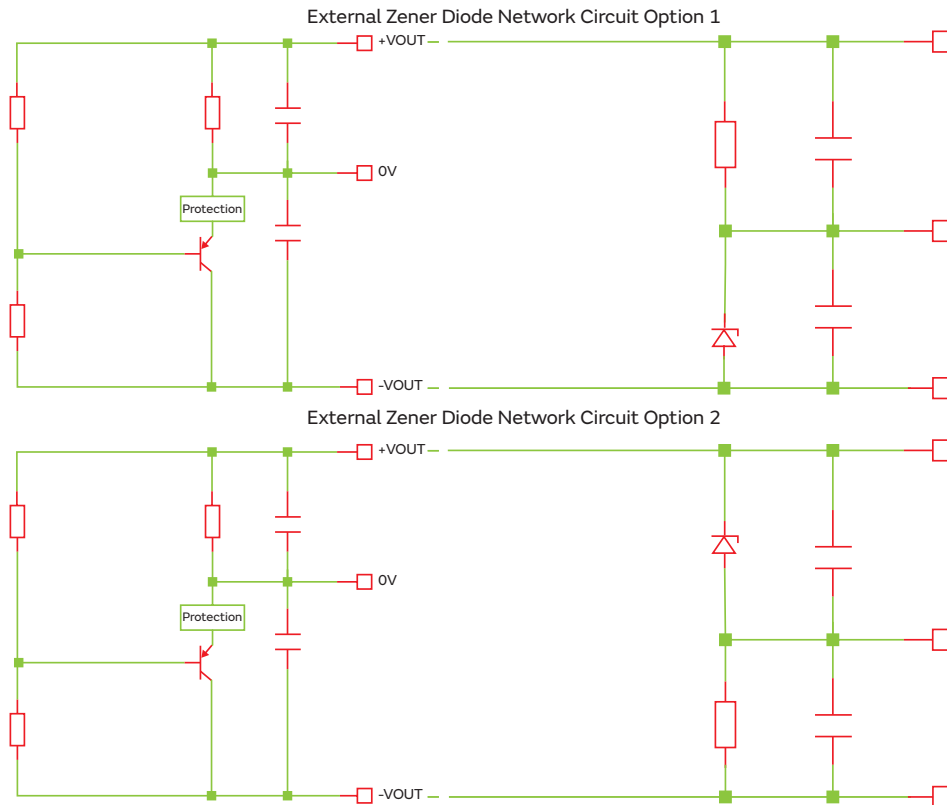

**APPLICATION NOTES (Continued)**

Schematic for driving IGBT, SiC & MOSFET

MGJ2 DC-DC CONNECTIONS FOR DRIVING IGBT DEVICES

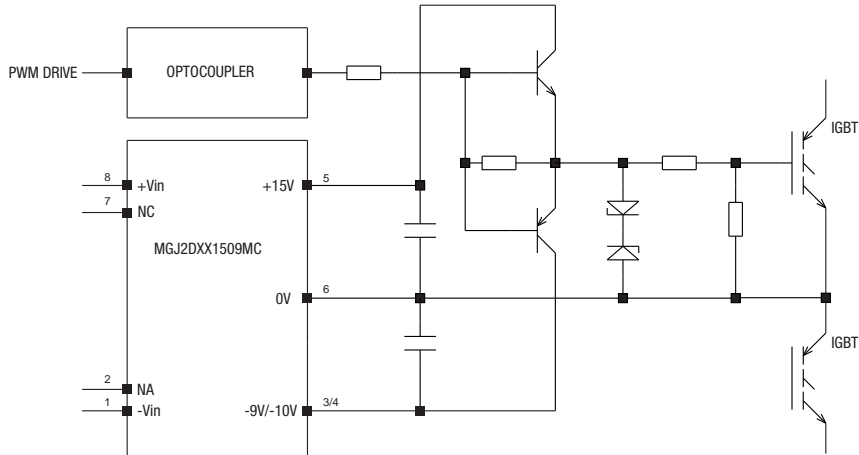

MGJ2 DC-DC CONNECTIONS FOR DRIVING SiC DEVICES

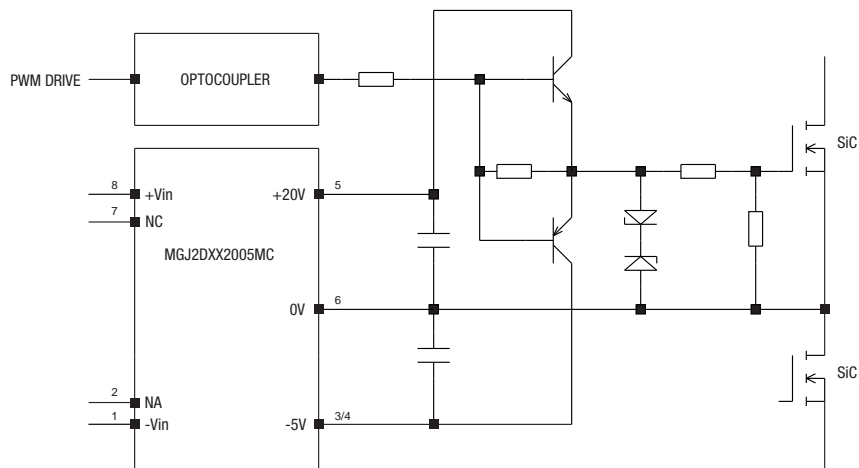

MGJ2 DC-DC CONNECTIONS FOR DRIVING MOSFET DEVICES

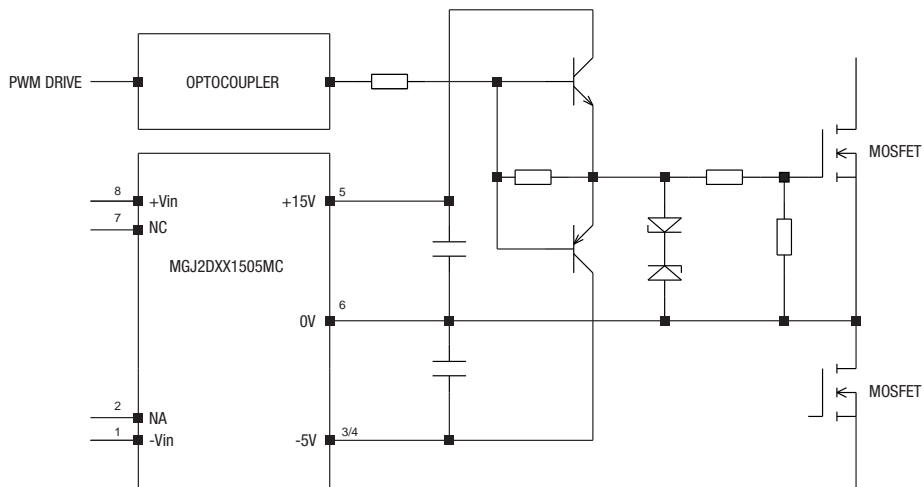

## POSITIVE OUTPUT VOLTAGE TOLERANCE ENVELOPES

The voltage tolerance envelopes show typical load regulation characteristics for this product series. The tolerance envelope is the maximum output voltage variation due to changes in output loading and set point accuracy.

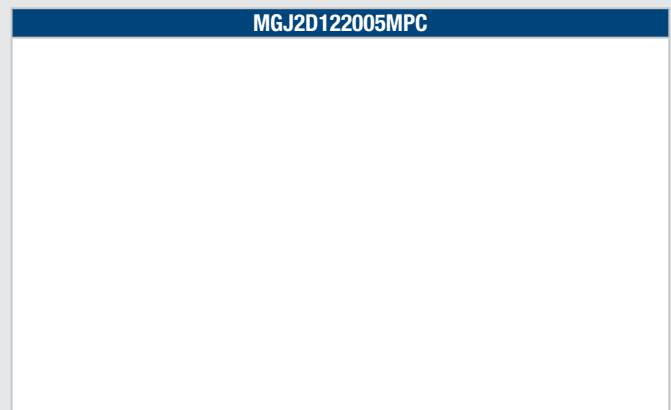
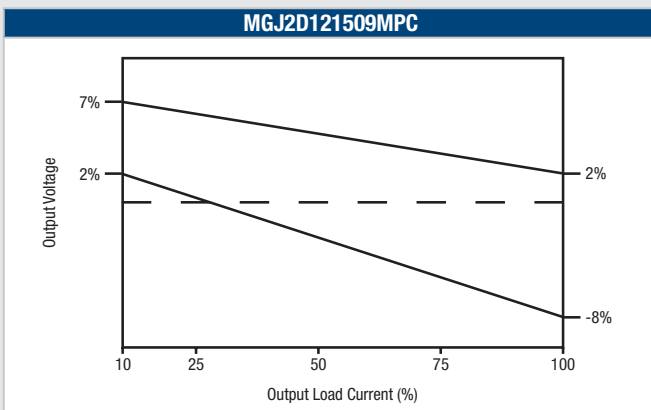
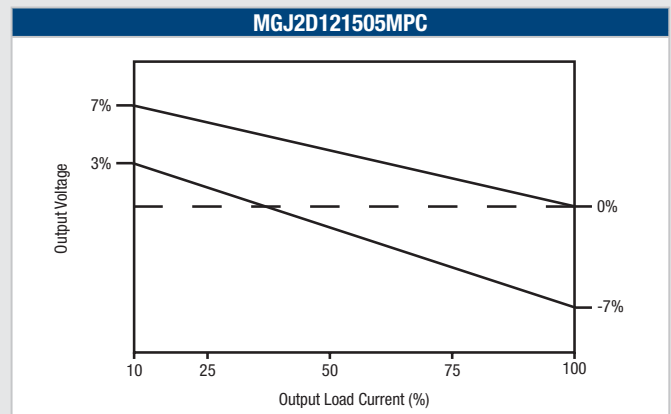
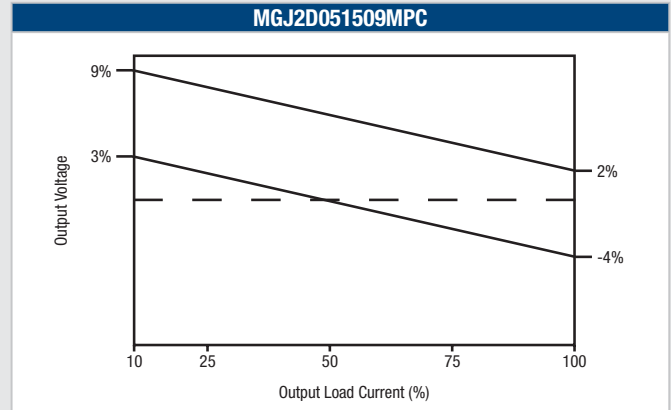
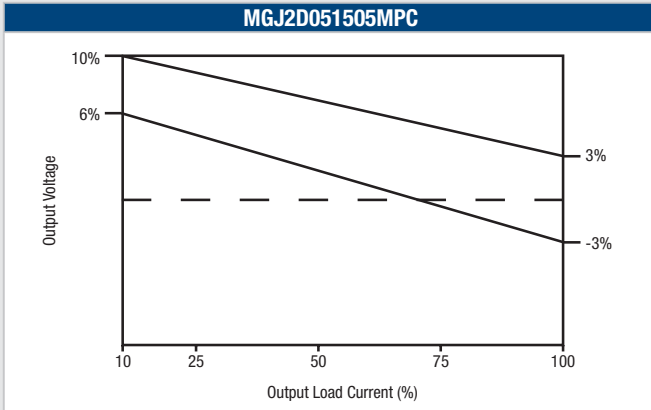



**POSITIVE OUTPUT VOLTAGE TOLERANCE ENVELOPES (continued)**

The voltage tolerance envelopes show typical load regulation characteristics for this product series. The tolerance envelope is the maximum output voltage variation due to changes in output loading and set point accuracy.

**MGJ2D151505MPC**

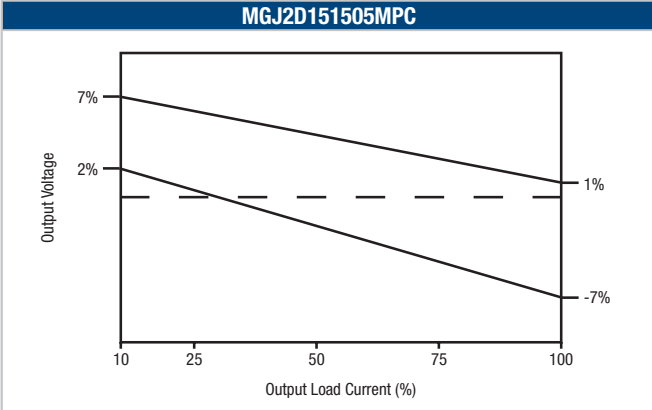

**MGJ2D151509MPC**

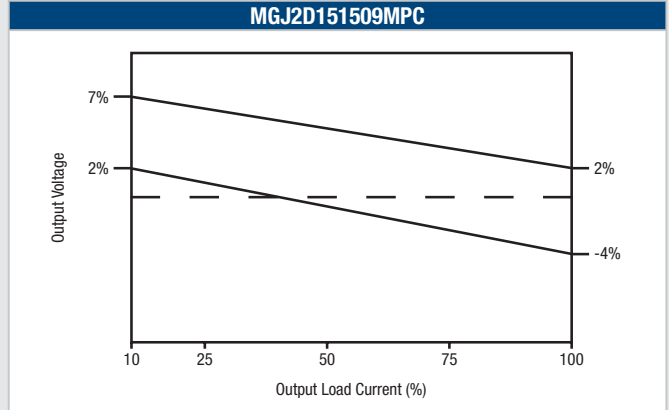

**MGJ2D152005MPC**

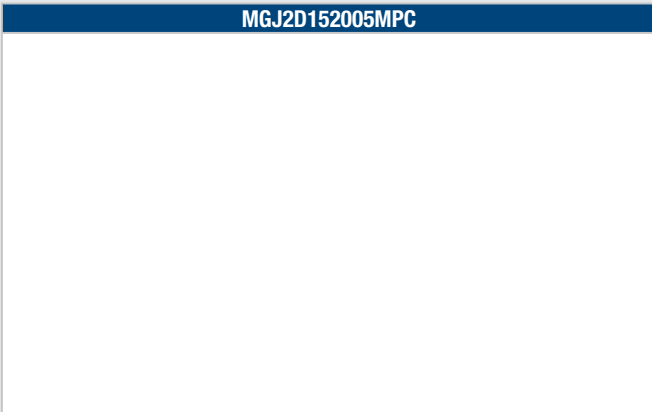

## NEGATIVE OUTPUT VOLTAGE TOLERANCE ENVELOPES

The voltage tolerance envelopes show typical load regulation characteristics for this product series. The tolerance envelope is the maximum output voltage variation due to changes in output loading and set point accuracy.

**MGJ2D051505MPC**

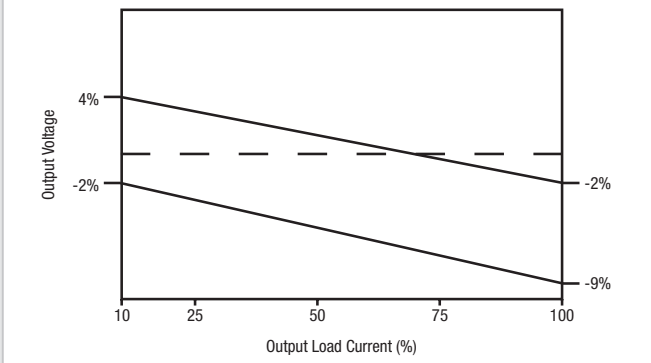

**MGJ2D051509MPC**

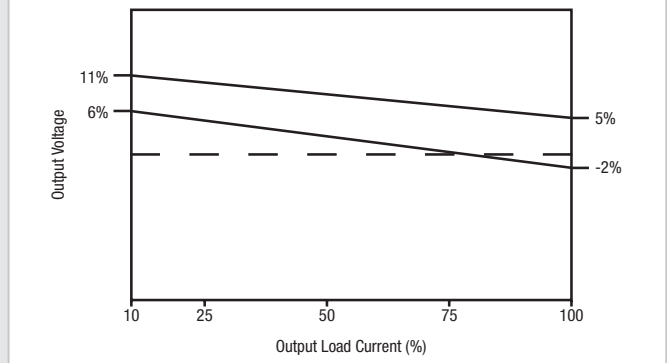

**MGJ2D052005MPC**



**MGJ2D121505MPC**

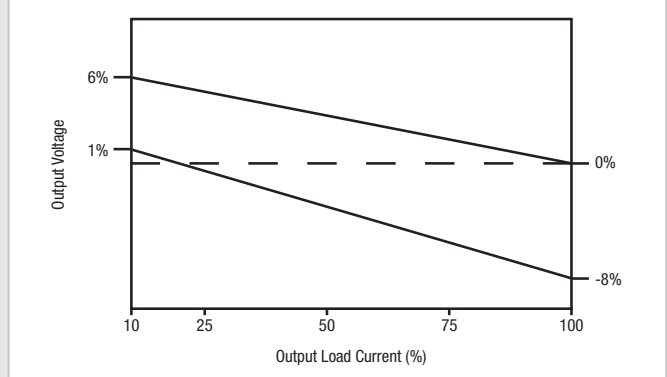

**MGJ2D121509MPC**

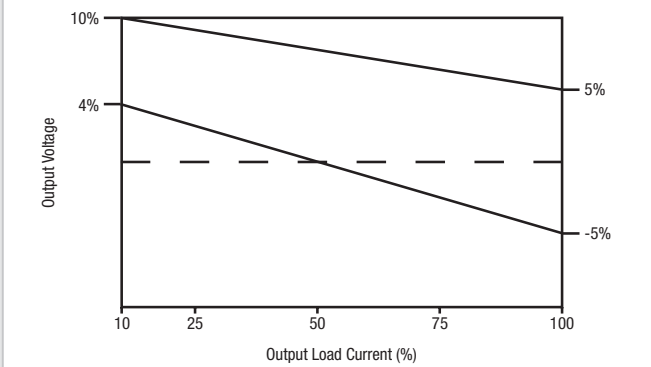

**MGJ2D122005MPC**



**NEGATIVE OUTPUT VOLTAGE TOLERANCE ENVELOPES (continued)**

The voltage tolerance envelopes show typical load regulation characteristics for this product series. The tolerance envelope is the maximum output voltage variation due to changes in output loading and set point accuracy.

**MGJ2D151505MPC**

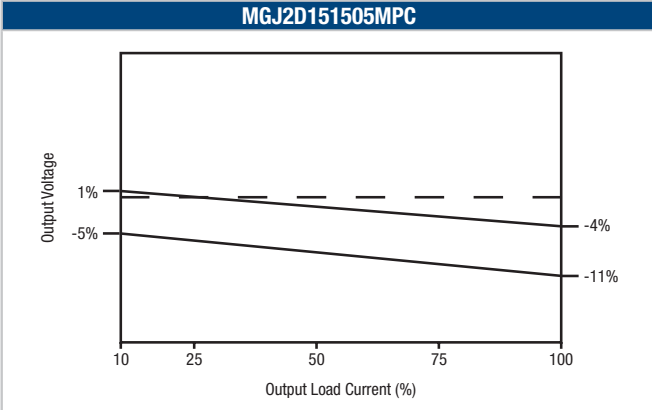

**MGJ2D151509MPC**

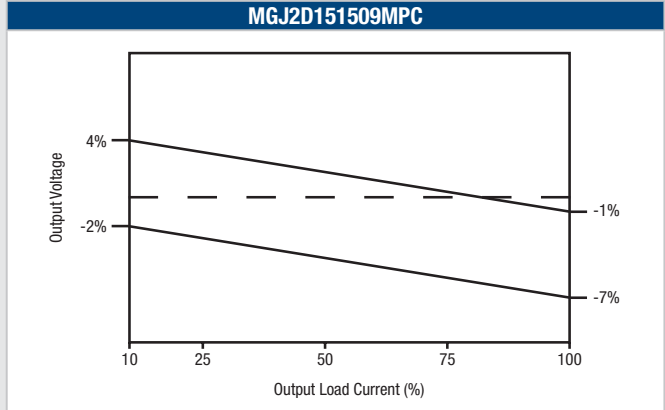

**MGJ2D152005MPC**

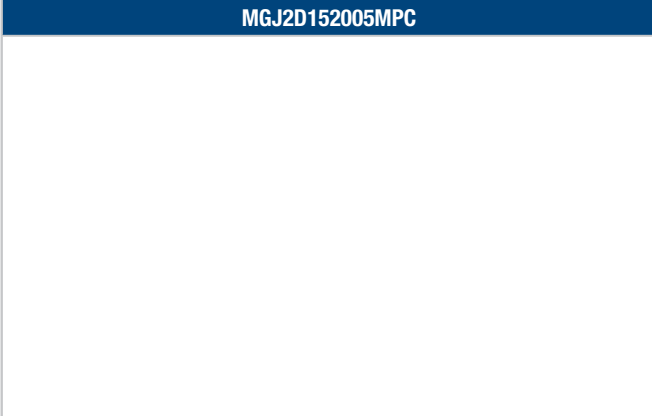

**EFFICIENCY VS LOAD**

**MGJ2D051505MPC**

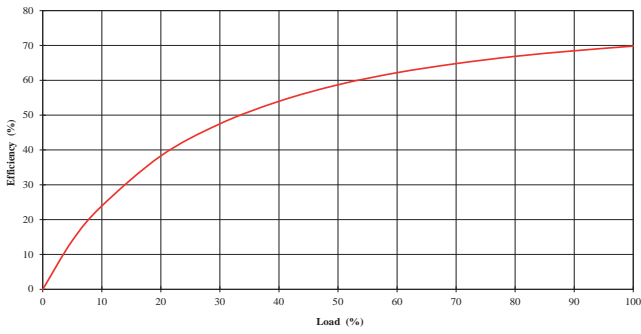

**MGJ2D051509MPC**

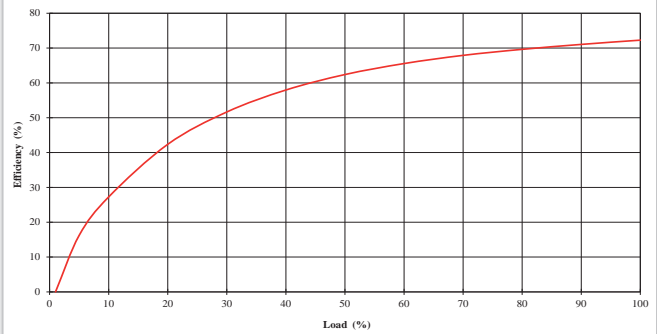

**MGJ2D052005MPC**



**MGJ2D121505MPC**

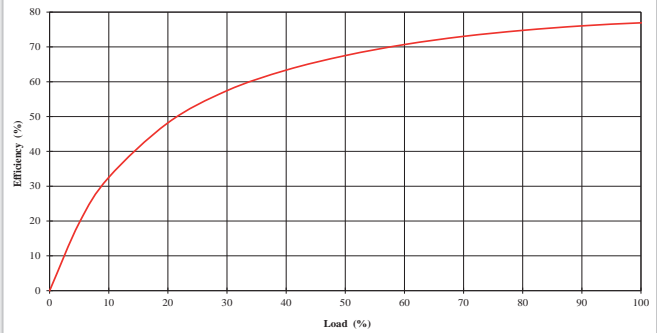

**MGJ2D121509MPC**

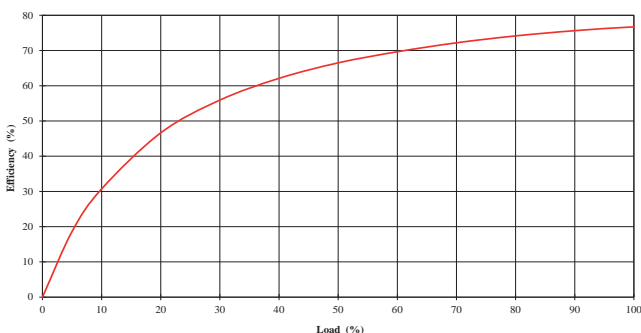

**MGJ2D122005MPC**

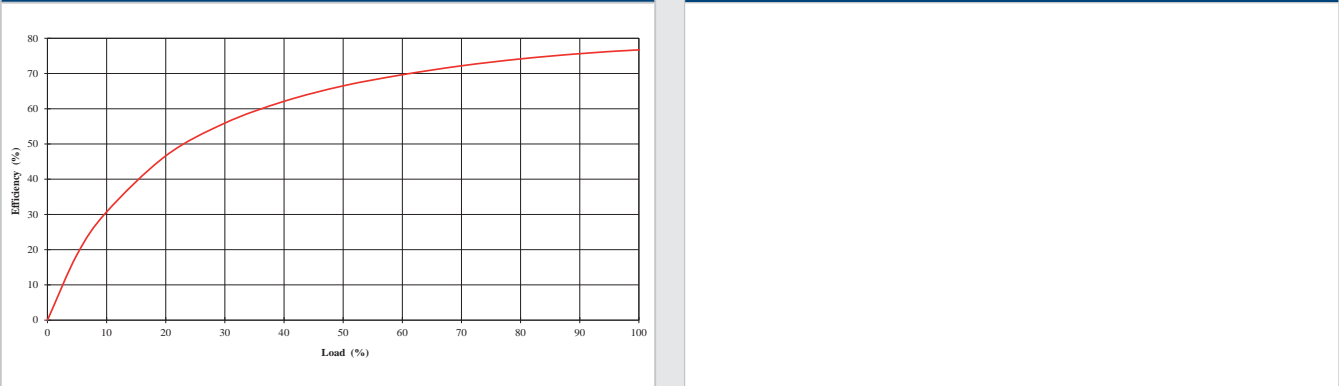

**EFFICIENCY VS LOAD**

**MGJ2D151505MPC**

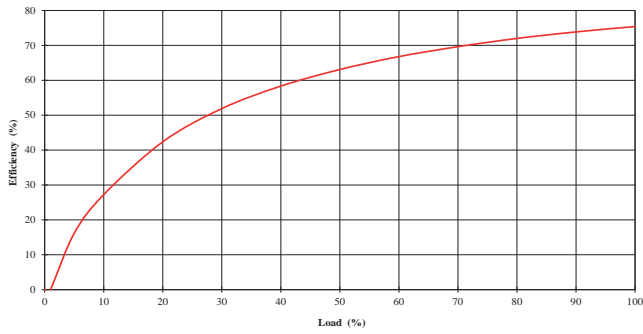

**MGJ2D151509MPC**

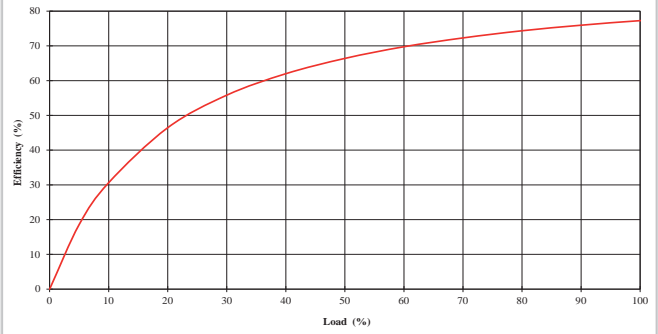

**MGJ2D152005MPC**



**TEMPERATURE DERATING**

**MGJ2D051505MPC**

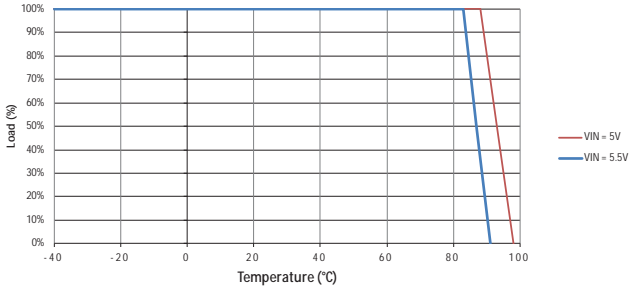

**MGJ2D051509MPC**

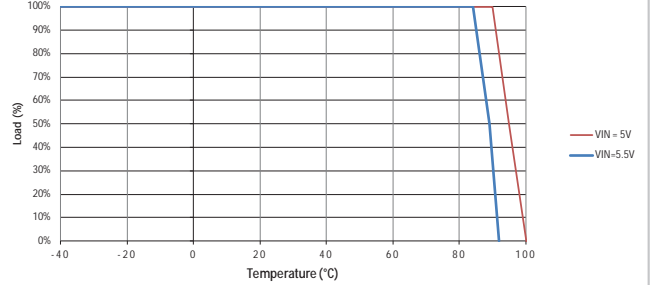

**MGJ2D052005MPC**

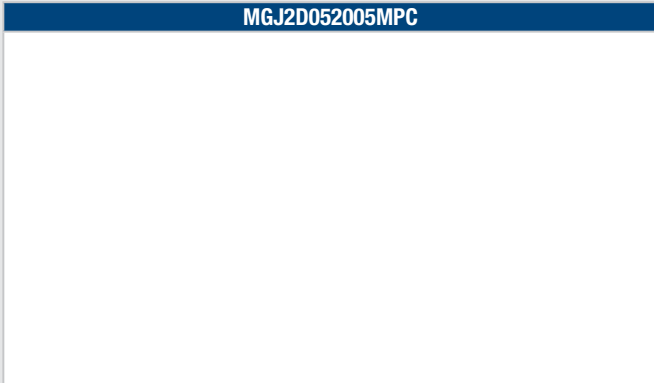

**MGJ2D121505MPC**

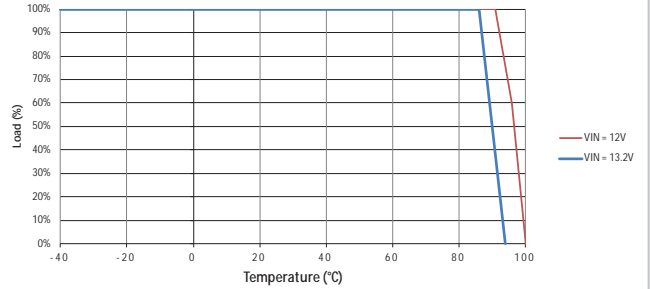

**MGJ2D121509MPC**

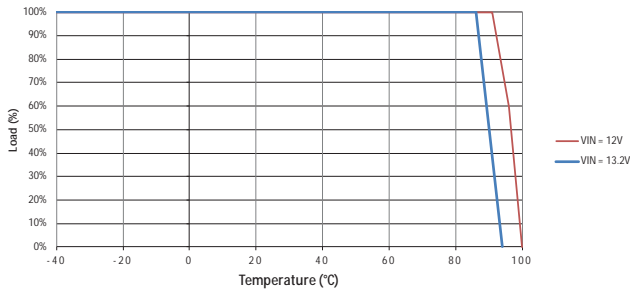

**MGJ2D122005MPC**



**TEMPERATURE DERATING**

**MGJ2D151505MPC**

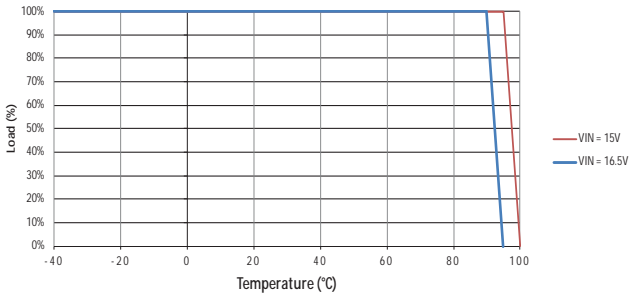

**MGJ2D151509MPC**

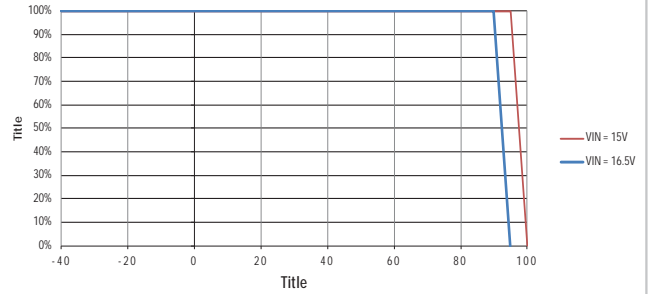

**MGJ2D152005MPC**



## EMC FILTERING AND SPECTRA

### FILTERING

The following filter circuit and filter table shows the input filters typically required to meet EN55022 Quasi-Peak Curve A or B.

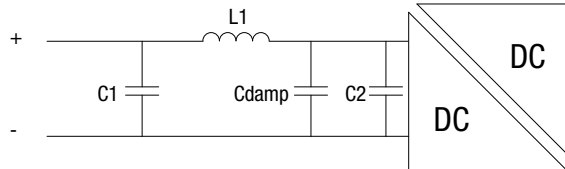

**Cdamp** Electrolytic capacitor

	Inductor			Capacitor		
	L1, $\mu$ H	SMD	Through Hole	C1&2, $\mu$ F	Part number	Cdamp, $\mu$ F
MGJ2D051505MPC	22	84223C	11R223C	10	GRM188C81C106MA73	100
MGJ2D051509MPC	22	84223C	11R223C	10	GRM188C81C106MA73	100
MGJ2D052005MPC						
MGJ2D121505MPC	22	84223C	11R223C	10	GRM188C81C106MA73	100
MGJ2D121509MPC	22	84223C	11R223C	10	GRM188C81C106MA73	100
MGJ2D122005MPC						
MGJ2D151505MPC	33	84333C	11R333C	10	GRM188C81C106MA73	100
MGJ2D151509MPC	33	84333C	11R333C	10	GRM188C81C106MA73	100
MGJ2D152005MPC						

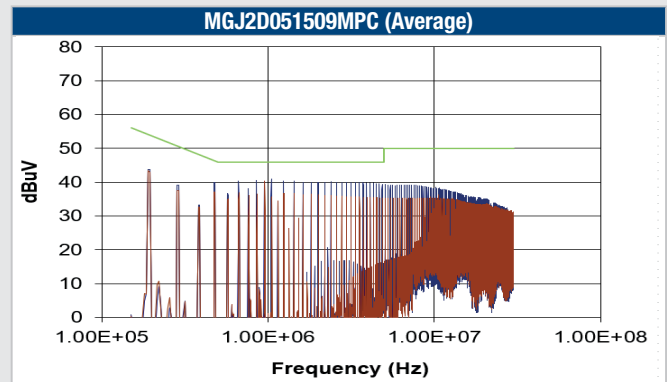
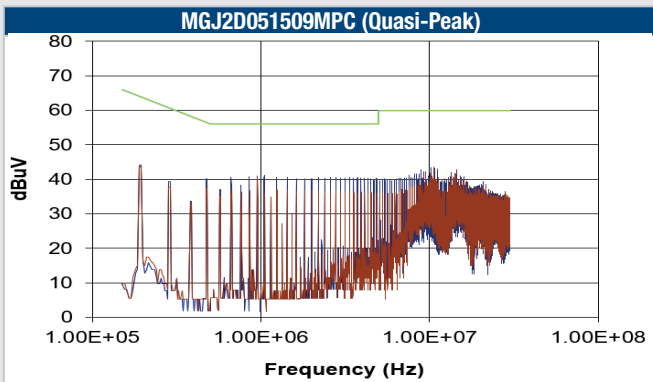
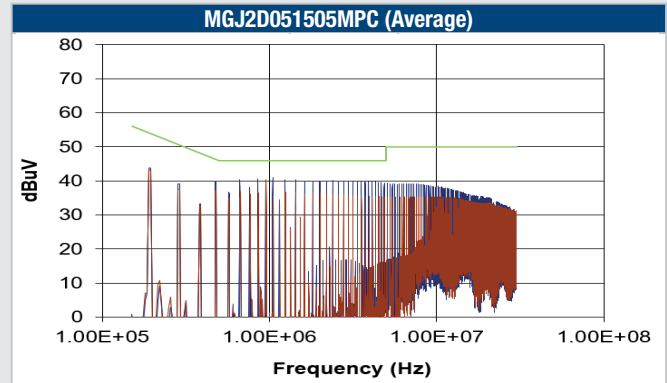
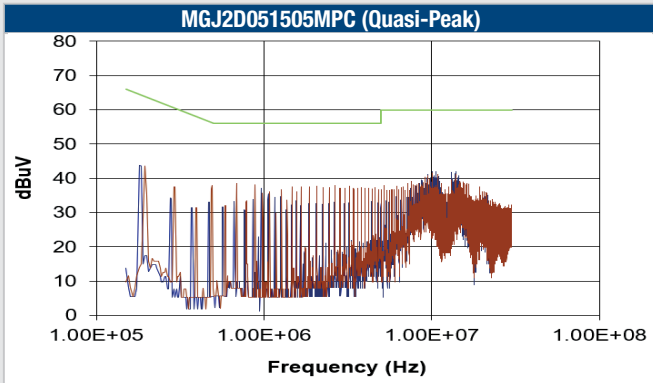



**EMC FILTERING AND SPECTRA**

**MGJ2D052005MPC (Quasi-Peak)**

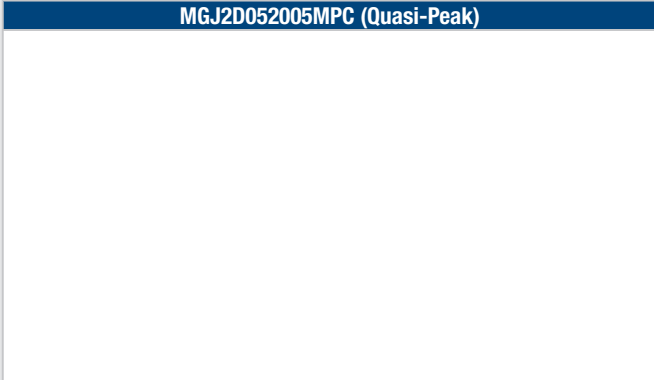

**MGJ2D052005MPC (Average)**

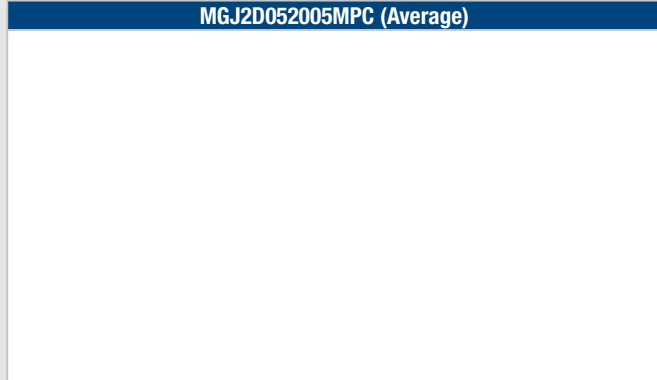

**MGJ2D121505MPC (Quasi-Peak)**

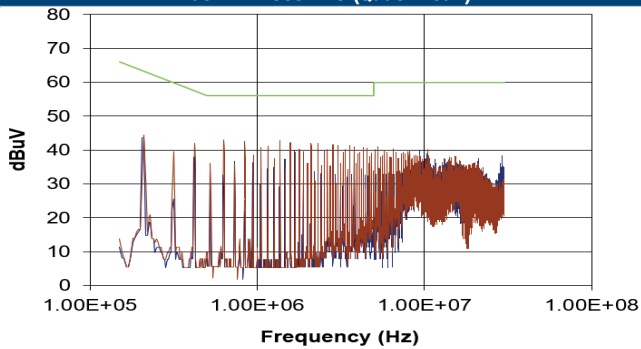

**MGJ2D121505MPC (Average)**

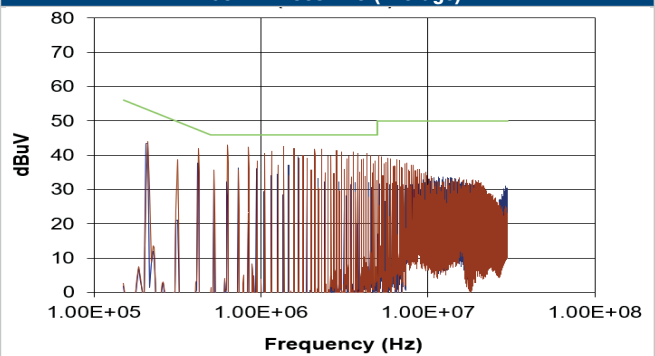

**MGJ2D121509MPC (Quasi-Peak)**

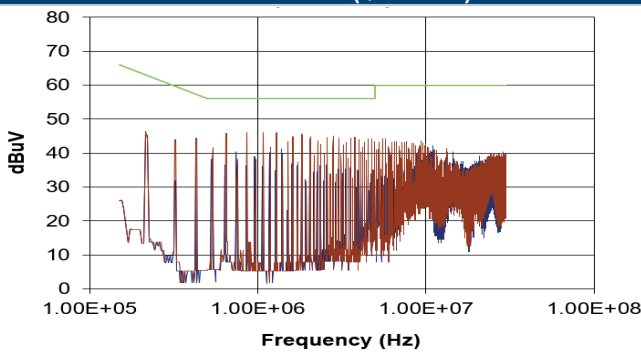

**MGJ2D121509MPC (Average)**

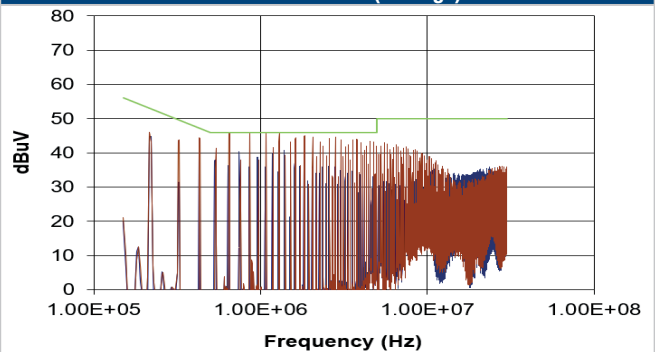

**MGJ2D122005MPC (Quasi-Peak)**

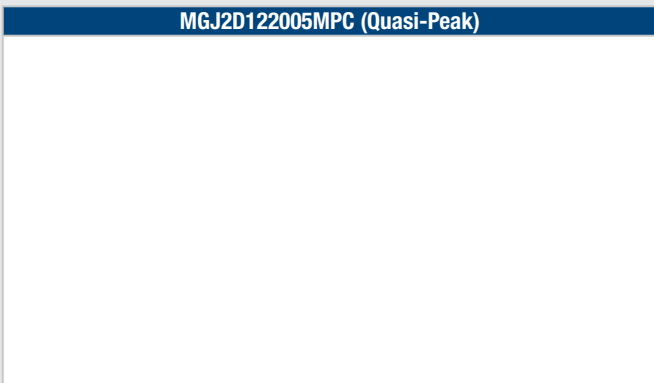

**MGJ2D122005MPC (Average)**

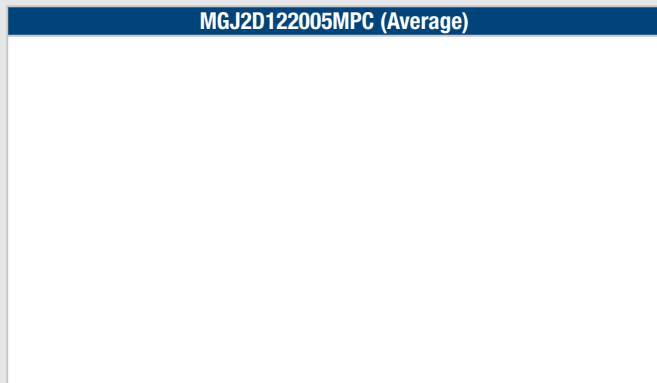

**EMC FILTERING AND SPECTRA**

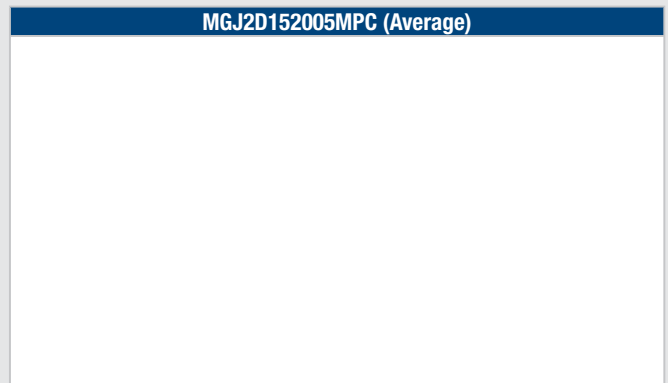
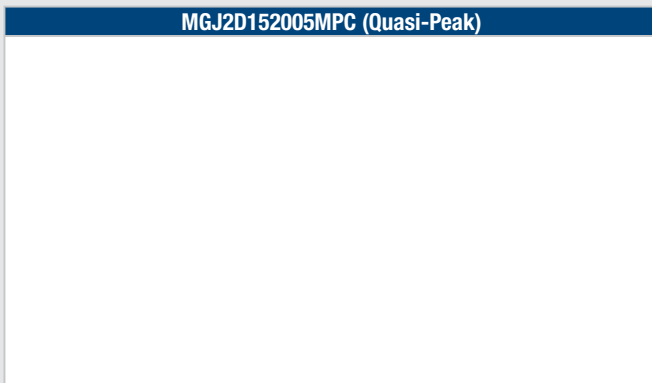
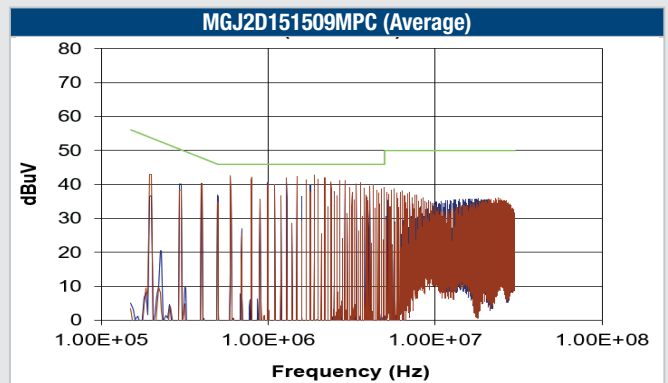
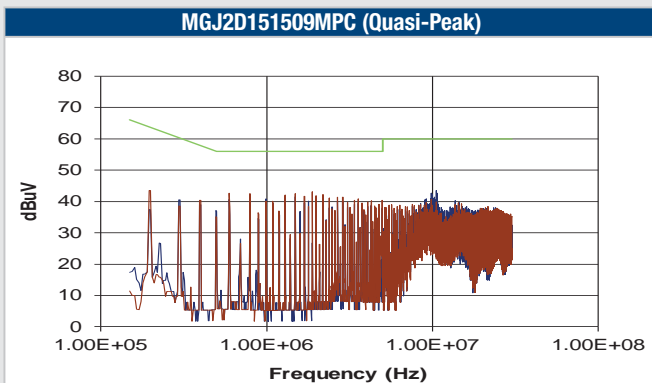
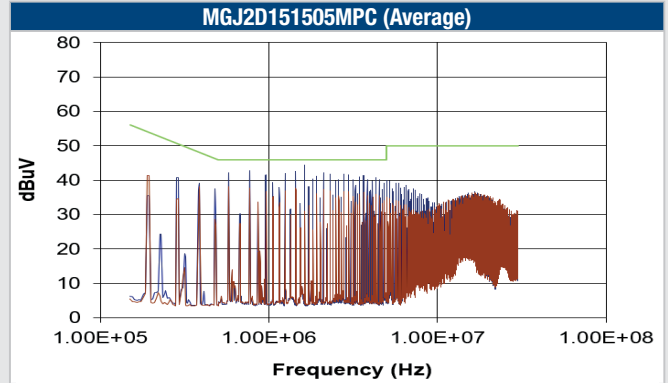
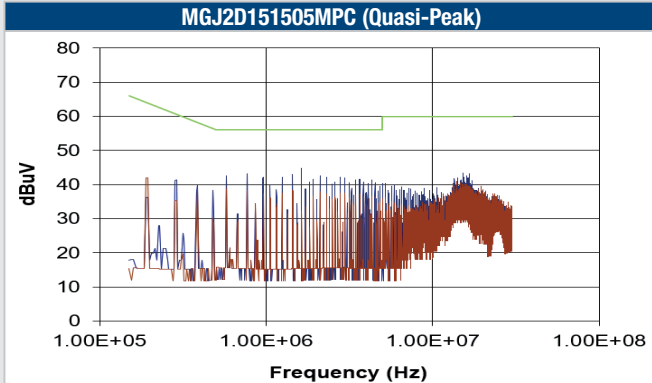

**PACKAGE SPECIFICATIONS**

**MECHANICAL DIMENSIONS**

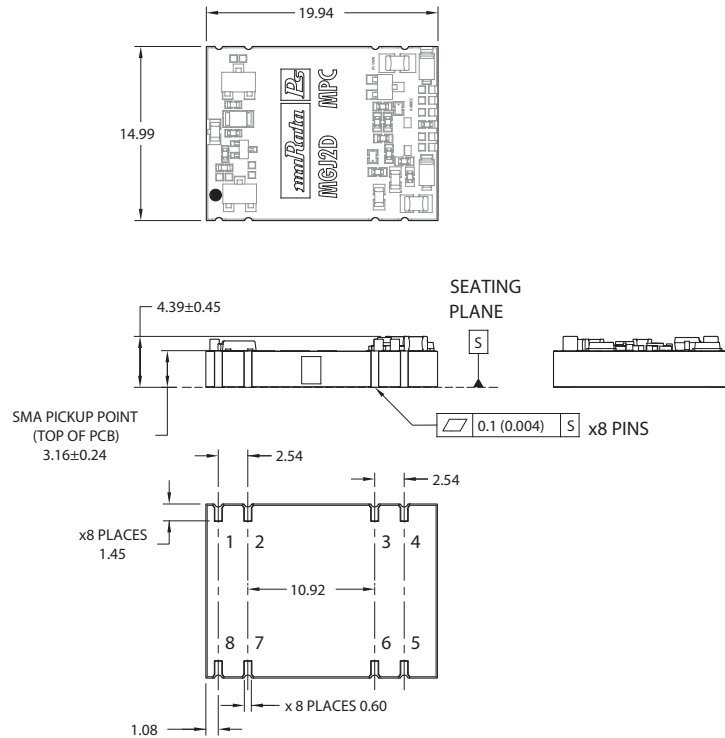

All dimensions in mm (inches). Controlling dimensions in mm.  
 Tolerance (unless otherwise stated)  $\pm 0.10$  (0.004).  
 Components shown for reference only.

Weight: 2.4g

**PIN CONNECTIONS**

Pin	Function
1	-Vin
2	NA
3	-Vout
4	-Vout
5	+Vout
6	0V
7	NC
8	+Vin

NA - Not Available for electrical connection.

**RECOMMENDED FOOTPRINT DETAILS**

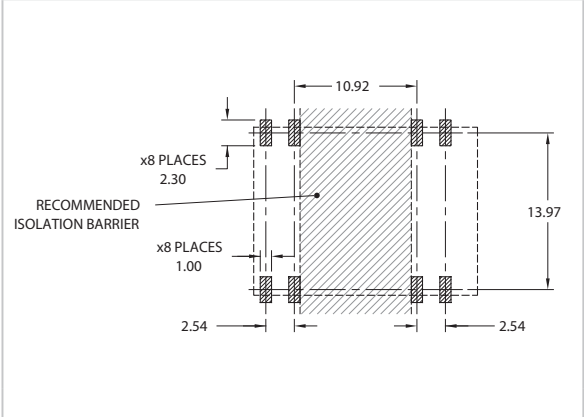

## TAPE & REEL SPECIFICATIONS

### Reel Outline Dimensions

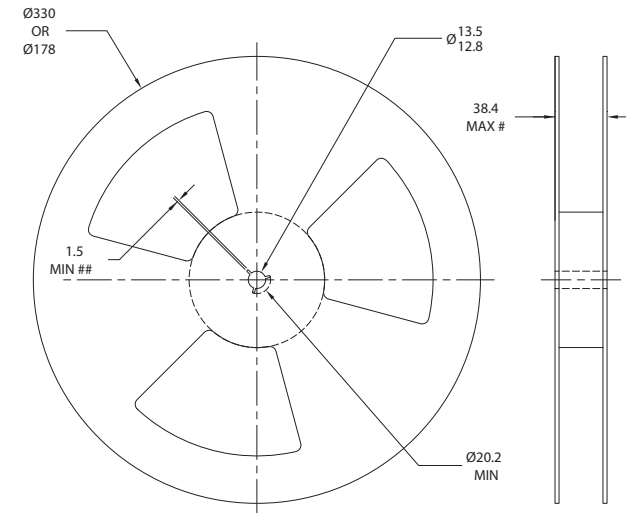

Tape & Reel specifications shall conform with current EIA-481 standard  
 Unless otherwise stated all dimensions in mm (inches)  
 Controlling dimension is mm  
 # Measured at hub  
 ## Six equi-spaced slots on 180mm/7" reel

### Reel Packaging Details

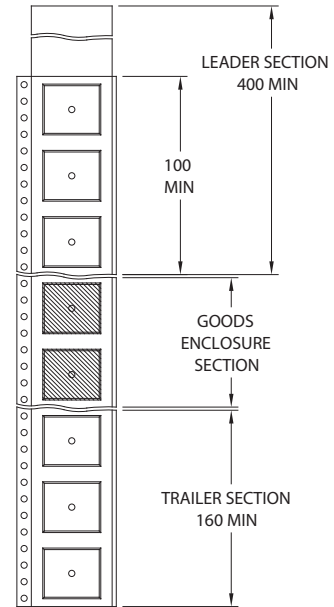

Reel Quantity: 7" - 80 or 13" - 400

### Tape Outline Dimensions

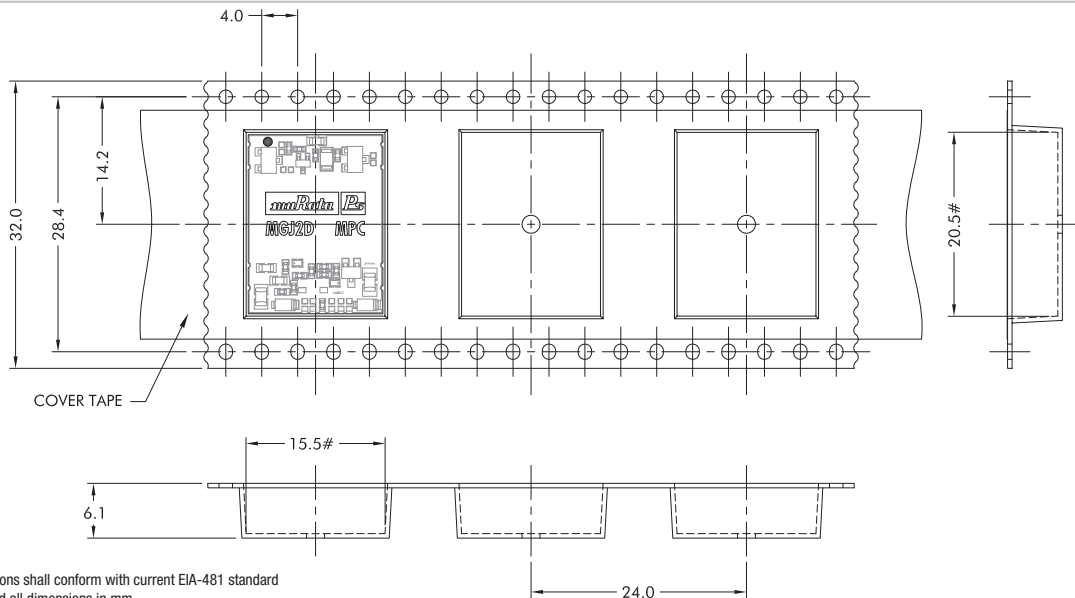

Tape & Reel specifications shall conform with current EIA-481 standard  
 Unless otherwise stated all dimensions in mm  
 Components shall be orientated within the carrier tape as indicated  
 # Measured on a plane 0.3mm above the bottom pocket

**DISCLAIMER**

Unless otherwise stated in the datasheet, all products are designed for standard commercial and industrial applications and NOT for safety-critical and/or life-critical applications.

Particularly for safety-critical and/or life-critical applications, i.e. applications that may directly endanger or cause the loss of life, inflict bodily harm and/or loss or severe damage to equipment/property, and severely harm the environment, a prior explicit written approval from Murata is strictly required. Any use of Murata standard products for any safety-critical, life-critical or any related applications without any prior explicit written approval from Murata shall be deemed unauthorised use.

These applications include but are not limited to:

- Aircraft equipment
- Aerospace equipment
- Undersea equipment
- Power plant control equipment
- Medical equipment
- Transportation equipment ( automobiles, trains, ships, etc.)
- Traffic signal equipment
- Disaster prevention / crime prevention equipment
- Data Processing equipment

Murata makes no express or implied warranty, representation, or guarantee of suitability, fitness for any particular use/purpose and/or compatibility with any application or device of the buyer, nor does Murata assume any liability whatsoever arising out of unauthorised use of any Murata product for the application of the buyer. The suitability, fitness for any particular use/purpose and/or compatibility of Murata product with any application or device of the buyer remain to be the responsibility and liability of the buyer.

Buyer represents and agrees that it has all the necessary expertise to create and implement safeguards that anticipate dangerous consequences of failures, monitor failures and their consequences, lessen the likelihood of failures that might cause harm, and take appropriate remedial actions. Buyer will fully indemnify and hold Murata, its affiliated companies, and its representatives harmless against any damages arising out of unauthorised use of any Murata products in any safety-critical and/or life-critical applications.

Remark: Murata in this section refers to Murata Manufacturing Company and its affiliated companies worldwide including, but not limited to, Murata Power Solutions.



This product is subject to the following **operating requirements** and the **Life and Safety Critical Application Sales Policy**:

Refer to: <https://www.murata.com/en-eu/products/power/requirements>

Murata Power Solution(Milton keynes) Ltd. makes no representation that the use of its products in the circuits described herein, or the use of other technical information contained herein, will not infringe upon existing or future patent rights. The descriptions contained herein do not imply the granting of licenses to make, use, or sell equipment constructed in accordance therewith. Specifications are subject to change without notice. © 2021 Murata Power Solution(Milton keynes) Ltd.