

Miniature Slide Switches

Specifications:

Contact rating:	30 V DC, 350 mA
Contact resistance:	< 20 mΩ
Insulation resistance:	> 100 MΩ at 500 V DC
Dielectric strength:	500 V, 50 Hz for the duration of 1 minute
Operating temperature:	- 20° to + 85° C
Mechanical life:	minimum 10 000 operations
Contacts:	copper alloy, silver-plated over nickel barrier
Contact timing:	non-shorting
Slide colour:	black, further colours on request
Soldering conditions:	auto-soldering – max.: 3 sec, 260° C ± 5° C

Models:	Operating positions	Length (mm)	
		A	B

MFP 120	2	11,0	6,6
MFP 130	3	15,0	10,0
MFP 140	4	18,2	13,2
MFP 150	5	21,4	16,4

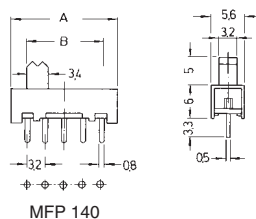

MFP 120 – R	2	11,0	6,6
MFP 130 – R	3	15,0	10,0
MFP 140 – R	4	18,2	13,2
MFP 150 – R	5	21,4	16,4

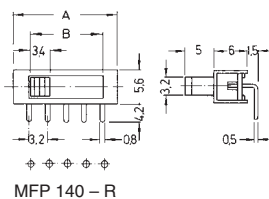

MFP 220	2	13,6	6,9
MFP 230	3	16,8	10,1
MFP 240	4	20,0	13,3
MFP 250	5	23,2	16,5
MFP 260	6	26,4	19,7

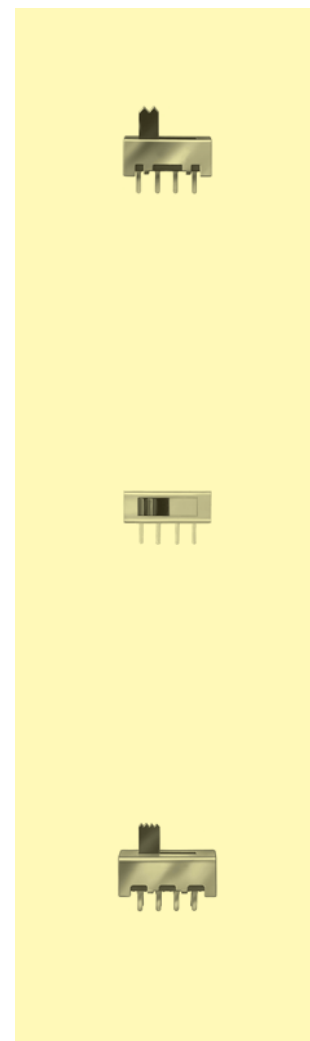
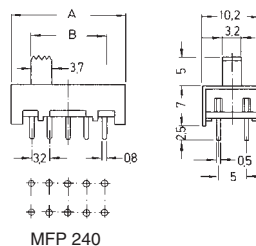
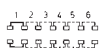



Miniature Slide Switches

Specifications:

Contact rating:	30 V DC, 350 mA
Contact resistance:	< 25 mΩ
Insulation resistance:	> 100 MΩ at 500 V DC
Dielectric strength:	500 V, 50 Hz for the duration of 1 minute
Operating temperature:	– 20° to + 85° C
Mechanical life:	minimum 10 000 operations
Contacts:	copper alloy, silver-plated over nickel barrier
Contact timing:	non-shorting
Slide colour:	black, further colours on request
Soldering conditions:	auto-soldering – max.: 10 sec, 260° C

4

Models:	Operating positions		Length (mm)	
			A	B

MFP 1370	3		20,0	7,6
MFP 1470	4		20,0	9,9
MFP 1570	5		22,0	12,2

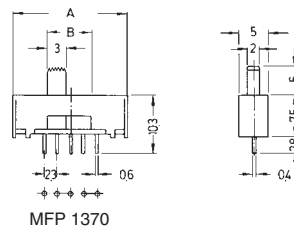

MFP 1370 – R	3		20,0	7,6
MFP 1470 – R	4		20,0	9,9
MFP 1570 – R	5		22,0	12,2

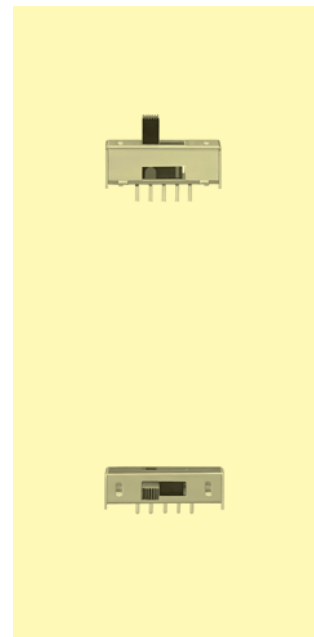
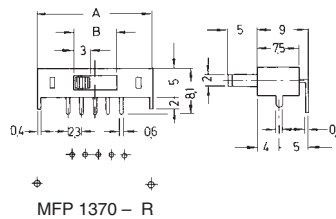

Miniature Slide Switches

Specifications:

Contact rating:	30 V DC, 350 mA
Contact resistance:	< 20 mΩ
Insulation resistance:	> 100 MΩ at 500 V DC
Dielectric strength:	500 V, 50 Hz for the duration of 1 minute
Operating temperature:	- 20° to + 85° C
Mechanical life:	minimum 10 000 operations
Contacts:	copper alloy, silver-plated over nickel barrier
Contact timing:	shorting (non-shorting only if specified)
Slide colour:	black, further colours on request
Soldering conditions:	auto-soldering – max.: 5 sec, 260° C ± 5° C

Models:	Operating positions	Length (mm)	
		A	B

MFP 1220	2	13,0	7,5
MFP 1320	3	15,5	10,0
MFP 1420	4	18,0	12,5
MFP 1520	5	20,5	15,0
MFP 1620	6	23,0	17,5

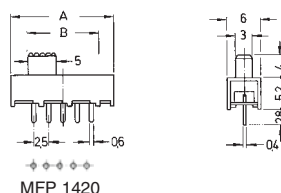

MFP 1220 – R	2	13,0	7,5
MFP 1320 – R	3	15,5	10,0
MFP 1420 – R	4	18,0	12,5
MFP 1520 – R	5	20,5	15,0
MFP 1620 – R	6	23,0	17,5

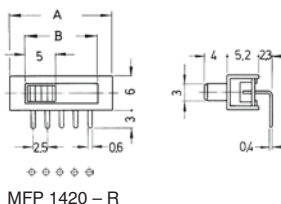
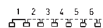

MFP 1323	3	15,5	10,0
MFP 1424	4	18,0	12,5

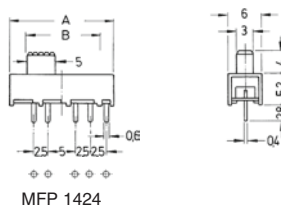
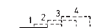

MFP 1323 – R	3	15,5	10,0
MFP 1424 – R	4	18,0	12,5

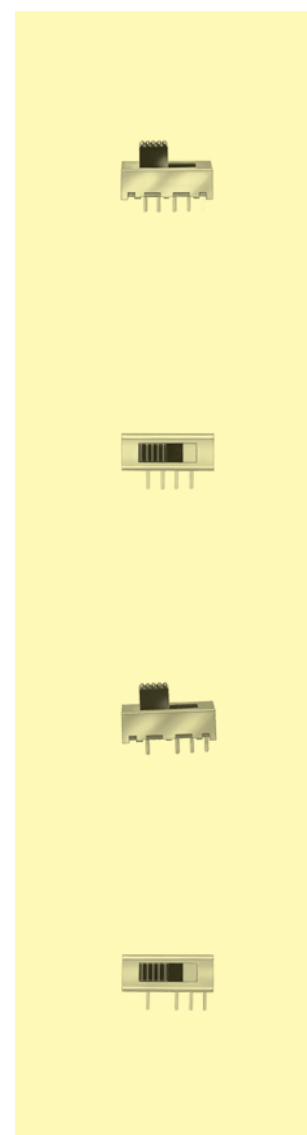
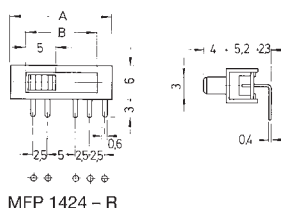
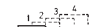



Miniature Slide Switches

Models:	Operating positions	Length (mm)	
		A	B

MFP 2220	2	13,0	7,5
MFP 2320	3	15,5	10,0
MFP 2420	4	18,0	12,5
MFP 2520	5	20,5	15,0
MFP 2620	6	23,0	17,5

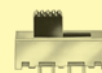
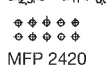
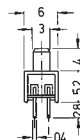
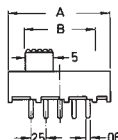

MFP 2323	3	16,0	10,0
MFP 2424	4	18,0	12,5

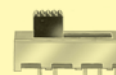
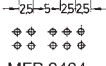
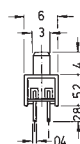
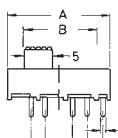

MFP 2220 - R	2	17,0	6,5
MFP 2320 - R	3	19,5	9,0

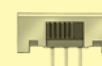
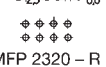
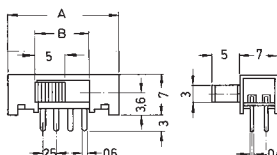

MFP 2323 - R	3	19,5	9,0
--------------	---	------	-----

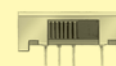
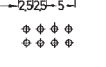
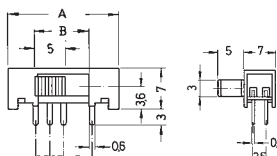

Miniature Slide Switches

Specifications: see page 102

Material: plastic housing, terminals sealed

Models: Switching functions

MFP 161 D

on on

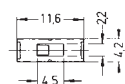
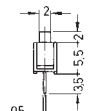
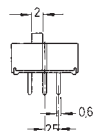

MFP 261 N

on on

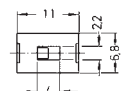
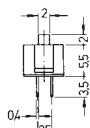
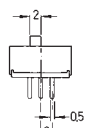

MFP 263 P

on on on

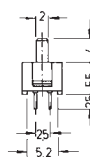
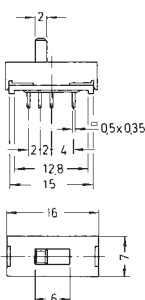

MFP 461 N
non-shorting

on on

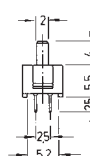
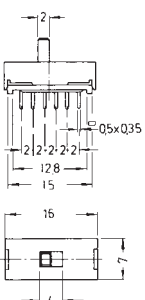

MFP 661 N

on on

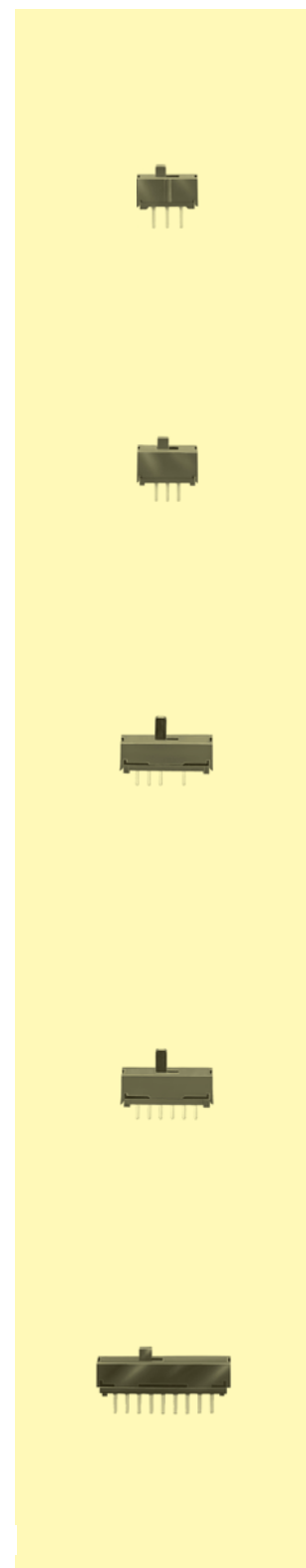
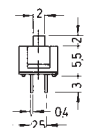
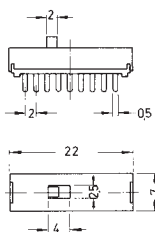



Miniature Slide Switches

Specifications: see page 102

Material: plastic housing, terminals sealed

Models: Switching functions

MFP 261 N – RA on on

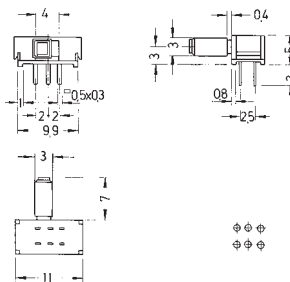

MFP 263 P – RA on on on

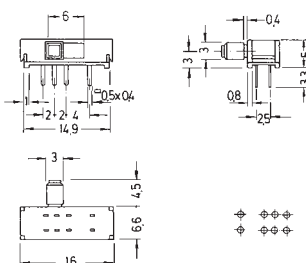

MFP 461 N – RA on on non-shorting

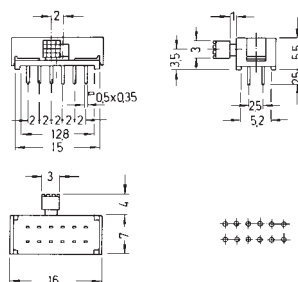

Miniature Slide Switches

Specifications:

Contact rating:	12 V DC, 100 mA
Contact resistance:	< 20 mΩ
Insulation resistance:	> 100 MΩ at 500 V DC
Dielectric strength:	500 V, 50 Hz for the duration of 1 minute
Operating temperature:	- 20° to + 85° C
Mechanical life:	minimum 10 000 operations
Contacts:	copper alloy, silver-plated over nickel barrier
Slide colour:	black, further colours on request
Soldering conditions:	auto-soldering – max.: 5 sec, 260° C ± 5° C

Models:

Switching functions

MFP 113 D
non-shorting

on on

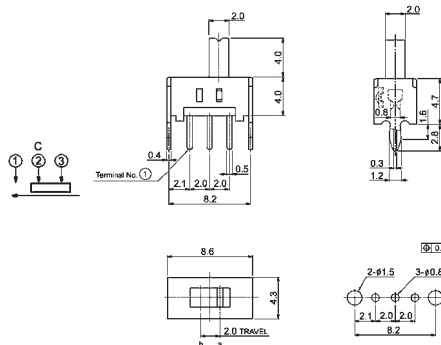

MFP 213 N
non-shorting

on on

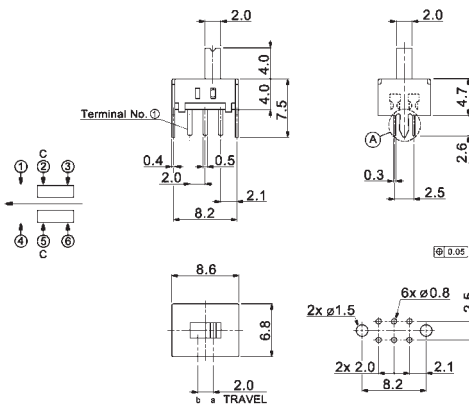

MFP 213 P
shorting

on on on

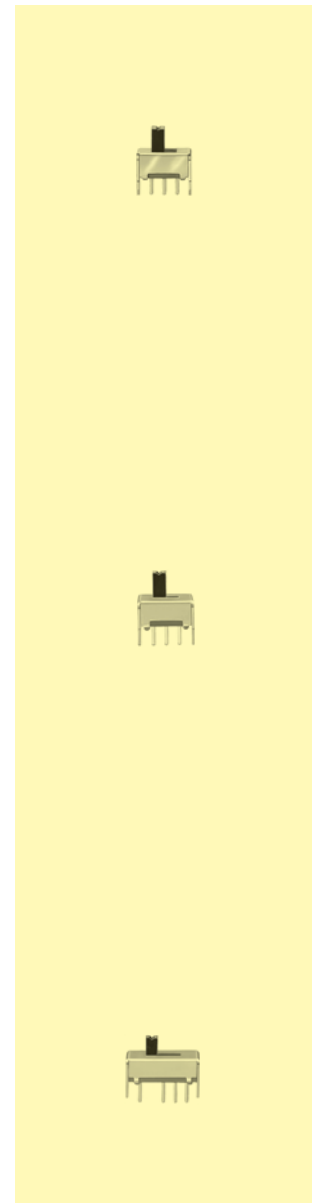
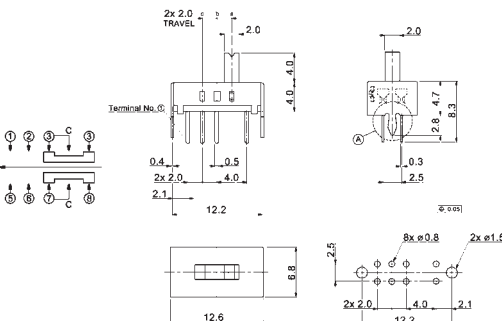



Miniature Slide Switches

Specifications:

Contact rating:	12 V DC, 100 mA
Contact resistance:	< 20 mΩ
Insulation resistance:	> 100 MΩ at 500 V DC
Dielectric strength:	500 V, 50 Hz for the duration of 1 minute
Operating temperature:	- 20° to + 85° C
Mechanical life:	minimum 10 000 operations
Contacts:	copper alloy, silver-plated over nickel barrier
Slide colour:	black, further colours on request
Soldering conditions:	auto-soldering – max.: 5 sec, 260° C ± 5° C

Models: Switching functions

MFP 113 D – RA on on
non-shorting

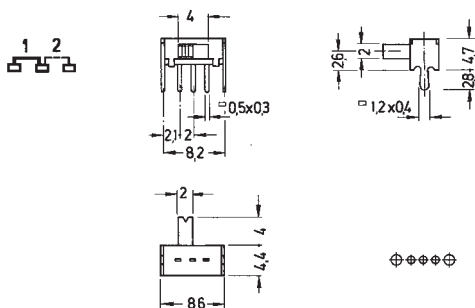

MFP 213 N – RA on on
non-shorting

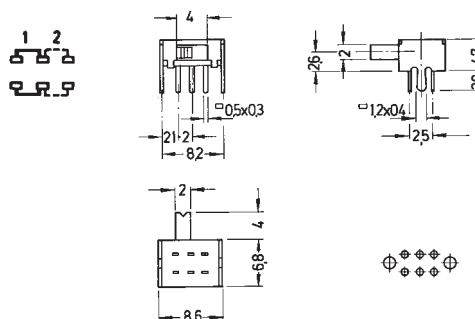

MFP 213 P – RA on on on
shorting

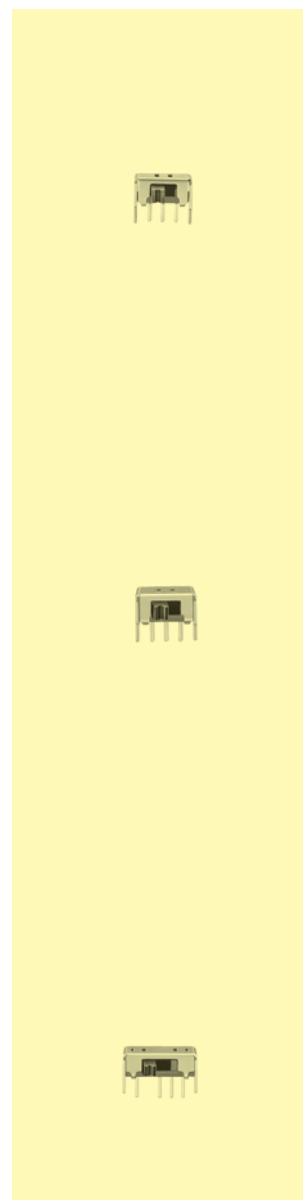
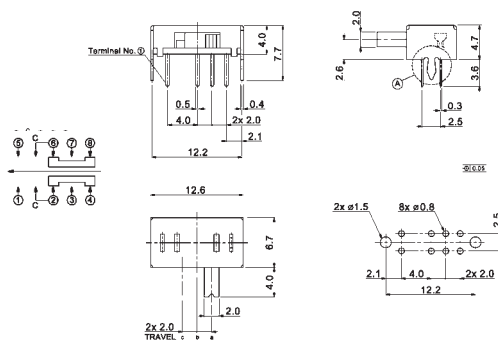

Miniature Slide Switches



Specifications:

Contact rating:	30 V DC, 350 mA
Contact resistance:	< 20 mΩ
Insulation resistance:	> 100 MΩ at 500 V DC
Dielectric strength:	500 V, 50 Hz for the duration of 1 minute
Operating temperature:	- 20° to + 85° C
Mechanical life:	minimum 10 000 operations
Contacts:	copper alloy, silver-plated over nickel barrier
Contact timing:	non-shorting
Slide colour:	black, further colours on request
Soldering conditions:	auto-soldering – max.: 5 sec, 260° C ± 5° C

Models: Switching functions

MFP 102 D on on

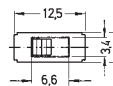
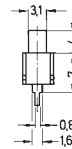
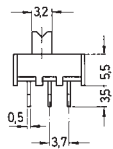

MFP 191 D on on

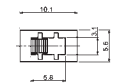
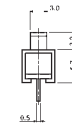
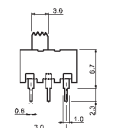

MFP 201 N on on

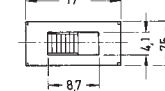
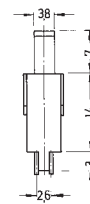
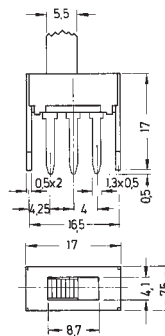

MFP 211 N on on

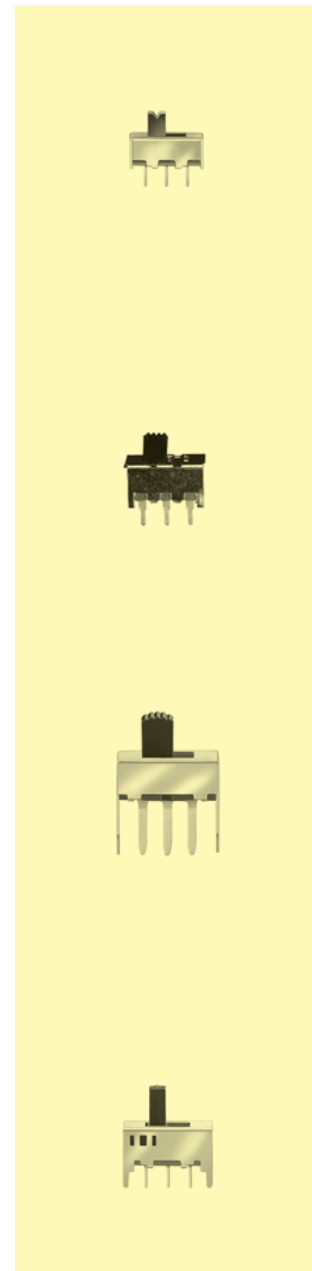
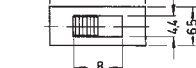
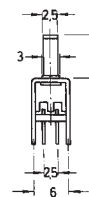
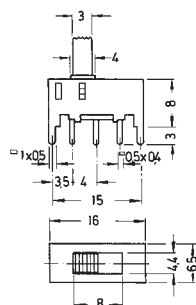



Miniature Slide Switches

Specifications:

Contact rating:	30 V DC, 350 mA
Contact resistance:	< 20 mΩ
Insulation resistance:	> 100 MΩ at 500 V DC; MFPP 130 – RA: 250 V DC
Dielectric strength:	500 V, 50 Hz for the duration of 1 minute
Operating temperature:	– 20° to + 85° C
Mechanical life:	minimum 10 000 operations; MFPP 130 – RA > 100 000
Contacts:	copper alloy, silver-plated over nickel barrier
Slide colour:	black, further colours on request
Soldering conditions:	auto-soldering – max.: 5 sec, 260° C ± 5° C

Models: Switching functions

MFP 121 D – RA on on

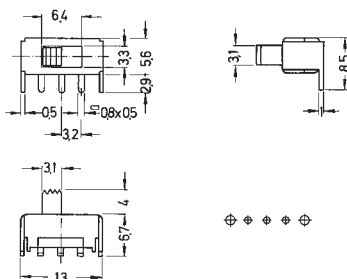

non-shorting

MFP 201 N – RA on on

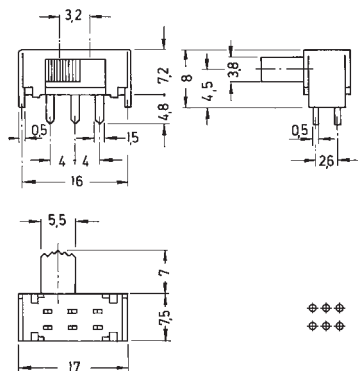

non-shorting

Miniature Slide Switches/ Pushbutton Switches

MFPP 130 – RA on on on

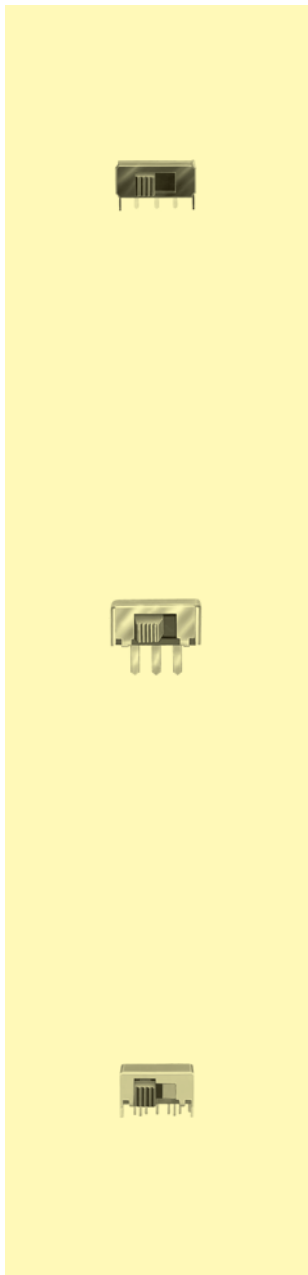
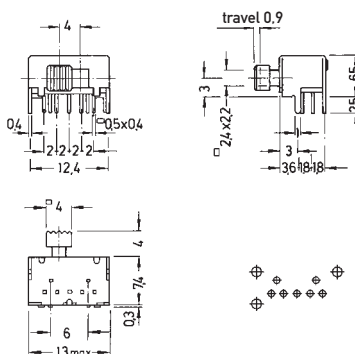

Miniature Slide Switches

Specifications:

Contact rating:	30 V DC, 350 mA
Contact resistance:	< 20 mΩ
Insulation resistance:	> 100 MΩ at 500 V DC
Dielectric strength:	500 V, 50 Hz for the duration of 1 minute
Operating temperature:	- 20° to + 85° C
Mechanical life:	minimum 10 000 operations
Contacts:	copper alloy, silver-plated over nickel barrier
Slide colour:	black, further colours on request
Soldering conditions:	auto-soldering – max.: 5 sec, 260° C ± 5° C

Models: Switching functions

MFP 221 N
non-shorting

on on

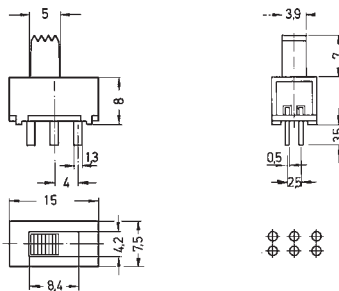

MFP 223 P
shorting

on on on

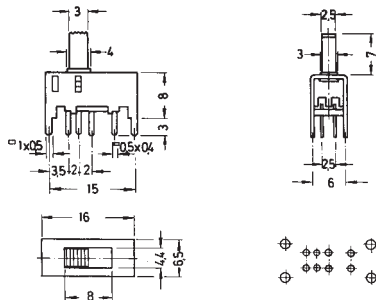

MFP 231 P
shorting

on on on

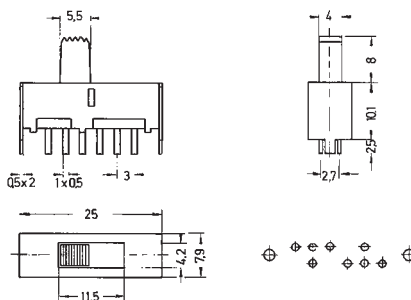

MFP 291 N
non-shorting

on on

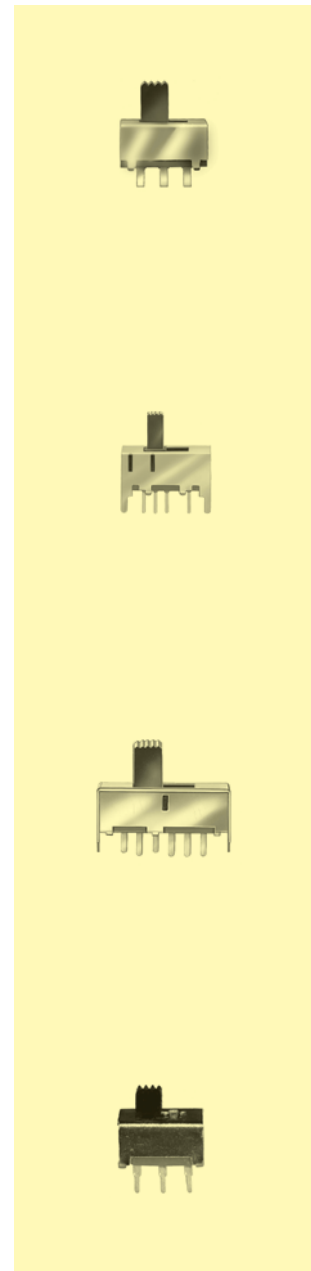
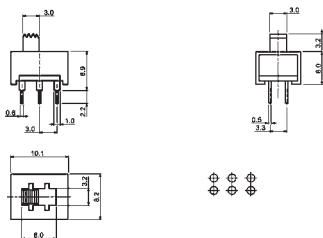



Miniature Slide Switches

Specifications:

Contact rating:	30 V DC, 350 mA
Contact resistance:	< 20 mΩ
Insulation resistance:	> 100 MΩ at 500 V DC
Dielectric strength:	500 V, 50 Hz for the duration of 1 minute
Operating temperature:	- 20° to + 85° C
Mechanical life:	minimum 10 000 operations
Contacts:	copper alloy, silver-plated over nickel barrier
Slide colour:	black, further colours on request
Soldering conditions:	hand-soldering – max.: 5 sec, 270° C

Models:

Switching functions

MFS 121 D
non-shorting

on on

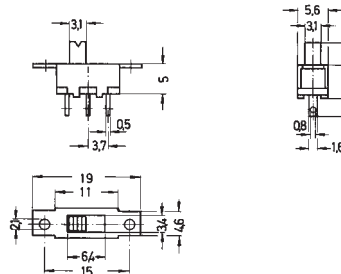

MFS 131 D
non-shorting

on on

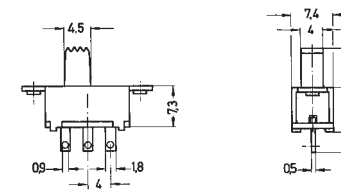

MFS 201 N
non-shorting

on on

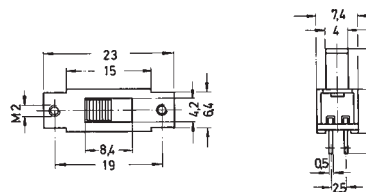

MFS 231 P
shorting

on on on

