

# Miniature Slide Switches

## Specifications:

Contact rating:	30 V DC, 350 mA
Contact resistance:	< 20 mΩ
Insulation resistance:	> 100 MΩ at 500 V DC
Dielectric strength:	500 V, 50 Hz for the duration of 1 minute
Operating temperature:	- 10° to + 70° C
Mechanical life:	minimum 10 000 operations
Contacts:	copper alloy, silver-plated over nickel barrier
Contact timing:	non-shorting
Slide colour:	black, further colours on request
Soldering conditions:	auto-soldering – max.: 3 sec, 260° C ± 5° C

Models:	Operating positions	Length (mm)	
		A	B

MFP 120	2	11,0	6,6
MFP 130	3	15,0	10,0
MFP 140	4	18,2	13,2
MFP 150	5	21,4	16,4

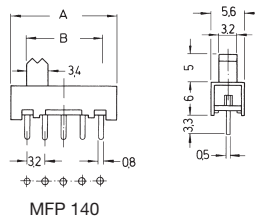

MFP 140

MFP 120 – R	2	11,0	6,6
MFP 130 – R	3	15,0	10,0
MFP 140 – R	4	18,2	13,2
MFP 150 – R	5	21,4	16,4

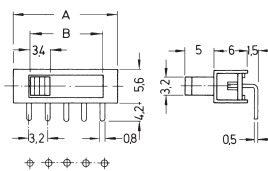

MFP 140 – R

MFP 220	2	13,6	6,9
MFP 230	3	16,8	10,1
MFP 240	4	20,0	13,3
MFP 250	5	23,2	16,5
MFP 260	6	26,4	19,7

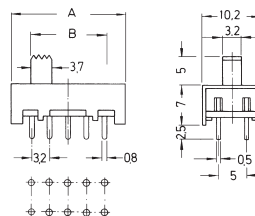
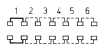

MFP 240

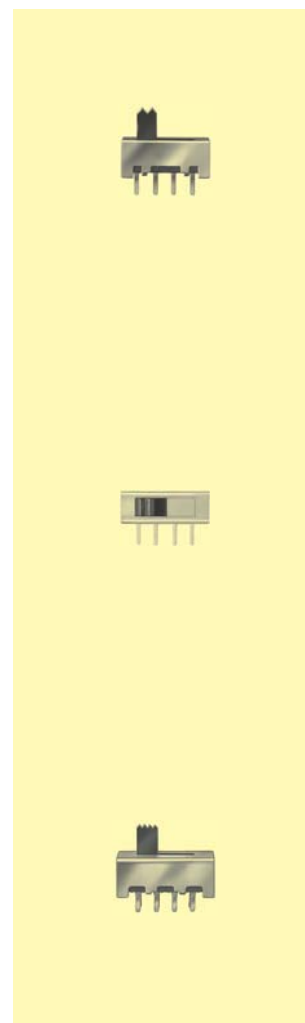



# Miniature Slide Switches

## Specifications:

Contact rating:	30 V DC, 350 mA
Contact resistance:	< 25 mΩ
Insulation resistance:	> 100 MΩ at 500 V DC
Dielectric strength:	500 V, 50 Hz for the duration of 1 minute
Mechanical life:	minimum 10 000 operations
Contacts:	copper alloy, silver-plated over nickel barrier
Contact timing:	non-shorting
Slide colour:	black, further colours on request
Soldering conditions:	auto-soldering – max.: 10 sec, 260° C

Models:	Operating positions	Length (mm)	
		A	B

MFP 1370	3	20,0	7,6
MFP 1470	4	20,0	9,9
MFP 1570	5	22,0	12,2

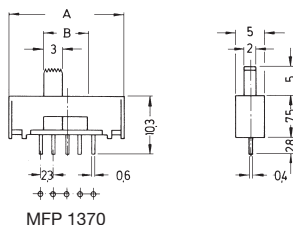

MFP 1370

MFP 1370 – R	3	20,0	7,6
MFP 1470 – R	4	20,0	9,9
MFP 1570 – R	5	22,0	12,2

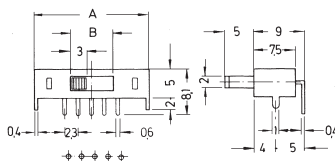

MFP 1370 – R

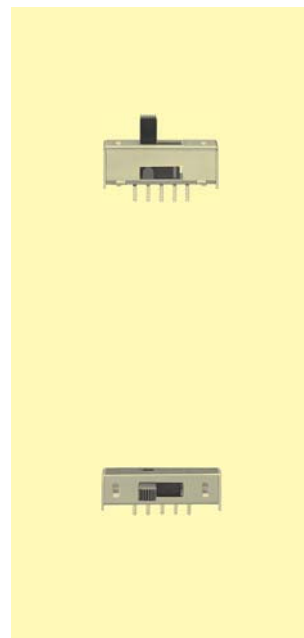

# Miniature Slide Switches



## Specifications:

Contact rating:	30 V DC, 350 mA
Contact resistance:	< 20 mΩ
Insulation resistance:	> 100 MΩ at 500 V DC
Dielectric strength:	500 V, 50 Hz for the duration of 1 minute
Mechanical life:	minimum 10 000 operations
Contacts:	copper alloy, silver-plated over nickel barrier
Contact timing:	shorting (non-shorting only if specified)
Slide colour:	black, further colours on request
Soldering conditions:	auto-soldering – max.: 5 sec, 260° C ± 5° C

Models:	Operating positions	Length (mm)	
		A	B

MFP 1220	2	13,0	7,5
MFP 1320	3	15,5	10,0
MFP 1420	4	18,0	12,5
MFP 1520	5	20,5	15,0
MFP 1620	6	23,0	17,5

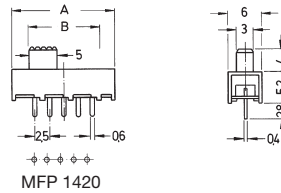
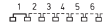

MFP 1220 – R	2	13,0	7,5
MFP 1320 – R	3	15,5	10,0
MFP 1420 – R	4	18,0	12,5
MFP 1520 – R	5	20,5	15,0
MFP 1620 – R	6	23,0	17,5

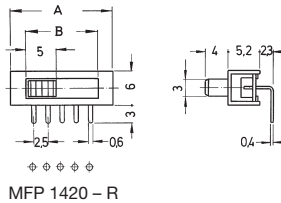
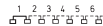

MFP 1323	3	15,5	10,0
MFP 1424	4	18,0	12,5

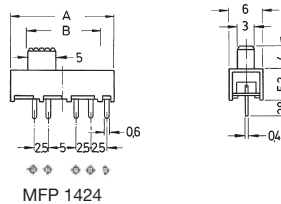

MFP 1323 – R	3	15,5	10,0
MFP 1424 – R	4	18,0	12,5

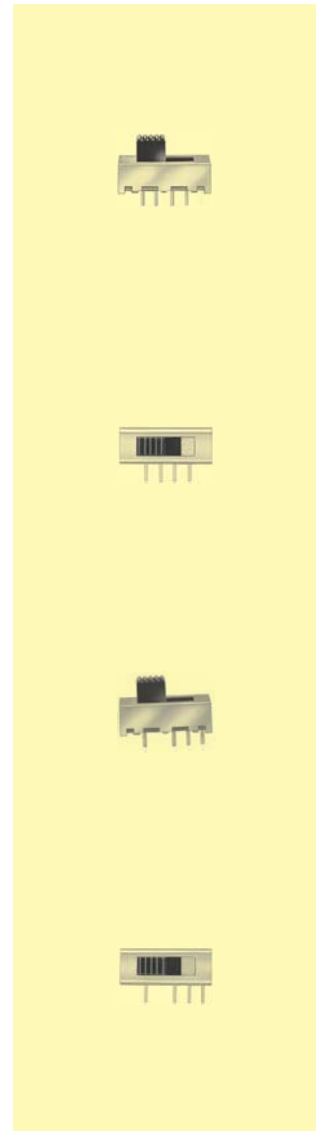
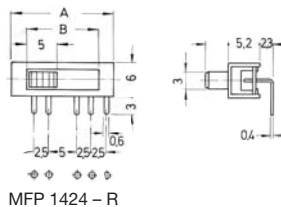



# Miniature Slide Switches



**Specifications:** see page 102

**Material:** plastic housing, terminals sealed

**Models:** Switching functions

MFP 161 D

on on

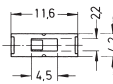
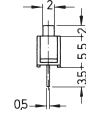
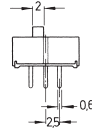

MFP 261 N

on on

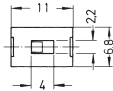
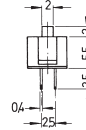
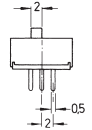

MFP 263 P

on on on

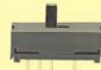
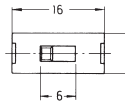
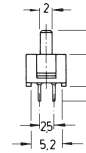
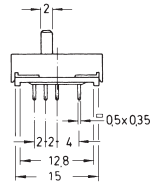

MFP 461 N  
non-shorting

on on

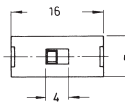
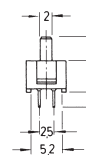
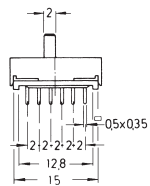

MFP 661 N

on on

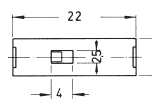
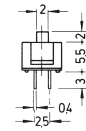
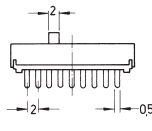
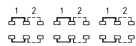



# Miniature Slide Switches

**Specifications:** see page 102

**Material:** plastic housing, terminals sealed

**Models:** Switching functions

MFP 261 N – RA on on

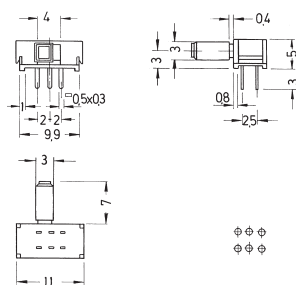

MFP 263 P – RA on on on

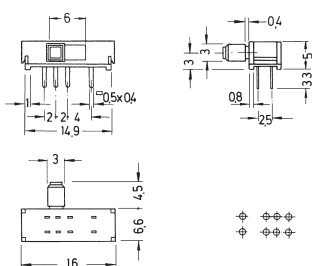

MFP 461 N – RA on on non-shorting

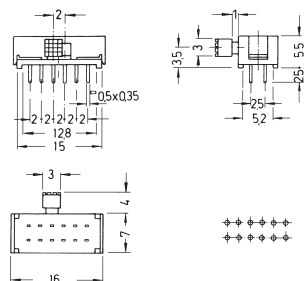

# Miniature Slide Switches

## Specifications:

Contact rating:	12 V DC, 100 mA
Contact resistance:	< 20 mΩ
Insulation resistance:	> 100 MΩ at 500 V DC
Dielectric strength:	500 V, 50 Hz for the duration of 1 minute
Mechanical life:	minimum 10 000 operations
Contacts:	copper alloy, silver-plated over nickel barrier
Slide colour:	black, further colours on request
Soldering conditions:	auto-soldering – max.: 5 sec, 260° C ± 5° C

## Models: Switching functions

MFP 113 D  
non-shorting

on on

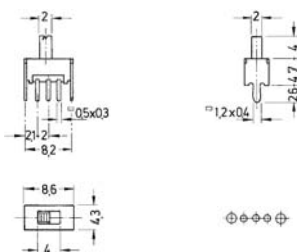

MFP 213 N  
non-shorting

on on

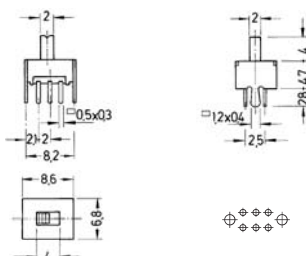

MFP 213 P  
shorting

on on on

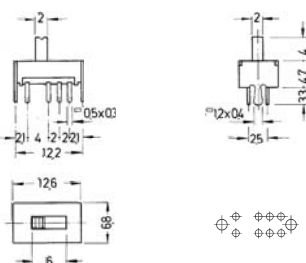



# Miniature Slide Switches

## Specifications:

Contact rating:	12 V DC, 100 mA
Contact resistance:	< 20 mΩ
Insulation resistance:	> 100 MΩ at 500 V DC
Dielectric strength:	500 V, 50 Hz for the duration of 1 minute
Mechanical life:	minimum 10 000 operations
Contacts:	copper alloy, silver-plated over nickel barrier
Slide colour:	black, further colours on request
Soldering conditions:	auto-soldering – max.: 5 sec, 260° C ± 5° C

## Models:            Switching functions

MFP 113 D – RA    on    on  
non shorting

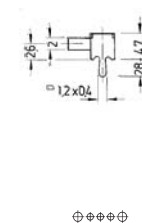
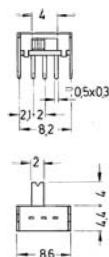

MFP 213 N – RA    on    on  
non-shorting

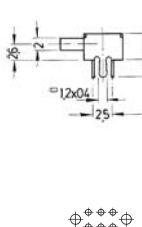
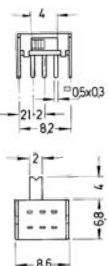

MFP 213 P – RA    on on on  
shorting

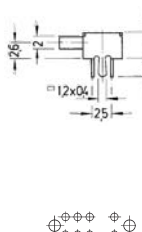
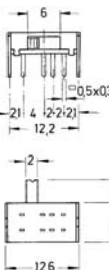



# Miniature Slide Switches

## Specifications:

Contact rating:	30 V DC, 350 mA
Contact resistance:	< 20 mΩ
Insulation resistance:	> 100 MΩ at 500 V DC
Dielectric strength:	500 V, 50 Hz for the duration of 1 minute
Mechanical life:	minimum 10 000 operations
Contacts:	copper alloy, silver-plated over nickel barrier
Contact timing:	non-shorting
Slide colour:	black, further colours on request
Soldering conditions:	auto-soldering – max.: 5 sec, 260° C ± 5° C

## Models:            Switching functions

MFP 102 D            on    on

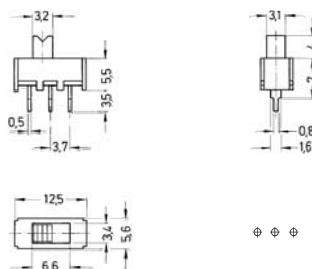

MFP 191 D            on    on

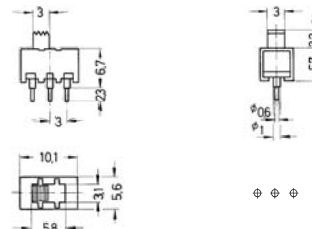

MFP 201 N            on    on

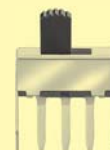
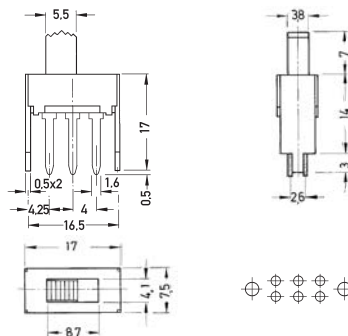

MFP 211 N            on    on

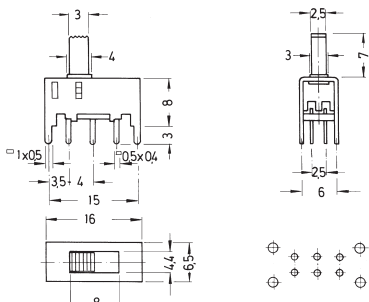



# Miniature Slide Switches

## Specifications:

Contact rating:	30 V DC, 350 mA
Contact resistance:	< 20 mΩ
Insulation resistance:	> 100 MΩ at 500 V DC
Dielectric strength:	500 V, 50 Hz for the duration of 1 minute
Mechanical life:	minimum 10 000 operations
Contacts:	copper alloy, silver-plated over nickel barrier
Slide colour:	black, further colours on request
Soldering conditions:	auto-soldering – max.: 5 sec, 260° C ± 5° C

## Models: Switching functions

MFP 221 N  
non-shorting

on on

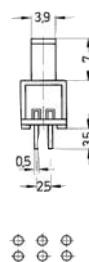
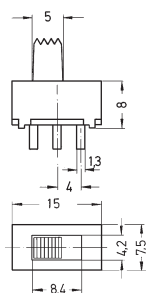

MFP 223 P  
shorting

on on on

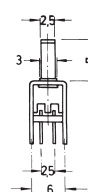
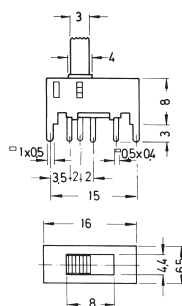

MFP 231 P  
shorting

on on on

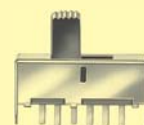
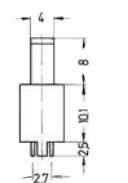
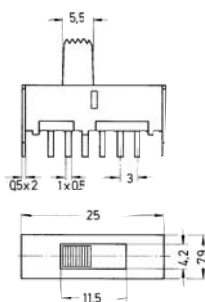

MFP 291 N  
non-shorting

on on

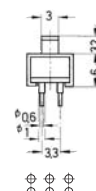
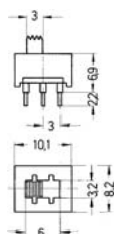



# Miniature Slide Switches

## Specifications:

Contact rating:	30 V DC, 350 mA
Contact resistance:	< 20 mΩ
Insulation resistance:	> 100 MΩ at 500 V DC
Dielectric strength:	500 V, 50 Hz for the duration of 1 minute
Mechanical life:	minimum 10 000 operations
Contacts:	copper alloy, silver-plated over nickel barrier
Slide colour:	black, further colours on request
Soldering conditions:	hand-soldering – max.: 5 sec, 270° C

## Models:

Switching functions

MFS 121 D  
non-shorting

on on 

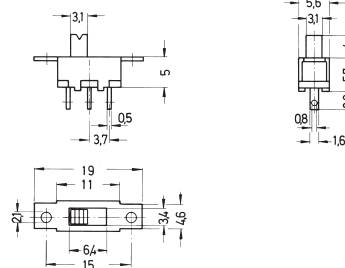

MFS 131 D  
non-shorting

on on 

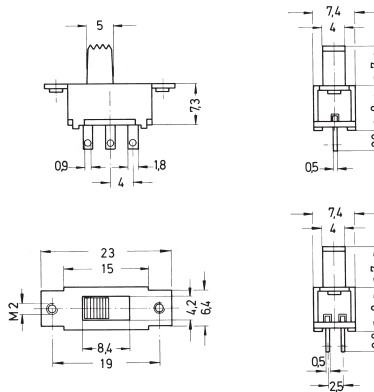

MFS 201 N  
non-shorting

on on 

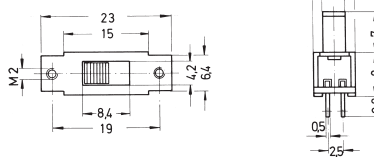

MFS 231 P  
shorting

on on on 

