



### FEATURES

- RoHS compliant
- Basic/supplementary isolation to UL60950<sup>2</sup>
- ANSI/AAMI ES60601-1
- Power density 0.81W/cm<sup>3</sup>
- Single and dual outputs
- UL 94V-0 package material
- Footprint 1.96cm<sup>2</sup>
- SIP package style
- 5.2kVDC isolation 'Hi Pot Test'
- 3.3V, 5V, 12V & 15V inputs
- 3.3V, 5V, 9V, 12V & 15V output
- Internal SMD construction
- Fully encapsulated with toroidal magnetics
- Pin compatible with the MEV, NMV, NMK, & NMJ series
- MTTF up to 3.9 million hours
- Characterised CMTI >200kV/μS
- Continuous barrier withstand voltage 2.4kVDC

### PRODUCT OVERVIEW

The MEJ2 series are single and dual output medically approved DC-DC converters in a 7 pin SIP package style offering a power upgrade path from the NMJ series SIP DC-DC converters. The MEJ2 series is UL60950 and ANSI/AAMI ES60601-1 recognised, which makes it ideal for applications where safety and miniaturisation are of paramount importance.

### SELECTION GUIDE

Order Code	Nominal Input Voltage	Output Voltage	Output Current	Input Current at Rated Load	Load Regulation (Typ)	Load Regulation (Max)	Ripple & Noise (Typ) <sup>3</sup>	Ripple & Noise (Max) <sup>3</sup>	Efficiency (Min)	Efficiency (Typ)	MTTF <sup>2</sup>
	V	V	mA		%		mVp-p		%		kHrs
MEJ2S0303SC	3.3	3.3	606	756	14.0	17	38	55	67	70	3910
MEJ2S0305SC	3.3	5	400	784	13.0	15	50	65	70	74	3757
MEJ2S0503SC	5	3.3	606	528	10.0	15	40	55	67	70	3830
MEJ2S0505SC	5	5	400	503	8.5	10	43	55	72	75	3654
MEJ2S0509SC	5	9	222	505	8.0	11	36	50	75	78	3472
MEJ2S0512SC	5	12	167	495	8.0	12	40	55	74	77	3663
MEJ2S0515SC	5	15	133	488	7.0	10	34	45	76	79	2629
MEJ2S1203SC	12	3.3	606	207	9.5	11	43	60	70	73	3259
MEJ2S1205SC	12	5	400	214	8.0	10	43	60	75	78	3200
MEJ2S1209SC	12	9	222	205	7.0	10	35	50	75	79	2453
MEJ2S1212SC	12	12	167	207	6.5	8	35	50	76	80	2779
MEJ2S1215SC	12	15	133	205	7.0	10	32	45	76	80	2707
MEJ2S1505SC	15	5	400	171	8.5	10	44	60	73	76	2638
MEJ2S1509SC	15	9	222	165	6.5	8	35	50	74	78	2203
MEJ2S1512SC	15	12	167	164	6.5	8	38	55	74	79	2330
MEJ2S1515SC	15	15	133	166	7.0	8	36	50	74	78	2100
MEJ2D0503SC	5	±3.3	±303	535	8.5	10	26	40	67	71	3969
MEJ2D0505SC	5	±5	±200	508	7.5	9	34	50	72	76	3654
MEJ2D0509SC	5	±9	±111	510	6.5	8	27	40	76	79	3472
MEJ2D0512SC	5	±12	±83	504	5.0	8	27	40	77	80	3663
MEJ2D0515SC	5	±15	±67	492	7.0	9	20	35	74	78	2629
MEJ2D1203SC	12	±3.3	±303	205	8.0	9	37	55	72	75	3270
MEJ2D1205SC	12	±5	±200	212	7.0	8	32	45	75	79	3268
MEJ2D1209SC	12	±9	±111	206	5.5	7	27	40	77	81	2453
MEJ2D1212SC	12	±12	±83	208	5.5	7	27	40	77	81	2779
MEJ2D1215SC	12	±15	±67	203	6.0	7	24	40	78	82	2707
MEJ2D1505SC	15	±5	±200	170	7.0	9	37	50	74	78	2638
MEJ2D1509SC	15	±9	±111	163	5.5	7	26	40	76	80	2203
MEJ2D1512SC	15	±12	±83	167	5.5	7	26	40	75	80	2330
MEJ2D1515SC	15	±15	±67	167	5.5	7	23	35	75	79	2100

### INPUT CHARACTERISTICS

Parameter	Conditions	Min.	Typ.	Max.	Units
Voltage range	Continuous operation, 3V input types	2.97	3.3	3.63	V
	Continuous operation, 5V input types	4.5	5	5.5	
	Continuous operation, 12V input types	10.8	12	13.2	
	Continuous operation, 15V input types	13.5	15	16.5	
Input reflected ripple	3.3V input types		100	140	mA
	5V input types		60	90	
	12V & 15V input types		22	40	



For full details go to [www.murata-ps.com/rohs](http://www.murata-ps.com/rohs)



1. Calculated using MIL-HDBK-217 FN2 calculation model with nominal input voltage at full load.  
 2. See safety approvals section for limitations of use.  
 3. See ripple & noise test method.  
 All specifications typical at T<sub>a</sub>=25°C, nominal input voltage and rated output current unless otherwise specified.

### ISOLATION CHARACTERISTICS

Parameter	Conditions	Min.	Typ.	Max.	Units
Isolation test voltage	Flash tested for 1 second	5200			VDC
Resistance	Viso= 500VDC		1		GΩ
Isolation capacitance			4		pF
Continuous barrier withstand voltage	Non-safety barrier application			2400	V
Safety standard	UL60950-1			200	Vrms
	ANSI/AAMI ES60601-1	1 MOOP		200	

### OUTPUT CHARACTERISTICS

Parameter	Conditions	Min.	Typ.	Max.	Units
Rated Power <sup>2</sup>	T <sub>A</sub> =-40°C to 85°C			2	W
Voltage Set Point Accuracy	See tolerance envelopes				
Line regulation	High V <sub>IN</sub> to low V <sub>IN</sub>		1.0	1.2	%/%

### TEMPERATURE CHARACTERISTICS

Parameter	Conditions	Min.	Typ.	Max.	Units
Specification	All output types (see safety approval section for limitations)	-40		85	°C
Storage		-55		125	
Case Temperature above ambient	MEJ2S0509SC, MEJ2S0512SC, MEJ2S0515SC, MEJ2S1209SC, MEJ2x1212SC, MEJ2S1215SC, MEJ2S1509SC, MEJ2S1512SC, MEJ2S1515SC		27		
	MEJ2S0503SC, MEJ2S0505SC, MEJ2S1203SC, MEJ2S1205SC, MEJ2x1505SC, MEJ2S1515SC, MEJ2D0512SC, MEJ2D0515SC, MEJ2D1209SC, MEJ2D1215SC		30		
	MEJ2S0305SC, MEJ2S0303SC, MEJ2S1203SC, MEJ2D0505SC, MEJ2D0509SC, MEJ2D1205SC, MEJ2D1509SC, MEJ2D1512SC		33		
	MEJ2D01203SC, MEJ2D0503SC		37		
Cooling	Free air convection				

### GENERAL CHARACTERISTICS

Parameter	Conditions	Min.	Typ.	Max.	Units
Switching frequency	All types		45		kHz

### ABSOLUTE MAXIMUM RATINGS

Short-circuit protection	10 minutes
Lead temperature 1mm from case for 10 seconds	260°C
Wave Solder	Wave Solder profile not to exceed the profile recommended in IEC 61760-1 Section 6.1.3. Please refer to <a href="#">application notes</a> for further information.
Input voltage V <sub>IN</sub> , MEJ2x03xxSC	5V
Input voltage V <sub>IN</sub> , MEJ2x05xxSC	7V
Input voltage V <sub>IN</sub> , MEJ2x12xxSC	15V
Input voltage V <sub>IN</sub> , MEJ2x15xxSC	18V

### TECHNICAL NOTES

#### ISOLATION VOLTAGE

'Hi Pot Test', 'Flash Tested', 'Withstand Voltage', 'Proof Voltage', 'Dielectric Withstand Voltage' & 'Isolation Test Voltage' are all terms that relate to the same thing, a test voltage, applied for a specified time, across a component designed to provide electrical isolation, to verify the integrity of that isolation.

Murata Power Solutions MEJ2 series of DC-DC converters are all 100% production tested at their stated isolation voltage. This is 5.2kVDC for 1 second.

The MEJ2 series is recognised by Underwriters Laboratory, please see safety approval section for more information. When the insulation in the MEJ2 series is not used as a safety barrier, i.e. provides functional isolation only, continuous or switched voltages across the barrier up to 2.4kV are sustainable. This is established by measuring the partial discharge inception voltage in accordance with IEC 60270. Please contact Murata for further information.

#### REPEATED HIGH-VOLTAGE ISOLATION TESTING

It is well known that repeated high-voltage isolation testing of a barrier component can actually degrade isolation capability, to a lesser or greater degree depending on materials, construction and environment. We therefore strongly advise against repeated high voltage isolation testing, but if it is absolutely required, that the voltage be reduced by 20% from specified test voltage.

### SAFETY APPROVAL

#### ANSI/AAMI ES60601-1

The MEJ2 series have recognised by Underwriters Laboratory (UL) to ANSI/AAMI ES60601-1 and provides 1 MOOP (Means Of Operator Protection) based upon a working voltage of 200 Vrms max and 280 Vpk max., between Primary and Secondary and between Primary and its Enclosure, in a maximum ambient temperature of 85°C and/or case temperature limit of 130°C (case temperature measured on the face opposite the pins).

File Number E202895 applies.

#### UL60950

The MEJ2 series have been recognised by Underwriters Laboratory (UL) to UL60950 for basic/supplementary insulation to a working voltage of 200Vrms in a maximum ambient temperature of 85°C and/or case temperature limit of 130°C (case temperature measured on the face opposite the pins).

File number E151252 applies.

Creepage and clearance 2mm

Working altitude 4000m

#### FUSING

The MEJ2 Series of converters are not internally fused so to meet the requirements of UL an anti-surge input line fuse should always be used with ratings as defined below.

MEJ2x03xxxC: 2A

MEJ2x05xxxC: 2A

MEJ2x12xxxC: 750mA

MEJ2x15xxxC: 750mA

All fuses should be UL recognised and rated to at least the maximum allowable DC input voltage.

### RoHS COMPLIANCE INFORMATION



This series is compatible with RoHS soldering systems with a peak wave solder temperature of 260°C for 10 seconds. Please refer to [application notes](#) for further information. The pin termination finish on this product series is Tin Plate, Hot Dipped over Matte Tin with Nickel Preplate. The series is backward compatible with Sn/Pb soldering systems. For further information, please visit [www.murata-ps.com/rohs](http://www.murata-ps.com/rohs)

**ENVIRONMENTAL VALIDATION TESTING**

The following tests have been conducted on this product series, please contact Murata if further information about the tests is required.

Test	Standard	Condition
Temperature cycling	MIL-STD 883 1010, Condition B	10 cycles between two chambers set to achieve -55°C and +125°C. The dwell time shall not be less than 10min.
Humidity bias	JEDEC STD 22-A101	85°C ± 2°C, 85% ± 5% R.H. for >1000 hours.
Storage life	JEDEC JESD22-A103, Condition A	125°C +10/-0°C for ≥1000 hours.
Vibration	MIL STD 883 Method 2007, Condition A	1.5mm pk-pk / 20g pk min, 20-2000Hz, 4 sweeps in each of 3 mutually perpendicular axes at 3 oct/min.
Shock	MIL STD 883 method 2002, Condition A	500g 1.0ms half sine, 5 shocks in each direction of 3 mutually perpendicular axes.
ESD	JESD22-A114	HBM Testing Standard at 3 stress levels; 2.0kV, 4.0kV and 8.0kV.
Bump	IEC Class 4M5 of ETS 300 019-2-4	Shock Spectrum Type II, 6ms duration, 250m/s <sup>2</sup> 500 bumps in 6 directions.
Solderability	IPC/ECA J-STD-002, Test A1	For lead free solderability the parts are conditioned in a steam ager for 8 hours ± 15 min. at a temperature of 93±3°C. Dipped in solder at 255°C ±5°C for 5 +0/-0.5 seconds. For leaded solderability the parts are conditioned in a steam ager for 8 hours ±15 min. at a temperature of 93±3°C. Dipped in solder at 245°C ±5°C for 5 +0/-0.5 seconds
Solder heat	JEDEC JESD22-B106	The test sample is subjected to a molten solder bath at 260 ±5°C for 10 seconds (96SC tin/silver/copper).
Solder heat (hand)	MIL-STD 202 Method 210, Condition A	The soldering iron is heated to 350°C ± 10°C and applied to the terminations for a duration of 4 to 5 seconds.
Solvent cleaning	Resistance to cleaning agents.	Solvent – Novec 71IPA & Topklean EL-20A. Pulsed ultrasonic immersion 45°C - 65°C
Solvent Resistance	MIL-STD 883 Method 2015	Separate samples subjected to solvent A, solvent B and solvent D
Lead Integrity (Adhesion)	MIL-STD 883 Method 2025	Leads are bent through 90° until a fracture occurs.
Lead Integrity (Fatigue)	MIL-STD 883 Method 2004, condition B <sub>2</sub>	The leads are bent to an angle of 15°. Each lead is subjected to 3 cycles.
Lead Integrity (Tension/Pull)	MIL-STD 883 Method 2004, Condition A <sub>1</sub>	Pull of 0.227kg applied for 30 seconds. The force is then increased until the pins snap.

**PART NUMBER STRUCTURE**

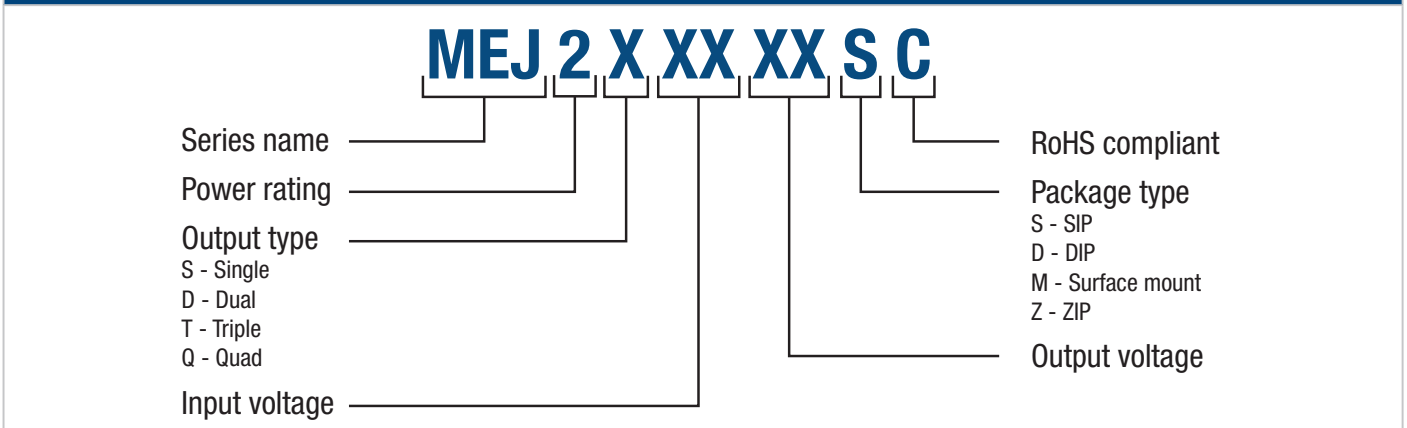

**APPLICATION NOTES**

**Minimum load**

The minimum load to meet datasheet specification is 10% of the full rated load across the specified input voltage range. Lower than 10% minimum loading will result in an increase in output voltage, which may rise to typically double the specified output voltage if the output load falls to less than 5%.

**Gate Drive Applications Advisory Note**

For general guidance for product usage in gate drive applications please refer to [“gate drive application notes”](#).

**Capacitive loading and start up**

Typical start up times for this series, with a typical input voltage rise time of 2.2µs and output capacitance of 10µF, are shown in the table below. The product series will start into a capacitance of 47µF with an increased start time, however, the maximum recommended output capacitance is 10µF.

	Start-up time µs		Start-up time µs		Start-up time µs
MEJ2S0303SC	0.89	MEJ2S1509SC	3.37	MEJ2D1505SC	1.79
MEJ2S0305SC	1.89	MEJ2S1512SC	4.47	MEJ2D1509SC	5.16
MEJ2S0503SC	1.08	MEJ2S1515SC	6.05	MEJ2D1512SC	7.04
MEJ2S0505SC	2.04	MEJ2D0503SC	1.57	MEJ2D1515SC	10.48
MEJ2S0509SC	6.5	MEJ2D0505SC	1.79		
MEJ2S0512SC	8.29	MEJ2D0509SC	9.32		
MEJ2S0515SC	11.4	MEJ2D0512SC	14.9		
MEJ2S1203SC	0.73	MEJ2D0515SC	20.84		
MEJ2S1205SC	1.61	MEJ2D1203SC	1.03		
MEJ2S1209SC	4.04	MEJ2D1205SC	2.51		
MEJ2S1212SC	5.51	MEJ2D1209SC	6.46		
MEJ2S1215SC	7.61	MEJ2D1212SC	9.94		
MEJ2S1505SC	1.33	MEJ2D1215SC	14.54		

Typical Start-Up Wave Form

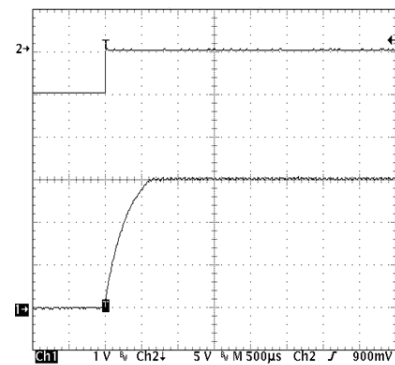

**Ripple & Noise Characterisation Method**

Ripple and noise measurements are performed with the following test configuration.

C1	1µF X7R multilayer ceramic capacitor, voltage rating to be a minimum of 3 times the output voltage of the DC-DC converter
C2	10µF tantalum capacitor, voltage rating to be a minimum of 1.5 times the output voltage of the DC-DC converter with an ESR of less than 100mΩ at 100 kHz
C3	100nF multilayer ceramic capacitor, general purpose
R1	450Ω resistor, carbon film, ±1% tolerance
R2	50Ω BNC termination
T1	3T of the coax cable through a ferrite toroid
RLOAD	Resistive load to the maximum power rating of the DC-DC converter. Connections should be made via twisted wires

Measured values are multiplied by 10 to obtain the specified values.

**Differential Mode Noise Test Schematic**

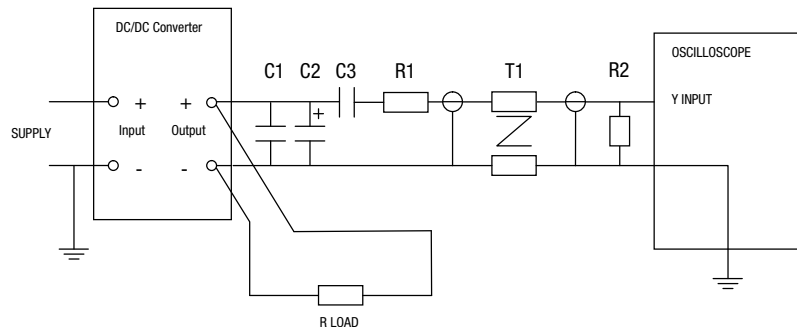

### TEMPERATURE DERATING GRAPH

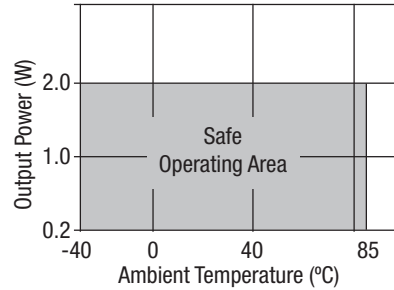

UL60950 recognition to a maximum ambient temperature of 85°C and/or case temperature limit of 155°C, measured on the face opposite the pins.

### TOLERANCE ENVELOPES

The voltage tolerance envelope shows typical load regulation characteristics for this product series. The tolerance envelope is the maximum output voltage variation due to changes in output loading.

**MEJ2X0303SC**

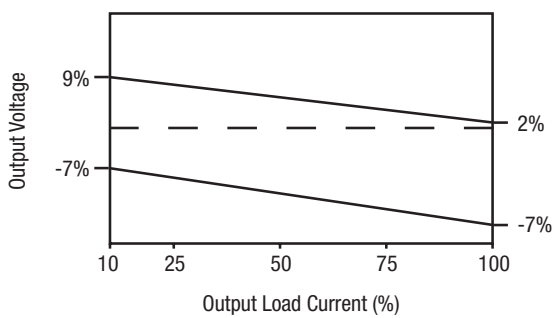

**MEJ2D0515SC**

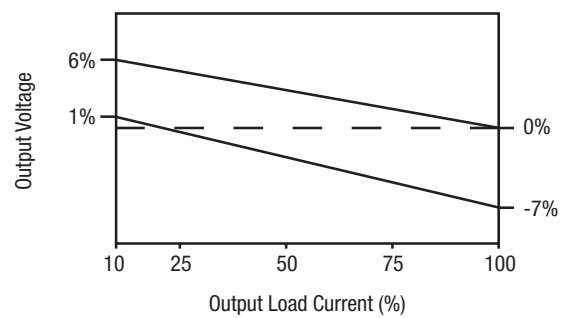

**All Other Variants**

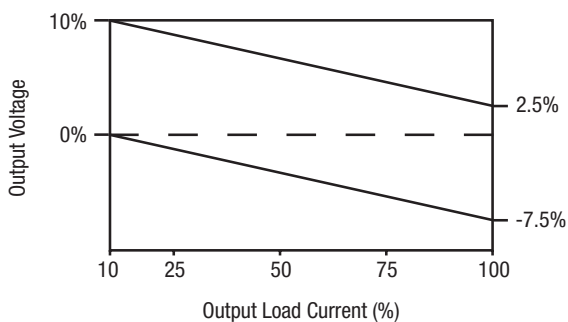

**EFFICIENCY VS LOAD**

**MEJ2S03XXSC**

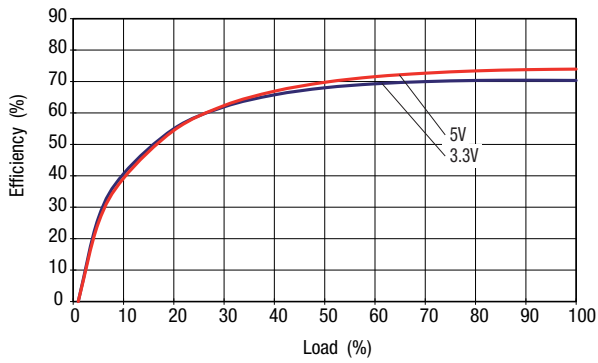

**MEJ2S05XXSC**

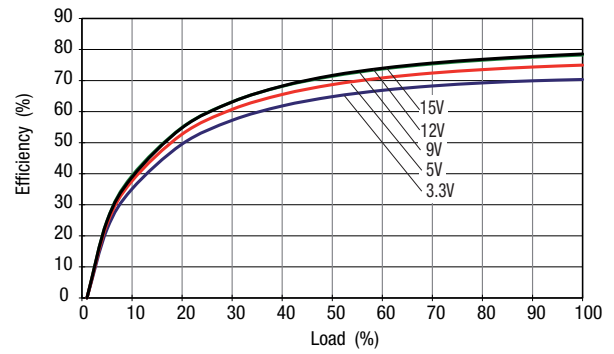

**MEJ2S12XXSC**

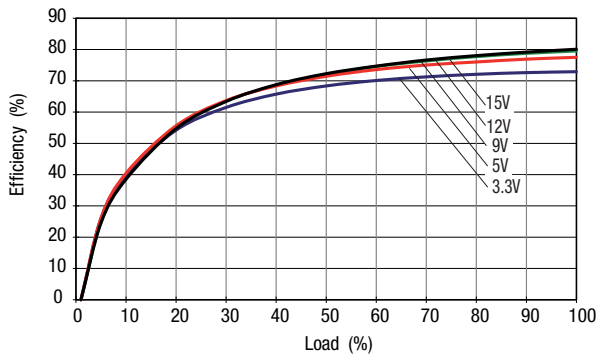

**MEJ2S15XXSC**

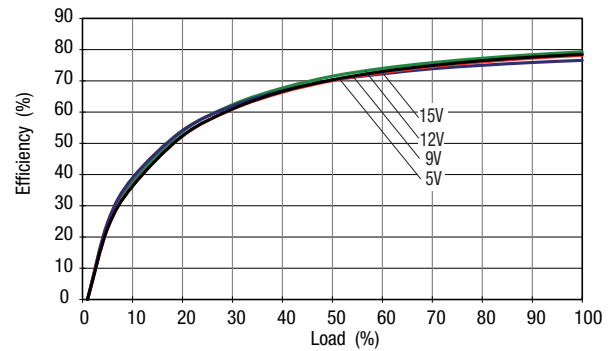

**EFFICIENCY VS LOAD**

**MEJ2D05XXSC**

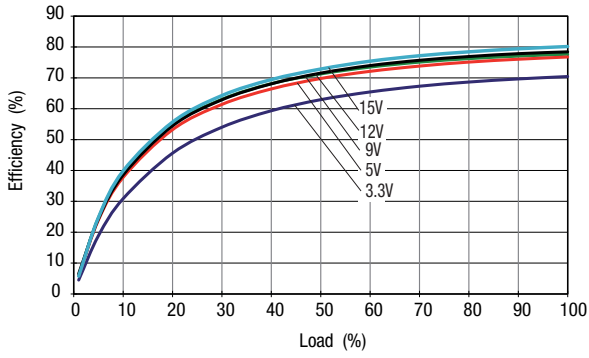

**MEJ2D12XXSC**

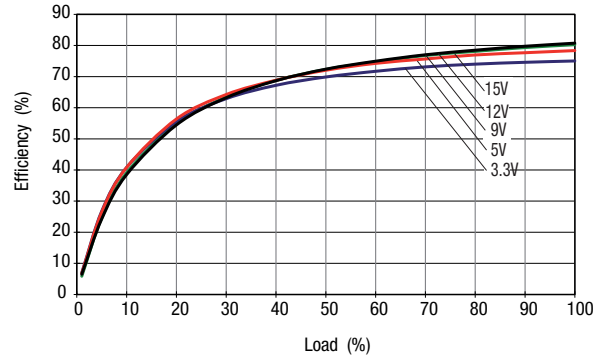

**MEJ2D15XXSC**

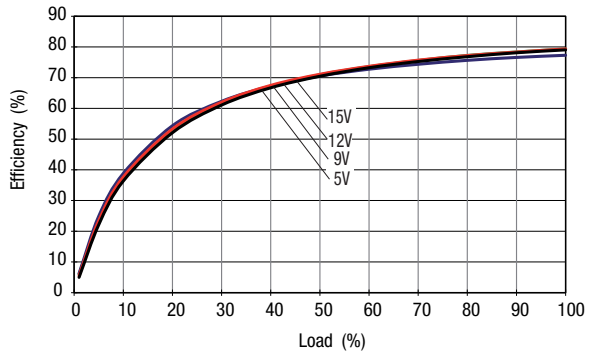



**PACKAGE SPECIFICATIONS**

**MECHANICAL DIMENSIONS**

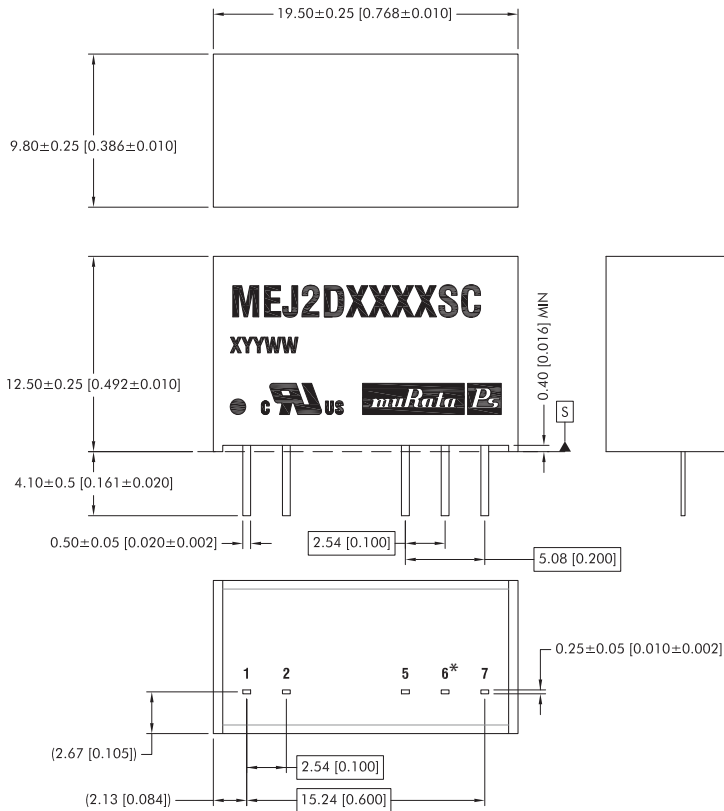

All dimensions in mm (inches).  
 Controlling dimension is mm.  
 All pins on a 2.54 (0.100) pitch and within ±0.1 (0.004) of true position from pin 1 at seating plane 'S'  
 \* Pin not fitted on single output variants.

Weight: 4.3g

**PIN CONNECTIONS**

**Single Output**

Pin	Function
1	+Vin
2	-Vin
5	-Vout
7	+Vout

**Dual Output**

Pin	Function
1	+VIN
2	-VIN
5	-VOUT
6*	OV
7	+VOUT

**TUBE OUTLINE DIMENSIONS**

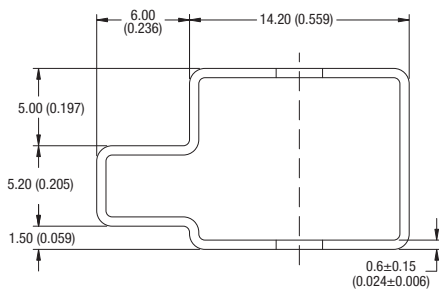

Unless otherwise stated all dimensions in mm ±0.5mm (inches ±0.02).  
 Tube length : 20.669±0.079 (525mm±2mm).

Tube Quantity : 25

**RECOMMENDED FOOTPRINT DETAILS**

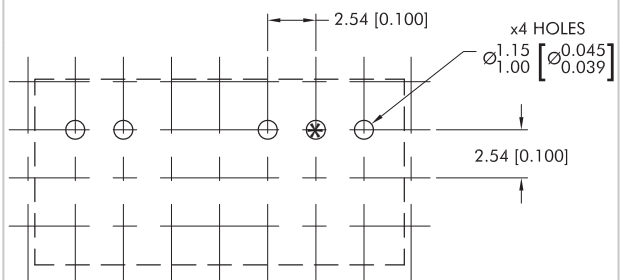

\* Hole not required for single output variants.  
 All dimensions in mm ±0.25mm (inches ±0.01).



This product is subject to the following **operating requirements** and the **Life and Safety Critical Application Sales Policy**:  
 Refer to: <http://www.murata-ps.com/requirements/>

Murata Power Solutions (Milton Keynes) Ltd. makes no representation that the use of its products in the circuits described herein, or the use of other technical information contained herein, will not infringe upon existing or future patent rights. The descriptions contained herein do not imply the granting of licenses to make, use, or sell equipment constructed in accordance therewith. Specifications are subject to change without notice.  
 © 2020 Murata Power Solutions (Milton Keynes) Ltd.