

MD9238 series

HIGH PERFORMANCE

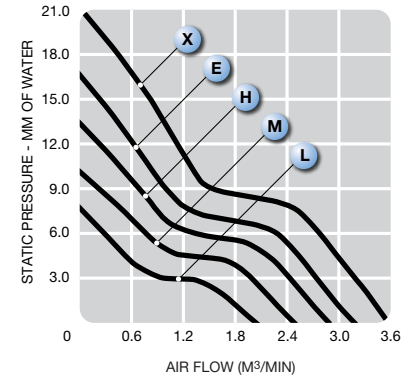
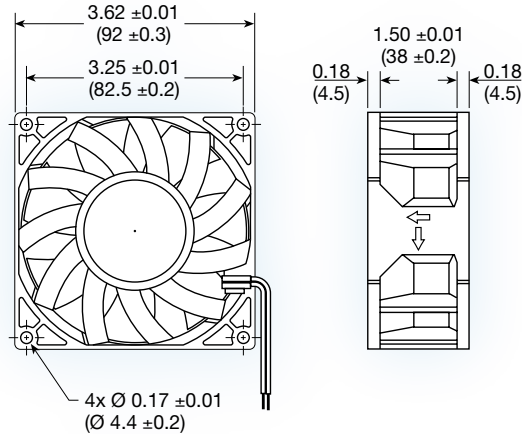

(92 x 92 x 38 mm)
3.62 x 3.62 x 1.5 inches

Construction:	UL94V-0 PBT impeller & frame
Bearing option:	ball bearing
Connection:	AWG 24, UL1007 lead wires
Frame:	flanged
Protection:	thermal
Options:	tachometer output or locked rotor alarm signal; PWM speed control

Model No.	Rated Voltage V	Current mA			Speed RPM	Air Volume		Max. Static Pressure (H ₂ O)		Sound Noise dBa	Weight g
		12	24	48		M ³ /Min.	CFM	MM	INCH		
MD9238L	12/24/48	360	190	100	3,200	2.01	71.06	7.86	0.31	44.5	180
MD9238M	12/24/48	580	300	200	3,800	2.46	86.85	10.24	0.40	50.0	180
MD9238H	12/24/48	880	450	220	4,400	2.85	100.69	15.30	0.60	53.5	180
MD9238E	12/24	1000	500	-	4,800	3.13	110.56	16.93	0.67	55.0	180
MD9238X	24	-	700	-	5,400	3.50	123.57	21.39	0.84	58.4	180