

MD-500-U

Electrical Specifications (@25C)

1. Maximum Power: 500VA
2. Input Voltage (power cord) : 120VAC±10%, 50/60Hz
3. Output Voltage (receptacle) : 120.0VAC @ 4.35A Max¹
4. Voltage Regulation: 5% TYP from full load to no load
5. Hipot:
 - Input to output: 3000VAC
 - Input and output to enclosure (Ground): 1500VAC
6. Efficiency: 94% TYP. @ full load
7. Operating ambient temperature: Not to exceed 60°C
8. Leakage current: less than 50uA; typical 10uA
9. Fusing: Replace only with 6.0A, 250VAC, slow blo, UL listed fuses.

Construction:

These medical grade isolation boxes are built using a toroidal transformer construction that inherently helps reduce stray fields, increases efficiency and minimizes size compared to traditional EI transformers. Built with Class F (155°) insulation system. The enclosure is made of steel and powder coated white.

Safety:

Medical isolation transformer box is certified to UL 60601-1, 2nd edition medical standard and CSA-C22.2.No. 601.1M90, 2005

UL: (E352717), UL60601-1, 2nd edition and CAN/CSA-C22.2 No. 601.1M90, 2005

Note: Not for use in life critical application



Mounting:

Rubber feet for horizontal mounting.

Connections:

Input: 11ft medical grade power cord with Nema 5-15P plug.

Output: Duplex receptacle. Nema 5-15R.

Schematic:

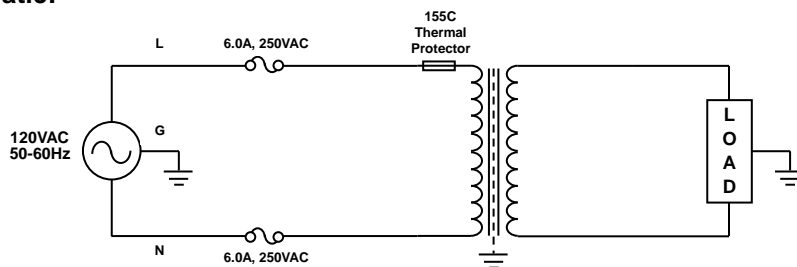

Please refer to instruction manual for safety precautions.

RoHS Compliance: As of manufacturing date February 2016, all standard products meet the requirements of 2015/863/EU, known as the RoHS 3 initiative.

* Upon printing, this document is considered "uncontrolled". Please contact Triad Magnetics' website for the most current version.

¹ Combined loads connected to receptacle(s) must not exceed maximum current rating.

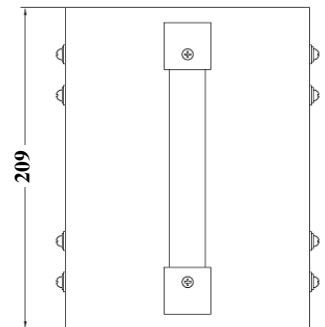
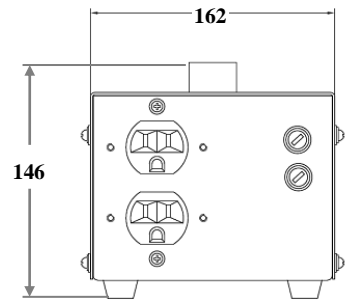

Dimensions: mm

Weight: 4.5Kg

Warranty: 5 years