

Feed-through header - MCV 1,5/ 7-GF-3,5 - 1843279

Please be informed that the data shown in this PDF Document is generated from our Online Catalog. Please find the complete data in the user's documentation. Our General Terms of Use for Downloads are valid (<http://phoenixcontact.com/download>)

PCB headers, nominal current: 8 A, rated voltage (III/2): 160 V, Nominal cross section: 1.5 mm², number of positions: 7, pitch: 3.5 mm, color: green, contact surface: Tin, mounting: Wave soldering, Pin layout: Linear pinning, solder pin [P]: 3.4 mm



The figure shows a 10-position version of the product

Your advantages

- ✓ Well-known mounting principle allows worldwide use
- ✓ Screwable flange for superior mechanical stability
- ✓ Vertical connection enables multi-row arrangement on the PCB
- ✓ Maximum flexibility when it comes to device design – one header for connectors with different connection technologies

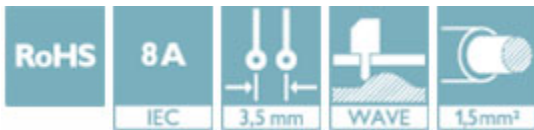

Key Commercial Data

| | |
|--------------------------------------|---------------|
| Packing unit | 1 pc |
| Minimum order quantity | 100 pc |
| GTIN | |
| GTIN | 4017918112462 |
| Weight per Piece (excluding packing) | 2.990 g |
| Custom tariff number | 85366930 |
| Country of origin | Germany |

Technical data

Item properties

| | |
|---------------------------|---------------------|
| Brief article description | Feed-through header |
| Plug-in system | MINI COMBICON |
| Type of contact | Male connector |
| Range of articles | MCV 1,5/...-GF |

Feed-through header - MCV 1,5/ 7-GF-3,5 - 1843279

Technical data

Item properties

| | |
|-----------------------|-----------------|
| Pitch | 3.5 mm |
| Number of positions | 7 |
| Mounting type | Wave soldering |
| Pin layout | Linear pinning |
| Locking | Threaded flange |
| Number of levels | 1 |
| Number of connections | 7 |
| Number of potentials | 7 |

Electrical parameters

| | |
|--------------|-------|
| Nom. voltage | 160 V |
|--------------|-------|

Material data - contact

| | |
|---|---|
| Note | WEEE/RoHS-compliant, free of whiskers according to IEC 60068-2-82/ JEDEC JESD 201 |
| Contact material | Cu alloy |
| Surface characteristics | Tin-plated |
| Metal surface contact area (top layer) | Tin (3 - 5 µm Sn) |
| Metal surface contact area (middle layer) | Nickel (1 - 3 µm Ni), |
| Metal surface soldering area (top layer) | Tin (3 - 5 µm Sn) |
| Metal surface soldering area (middle layer) | Nickel (1 - 3 µm Ni) |

Material data - housing

| | |
|--|------|
| Insulating material | PBT |
| Insulating material group | IIIa |
| CTI according to IEC 60112 | 225 |
| Flammability rating according to UL 94 | V0 |

Dimensions for the product

| | |
|-----------------------------|--------------|
| Length [l] | 7.25 mm |
| Width [w] | 34.8 mm |
| Height [h] | 12.6 mm |
| Pitch | 3.5 mm |
| Height (without solder pin) | 9.2 mm |
| Solder pin [P] | 3.4 mm |
| Pin dimensions | 0.8 x 0.8 mm |
| Dimension a | 21 mm |

Dimensions for PCB design

| | |
|---------------|--------|
| Hole diameter | 1.2 mm |
|---------------|--------|

Feed-through header - MCV 1,5/ 7-GF-3,5 - 1843279

Technical data

Packaging information

| | |
|----------------------------|---------------------|
| Type of packaging | packed in cardboard |
| Pieces per package | 100 |
| Denomination packing units | Pcs. |

Ambient conditions

| | |
|---|---|
| Ambient temperature (storage/transport) | -40 °C ... 70 °C |
| Ambient temperature (assembly) | -5 °C ... 100 °C |
| Ambient temperature (operation) | -40 °C ... 100 °C (dependent on the derating curve) |

Air clearances and creepage distances

| | |
|---|---------------------|
| Clearances and creepage distances | IEC 60664-1:2007-04 |
| Specification | IEC 60664-1:2007-04 |
| Rated insulation voltage (III/3) | 160 V |
| Rated insulation voltage (III/2) | 160 V |
| Rated insulation voltage (II/2) | 250 V |
| Rated surge voltage (III/3) | 2.5 kV |
| Rated surge voltage (III/2) | 2.5 kV |
| Rated surge voltage (II/2) | 2.5 kV |
| Minimum clearance - inhomogeneous field (III/3) | 1.5 mm |
| Minimum clearance - inhomogeneous field (III/2) | 1.5 mm |
| Minimum clearance - inhomogeneous field (II/2) | 1.5 mm |
| Minimum creepage distance value (III/3) | 2.5 mm |
| Minimum creepage distance value (III/2) | 1.6 mm |
| Minimum creepage distance value (II/2) | 2.5 mm |

Mechanical tests (A)

| | |
|--|-------------|
| Insertion strength per pos. approx. | 6 N |
| Withdraw strength per pos. approx. | 5 N |
| Polarization when inserted requirement >20 N | Test passed |
| Contact holder in insert requirements >20 N | Test passed |

Durability tests (B)

| | |
|--|---------------------|
| Specification | IEC 60512-5:1992-08 |
| Contact resistance R ₁ | 1.8 mΩ |
| Insertion/withdrawal cycles | 25 |
| Contact resistance R ₂ | 2.2 mΩ |
| Impulse withstand voltage at sea level | 2.95 kV |
| Power-frequency withstand voltage | 1.39 kV |
| Insulation resistance, neighboring positions | 10 ¹² Ω |

Feed-through header - MCV 1,5/ 7-GF-3,5 - 1843279

Technical data

Climatic tests (D)

| | |
|--|---|
| Specification | ISO 6988:1985-02 |
| Cold stress | -40 °C/2 h |
| Thermal stress | 100 °C/168 h |
| Corrosive stress | 0.2 dm ³ SO ₂ on 300 dm ³ /40 °C/1 cycle |
| Impulse withstand voltage at sea level | 2.95 kV |
| Power-frequency withstand voltage | 1.39 kV |

Environmental and durability tests (E)

| | |
|---------------------------------------|-------------------------------------|
| Specification | IEC 61984:2008-10 |
| Result, degree of protection, IP code | Finger safety with IP20 test finger |

Vibration test

| | |
|------------------------|------------------------|
| Specification | IEC 60068-2-6:2007-12 |
| Result | Test passed |
| Frequency | 10 - 150 - 10 Hz |
| Sweep speed | 1 octave/min |
| Amplitude | 0.35 mm (10 - 60.1 Hz) |
| Acceleration | 5 g (60.1 - 150 Hz) |
| Test duration per axis | 2.5 h |

Standards and Regulations

| | |
|--|--------|
| Connection in acc. with standard | EN-VDE |
| | CSA |
| Flammability rating according to UL 94 | V0 |

Environmental Product Compliance

| | |
|------------|---|
| | Lead 7439-92-1 |
| China RoHS | Environmentally Friendly Use Period = 50 |
| | For details about hazardous substances go to tab "Downloads", Category "Manufacturer's declaration" |

Drawings

Feed-through header - MCV 1,5/ 7-GF-3,5 - 1843279

Drilling diagram

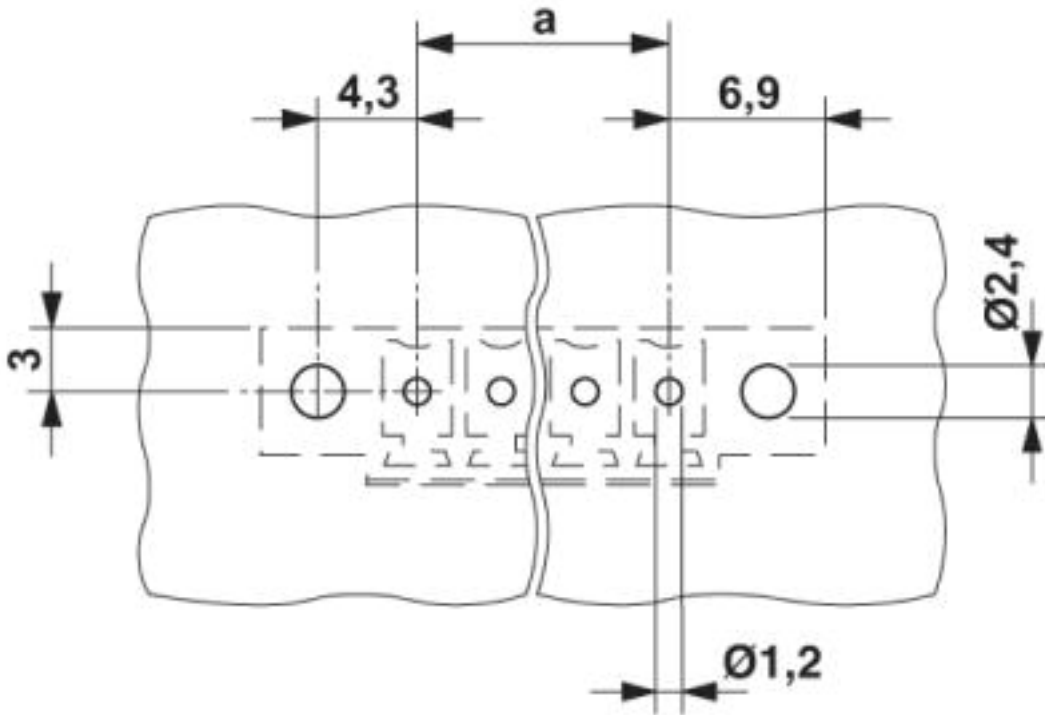

Diagram

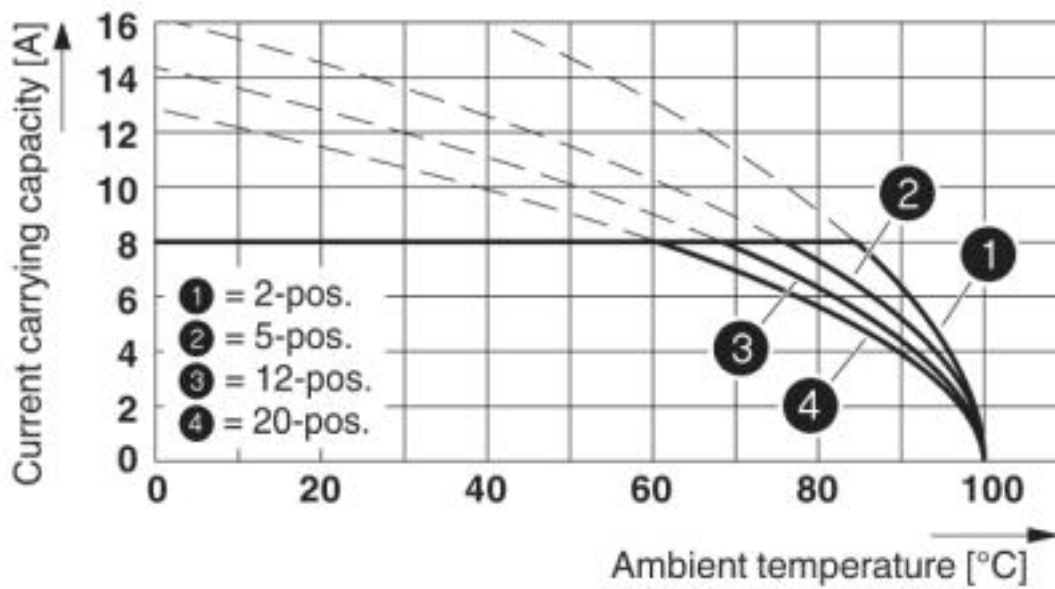

Feed-through header - MCV 1,5/ 7-GF-3,5 - 1843279

Diagram

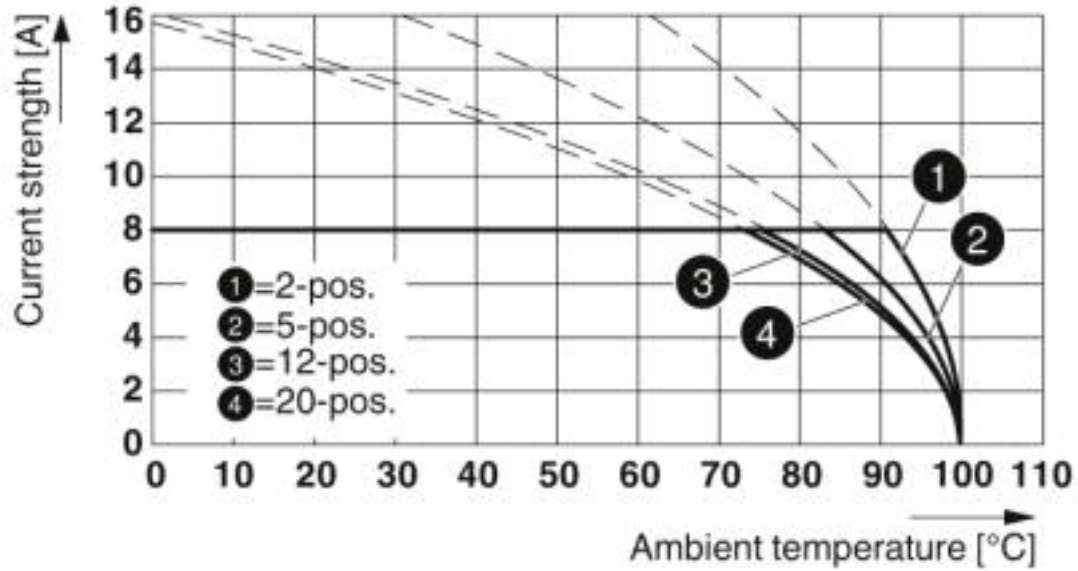

Type: MC 1,5/...-STF-3,5 with MCV 1,5/...-GF-3,5

Dimensional drawing

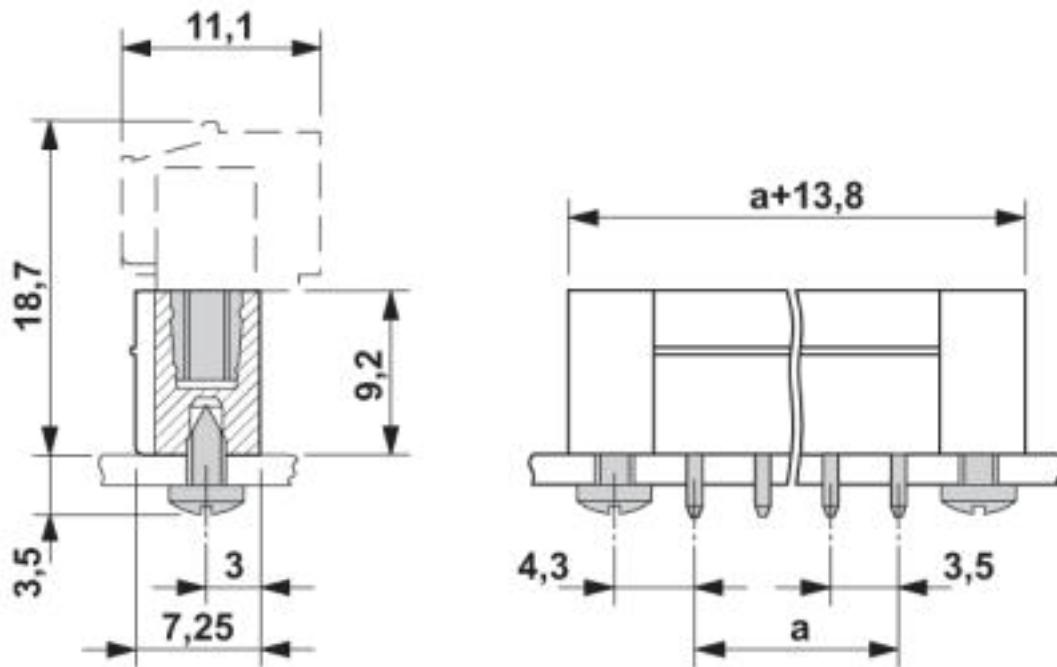

Feed-through header - MCV 1,5/ 7-GF-3,5 - 1843279

Classifications

eCl@ss

| | |
|------------|----------|
| eCl@ss 4.0 | 27260700 |
| eCl@ss 4.1 | 27260700 |
| eCl@ss 5.0 | 27260700 |
| eCl@ss 5.1 | 27260700 |
| eCl@ss 6.0 | 27260700 |
| eCl@ss 7.0 | 27440402 |
| eCl@ss 8.0 | 27440402 |
| eCl@ss 9.0 | 27440402 |

ETIM

| | |
|----------|----------|
| ETIM 3.0 | EC001121 |
| ETIM 4.0 | EC002637 |
| ETIM 5.0 | EC002637 |
| ETIM 6.0 | EC002637 |
| ETIM 7.0 | EC002637 |

UNSPSC

| | |
|---------------|----------|
| UNSPSC 6.01 | 30211810 |
| UNSPSC 7.0901 | 39121409 |
| UNSPSC 11 | 39121409 |
| UNSPSC 12.01 | 39121409 |
| UNSPSC 13.2 | 39121409 |
| UNSPSC 18.0 | 39121409 |
| UNSPSC 19.0 | 39121409 |
| UNSPSC 20.0 | 39121409 |
| UNSPSC 21.0 | 39121409 |

Approvals

Approvals

Approvals

CSA / IECCEB Scheme / VDE Gutachten mit Fertigungsüberwachung / EAC / cULus Recognized

Ex Approvals

Feed-through header - MCV 1,5/ 7-GF-3,5 - 1843279

Approvals

Approval details

| | | | |
|--------------------|---|---|-------|
| CSA |  | http://www.csagroup.org/services-industries/product-listing/ | 13631 |
| | B | D | |
| Nominal voltage UN | 300 V | 300 V | |
| Nominal current IN | 8 A | 8 A | |

| | | | |
|--------------------|---|---|----------------|
| IECEE CB Scheme |  | http://www.iecee.org/ | DE1-60987-B1B2 |
| Nominal voltage UN | 160 V | | |
| Nominal current IN | 8 A | | |

| | | | |
|--|---|---|----------|
| VDE Gutachten mit Fertigungsüberwachung |  | http://www2.vde.com/de/Institut/Online-Service/VDE-gepruefteProdukte/Seiten/Online-Suche.aspx | 40011723 |
| Nominal voltage UN | 160 V | | |
| Nominal current IN | 8 A | | |

| | | | |
|-----|---|--|---------|
| EAC |  | | B.01742 |
|-----|---|--|---------|

| | | | |
|--------------------|---|---|-----------------|
| cULus Recognized |  | http://database.ul.com/cgi-bin/XYV/template/LISEXT/1FRAME/index.htm | E60425-20110128 |
| | B | D | |
| Nominal voltage UN | 300 V | 300 V | |
| Nominal current IN | 8 A | 8 A | |

Accessories

Accessories

Coding element

Feed-through header - MCV 1,5/ 7-GF-3,5 - 1843279

Accessories

Coding profile - CP-MSTB - 1734634

Coding profile, is inserted into the slot on the plug or inverted header, red insulating material



Labeled terminal marker

Marker card - SK 3,5/2,8:FORTL.ZAHLEN - 0804073



Marker card, Card, white, labeled, Horizontal: consecutive numbers 1 ... 10, 11 ... 20, etc. up to 91 ... 99, mounting type: adhesive, for terminal block width: 3.5 mm, lettering field size: 3.5 x 2.8 mm

Additional products

Printed-circuit board connector - TFMC 1,5/ 7-STF-3,5 - 1772757

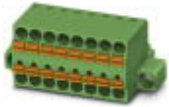

PCB connector, nominal current: 8 A, rated voltage (III/2): 160 V, Nominal cross section: 1.5 mm², number of positions: 7, pitch: 3.5 mm, connection method: Push-in spring connection, color: green, contact surface: Tin

Printed-circuit board connector - MC 1,5/ 7-STF-3,5 - 1847107



PCB connector, nominal current: 8 A, rated voltage (III/2): 160 V, Nominal cross section: 1.5 mm², number of positions: 7, pitch: 3.5 mm, connection method: Screw connection with tension sleeve, color: green, contact surface: Tin

Printed-circuit board connector - MCVW 1,5/ 7-STF-3,5 - 1863055



PCB connector, nominal current: 8 A, rated voltage (III/2): 160 V, Nominal cross section: 1.5 mm², number of positions: 7, pitch: 3.5 mm, connection method: Screw connection with tension sleeve, color: green, contact surface: Tin

Feed-through header - MCV 1,5/ 7-GF-3,5 - 1843279

Accessories

Printed-circuit board connector - MCVR 1,5/ 7-STF-3,5 - 1863356



PCB connector, nominal current: 8 A, rated voltage (III/2): 160 V, Nominal cross section: 1.5 mm², number of positions: 7, pitch: 3.5 mm, connection method: Screw connection with tension sleeve, color: green, contact surface: Tin

Printed-circuit board connector - FK-MCP 1,5/ 7-STF-3,5 - 1940143

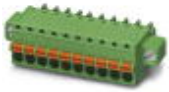

PCB connector, nominal current: 8 A, rated voltage (III/2): 160 V, Nominal cross section: 1.5 mm², number of positions: 7, pitch: 3.5 mm, connection method: Push-in spring connection, color: green, contact surface: Tin

Printed-circuit board connector - FMC 1,5/ 7-STF-3,5 - 1966143



PCB connector, nominal current: 8 A, rated voltage (III/2): 160 V, Nominal cross section: 1.5 mm², number of positions: 7, pitch: 3.5 mm, connection method: Push-in spring connection, color: green, contact surface: Tin
