

Feed-through header - MCV 1,5/10-GF-3,5 - 1843305

Please be informed that the data shown in this PDF Document is generated from our Online Catalog. Please find the complete data in the user's documentation. Our General Terms of Use for Downloads are valid (<http://phoenixcontact.com/download>)

PCB headers, nominal current: 8 A, rated voltage (III/2): 160 V, Nominal cross section: 1.5 mm², number of positions: 10, pitch: 3.5 mm, color: green, contact surface: Tin, mounting: Wave soldering, Pin layout: Linear pinning, solder pin [P]: 3.4 mm



The figure shows a 10-position version of the product

Your advantages

- ✓ Well-known mounting principle allows worldwide use
- ✓ Screwable flange for superior mechanical stability
- ✓ Vertical connection enables multi-row arrangement on the PCB
- ✓ Maximum flexibility when it comes to device design – one header for connectors with different connection technologies



Key Commercial Data

Packing unit	1 pc
Minimum order quantity	100 pc
GTIN	 4 017918 112493
GTIN	4017918112493
Weight per Piece (excluding packing)	3.640 g
Custom tariff number	85366930
Country of origin	Germany

Technical data

Item properties

Brief article description	Feed-through header
Plug-in system	MINI COMBICON
Type of contact	Male connector
Range of articles	MCV 1,5/..-GF

Feed-through header - MCV 1,5/10-GF-3,5 - 1843305

Technical data

Item properties

Pitch	3.5 mm
Number of positions	10
Mounting type	Wave soldering
Pin layout	Linear pinning
Locking	Threaded flange
Number of levels	1
Number of connections	10
Number of potentials	10

Electrical parameters

Nom. voltage	160 V
--------------	-------

Material data - contact

Note	WEEE/RoHS-compliant, free of whiskers according to IEC 60068-2-82/ JEDEC JESD 201
Contact material	Cu alloy
Surface characteristics	Tin-plated
Metal surface contact area (top layer)	Tin (3 - 5 µm Sn)
Metal surface contact area (middle layer)	Nickel (1 - 3 µm Ni),
Metal surface soldering area (top layer)	Tin (3 - 5 µm Sn)
Metal surface soldering area (middle layer)	Nickel (1 - 3 µm Ni)

Material data - housing

Insulating material	PBT
Insulating material group	IIIa
CTI according to IEC 60112	225
Flammability rating according to UL 94	V0

Dimensions for the product

Length [l]	7.25 mm
Width [w]	45.3 mm
Height [h]	12.6 mm
Pitch	3.5 mm
Height (without solder pin)	9.2 mm
Solder pin [P]	3.4 mm
Pin dimensions	0.8 x 0.8 mm
Dimension a	31.5 mm

Dimensions for PCB design

Hole diameter	1.2 mm
---------------	--------

Feed-through header - MCV 1,5/10-GF-3,5 - 1843305

Technical data

Packaging information

Type of packaging	packed in cardboard
Pieces per package	100
Denomination packing units	Pcs.

Ambient conditions

Ambient temperature (storage/transport)	-40 °C ... 70 °C
Ambient temperature (assembly)	-5 °C ... 100 °C
Ambient temperature (operation)	-40 °C ... 100 °C (dependent on the derating curve)

Air clearances and creepage distances

Clearances and creepage distances	IEC 60664-1:2007-04
Specification	IEC 60664-1:2007-04
Rated insulation voltage (III/3)	160 V
Rated insulation voltage (III/2)	160 V
Rated insulation voltage (II/2)	250 V
Rated surge voltage (III/3)	2.5 kV
Rated surge voltage (III/2)	2.5 kV
Rated surge voltage (II/2)	2.5 kV
Minimum clearance - inhomogeneous field (III/3)	1.5 mm
Minimum clearance - inhomogeneous field (III/2)	1.5 mm
Minimum clearance - inhomogeneous field (II/2)	1.5 mm
Minimum creepage distance value (III/3)	2.5 mm
Minimum creepage distance value (III/2)	1.6 mm
Minimum creepage distance value (II/2)	2.5 mm

Mechanical tests (A)

Insertion strength per pos. approx.	6 N
Withdraw strength per pos. approx.	5 N
Polarization when inserted requirement >20 N	Test passed
Contact holder in insert requirements >20 N	Test passed

Durability tests (B)

Specification	IEC 60512-5:1992-08
Contact resistance R ₁	1.8 mΩ
Insertion/withdrawal cycles	25
Contact resistance R ₂	2.2 mΩ
Impulse withstand voltage at sea level	2.95 kV
Power-frequency withstand voltage	1.39 kV
Insulation resistance, neighboring positions	10 ¹² Ω

Feed-through header - MCV 1,5/10-GF-3,5 - 1843305

Technical data

Climatic tests (D)

Specification	ISO 6988:1985-02
Cold stress	-40 °C/2 h
Thermal stress	100 °C/168 h
Corrosive stress	0.2 dm ³ SO ₂ on 300 dm ³ /40 °C/1 cycle
Impulse withstand voltage at sea level	2.95 kV
Power-frequency withstand voltage	1.39 kV

Environmental and durability tests (E)

Specification	IEC 61984:2008-10
Result, degree of protection, IP code	Finger safety with IP20 test finger

Vibration test

Specification	IEC 60068-2-6:2007-12
Result	Test passed
Frequency	10 - 150 - 10 Hz
Sweep speed	1 octave/min
Amplitude	0.35 mm (10 - 60.1 Hz)
Acceleration	5 g (60.1 - 150 Hz)
Test duration per axis	2.5 h

Standards and Regulations

Connection in acc. with standard	EN-VDE
	CSA
Flammability rating according to UL 94	V0

Environmental Product Compliance

	Lead 7439-92-1
China RoHS	Environmentally Friendly Use Period = 50
	For details about hazardous substances go to tab "Downloads", Category "Manufacturer's declaration"

Drawings

Feed-through header - MCV 1,5/10-GF-3,5 - 1843305

Drilling diagram

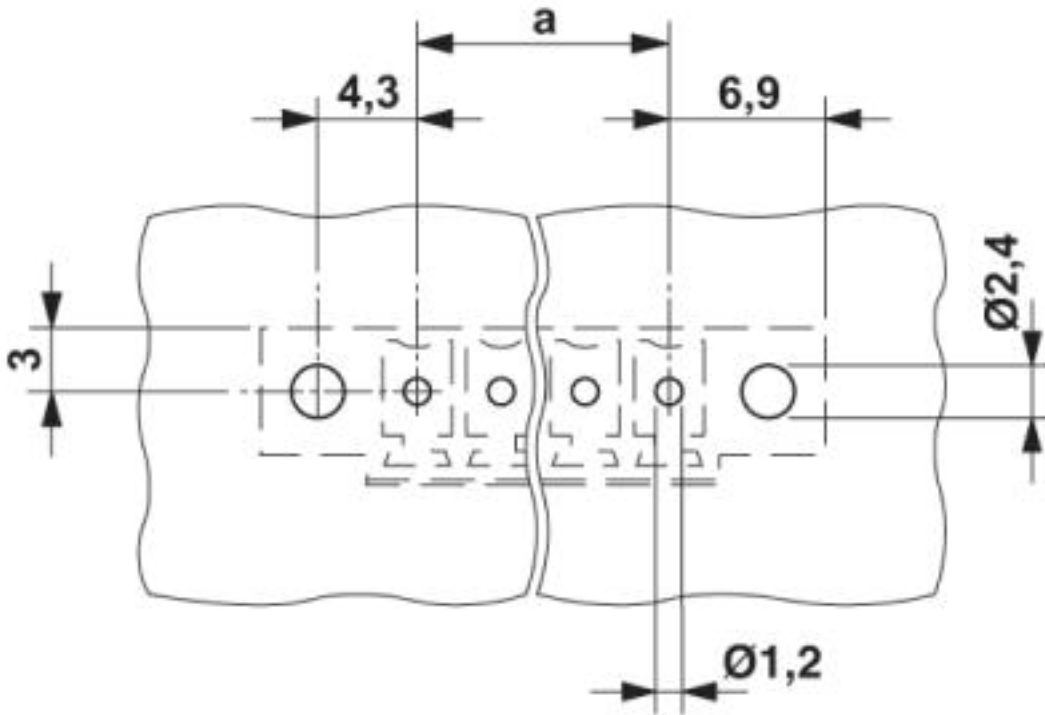

Diagram

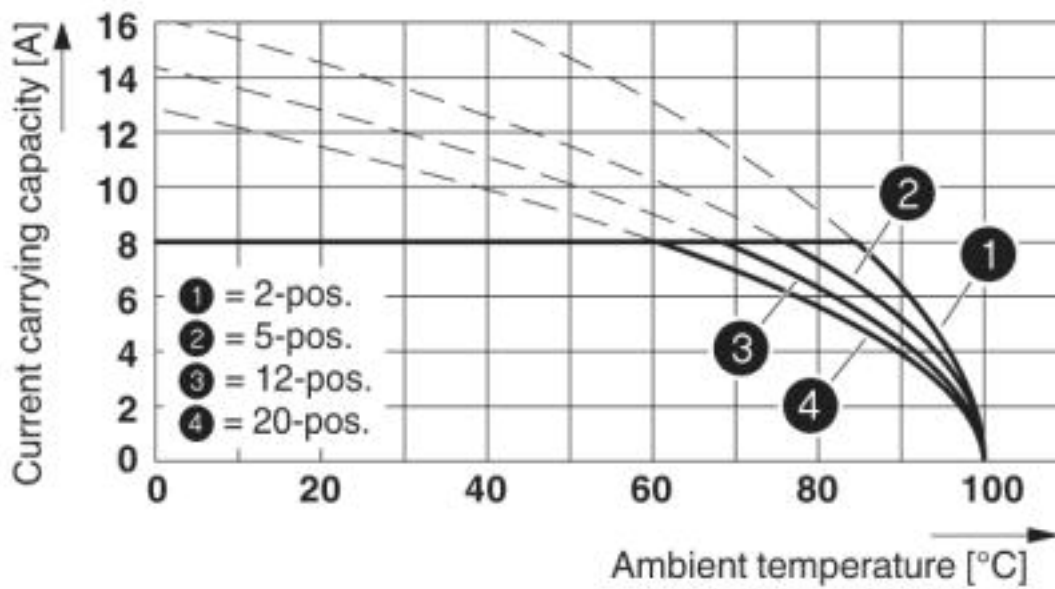

Feed-through header - MCV 1,5/10-GF-3,5 - 1843305

Diagram

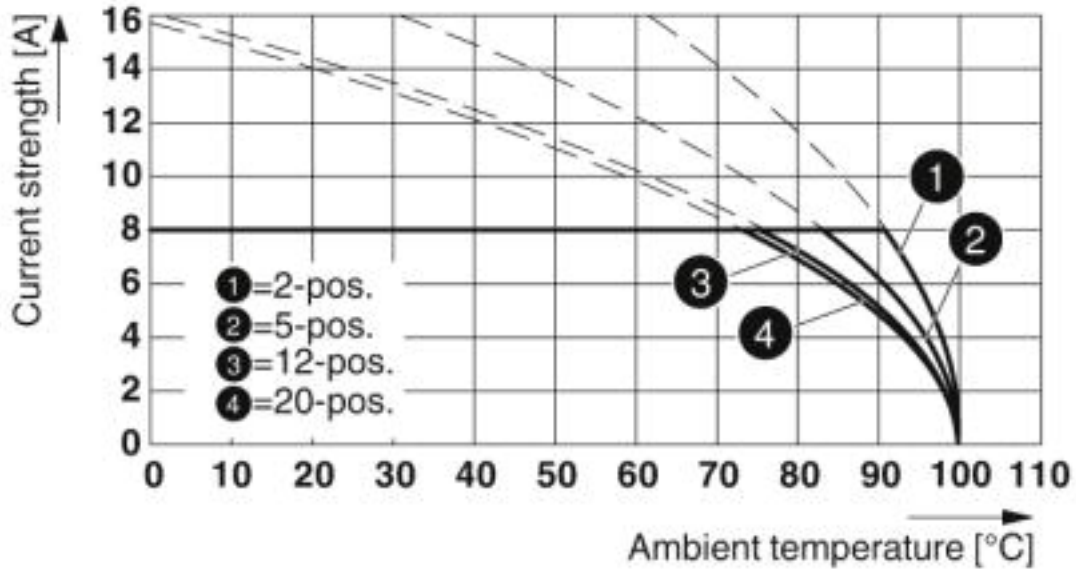

Type: MC 1,5/...-STF-3,5 with MCV 1,5/...-GF-3,5

Dimensional drawing

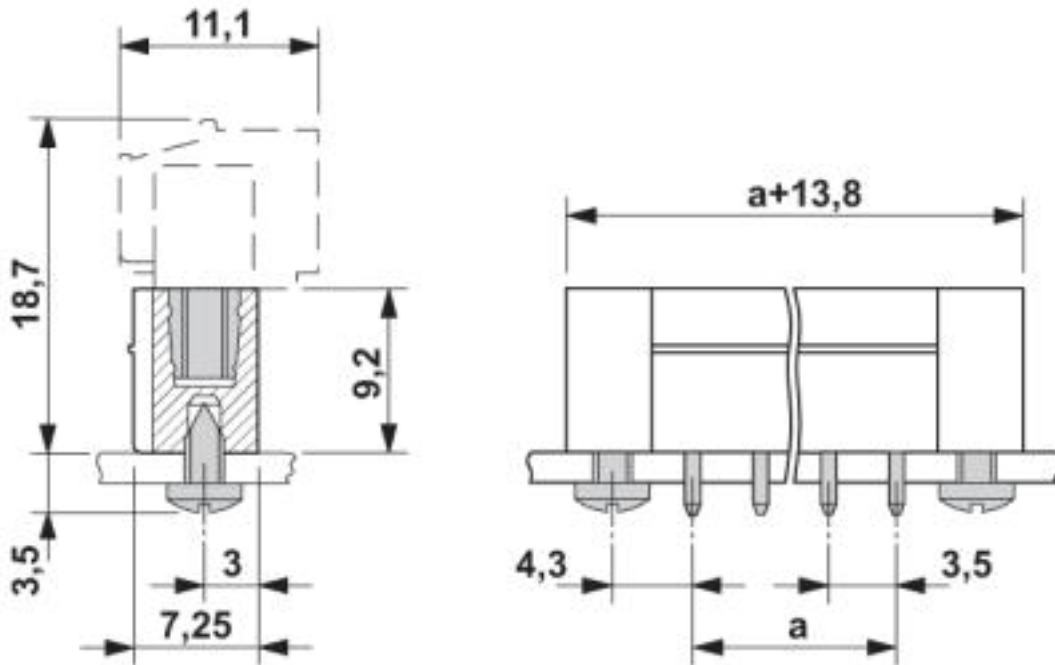

Feed-through header - MCV 1,5/10-GF-3,5 - 1843305

Classifications

eCl@ss

eCl@ss 4.0	27260700
eCl@ss 4.1	27260700
eCl@ss 5.0	27260700
eCl@ss 5.1	27260700
eCl@ss 6.0	27260700
eCl@ss 7.0	27440402
eCl@ss 8.0	27440402
eCl@ss 9.0	27440402

ETIM

ETIM 3.0	EC001121
ETIM 4.0	EC002637
ETIM 5.0	EC002637
ETIM 6.0	EC002637
ETIM 7.0	EC002637

UNSPSC

UNSPSC 6.01	30211810
UNSPSC 7.0901	39121409
UNSPSC 11	39121409
UNSPSC 12.01	39121409
UNSPSC 13.2	39121409
UNSPSC 18.0	39121409
UNSPSC 19.0	39121409
UNSPSC 20.0	39121409
UNSPSC 21.0	39121409

Approvals

Approvals

Approvals

CSA / IECCEB CB Scheme / VDE Gutachten mit Fertigungsüberwachung / EAC / cULus Recognized

Ex Approvals

Feed-through header - MCV 1,5/10-GF-3,5 - 1843305

Approvals

Approval details

CSA		http://www.csagroup.org/services-industries/product-listing/	13631
	B	D	
Nominal voltage UN	300 V	300 V	
Nominal current IN	8 A	8 A	

IECEE CB Scheme		http://www.iecee.org/	DE1-60987-B1B2
Nominal voltage UN	160 V		
Nominal current IN	8 A		

VDE Gutachten mit Fertigungsüberwachung		http://www2.vde.com/de/Institut/Online-Service/VDE-gepruefteProdukte/Seiten/Online-Suche.aspx	40011723
Nominal voltage UN	160 V		
Nominal current IN	8 A		

EAC			B.01742
-----	---	--	---------

cULus Recognized		http://database.ul.com/cgi-bin/XYV/template/LISEXT/1FRAME/index.htm	E60425-20110128
	B	D	
Nominal voltage UN	300 V	300 V	
Nominal current IN	8 A	8 A	

Accessories

Accessories

Coding element

Feed-through header - MCV 1,5/10-GF-3,5 - 1843305

Accessories

Coding profile - CP-MSTB - 1734634

Coding profile, is inserted into the slot on the plug or inverted header, red insulating material



Labeled terminal marker

Marker card - SK 3,5/2,8:FORTL.ZAHLEN - 0804073



Marker card, Card, white, labeled, Horizontal: consecutive numbers 1 ... 10, 11 ... 20, etc. up to 91 ... 99, mounting type: adhesive, for terminal block width: 3.5 mm, lettering field size: 3.5 x 2.8 mm

Additional products

Printed-circuit board connector - TFMC 1,5/10-STF-3,5 - 1772786

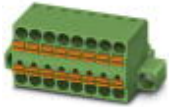

PCB connector, nominal current: 8 A, rated voltage (III/2): 160 V, Nominal cross section: 1.5 mm², number of positions: 10, pitch: 3.5 mm, connection method: Push-in spring connection, color: green, contact surface: Tin

Printed-circuit board connector - MC 1,5/10-STF-3,5 - 1847204



PCB connector, nominal current: 8 A, rated voltage (III/2): 160 V, Nominal cross section: 1.5 mm², number of positions: 10, pitch: 3.5 mm, connection method: Screw connection with tension sleeve, color: green, contact surface: Tin

Printed-circuit board connector - MCVW 1,5/10-STF-3,5 - 1863084



PCB connector, nominal current: 8 A, rated voltage (III/2): 160 V, Nominal cross section: 1.5 mm², number of positions: 10, pitch: 3.5 mm, connection method: Screw connection with tension sleeve, color: green, contact surface: Tin

Feed-through header - MCV 1,5/10-GF-3,5 - 1843305

Accessories

Printed-circuit board connector - MCVR 1,5/10-STF-3,5 - 1863385



PCB connector, nominal current: 8 A, rated voltage (III/2): 160 V, Nominal cross section: 1.5 mm², number of positions: 10, pitch: 3.5 mm, connection method: Screw connection with tension sleeve, color: green, contact surface: Tin

Printed-circuit board connector - FK-MCP 1,5/10-STF-3,5 - 1940172

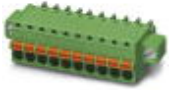

PCB connector, nominal current: 8 A, rated voltage (III/2): 160 V, Nominal cross section: 1.5 mm², number of positions: 10, pitch: 3.5 mm, connection method: Push-in spring connection, color: green, contact surface: Tin

Printed-circuit board connector - FMC 1,5/10-STF-3,5 - 1966172



PCB connector, nominal current: 8 A, rated voltage (III/2): 160 V, Nominal cross section: 1.5 mm², number of positions: 10, pitch: 3.5 mm, connection method: Push-in spring connection, color: green, contact surface: Tin
