

**RoHS
Compliant**



Kit Contains

1. Axial Fan - (MC36453)

Specifications

Dimension	: 172mm × 150mm × 51mm
Rated Voltage	: 115V AC 50 / 60 Hz
Operating Voltage	: 90V AC to 125V AC
Air flow	: 240 CFM
Noise level	: 48 dBA

Diagram

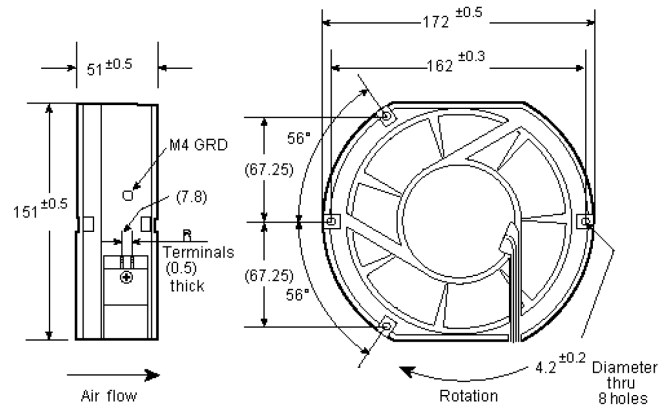

2. Fan Finger Guard - (MC32681)

Specifications

Material	: C1008 steel
Plating	: Bright nickel chrome
Ring diameter	: 1.8mm
Rib diameter	: 2.3mm

Diagram

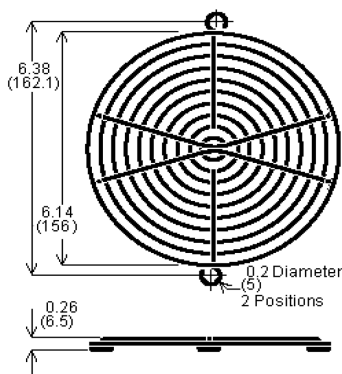

Dimensions : Inches (Millimetres)

Newark.com/multicomp-pro
Farnell.com/multicomp-pro
Element14.com/multicomp-pro

3. 45 Deg. Power Cord - (MC32797)

Specifications

Wire : SPT1 105°C, 300 volts, black
 Plug : NEMA 1-15P
 Length : 72" (1829mm)

Diagram

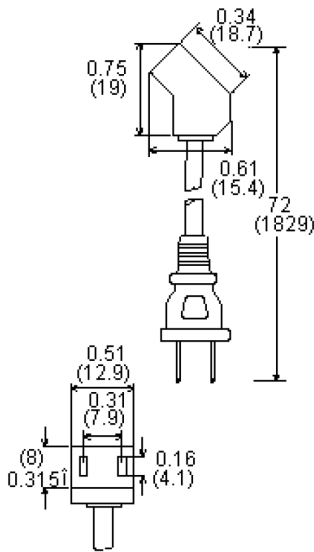

Part Number Table

Description	Part Number
Fan Kit (Fan, Fan Finger Guard and Power Cord)	MC36429

Dimensions : Inches (Millimetres)

Important Notice : This data sheet and its contents (the "Information") belong to the members of the AVNET group of companies (the "Group") or are licensed to it. No licence is granted for the use of it other than for information purposes in connection with the products to which it relates. No licence of any intellectual property rights is granted. The Information is subject to change without notice and replaces all data sheets previously supplied. The Information supplied is believed to be accurate but the Group assumes no responsibility for its accuracy or completeness, any error in or omission from it or for any use made of it. Users of this data sheet should check for themselves the Information and the suitability of the products for their purpose and not make any assumptions based on information included or omitted. Liability for loss or damage resulting from any reliance on the Information or use of it (including liability resulting from negligence or where the Group was aware of the possibility of such loss or damage arising) is excluded. This will not operate to limit or restrict the Group's liability for death or personal injury resulting from its negligence. Multicomp Pro is the registered trademark of Premier Farnell Limited 2019.

Newark.com/multicomp-pro
 Farnell.com/multicomp-pro
 Element14.com/multicomp-pro