

MA3075WALT1G, SZMA3075WALT1G

Zener Transient Voltage Suppressor

SOT-23 Dual Common Anode Zeners for ESD Protection

These dual monolithic silicon zener diodes are designed for applications requiring transient overvoltage protection capability. They are intended for use in voltage and ESD sensitive equipment such as computers, printers, business machines, communication systems, medical equipment and other applications. Their dual junction common anode design protects two separate lines using only one package. These devices are ideal for situations where board space is at a premium.

Features

- SOT-23 Package Allows Two Separate Unidirectional Configurations
- Low Leakage < 1 μ A @ 5.0 V
- Breakdown Voltage: 7.2–7.9 V @ 5 mA
- Low Capacitance (80 pF typical @ 0 V, 1 MHz)
- ESD Protection Meeting: 16 kV Human Body Model
30 kV Air and Contact Discharge
- SZ Prefix for Automotive and Other Applications Requiring Unique Site and Control Change Requirements; AEC-Q101 Qualified and PPAP Capable
- These Devices are Pb-Free, Halogen Free/BFR Free and are RoHS Compliant

Mechanical Characteristics:

- Void Free, Transfer-Molded, Thermosetting Plastic Case
- Corrosion Resistant Finish, Easily Solderable
- Package Designed for Optimal Automated Board Assembly
- Small Package Size for High Density Applications

MAXIMUM RATINGS

Rating	Symbol	Value	Unit
Peak Power Dissipation @ 100 μ s (Note 1)	P_{pk}	15	W
Steady State Power Dissipation Derate above 25°C (Note 2)	P_D	225 1.8	mW mW/°C
Thermal Resistance, Junction-to-Ambient	$R_{\theta JA}$	556	°C/W
Maximum Junction Temperature	$R_{\theta JA}$	417	°C/W
Operating Junction and Storage Temperature Range	T_J, T_{stg}	-55 to +150	°C
ESD Discharge MIL STD 883C – Method 3015-6 IEC61000-4-2, Air Discharge IEC61000-4-2, Contact Discharge	V_{PP}	16 30 30	kV

Stresses exceeding those listed in the Maximum Ratings table may damage the device. If any of these limits are exceeded, device functionality should not be assumed, damage may occur and reliability may be affected.

1. Non-repetitive 100 μ s pulse width
2. Mounted on FR-5 Board = 1.0 X 0.75 X 0.062 in.



ON Semiconductor®

www.onsemi.com

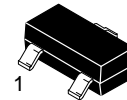
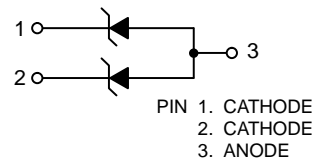

SOT-23
CASE 318
STYLE 12

MARKING DIAGRAM

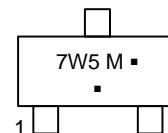

7W5 = Specific Device Code
M = Date Code*
▪ = Pb-Free Package

(Note: Microdot may be in either location)

*Date Code orientation and/or overbar may vary depending upon manufacturing location.

ORDERING INFORMATION

Device	Package	Shipping†
MA3075WALT1G	SOT-23 (Pb-Free)	3000 / Tape & Reel
SZMA3075WALT1G	SOT-23 (Pb-Free)	3000 / Tape & Reel

†For information on tape and reel specifications, including part orientation and tape sizes, please refer to our Tape and Reel Packaging Specifications Brochure, BRD8011/D.

MA3075WALT1G, SZMA3075WALT1G

ELECTRICAL CHARACTERISTICS

Parameter	Symbol	Conditions	Min	Typ	Max	Unit
Forward Voltage	V_F	$I_F = 10 \text{ mA}$		0.8	0.9	V
Zener Voltage ^{*2}	V_Z	$I_Z = 5 \text{ mA}$	7.2	7.5	7.9	V
Operating Resistance	R_{ZK}	$I_Z = 0.5 \text{ mA}$			120	Ω
	R_Z	$I_Z = 5 \text{ mA}$		6	15	Ω
Reverse Current	I_{R1}	$V_R = 5 \text{ V}$			1	μA
	I_{R2}	$V_R = 6.5 \text{ V}$			60	μA
Temperature Coefficient of Zener Voltage ^{*3}	S_Z	$I_Z = 5 \text{ mA}$	2.5	4.0	5.3	$\text{mV}/^\circ\text{C}$
Terminal Capacitance	C_t	$V_R = 0 \text{ V}$		80		pF

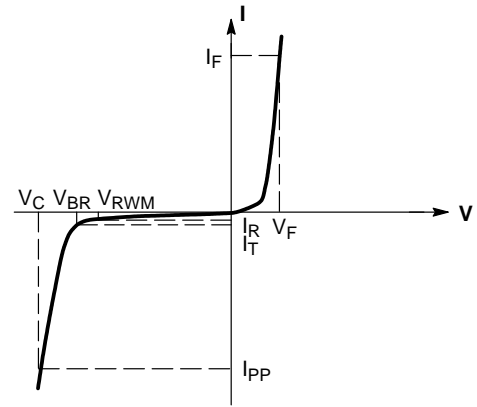

Uni-Directional TVS

Product parametric performance is indicated in the Electrical Characteristics for the listed test conditions, unless otherwise noted. Product performance may not be indicated by the Electrical Characteristics if operated under different conditions.

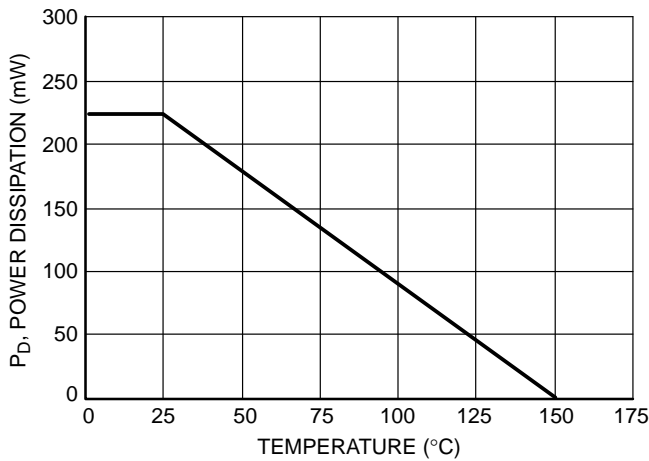

Figure 1. Steady State Power Derating Curve

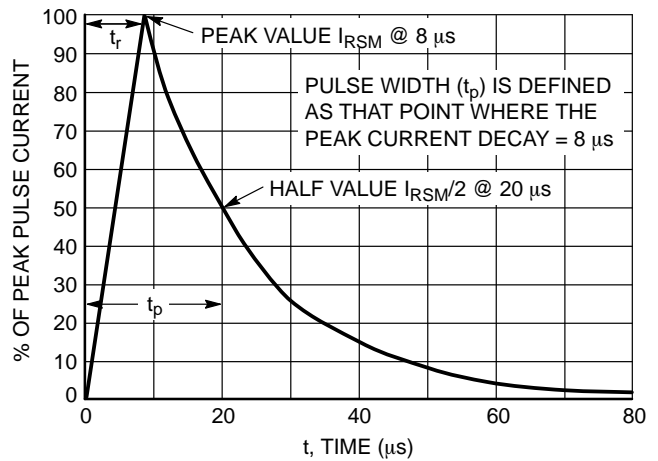

Figure 2. 8 X 20 μs Pulse Waveform

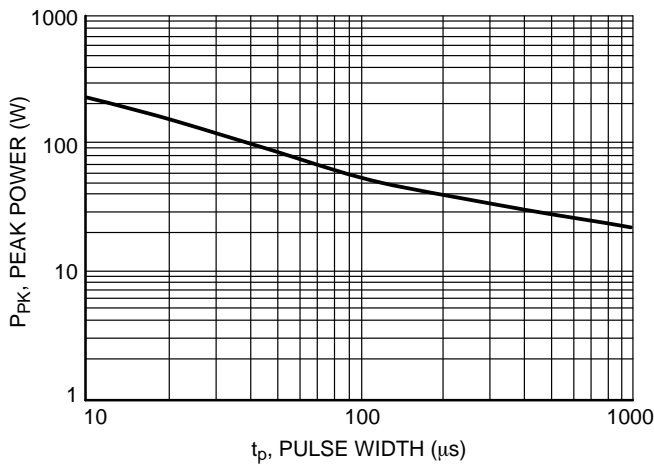

Figure 3. Pulse Rating Curve

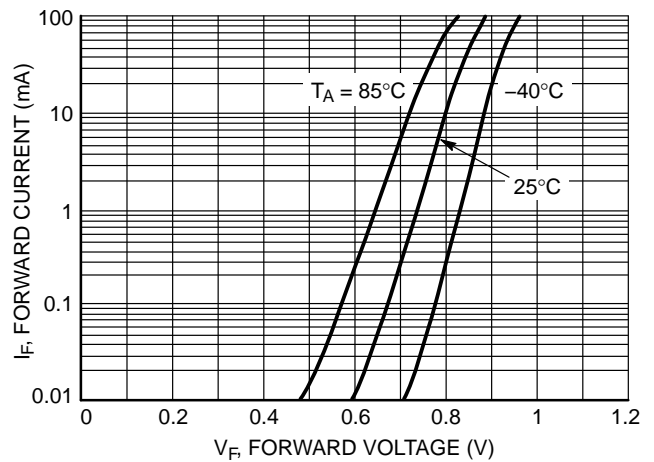

Figure 4. Forward Current versus Forward Voltage

MA3075WALT1G, SZMA3075WALT1G

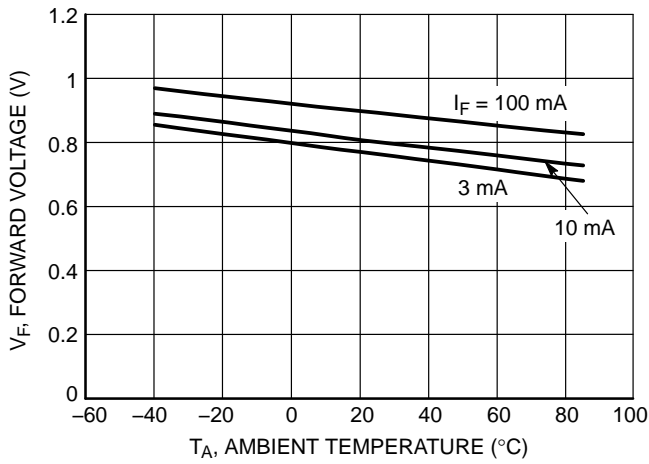

Figure 5. Forward Voltage versus Temperature

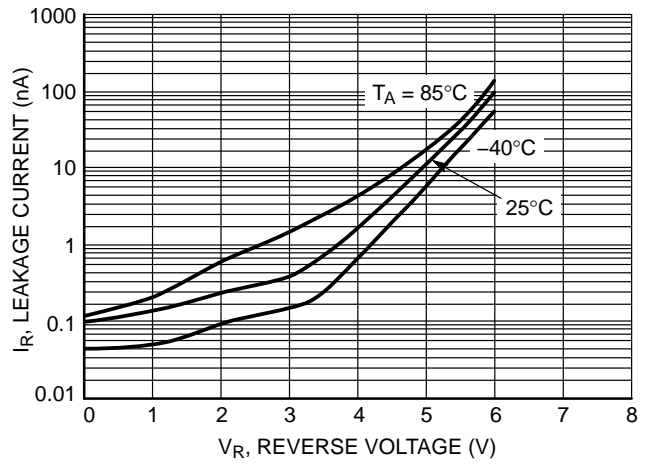

Figure 6. Leakage Current versus Reverse Voltage

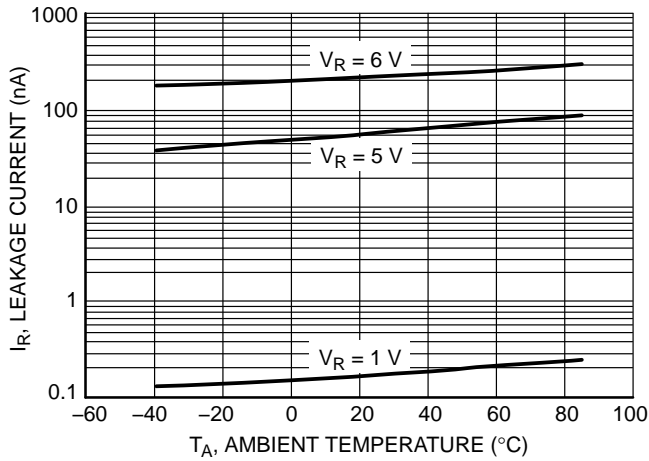

Figure 7. Leakage Current versus Temperature

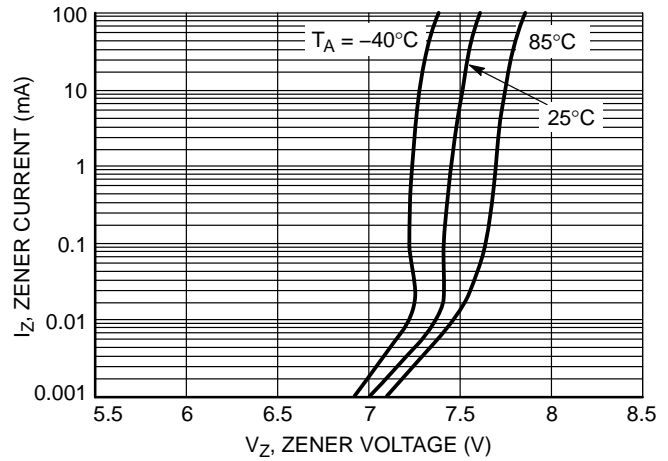

Figure 8. Zener Current versus Zener Voltage

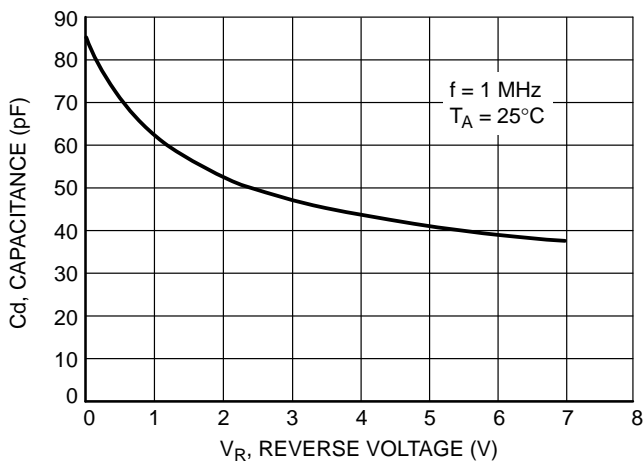

Figure 9. Capacitance

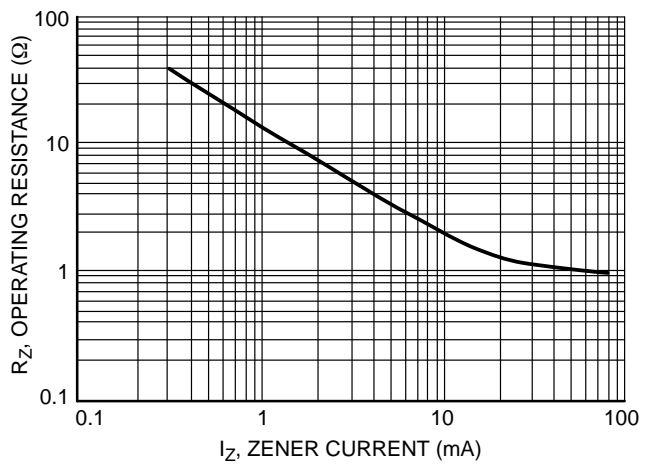
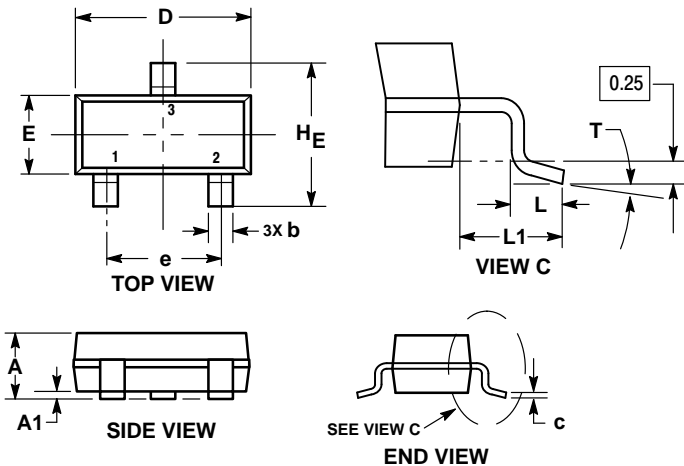

Figure 10. Operating Resistance versus Zener Current

MA3075WALT1G, SZMA3075WALT1G

SOT-23 (TO-236)
CASE 318-08
ISSUE AR



- NOTES:
1. DIMENSIONING AND TOLERANCING PER ASME Y14.5M, 1994.
 2. CONTROLLING DIMENSION: MILLIMETERS.
 3. MAXIMUM LEAD THICKNESS INCLUDES LEAD FINISH. MINIMUM LEAD THICKNESS IS THE MINIMUM THICKNESS OF THE BASE MATERIAL.
 4. DIMENSIONS D AND E DO NOT INCLUDE MOLD FLASH, PROTRUSIONS, OR GATE BURRS.

DIM	MILLIMETERS			INCHES		
	MIN	NOM	MAX	MIN	NOM	MAX
A	0.89	1.00	1.11	0.035	0.039	0.044
A1	0.01	0.06	0.10	0.000	0.002	0.004
b	0.37	0.44	0.50	0.015	0.017	0.020
c	0.08	0.14	0.20	0.003	0.006	0.008
D	2.80	2.90	3.04	0.110	0.114	0.120
E	1.20	1.30	1.40	0.047	0.051	0.055
e	1.78	1.90	2.04	0.070	0.075	0.080
L	0.30	0.43	0.55	0.012	0.017	0.022
L1	0.35	0.54	0.69	0.014	0.021	0.027
HE	2.10	2.40	2.64	0.083	0.094	0.104
T	0°	---	10°	0°	---	10°

STYLE 12:
PIN 1. CATHODE
2. CATHODE
3. ANODE

RECOMMENDED SOLDERING FOOTPRINT*

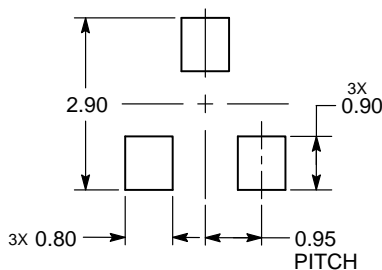

DIMENSIONS: MILLIMETERS

*For additional information on our Pb-Free strategy and soldering details, please download the ON Semiconductor Soldering and Mounting Techniques Reference Manual, SOLDERRM/D.

ON Semiconductor and are trademarks of Semiconductor Components Industries, LLC dba ON Semiconductor or its subsidiaries in the United States and/or other countries. ON Semiconductor owns the rights to a number of patents, trademarks, copyrights, trade secrets, and other intellectual property. A listing of ON Semiconductor's product/patent coverage may be accessed at www.onsemi.com/site/pdf/Patent-Marking.pdf. ON Semiconductor reserves the right to make changes without further notice to any products herein. ON Semiconductor makes no warranty, representation or guarantee regarding the suitability of its products for any particular purpose, nor does ON Semiconductor assume any liability arising out of the application or use of any product or circuit, and specifically disclaims any and all liability, including without limitation special, consequential or incidental damages. Buyer is responsible for its products and applications using ON Semiconductor products, including compliance with all laws, regulations and safety requirements or standards, regardless of any support or applications information provided by ON Semiconductor. "Typical" parameters which may be provided in ON Semiconductor data sheets and/or specifications can and do vary in different applications and actual performance may vary over time. All operating parameters, including "Typicals" must be validated for each customer application by customer's technical experts. ON Semiconductor does not convey any license under its patent rights nor the rights of others. ON Semiconductor products are not designed, intended, or authorized for use as a critical component in life support systems or any FDA Class 3 medical devices or medical devices with a same or similar classification in a foreign jurisdiction or any devices intended for implantation in the human body. Should Buyer purchase or use ON Semiconductor products for any such unintended or unauthorized application, Buyer shall indemnify and hold ON Semiconductor and its officers, employees, subsidiaries, affiliates, and distributors harmless against all claims, costs, damages, and expenses, and reasonable attorney fees arising out of, directly or indirectly, any claim of personal injury or death associated with such unintended or unauthorized use, even if such claim alleges that ON Semiconductor was negligent regarding the design or manufacture of the part. ON Semiconductor is an Equal Opportunity/Affirmative Action Employer. This literature is subject to all applicable copyright laws and is not for resale in any manner.

PUBLICATION ORDERING INFORMATION

LITERATURE FULFILLMENT:
Literature Distribution Center for ON Semiconductor
19521 E. 32nd Pkwy, Aurora, Colorado 80011 USA
Phone: 303-675-2175 or 800-344-3860 Toll Free USA/Canada
Fax: 303-675-2176 or 800-344-3867 Toll Free USA/Canada
Email: orderlit@onsemi.com

N. American Technical Support: 800-282-9855 Toll Free
USA/Canada
Europe, Middle East and Africa Technical Support:
Phone: 421 33 790 2910
Japan Customer Focus Center
Phone: 81-3-5817-1050

ON Semiconductor Website: www.onsemi.com
Order Literature: <http://www.onsemi.com/orderlit>

For additional information, please contact your local Sales Representative