

# TELEDYNE SOLID STATE

## MILITARY SOLID STATE RELAY

OPTICALLY ISOLATED

DC OUTPUT

UP TO 350ma, 400Vdc

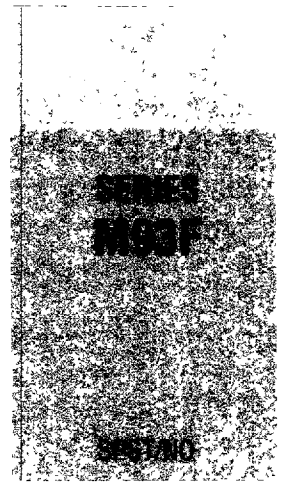

### FEATURES

- Optical isolation- Isolates control elements from load transients
- Fully Floating Output- Eliminates ground loops and allows the output to sink or source current
- Power FET Output- low output voltage drop with virtually no offset
- Buffered Control- Relay can be controlled directly from TTL or CMOS logic circuits
- Controlled Rise and Fall Times- Minimizes EMI generated by switching transients

### DESCRIPTION

The M93F series relays are designed for use in both dc switching applications. These relays utilize power FETs for the output switch, with blocking capability of up to 400V. The use of power FETs also eliminates the bipolar offset voltage normally associated with solid state relays, thus making these relays ideal for low level signal operation. Optical isolation protects the control logic from load transients and allows the output to sink or source current to the load. The input circuit incorporates a current limiter and a buffer to minimize power dissipation and allow direct operation from CMOS or TTL circuits.

The M93F series are packaged in low profile Centigrad packages which conserve board space in high density packaging applications.

PART NUMBER*	DESC NUMBER	RELAY TYPE
M93F-1W		SOLID STATE RELAY
M93F-1Y	85092-001	100Vdc
M93F-2W		SOLID STATE RELAY
M93F-2Y	85092-002	400Vdc

\*The W or Y suffix denotes the screening level of MIL-R-28750.

### OUTLINE DIMENSIONS

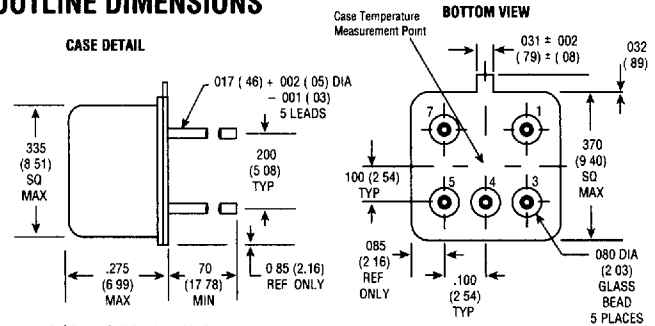

Weight: 2 GRAMS (MAX) All Dimensions in inches (millimeters)

### WIRING DIAGRAM

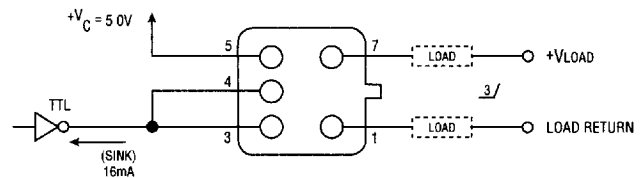

2 TERMINAL INPUT CONFIGURATION

### BLOCK DIAGRAM

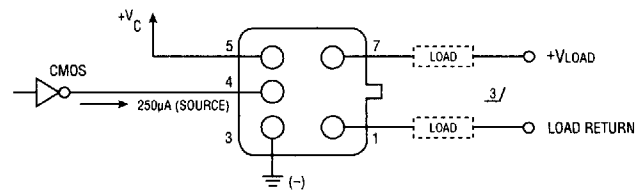
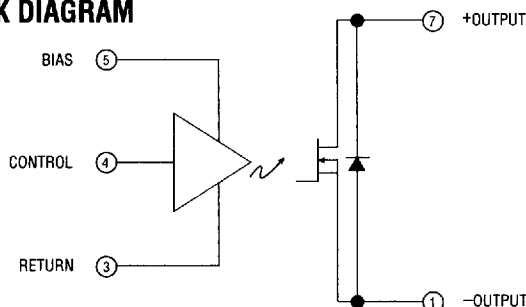

3 TERMINAL (BUFFERED) INPUT CONFIGURATION

SCHEMATIC (BOTTOM VIEW)

**SERIES M93F**

<b>ELECTRICAL SPECIFICATIONS</b> (-55°C to + 110°C UNLESS OTHERWISE SPECIFIED)				
<b>INPUT (CONTROL) CHARACTERISTICS</b> When used in 2 terminal configuration (TTL or direct control)				
	<b>MIN</b>	<b>TYP</b>	<b>MAX</b>	<b>UNITS</b>
Input Current @ VBIAS = 5 Vdc See Fig. 1		14	15	mAdc
Turn-Off Voltage (Guaranteed Off)			1.5	Vdc
Turn-On Voltage (Guaranteed On)	3.8			Vdc
Reverse Voltage Protection			-32	Vdc
Input Supply Range See Note 4	3.8		32	Vdc
<b>INPUT (CONTROL) CHARACTERISTICS</b> When used in 3 terminal configuration (CMOS or open collector TTL) See Fig. 2				
	<b>MIN</b>	<b>TYP</b>	<b>MAX</b>	<b>UNITS</b>
Control Current	VCONTROL = 5 Vdc		250	μAdc
	VCONTROL = 18 Vdc		1	mAdc
Control Voltage Range	0		18	Vdc
Bias Supply Voltage Range See Note 1	3.8		32	Vdc
Bias Supply Current		14	16	mAdc
Turn Off Voltage (Guaranteed Off)	3.2			Vdc
Turn On Voltage (Guaranteed On)			0.35	Vdc
Schmitt Hysteresis	0.7			Vdc
<b>OUTPUT (LOAD) SPECIFICATION</b> (See Note 5)				
	<b>MIN</b>	<b>TYP</b>	<b>MAX</b>	<b>UNITS</b>
Continuous Load Current (See Fig. 2)	M93F-1		350	mAdc
	M93F-2		135	mAdc
Leakage Current VLOAD = 80% Max. Rated			50	μA
Continuous Operating Load Voltage	M93F-1		100	Vdc
	M93F-2		400	Vdc
On Resistance ILOAD = 100 mA TJ = 25°C	M93F-1		4	Ohms
	M93F-2		25	Ohms
Turn-On Time			1	ms
Turn-Off Time			0.7	ms
Dielectric Strength	1000			Vac
Insulation Resistance @ 500 Vdc	10 <sup>9</sup>			Ohms
Output Junction Temperature @ ILOAD = maximum rated current			125	°C
Maximum Junction Temperature			150	°C

<b>ENVIRONMENTAL SPECIFICATIONS*</b>	
Temperature (Ambient Operating)	-55°C to Maximum Per Thermal Operating Curve
Temperature (Ambient Storage)	-55°C to 125°C
Vibration	100g, 10 to 3000 Hz
Acceleration	5000 g
Shock	1500g, 0.5 msec

\*Contact factory for higher level environmental requirements.

**NOTES:**

- Used in the 3 terminal input configuration, the relays provide inversion such that when the control voltage is 0.5 VDC or less, the relay's output will be guaranteed "on". When the control voltage is 2.8 VDC or more the relays output will be guaranteed "off".
- In the 2 terminal configuration the relays are non-inverting. When the TTL driving gate is sinking the drive current the relay output will be on.
- Relays may drive loads connected to either positive or negative referenced power supply lines. (Source or sink modes.)
- If the Series Control/Bias Resistor of figure 3 is used to dissipate Input Power, the derating of Output Current vs. Bias/Control Voltage is not necessary. Curve at 4 volts applies.
- The rated input voltage is 5V for all tests unless otherwise specified
- For on state resistance at temperature other than 25°C, use the following equation:  $R = R_{25} \times e^{0.006 \times \Delta T}$

where R25 = resistance at 25°C from table  
 R = resistance at new temperature  
 $\Delta T$  = new temperature - 25°C  
 e = 2.7182818

SPECIFICATIONS SUBJECT TO CHANGE WITHOUT NOTICE

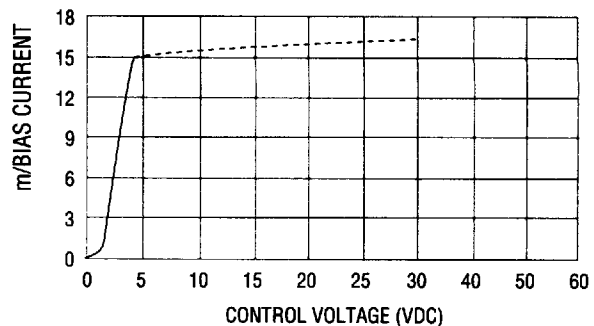

FIGURE 1 - CONTROL/BIAS CURRENT VS CONTROL/BIAS VOLTAGE

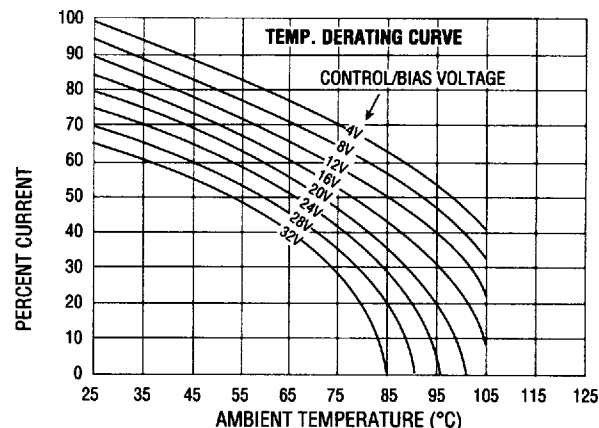

FIGURE 2 - MAXIMUM LOAD CURRENT VS AMBIENT TEMPERATURE

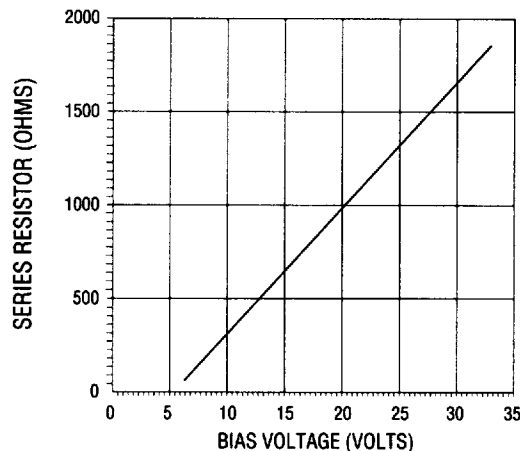

FIGURE 3 - SERIES LIMIT BIAS RESISTOR VS BIAS VOLTAGE