

HONEYWELL

See full Datasheet below...

onlinecomponents.com
THE ONLINE DISTRIBUTOR OF ELECTRONIC COMPONENTS

BUY NOW

 **MASTER**TM
E L E C T R O N I C S

BUY NOW

masterelectronics.com & onlinecomponents.com
are **authorized** e-commerce distributors
of electronic components.



MICRO SWITCH™
Hazardous Area Switches
LSX Series



MICRO SWITCH™ LSX Series Hazardous Area Limit Switches

MICRO SWITCH™ LSX hazardous area switches are designed for use in adverse environments. They are approved for use in hazardous locations and NEMA classified atmospheres because their rugged housings have integral flame paths. These flame paths force internal expanding gases to cool below external atmosphere ignition temperatures before they leave the housing. The LSX also features tracking interchangeability with MICRO SWITCH™ BX Series Hazardous Area switches. An optional mounting plate provides the same tracking and mounting as the standard HDLS Series (heavy-duty limit switch).

The majority of HDLS operating heads and circuitry options are available for the LSX Series. The rotary actuated LSX series products are designed for use with levers that have non-sparking actuators due to the potentially hazardous environment. The other styles of LSX Series switches which are the plunger actuated and wobble actuated products incorporate an integral non-sparking actuator.

What makes our switches better?

- Industry-leading breadth of product
- Weather sealed to NEMA 1, 3, 4, 6, 13
Explosion proof to NEMA 7 (Class 1, Division 1 & 2, Groups B, C, D),
NEMA 9 (Class 2, Division 1 & 2, Groups E, F, G)
- Extensive variety of actuation heads and multiple non-sparking actuators
- All metal drive train that offers consistent operating characteristics through a broad temperature range. Also lasts longer (without need for frequent adjustment) than drive trains with plastic parts



SAFE • RELIABLE
EXPLOSION PROOF • WEATHER SEALED

Features and Benefits

DESIGN FLEXIBILITY

MICRO SWITCH™ LSX limit switches' field adjustability (CW-CCW operation, rotatable operating head) assists in matching the switch to the application. Available with momentary, maintained, sequential, or center neutral action.

All-metal drive train for consistent operation

UNIQUE DESIGN FEATURES

The head design is keyed for more **secure head-to-body retention** with the head indexable in any one of four positions 90° apart. Captive mounting screws in the heads help prevent the loss of screws during replacement or repositioning of the head. Self-lifting pressure plate terminals **save wiring time**.

Industry-leading breadth of products

WITHSTANDS MANY CAUSTIC ENVIRONMENTS

A **die-cast zinc head** and aluminum body make the LSX suitable for indoor and outdoor applications. A **diaphragm seal** between the head and body is designed to provide an extra measure of protection. Switches remain functional when exposed to many severe environments and caustic chemicals.

OPTIONAL SEALS

Standard seals are suitable for most applications, but **optional fluorocarbon or fluorosilicone seals** are available for many harsh chemical, high or low temperature environments.

DESIGNED TO CONTROL LOW-VOLTAGE DC APPLICATIONS

Hazardous area switches are available with a choice of **silver or gold-plated contacts** to handle a variety of electrical load requirements from low energy to power-duty control.

Potential Applications



GRAIN ELEVATORS

Monitors plugged grain conveyors, slide gate position, diverter valves, and leg positions

CONTROL VALVES AND ACTUATORS

Senses the “on” or “off” position of the valve

ON-SHORE DRILLING

Detects end of travel positions for extend and retract operations of drilling equipment



PIPELINES

Monitors pig position and resulting pipeline health

PETROCHEMICAL AND CHEMICAL PLANTS

Monitors the position of control valves, doors, and gates

WATER TREATMENT PLANTS

Detects control valve position



PAINT BOOTHS

Door interlocks for sliding or hinged gates or doors

HAZARDOUS WASTE HANDLING

Often used as a valve position monitor

MICRO SWITCH™ Hazardous Area Limit Switches

Figure 1. MICRO SWITCH™ LSX SERIES FEATURES AND OPTIONS

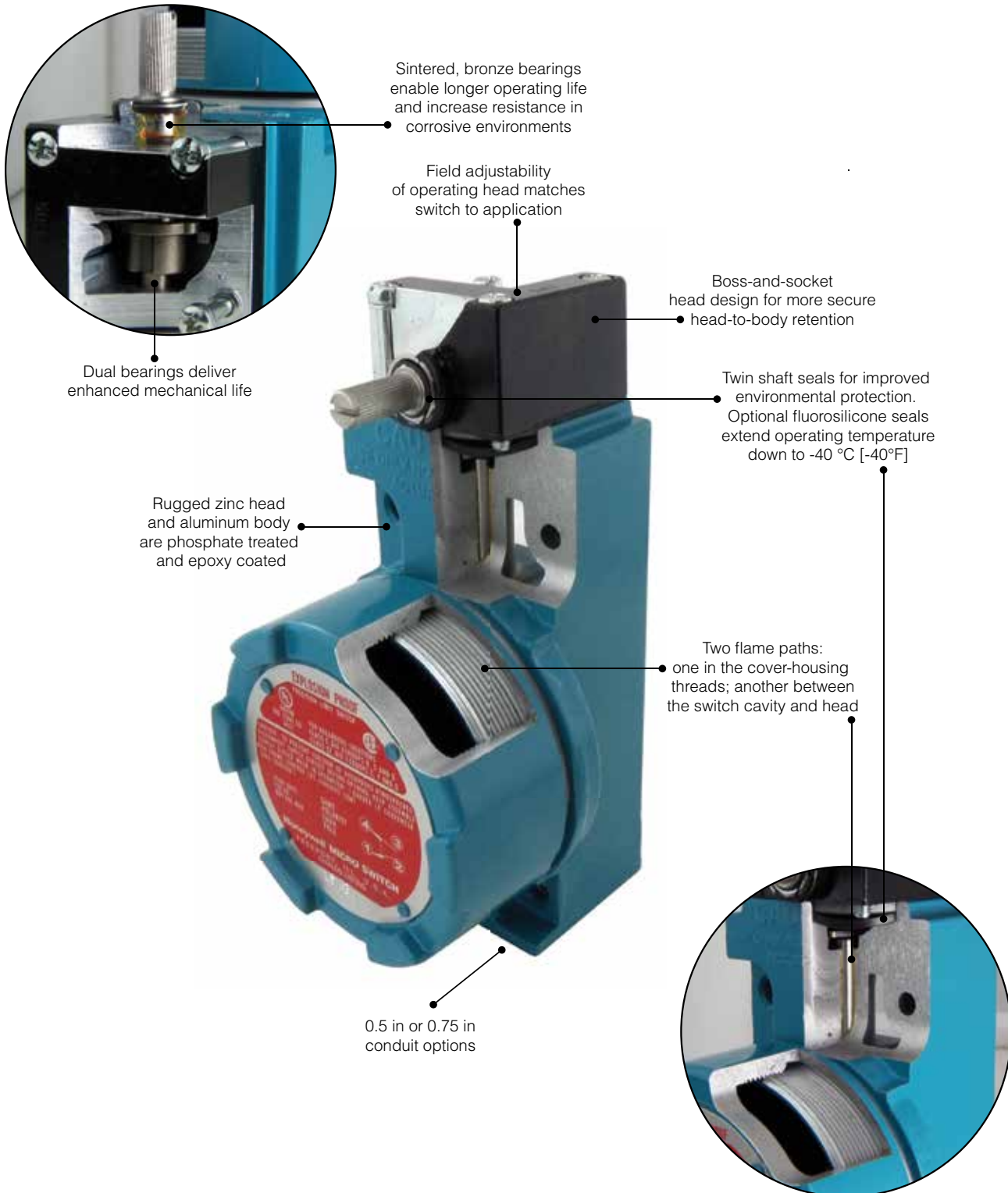

LSX Series

Figure 2. MICRO SWITCH™ LSX SERIES NOMENCLATURE

LSX	J	3K		7A
Switch Type	Head Style	Circuitry and Conduit Connection	Modification Code	Actuator Options**
LSX Series Hazardous Area Switch	A Side rotary; momentary	3E 1NO/1NC, gold contacts, 1/2-14NPT	1 CW rotation	1 Fixed roller, 1.5 in radius
	B Top rotary; momentary	3K 1NO/1NC, 1/2-14NPT	2 CCW rotation	1A Fixed 0.75 in x 0.25 in nylon roller, 1.5 in radius
	C Top plunger, plain	3N SPNC direct acting, 1/2-14NPT	3 Head assembled with actuator to right side	1C Fixed 0.75 in x 0.25 in nylon roller, 1.5 in radius
	D Top plunger, roller	4K 1NO/1NC, 3/4-14NPT	4 Head assembled with actuator to left side	2 Adjustable, rollerless
	E Side plunger plain; momentary	4L 2NO/2NC, 3/4-14NPT	5 Head assembled with actuator toward mounting surface	2A Adjustable, 0.75 in x 0.25 in nylon roller
	F Side plunger roller; momentary	4M 2NO/2NC, 3/4-14NPT, sequential operation	6 Roller perpendicular to mounting surface	2C Adjustable, 0.75 in x 0.25 in nylon roller
	H Side rotary, momentary; low PT, low torque	4N 2NO/2NC, 3/4-14NPT, center neutral	8 Roller on side plunger in vertical position	2J Adjustable, 1.0 in x 0.5 in nylon roller
	J Wobble stick	4S 2NO/2NC, gold contacts, 3/4-14NPT		2K Adjustable, 0.5 in x 0.25 in nylon roller
	K Whisker	4T 2NO/2NC, gold contacts, 3/4-14NPT, sequential operation		3E Yoke, 0.75 in x 0.25 in nylon roller
	L Side rotary; sequential	4U 2NO/2NC, gold contacts, 3/4-14NPT, center neutral		3M Yoke, 0.75 in x 0.25 in nylon roller
	M Side rotary; central neutral	7L 2NO/2NC, 1/2-14NPT		3S Yoke, 0.75 in x 0.25 in nylon roller, same side
	N Side rotary; maintained	7M 2NO/2NC, 1/2-14NPT, sequential operation		4 Hub only
	P Side rotary, momentary; low PT and DT	7N 2NO/2NC, 1/2-14NPT, center neutral		4M Hub rod, aluminum
	R Side rotary, momentary; low torque	7S 2NO/2NC, gold contacts, 1/2-14NPT		5 Offset, rollerless
	U Side rotary, low pre-travel	7T 2NO/2NC, gold contacts, 1/2-14NPT, sequential operation		5A Offset, 0.75 in x 0.25 in nylon roller
	V Top plunger, adjustable	7U 2NO/2NC, gold contacts, 1/2-14NPT, center neutral		5C Offset, 0.75 in x 0.25 in nylon roller
	W Side plunger, adjustable			7A Plastic wobble stick

Not all combinations available. Please contact Honeywell for assistance.
 ** Levers can be ordered separately. See Levers for Side Rotary Actuated Switches table

To order high temperature versions, insert the additional letters **Y** and **C** in the appropriate places in the standard catalog listing, as shown below:

LSXA3K	standard, side-rotary plug-in switch
LSXYAC3K	completely FC-sealed version of LSXA3K

To order low temperature versions, insert the additional letters **Y** and **B** in the appropriate places in the standard catalog listing, as shown below:

LSXA3K	standard, side-rotary plug-in switch
LSXYAB3K	low-temperature version of LSXA3K

For more details, please see page 8.

MICRO SWITCH™ Hazardous Area Limit Switches

Table 1. Specifications

Characteristic	Parameter
Product type	MICRO SWITCH™ hazardous area limit switches
Actuators	side pin plunger side rotary top pin plunger - adjustable wobble - cat whisker side pin plunger - adjustable side rotary maintained top roller plunger wobble - plastic rod side roller plunger top pin plunger top rotary
Circuitry	1NC 1NO SPDT snap action, double break 2NC 2NO DPDT snap action, double break 2NC 2NO DPDT snap action, double break, sequential 2NC 2NO DPDT snap action, double break, center neutral
Electrical	10 A thermal single and double pole: AC15 A600, AC15 B600; DC13 R300 (see table on page 8)
Housing material	zinc head, aluminum body
Termination types	0.5 in - 14 NPT conduit 0.75 in - 14 NPT conduit
Housing type	LSX non-plug-in
Agency approvals and standards	UL, CSA
Sealing	NEMA 1, 3, 4, 6, 13
Hazardous area designations	NEMA 7 (Class 1, Division 1 & 2, Groups B, C, D), NEMA 9 (Class 2, Division 1 & 2, Groups E, F, G)
Operating temperature*	standard: -12 °C to 121 °C [10 °F to 250 °F] optional: -40 °C to 121 °C [-40 °F to 250 °F]
UNSPSC code	39122213
UNSPSC commodity	39122213 Limit Switch

* Reference operating head styles on page 9 and 10 for exceptions.

LSX Series

MICRO SWITCH™ LSX SERIES ELECTRICAL RATINGS: 10 A CONTINUOUS CARRY ac VOLTS; PILOT DUTY: AC15, A600

Electrical Rating	Circuitry	Vac	Amps at 0.35 Power Factor Make	Amps at 0.35 Power Factor Break
AC15, A600	SPDT DPDT	120	60	6
		240	30	3
		480	15	1.5
		600	12	1.2

MICRO SWITCH™ LSX SERIES ELECTRICAL RATINGS: dc VOLTS; PILOT DUTY: DC13, R300

Electrical Rating	Circuitry	Vdc	Make & Break Amps Inductive	Make & Break Amps Resistive
DC13, R300	SPDT DPDT	120	0.25	0.8
		240	0.15	0.4

MICRO SWITCH™ LSX limit switches are capable of the following low voltage dc loads

Circuitry	Vdc	Amps Inductive	Amps Resistive
SPDT, DPDT	24	10	10

SWITCH CONTACT STYLES, DOUBLE BREAK

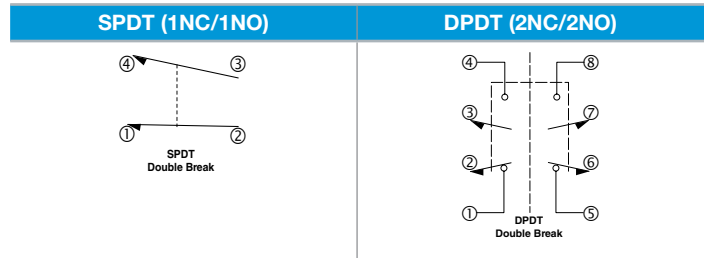

Center Neutral (SPDT each direction)
Pole 1 operates CCW; Pole 2 operates CW

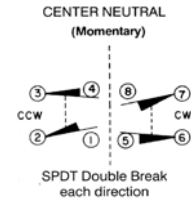

NOTE: Same polarity each pole

TEMPERATURE LIMITS

	Standard LSX				Low Temperature LSX (Fluorosilicone Sealed): Y_B				High Temperature LSX (Fluorocarbon Sealed)*: Y_C		
	Low Limit		High Limit		Low Limit		High Limit		Low Limit	High Limit	
	-12 °C [10 °F]	-1 °C [30 °F]	93 °C [200 °F]	121 °C [250 °F]	-40 °C [-40 °F]	-29 °C [-20 °F]	93 °C [200 °F]	121 °C [250 °F]	-12 °C [10 °F]	-1 °C [30 °F]	121 °C [250 °F]
LSXA - Side Rotary Momentary	•			•	•			•	•		•
LSXB - Top Rotary		•		•		•		•		•	•
LSXC - Top Plain Plunger	•		•		•		•		•		•
LSXD - Top Roller Plunger	•		•		•		•		•		•
LSXE - Side Plain Plunger	•		•		•		•		•		•
LSXF - Side Roller Plunger	•		•		•		•		•		•
LSXH - Side Rotary, Low Diff, Low Torque		•		•		•		•		•	•
LSXJ - Wobble Stick	•		•		•		•		•		•
LSXK - Cat Whisker	•		•			•		•	•		•
LSXL - Side Rotary, Sequence	•			•	•			•	•		•
LSXM - Side Rotary, Center Neutral		•		•	•			•		•	•
LSXN - Side Rotary, Maintained		•		•		•		•		•	•
LSXP - Side Rotary, Low Diff	•			•	•			•	•		•
LSXR - Side Rotary, Low Torque		•		•		•		•		•	•
LSXU - Side Rotary, 5° Low Pretravel	•			•							•
LSXV - Top Adjustable Plunger	•		•		•		•		•		•
LSXW - Side Adjustable Plunger	•		•		•		•		•		•

* For LSX application wherein the upper temperature limit is normally above 93 °C [200 °F], extended switch life can be obtained by using completely fluorocarbon-sealed switches rather than standard LSX.

MICRO SWITCH™ Hazardous Area Limit Switches

SPECIAL OPTIONS

HIGH TEMPERATURE/CHEMICAL RESISTANT SWITCHES

Completely fluorocarbon (FC)-sealed switches have a full FC body gasket covering the switch cavity. Rotary types have an extra FC seal on the operating shaft, while plunger versions have FC boot seals. They are designed for use in applications where the environment includes fire-resistant synthetic fluids. In addition, the FC-sealed switches may be used with such industrial fluids as Cellulube, Fyrquell, Houghto-Safe, Pydraul, and other special cutting and hydraulic fluids. The additional FC seals also promote extended operating life for rotary-actuated LSX switches in applications where the temperatures are normally -12 °C to 121 °C [10 °F to 250 °F].

To order, insert the additional letters **Y** and **C** in the appropriate places in the standard catalog listing, as shown below:

LSXA3K	standard, side-rotary plug-in switch
LSXYAC3K	completely FC-sealed version of LSXA3K

LOW TEMPERATURE SWITCHES

All forms of LSX limit switches are also available in low-temperature construction. Design features include fluorosilicone diaphragm, shaft seals, and external boot seal (where applicable).

To order, insert the additional letters **Y** and **B** in the appropriate places in the standard catalog listing, as shown below:

LSXA3K	standard, side-rotary plug-in switch
LSXYAB3K	low-temperature version of LSXA3K

MICRO SWITCH™ LSX SERIES OPERATING HEADS

SIDE ROTARY: Heads may be positioned in any one of four positions, 90° increments. All are momentary action except maintained head (LSXN Series).



LSXA - Standard: 60° minimum overtravel, 15° maximum pretravel, 5° (single pole) and 7° (double pole) maximum differential travel.

LSXR - Low operating torque: 60° minimum overtravel, 15° maximum pretravel, 0.19 Nm [1.7 in-lb] maximum operating torque.

LSXN - Maintained contact: Maintained on counterclockwise rotation and reset on clockwise rotation, and vice versa.

LSXP - Low differential: 68° minimum overtravel, 9° maximum pretravel, 3° (single pole) and 4° (double pole) maximum differential travel.

LSXH - Low torque, low differential travel: 68° minimum overtravel. Features low operating torque and narrow differential travel.

LSXL - Sequence action: 48° minimum overtravel. Delayed action between operation of two poles.

LSXM - Center neutral: 57° minimum overtravel. One pole operates on the clockwise rotation, and the other pole on the counterclockwise rotation.

LSXU - Low pretravel: 5° max. pretravel, 70° min. overtravel.

TOP ROTARY: Available levers provide greater versatility. Heads may be positioned in any one of four positions, 90° increments. All are momentary action.



LSXB: With 100° minimum overtravel. Various levers that fit side rotary shafts may be used on the top rotary shaft. Switch is suitable for use when increased overtravel is required.



LSX Series

MICRO SWITCH™ LSX SERIES OPERATING HEADS



TOP PLUNGERS: Available with 4,83 mm [0.19 in] minimum overtravel. Top pin plungers are offered in pin plunger, an adjustable plunger, and a roller plunger.

	<p>LSXC - Top pin plunger: A copper alloy plunger for in-line actuating motion. Oil-tight seals on plunger and between the operating head and housing are designed to keep out coolant, dust, and chips. Momentary action.</p>
	<p>LSXD - Top roller plunger: A copper alloy roller plunger is adjustable to 90° angles to accept cam or slide operation from any of two directions. Boot seal on the plunger. Momentary action.</p>
	<p>LSXV - Adjustable top pin plunger: A copper alloy adjustable plunger is designed to simplify the application and decreases installation time. The operating points of the switch can be adjusted from 65,66 mm to 72,0 mm [2.585 in to 2.535 in]. Seals are the same as the pin plunger. Momentary action.</p>

SIDE PLUNGERS: Made of non-sparking copper alloy. Available with 4,83 mm [0.19 in] minimum overtravel. Side plungers are offered in plain plunger, an adjustable pin plunger, and a roller plunger.

	<p>LSXE - Side pin plunger: A copper alloy plunger for actuating motion inline with the plunger travel. Actuating head may be rotated in any of four positions, 90° apart. A boot seal on the plunger and a gasket seal between the head and housing is designed to keep out coolant, dust, and chips. Momentary action.</p>
	<p>LSXF - Side roller plunger: A copper alloy roller plunger fits close quarters under cams and slides. The head may be rotated in any of four positions, 90° apart. <u>The roller can be turned vertical or horizontal to the switch.</u> Boot seal on plunger. Momentary action.</p>
	<p>LSXW - Adjustable side pin plunger: Has the same features of the side plain plunger plus the means to adjust the operating points of the switch from 41 mm to 47,4 mm [1.615 in to 1.865 in]. Momentary action.</p>

WOBBLE LEVER ACTUATING HEADS: Heads come with either a Delrin® plastic rod or a copper alloy cat whisker. Any movement of the lever (except pull) will actuate the switch.

	
<p>LSXJ - Plastic rod: Recommended where possible scratching or marring by the actuator is to be avoided.</p>	<p>LSXK - Cat whisker: Copper alloy actuator designed for low operating force applications.</p>

MICRO SWITCH™ Hazardous Area Limit Switches

SIDE ROTARY • MICRO SWITCH™ LSX SERIES ORDER GUIDE/RECOMMENDED LISTINGS



Description	Standard (LSXA)		Low Differential (LSXP)		Low Torque (LSXR)	
	SPDT	DPDT	SPDT	DPDT	SPDT	DPDT
Pretravel	15° max.		9° max.		15° max.	
Differential travel	5° max.	7° max.	3° max.	4° max.	5° max.	7° max.
Overtravel	60° min.		66° min.		60° min.	
Operating torque	0,45 Nm [4 in-lb] max.		0,45 Nm [4 in-lb] max.		0,19 Nm [1.7 in-lb] max.	
Action	Momentary, CW, & CCW (Spring return)					
Operating temperature range²	-12 °C to 121 °C [10 °F to 250 °F]				-1 °C to 121 °C [30 °F to 250 °F]	

		Contacts	Conduit (NPT)			
SPDT		Silver	0.5 in	LSXA3K	LSXP3K	LSXR3K
		Silver	0.75 in	LSXA4K	LSXP4K	LSXR4K
		Gold ¹	0.5 in	LSXA3E	LSXP3E	LSXR3E
DPDT		Silver	0.5 in	LSXA7L	LSXP7L	LSXR7L
		Silver	0.75 in	LSXA4L	LSXP4L	LSXR4L
		Gold ¹	0.75 in	LSXA4S	LSXP4S	LSXR4S

¹ Gold-plated contacts

² Completely fluorocarbon sealed switches are preferred for use in temperatures above 93 °C [200 °F]. For low temperature or high temperature versions, see page 9.

LSX Series

SIDE ROTARY • MICRO SWITCH™ LSX SERIES ORDER GUIDE/RECOMMENDED LISTINGS



Contact closed ■
 Contact open □

Description	Maintained Contact (LSXN)		Low Torque (LSXH)	
	SPDT	DPDT	SPDT	DPDT
Pretravel	65° max.		9° max.	
Differential travel	40° max.		3° max.	4° max.
Overtravel	20° min.		66° min.	
Operating torque	0,45 Nm [4 in-lb] max.		0,19 Nm [1.7 in-lb] max.	
Action	Maintained		Momentary, CW, & CCW (Spring return)	
Operating temp. range²	-1 °C to 121 °C [30 °F to 250 °F] (for low temp or high temp versions, see page 9)			

		Contacts	Conduit (NPT)		
SPDT		Silver	0.5 in	LSXN3K	LSXH3K
		Silver	0.75 in	LSXN4K	LSXH4K
		Gold ¹	0.5 in	LSXN3E	LSXH3E
DPDT		Silver	0.5 in	LSXN7L	LSXH7L
		Silver	0.75 in	LSXN4L	LSXH4L
		Gold ¹	0.75 in	LSXN4S	LSXH4S

¹ Gold-plated contacts

² Completely fluorocarbon sealed switches are preferred for use in temperatures above 93 °C [200 °F]
 For low temperature or high temperature versions, see page 9.

MICRO SWITCH™ Hazardous Area Limit Switches

SIDE ROTARY • MICRO SWITCH™ LSX SERIES ORDER GUIDE/RECOMMENDED LISTINGS



	Center Neutral (LSXM)	Sequence Action (LSXL)
Description	Center Neutral (Pole 1 operates CCW; Pole 2 operates CW)	Sequential (Pole 1 operates before Pole 2, either CW, CCW, or both)
	DPDT	DPDT
Contact closed ■ Contact open □		
Pretravel	18° max.	1 st : 15°; 2 nd : additional 10°
Differential travel	10° max.	each pole: 5°
Overtravel	57° min.	48° min.
Operating torque	0,45 Nm [4 in-lb] max.	0,45 Nm [4 in-lb] max.
Action	CW & CCW (Spring return)	
Operating temp. range²	-1 °C to 121 °C [30 °F to 250 °F]	-12 °C to 121 °C [10 °F to 250 °F]

	Contacts	Conduit (NPT)		
DPDT 	Silver	0.5 in	LSXM7N	LSXL7M
	Silver	0.75 in	LSXM4N	LSXL4M
	Gold ¹	0.5 in	LSXM7U	LSXL7T
	Gold ¹	0.75 in	LSXM4U	LSXL4T

¹ Gold-plated contacts

² Completely fluorocarbon sealed switches are preferred for use in temperatures above 93 °C [200 °F]
For low temperature or high temperature versions, see page 9.

LSX Series

TOP ROTARY • MICRO SWITCH™ LSX SERIES ORDER GUIDE/RECOMMENDED LISTINGS















Description	Standard (LSXB)			
	Standard			
	<p>SPDT</p> <p>Snap Action 1NO/1NC</p>	<p>DPDT</p> <p>Snap Action 2NO/2NC</p>		
	<p>■ Contact closed</p> <p>□ Contact open</p>			
Pretravel	25° max.			
Differential travel	10° max.	12° max.		
Overtravel	110° min.			
Operating torque	0,25 Nm [2.5 in-lb]			
Action	Momentary, CW, & CCW (Spring return)			
Operating temp. range¹	-1 °C to 121 °C [30 °F to 250 °F] (for low temp or high temp versions, see page 9)			
	Contacts	Conduit (NPT)		
SPDT	 Silver	0.5 in	LSXB3K	-
	Silver	0.75 in	-	LSXB4L

¹ Completely fluorocarbon sealed switches are preferred for use in temperatures above 93 °C [200 °F]. For low temperature or high temperature versions, see page 9.

MICRO SWITCH™ Hazardous Area Limit Switches

Table 2. Common levers for use with MICRO SWITCH™ LSX Rotary Switches*

Levers for use with side-rotary-actuated switches are available in a wide choice of sizes and materials. The most common listings are shown below. Rollers may be on either side of the lever to best match the external actuating mechanism.





						
Fixed lever, nylon roller LSZ51A - front mount roller LSZ51C - back mount roller		Short fixed lever, nylon roller LSZ59A - front mount roller LSZ59C - back mount roller		Offset lever, nylon roller LSZ55A - back mount roller LSZ55C - front mount roller		
						
One-way lever, nylon roller LSZ60A - front mount roller		Yoke lever, nylon rollers LSZ53A - front/back mount rollers				
						
Adjustable lever, nylon roller LSZ52A - back mount roller LSZ52C - front mount roller	LSZ52J adjustable lever, nylon roller 25,4 mm [1 in]	LSZ52K adjustable lever, nylon roller 38,1 [1.5 in]	LSZ54M aluminum rod 140 mm [5.5 in]	LSZ61 loop 152 mm [6 in]	LSZ67CA** Plastic conveyor roller	LSZ68 rod with spring 305 mm [12 in]







* Non-sparking rollers and actuators must be used in hazardous areas.

** May require orientation of switch and lever to enable gravity to help restore switch's free position.

LSX Series

Table 3. LSX Series Lever Order Guide

Catalog Listing	Material	Roller Dia. mm [in]	Roller Width mm [in]	Roller Mounting
Fixed 38,1 mm [1.5 in] radius				
	LSZ51	Rollerless	n/a	n/a
	LSZ51A	Nylon	19 [0.75]	6,35 [0.25] Front
	LSZ51C	Nylon	19 [0.75]	6,35 [0.25] Back
	LSZ51F	Nylon	25,4 [1.0]	12,7 [0.50] Front
	LSZ51G	Nylon	38,1 [1.5]	6,35 [0.25] Front
	LSZ51J	Nylon	25,4 [1.0]	12,7 [0.50] Back
	LSZ51M	Nylon	19 [0.75]	31,7 [1.25] Back
	LSZ51P	Nylon	19 [0.75]	12,7 [0.50] Front
	LSZ251A (sst)	Nylon	19 [0.75]	6,35 [0.25] Front
	LSZ251C (sst)	Nylon	19 [0.75]	6,35 [0.25] Back
	LSZ251E (sst)	Copper alloy	19 [0.75]	6,35 [0.25] Front
	LSZ251F (sst)	Copper alloy	19 [0.75]	6,35 [0.25] Back
Adjustable 38,1 mm [1.5 in] to 89,9 mm [3.5 in] radius				
	LSZ52	Rollerless	n/a	n/a
	LSZ52A	Nylon	19 [0.75]	6,35 [0.25] Back
	LSZ52C	Nylon	19 [0.75]	6,35 [0.25] Front
	LSZ52E	Nylon	19 [0.75]	33,0 [1.30] Front
	LSZ52J	Nylon	25,4 [1.0]	12,7 [0.50] Front
	LSZ52K	Nylon	38,1 [1.5]	6,35 [0.25] Front
	LSZ52M	Nylon	50,8 [2.0]	6,35 [0.25] Front
	LSZ52N	Nylon	19 [0.75]	12,7 [0.50] Front
	LSZ252A (sst)	Nylon	19 [0.75]	6,35 [0.25] Front
	LSZ252C (sst)	Nylon	19 [0.75]	6,35 [0.25] Back
	LSZ252E (sst)	Copper alloy	19 [0.75]	6,35 [0.25] Front
	LSZ252F (sst)	Copper alloy	19 [0.75]	6,35 [0.25] Back
Yoke – 38,1 mm [1.5 in] radius				
	LSZ53A	Nylon	19 [0.75]	6,35 [0.25] Front/Back
	LSZ53E	Nylon	19 [0.75]	6,35 [0.25] Back/Front
	LSZ53M	Nylon	19 [0.75]	31,7 [1.25] Back/Front
	LSZ53S	Nylon	19 [0.75]	6,35 [0.25] Back/Back
Rod				
	LSZ54	Hub only	n/a	n/a
	LSZ54M	Alum., 140 mm [5.5 in]	Ø 3,2 [Ø 0.125]	n/a
	LSZ54N	Stainless, 330 mm [13 in]	Ø 3,2 [Ø 0.125]	n/a
	LSZ54P	Plastic rod, 305 mm [12 in]	Ø6,85 [Ø 0.27]	n/a
LSZ54W	Plastic rod, 183 mm [7.2 in]	Ø6,85 [Ø 0.27]	n/a	
Offset – 38,1 mm [1.5 in] radius				
	LSZ55	Rollerless	n/a	n/a
	LSZ55A	Nylon	19 [0.75]	6,35 [0.25] Back
	LSZ55C	Nylon	19 [0.75]	6,35 [0.25] Front
	LSZ55E	Nylon	19 [0.75]	12,7 [0.50] Front
	LSZ55K	Nylon	38,1 [1.5]	6,35 [0.25] Front

Catalog Listing	Material	Roller Dia. mm [in]	Roller Width mm [in]	Roller Mounting	
Short fixed - 33,02 mm [1.3 in] radius					
	LSZ59A	Nylon	19 [0.75]	6,35 [0.25] Front	
	LSZ59C	Nylon	19 [0.75]	6,35 [0.25] Back	
One-way roller lever					
	LSZ60A	Nylon	19 [0.75]	6,35 [0.25] Front	
Flexible loop					
	LSZ61	Ø 4,8 [Ø 0.19] Nylatron	152 mm [6 in] flexible loop		
	LSZ618	Ø 4,8 [Ø 0.19] Nylatron	241 mm [9.5 in] flexible loop		
	LSZ54	Hub only	n/a	n/a	n/a
Spring rod					
	LSZ68	Delrin rod, 305 mm [12 in]	Ø 6,35 [0.25]	n/a	n/a
	LSZ617	Delrin rod, 406 mm [16 in]	Ø 6,35 [0.25]	n/a	n/a
	LSZ686	Delrin rod, 152 mm [6 in]	Ø 6,35 [0.25]	n/a	n/a
Rubber roller levers					
	LSZ51Y	Rubber	50 [2.0]	12,7 [0.5]	front
	LSZ55Y	Rubber	50 [2.0]	12,7 [0.5]	front
	LSZ52Y	Rubber	50 [2.0]	12,7 [0.5]	front
Plastic roller levers					
	LSZ67AA (conveyor)*	Plastic	38,1 [1.5]	96,5 [3.8]	n/a



* May require orientation of switch and lever to enable gravity to help restore switch to free position.

MICRO SWITCH™ Hazardous Area Limit Switches

TOP PLUNGER • MICRO SWITCH™ LSX SERIES ORDER GUIDE/RECOMMENDED LISTINGS

All top plungers are momentary action.

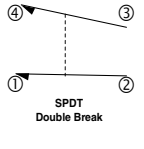
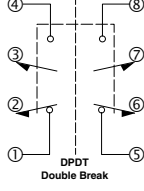

	Plain (LSXC)		Roller (LSXD)		Adjustable (LSXV)	
Description	 <p>Top plain plunger for in-line operating motion</p>		 <p>Top roller plunger – can be set at 90° increments to accept cam or slide actuation</p>		 <p>Adjustable top plain plunger simplifies installation since operating point can be adjusted from 65,66 mm min.; 72,0 mm max. [2.585 in min; 2.835 in max.]</p>	
Contact closed ■ Contact open □	SPDT	DPDT	SPDT	DPDT	SPDT	DPDT
	<p>1.78 mm [0.07 in] 1.4 mm [0.055 in] 6.6 mm [0.26 in]</p>	<p>1.4 mm [0.07 in] 1.27 mm [0.050 in] 6.6 mm [0.26 in]</p>	<p>1.78 mm [0.07 in] 1.4 mm [0.055 in] 6.6 mm [0.26 in]</p>	<p>1.4 mm [0.07 in] 1.27 mm [0.050 in] 6.6 mm [0.26 in]</p>	<p>1.78 mm [0.07 in] 1.4 mm [0.055 in] 6.6 mm [0.26 in]</p>	<p>1.4 mm [0.07 in] 1.27 mm [0.050 in] 6.6 mm [0.26 in]</p>
Pretravel	1,78 mm [0.07 in]					
Differential travel	0,38 mm [0.015 in]	0,51 mm [0.02 in]	0,38 mm [0.015 in]	0,51 mm [0.02 in]	0,38 mm [0.015 in]	0,51 mm [0.02 in]
Overtravel	4,83 mm [0.19 in]					
Opening force	17,8 N [4 lb] max.					
Operating point	58,55 mm ±0,76 mm [2.305 in ±0.030 in]		68,58 mm ±1,02 mm [2.70 in ±0.040 in]		65,66 mm min.; 72,0 mm max. [2.585 in min; 2.835 in max.]	
Operating temp. range²	-12 °C to 93 °C [10 °F to 200 °F] (for low temp or high temp versions, see page 9)					

	Contacts	Conduit (NPT)			
SPDT 	Silver	0.5 in	LSXC3K	LSXD3K	LSXV3K
	Silver	0.75 in	LSXC4K	LSXD4K	LSXV4K
	Gold ¹	0.5 in	LSXC3E	LSXD3E	LSXV3E
DPDT 	Silver	0.5 in	LSXC7L	LSXD7L	LSXV7L
	Silver	0.75 in	LSXC4L	LSXD4L	LSXV4L
	Gold ¹	0.75 in	LSXC4S	LSXD4S	LSXV4S

¹ Gold-plated contacts

² Completely fluorocarbon sealed switches are preferred for use in temperatures above 93 °C [200 °F] For low temperature or high temperature versions, see page 9.

LSX Series

SIDE PLUNGER • MICRO SWITCH™ LSX SERIES ORDER GUIDE/RECOMMENDED LISTINGS

All side plungers are momentary action. Heads may be positioned to accept actuation from any of four directions, 90° apart.



	Plain (LSXE)		Roller (LSXF)		Adjustable (LSXW)	
	SPDT	DPDT	SPDT	DPDT	SPDT	DPDT
Description	Side plain plunger for in-line operating motion		Side roller plunger – can be set at 90° increments to accept cam or slide actuation		Adjustable side plain plunger simplifies installation since operating point can be adjusted from 41 mm min.; 47,37 mm max. [1.615 in min.; 1.865 in max.]	
Contact closed ■ Contact open □						
Pretravel	2,54 mm [0.10 in]					
Differential travel	1,14 mm [0.045 in]					
Overtravel	4,83 mm [0.19 in]					
Operating force	26,7 N [6 lb] max.					
Operating point	33,02 mm ±0,76 mm [1.300 in ±0.030 in]		44,07 mm ±1,02 mm [1.735 in ±0.04 in]		41 mm min.; 47,37 mm max. [1.615 in min.; 1.865 in max.]	
Operating temp. range ²	-12 °C to 93 °C [10 °F to 200 °F] (for low temp or high temp versions, see page 9)					

		Contacts	Conduit (NPT)			
SPDT		Silver	0.5 in	LSXE3K	LSXF3K	LSXW3K
		Silver	0.75 in	LSXE4K	LSXF4K	LSXW4K
		Gold ¹	0.5 in	LSXE3E	LSXF3E	LSXW3E
DPDT		Silver	0.5 in	LSXE7L	LSXF7L	LSXW7L
		Silver	0.75 in	LSXE4L	LSXF4L	LSXW4L
		Gold ¹	0.75 in	LSXE4S	LSXF4S	LSXW4S

¹ Gold-plated contacts

² Completely fluorocarbon sealed switches are preferred for use in temperatures above 93 °C [200 °F] For low temperature or high temperature versions, see page 9.

MICRO SWITCH™ Hazardous Area Limit Switches

WOBBLE • MICRO SWITCH™ LSX SERIES ORDER GUIDE/RECOMMENDED LISTINGS



LSJ1A-7A
- Plastic
rod

LSK1A-
8A - Cat
whisker

Contact closed ■
Contact open □

Description	LSXJ Series 7A Actuator		LSXK Series 8A Actuator	
	SPDT	DPDT	SPDT	DPDT
Actuator length	152,4 mm [6 in]		139,7 mm [5.5 in] copper alloy	
Pretravel	25,4 mm [1.0 in]		51,0 mm [2.0 in]	
Operating force	2,78 Nm [10 oz]		1,39 Nm [5 oz]	
Operating temp. range²	-12 °C to 93 °C [10 °F to 200 °F] (for low temp or high temp versions, see page 9)			

		Contacts	Conduit (NPT)		
SPDT Double Break		Silver	0.5 in	LSXJ3K-7A	LSXK3K-8A
		Silver	0.75 in	LSXJ4K-7A	LSXK4K-8A
		Gold ¹	0.5 in	LSXJ3E-7A	LSXK3E-8A
DPDT Double Break		Silver	0.5 in	LSXJ7L-7A	LSXK7L-8A
		Silver	0.75 in	LSXJ4L-7A	LSXK4L-8A
		Gold ¹	0.75 in	LSXJ4S-7A	LSXK4S-8A

¹ Gold-plated contacts

² Completely fluorocarbon sealed switches are preferred for use in temperatures above 93 °C [200 °F]
For low temperature or high temperature versions, see page 9.

LSX Series

REPLACEMENT CONTACT BLOCKS

Circuitry	Replacement Contact Block
Single pole	LSXZ3K
Double pole	LSXZ3L
Sequence or central neutral	LSXZ3M

REPLACEMENT HEADS FOR STANDARD LSX SWITCHES

Switch Type	Catalog Listing/Operating Head Only
LSXA	LSZ1A
LSXB	LSZ1B
LSXC	LSXZ1C
LSXD	LSXZ1D
LSXE	LSXZ1E
LSXF	LSXZ1F
LSXH	LSZ1H
LSXJ	LSZ1JGA
LSXK	LSXZ1KHA
LSXL	LSZ1L
LSXM	LSZ1M
LSXN	LSZ1N
LSXP	LSX1P
LSXR	LSZ1R
LSXU	LSZ1U
LSXV	LSXZ1V
LSXW	LSXZ1W

ADAPTER PLATE

Catalog listing LSXZ4022 adapter plate enables the NEMA-rated, explosion-proof LSX Series to be mounted on existing HDLS mounting holes. The LSX has a recessed back into which the adapter plate fits and mounts, using two screws (furnished)

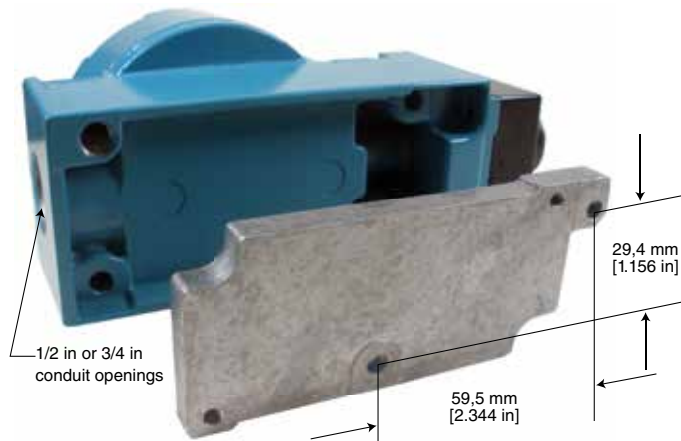

ASSEMBLY MODIFICATIONS

Momentary action rotary switches can be furnished in other than the normal assembled conditions. To specify modifications, add the numbers shown below to the catalog listings. Modification number suffixes are:

- 1 Clockwise actuation only
- 2 Counterclockwise actuation only
- 3 Shaft to right of switch front
- 4 Shaft to left of switch front
- 5 Shaft to back of switch

For example,

Catalog listing LSXA3K**23** is a LSXA3K switch adjusted for counterclockwise actuation only. The operating shaft is to the right side of the switch when viewing it from the front (label side). No lever.

PLUNGER ASSEMBLY MODIFICATIONS

Add the following modification numbers to the catalog listing in the plunger switch:

- 3 Side plunger to right of switch front
- 4 Side plunger to left of switch front
- 5 Side plunger to back of switch
- 6 Roller on top plungers perpendicular to mounting surface
- 8 Roller on side plungers in vertical position

For example,

Catalog listing LSXF3K**3** is a LSXF3K switch with the side roller plunger to the right side.

MICRO SWITCH™ Hazardous Area Limit Switches

Figure 3. MICRO SWITCH™ LSX SERIES PRODUCT REFERENCE DIMENSIONS • mm [in]
SIDE ROTARY - HEAD CODES: A, H, L, M, N, P, Q, R, AND U

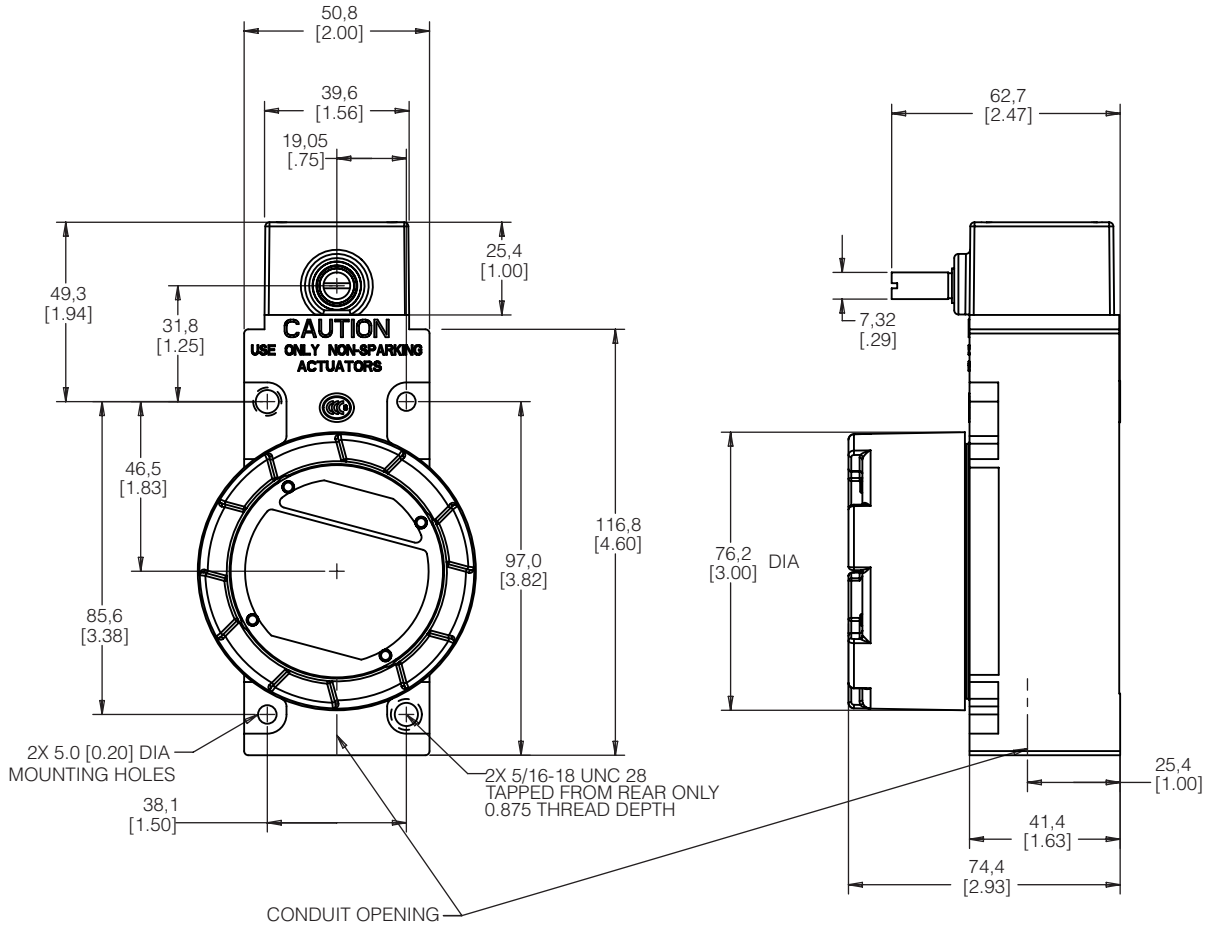

Figure 4. MICRO SWITCH™ LSX SERIES WOBBLE STICK, HEAD CODE J • mm [in]

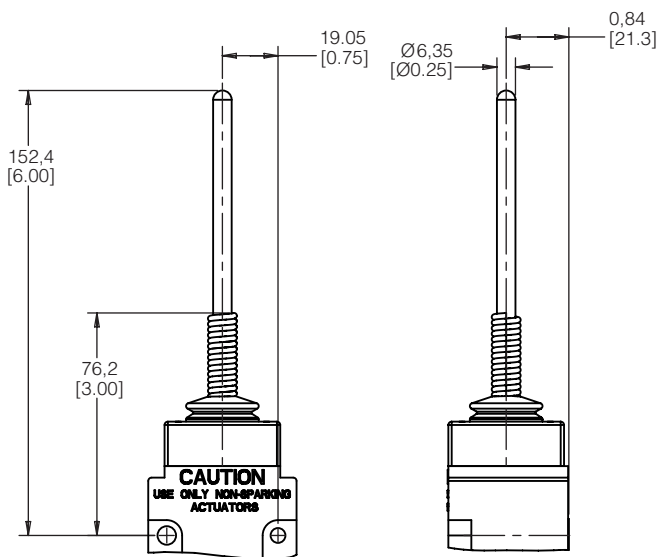
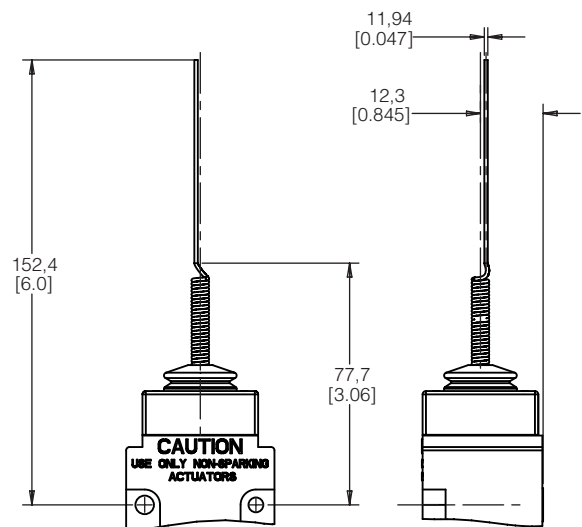

Figure 5. MICRO SWITCH™ LSX SERIES CAT WHISKER WOBBLE, HEAD CODE K • mm [in]



LSX Series

Figure 6. MICRO SWITCH™ LSX SERIES TOP ROTARY, HEAD CODE B • mm [in]

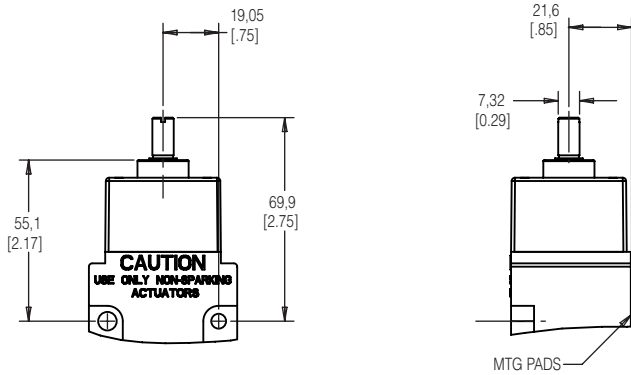

Figure 8. MICRO SWITCH™ LSX SERIES TOP ROLLER PLUNGER, HEAD CODE D • mm [in]

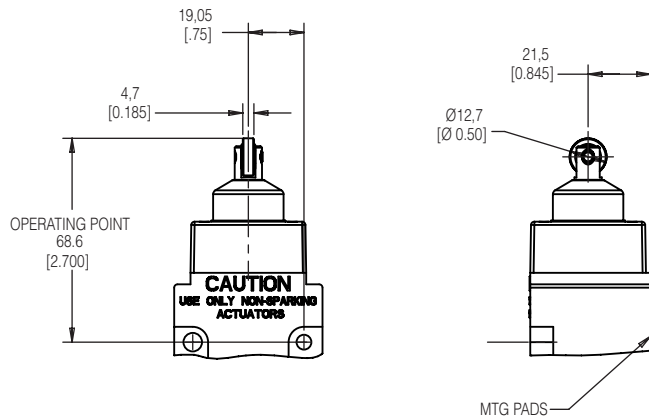

Figure 10. MICRO SWITCH™ LSX SERIES ADJUSTABLE TOP PIN PLUNGER, HEAD CODE V • mm [in]

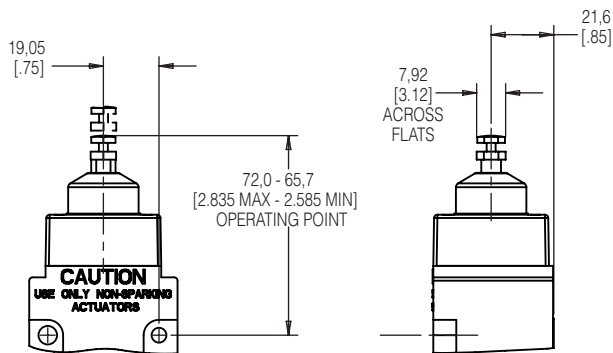

Figure 7. MICRO SWITCH™ LSX SERIES TOP PIN PLUNGER, HEAD CODE C • mm [in]

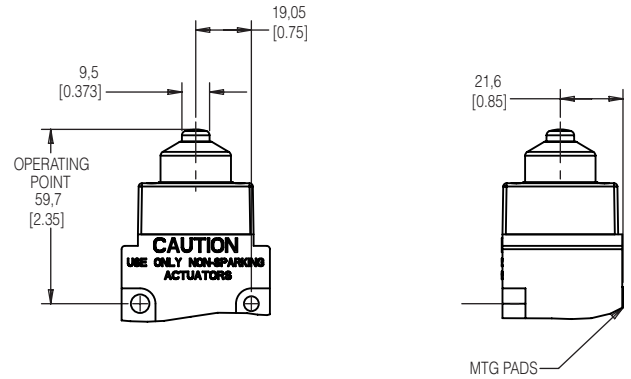

Figure 9. MICRO SWITCH™ LSX SERIES SIDE PLUNGER, HEAD CODE E • mm [in]

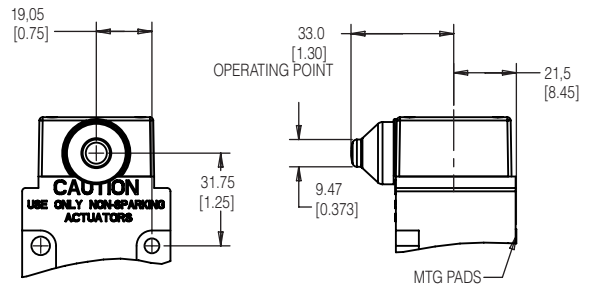

Figure 11. MICRO SWITCH™ LSX SERIES SIDE ROLLER PLUNGER, HEAD CODE F • mm [in]

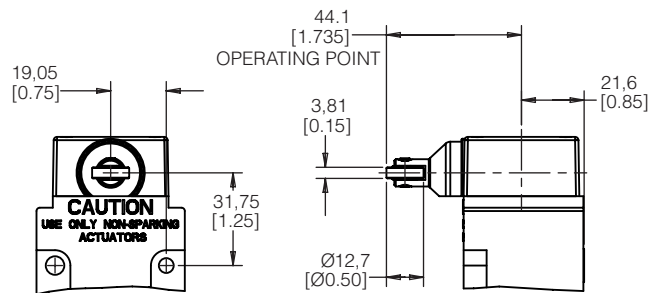
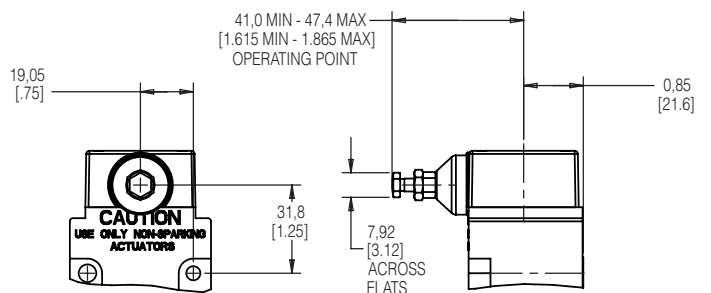

Figure 12. MICRO SWITCH™ LSX SERIES ADJUSTABLE SIDE PIN PLUNGER, HEAD CODE W • mm [in]



ADDITIONAL INFORMATION

The following associated literature is available on the Honeywell web site at sensing.honeywell.com:

- Product installation instructions
- Product range guide
- Hazardous area product brochure
- Product application-specific information
 - Application note: Electronic sensors and electromechanical switches in valves and flow meters
 - Application note: MICRO SWITCH™ switches in conveyor applications
 - Application note: Sensors and switches for industrial manual process valves
 - Application note: Sensors and switches used in valve actuators and valve positioners
 - Limit and enclosed switches reference standards
 - Sensors and switches in oil rig applications

Find out more

Honeywell serves its customers through a worldwide network of sales offices, representatives and distributors. For application assistance, current specifications, pricing or name of the nearest Authorized Distributor, contact your local sales office.

To learn more about Honeywell's sensing and switching products, call **+1-815-235-6847** or **1-800-537-6945**, visit **sensing.honeywell.com**, or e-mail inquiries to **info.sc@honeywell.com**

Honeywell Sensing and Productivity Solutions

9680 Old Bailes Road
Fort Mill, SC 29707
honeywell.com

002385-3-EN IL50 GLO
February 2016
Copyright © 2016 Honeywell International Inc. All rights reserved.

WARNING **PERSONAL INJURY**

DO NOT USE these products as safety or emergency stop devices or in any other application where failure of the product could result in personal injury.

Failure to comply with these instructions could result in death or serious injury.

WARNING **MISUSE OF DOCUMENTATION**

- The information presented in this product sheet is for reference only. Do not use this document as a product installation guide.
- Complete installation, operation, and maintenance information is provided in the instructions supplied with each product.

Failure to comply with these instructions could result in death or serious injury.

WARRANTY/REMEDY

Honeywell warrants goods of its manufacture as being free of defective materials and faulty workmanship. Honeywell's standard product warranty applies unless agreed to otherwise by Honeywell in writing; please refer to your order acknowledgement or consult your local sales office for specific warranty details. If warranted goods are returned to Honeywell during the period of coverage, Honeywell will repair or replace, at its option, without charge those items it finds defective. **The foregoing is buyer's sole remedy and is in lieu of all other warranties, expressed or implied, including those of merchantability and fitness for a particular purpose. In no event shall Honeywell be liable for consequential, special, or indirect damages.**

While we provide application assistance personally, through our literature and the Honeywell website, it is up to the customer to determine the suitability of the product in the application.

Specifications may change without notice. The information we supply is believed to be accurate and reliable as of this printing. However, we assume no responsibility for its use.

Honeywell