

Part Number	Description
LS24D16C	16A, 240 Vac
LS60D22C	22A, 600 Vac
LS24D27C	27A, 240 Vac
LS60D30C	30A, 600 Vac

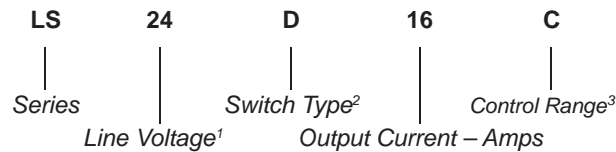

Part Number Explanation



NOTES

- 1) Line Voltage (nominal) 24 = 240 Vac; 60 = 600 Vac
- 2) Switch Type: D = Zero-cross turn-on
- 3) Control Range: C = 4-14 Vdc

MECHANICAL SPECIFICATION

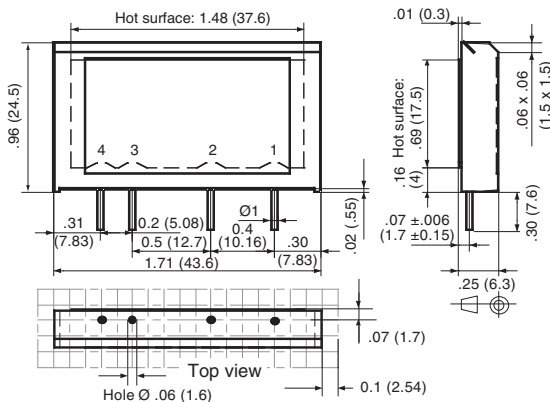

WEIGHT: 0.53 oz. (15g) TOLERANCES: ±.007 (±0.2mm)

Figure 1 - LS relays; dimensions in inches (mm)
(See Figure 12 for LS with HS1)

TYPICAL APPLICATION

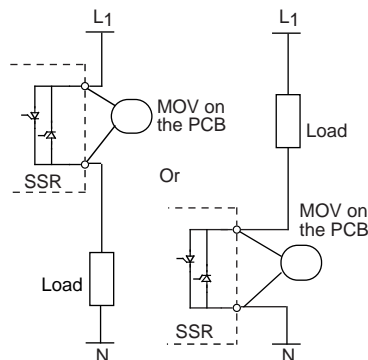

Figure 2 — LS relays

FEATURES/BENEFITS

- Industry standard package
- Designed for external heat-sink attachment
- Over-sized thyristor ratings
- Direct-copper bonding technology

DESCRIPTION

These solid-state single inline package (SIP) relays are designed for mounting on printed circuit boards. The Series LS relays facilitate heat sinking by providing an interface surface. The relays are designed with 16A, 25A and 50A thyristors. They can switch loads with high starting currents. The nominal switched currents depend on the size of the heat sink and are limited by the cross section of the tracks of the printed circuit (mainly 25A/30A). The relays use a direct-bonded copper substrate for thermal efficiency, thermal stress performance and long-life expectancy.

APPLICATIONS

- Motor control — Pumps, reversing, integration of relays in terminal boxes
- Lamp control — Infrared drying, traffic lights, theater lighting

APPROVALS

All models are UL recognized.
UL File Number: E128555.

BLOCK DIAGRAM

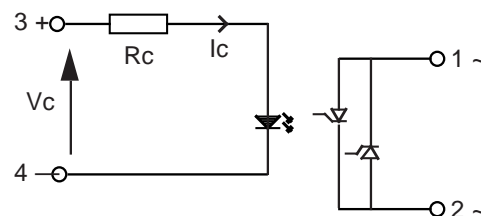

Figure 3 — LS relays

INPUT (CONTROL) SPECIFICATION

	Min	Max	Units
Control Range	4	14	Vdc
Input Current Range	6.5	30	mAdc
Must Turn-off Voltage		1	Vdc
Input Resistance (Typical)		440	Ohms

OUTPUT (LOAD) SPECIFICATION

	Min	Max	Unit
Operating Range			
LS24	12	280	Vrms
LS60	24	600	Vrms

Peak Voltage

LS24D16C	600	Vpeak
LS60D22C	1200	Vpeak

Load Current Range

LS24D16C	.005	16*	Arms
LS60D22C	.005	25*	Arms
LS24D27C	.005	30*	Arms
LS60D30C	.005	30*	Arms

*Limited by the heat sink

Maximum Surge Current Rating (Non-Repetitive)

(See Figure 6)

LS24D16C	160	Apeak
LS60D22C	300	Apeak
LS24D27C	600	Apeak
LS60D30C	1000	Apeak

On-State Voltage Drop	1.6	V
-----------------------	-----	---

Zero-Cross Window (Typical)	±12	V
-----------------------------	-----	---

Off-State Leakage Current (60Hz)	1	mA
----------------------------------	---	----

CONTROL CHARACTERISTIC

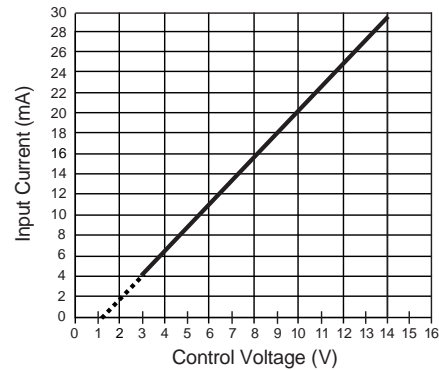

Figure 4 — LS relays

THERMAL CHARACTERISTICS

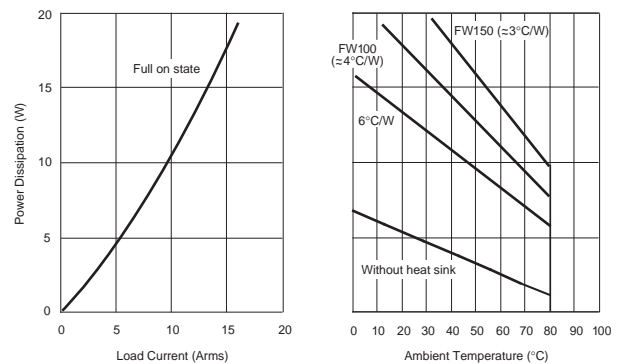

Figure 5a — LS24D16C relay

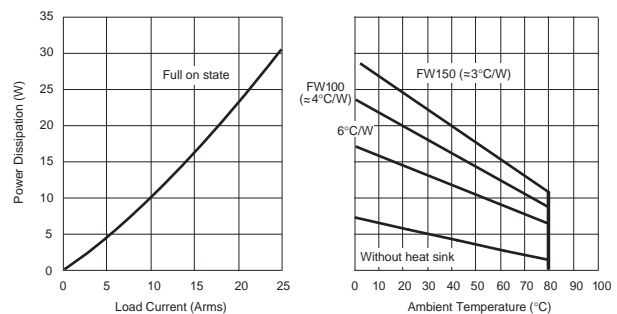

Figure 5b — LS60D22C relays

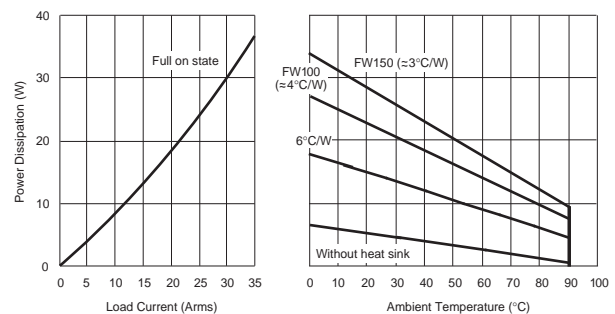

Figure 5c — LS24D27C, LS60D30C relays

OUTPUT (LOAD) SPECIFICATION (continued)

	Min	Max	Unit
Turn-On Time (60Hz)		8.3	ms
Turn-Off Time (60Hz)		8.3	ms
Off-State dv/dt		500	V/μs
Operating Frequency	10	440	Hz
I²t for match fusing (<8.3ms)			
LS24D16C		128	A ² S
LS60D22C		450	A ² S
LS24D27C		1800	A ² S
LS60D30C		5000	A ² S

ENVIRONMENTAL SPECIFICATION

	Min	Max	Unit
Operating Temperature	-40	80	°C
Storage Temperature	-40	120	°C
Input-Output Isolation	4000		Vrms
Output-Case Isolation	3300		Vrms

NOTES:

- MOV across the output recommended for non-resistive loads — minimum size: 14mm
- Maximum current based on size of the heat sink and the ambient temperature.
- For 800Hz applications, contact factory.
- For additional/custom options, contact factory.

SURGE CURRENTS

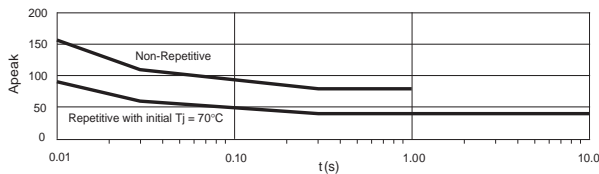

Figure 6a — LS24D16C relay

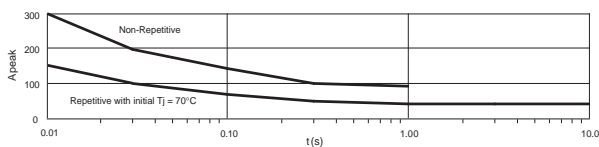

Figure 6c — LS60D22C relay

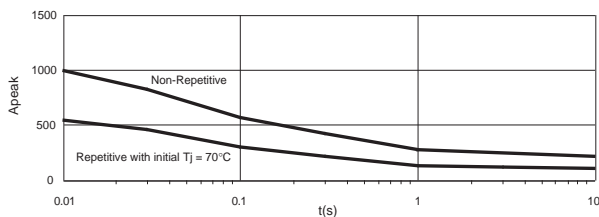
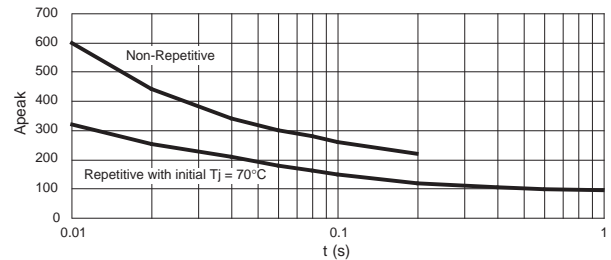

Figure 6e — LS60D30C relay



Long time overload @ Tj init = 45°C	Temps	60 s	100 s
	I (A)	20	15

Figure 6d — LS24D27C relays

MOUNTING EXAMPLES

Heat sinks references:

FW100: L=100mm about 4°C/W (1SSR) without ventilation (3.6°C/W with 4SSRs)

FW150: L=150mm about 3°C/W (1SSR) without ventilation (2.6°C/W with 6SSRs)

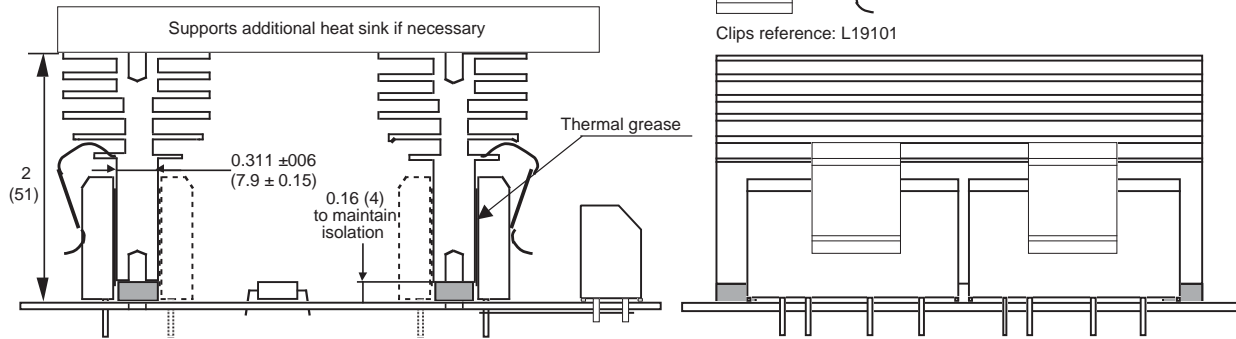

Figure 7a — Thermal heat sinks with mounting clips; dimensions in inches (mm)

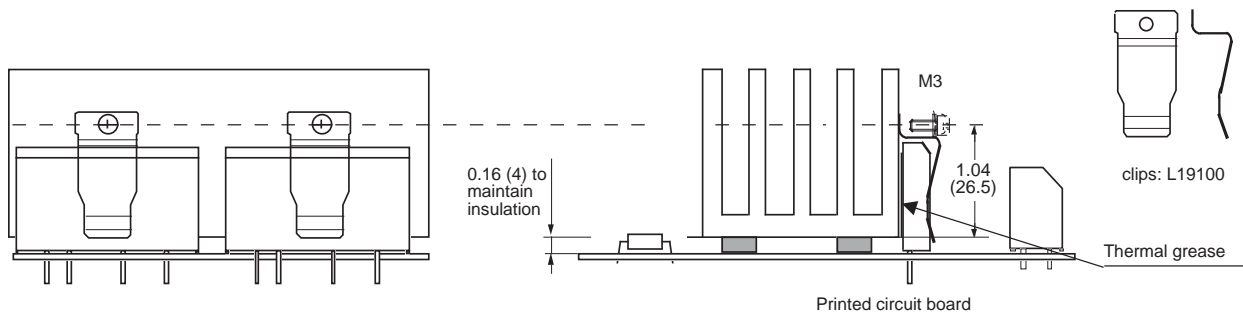

Figure 7b — Clips with screws on standard heat sinks; dimensions in inches (mm)

In each case, allow 0.16 in. (4mm) between the printed circuit board and the heat sink to keep a correct insulation between input to output (0.16 in./4mm insulated washer). To maintain a good contact between the SSR and the heat sink, use thermal grease.

MECHANICAL SPECIFICATION

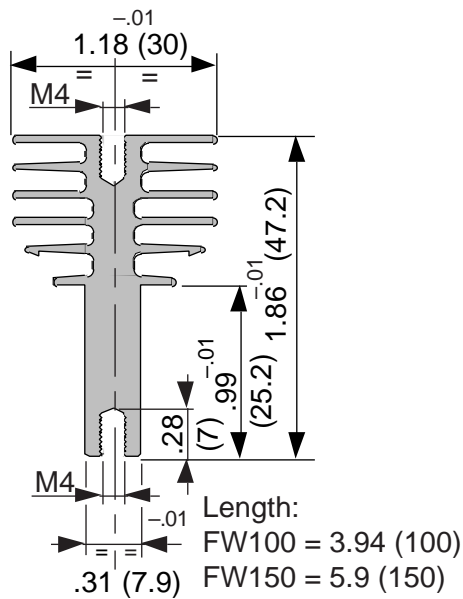

Figure 8 – FW100 and FW150 heat sinks; dimensions in inches (mm)

FW100 heat sink with Max Clip System*

Rth = 3.6°C/W (4 SSRs)

Rth = 4°C/W (1 SSR)

FW150 heat sink with Max Clip System*

Rth = 2.6°C/W (4 SSRs)

Rth = 3°C/W (1 SSR)

*The Max Clip System of Aavid Thermalloy, patented worldwide

L19101 CLIP

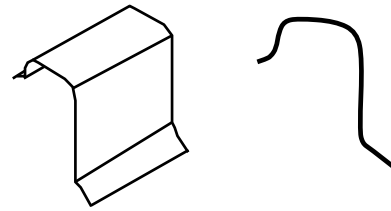

Figure 9a – Clip for FW100 and FW150 heat sinks

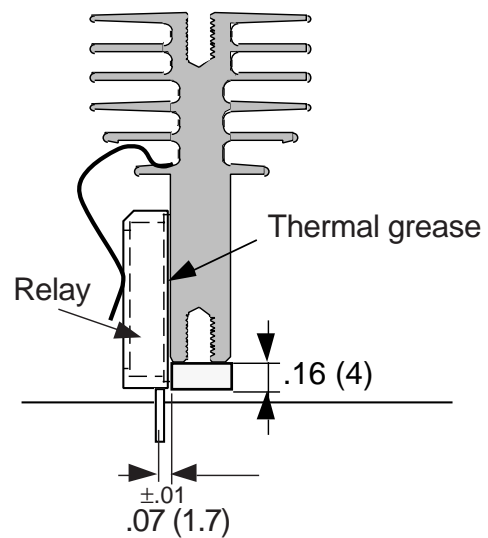

Figure 9b – Mounting with L19101 clip; dimensions in inches (mm)

L19100 CLIP

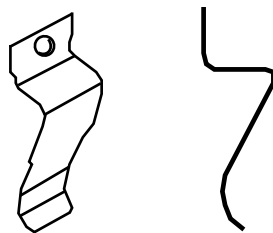

Figure 10a – Clips with screws for other heat sinks

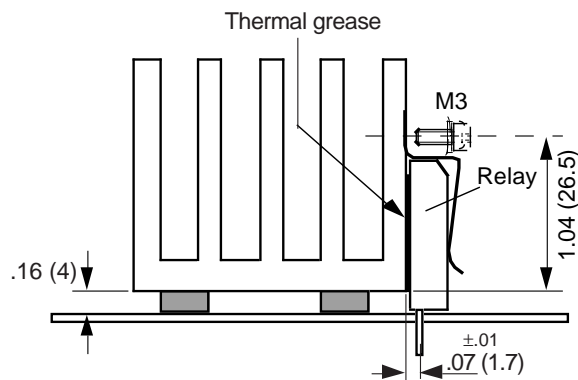

Figure 10b – Mounting with L19100 clip; dimensions in inches (mm)

NOTES

1. 0.16-inch (4mm) mounting washer must have correct insulation between input to output.

LS WITH HS1 HEAT SINK



Figure 11 – LS with HS1

INPUT (CONTROL) SPECIFICATION

	Min	Max	Units
Control Range			
LS24D16C-HS1	4	14	Vdc
Input Current Range			
LS24D16C-HS1	6.5	30	mAdc
Must Turn-Off Voltage			
All relays		1	Vdc
Input Resistance (Typical)			
LS24D16C-HS1		440	Ohms

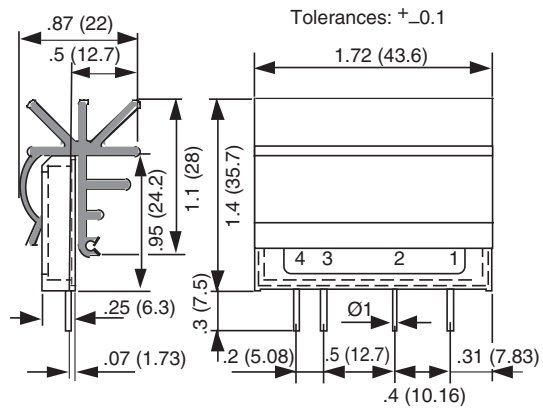

WEIGHT:
1.06 oz. (30g)

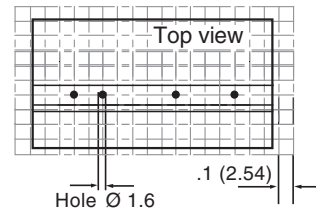

Figure 12 — LS relays with HS1;
dimensions in inches (mm)

LOAD CURRENT DERATING CURVE

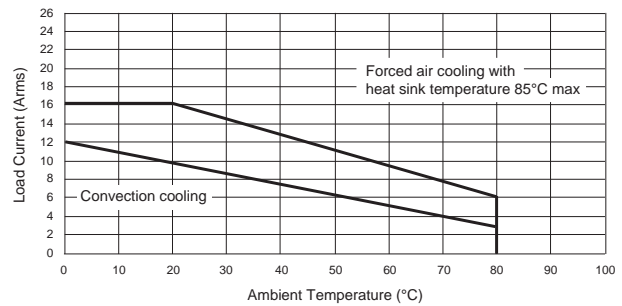

Figure 13a — LS24D16X-HS1 relays