

As a global company, we offer our products and support worldwide.

The LR Series conforms to international standards. The PATLITE group has built a global sales network to effectively provide goods and services to customers anywhere.

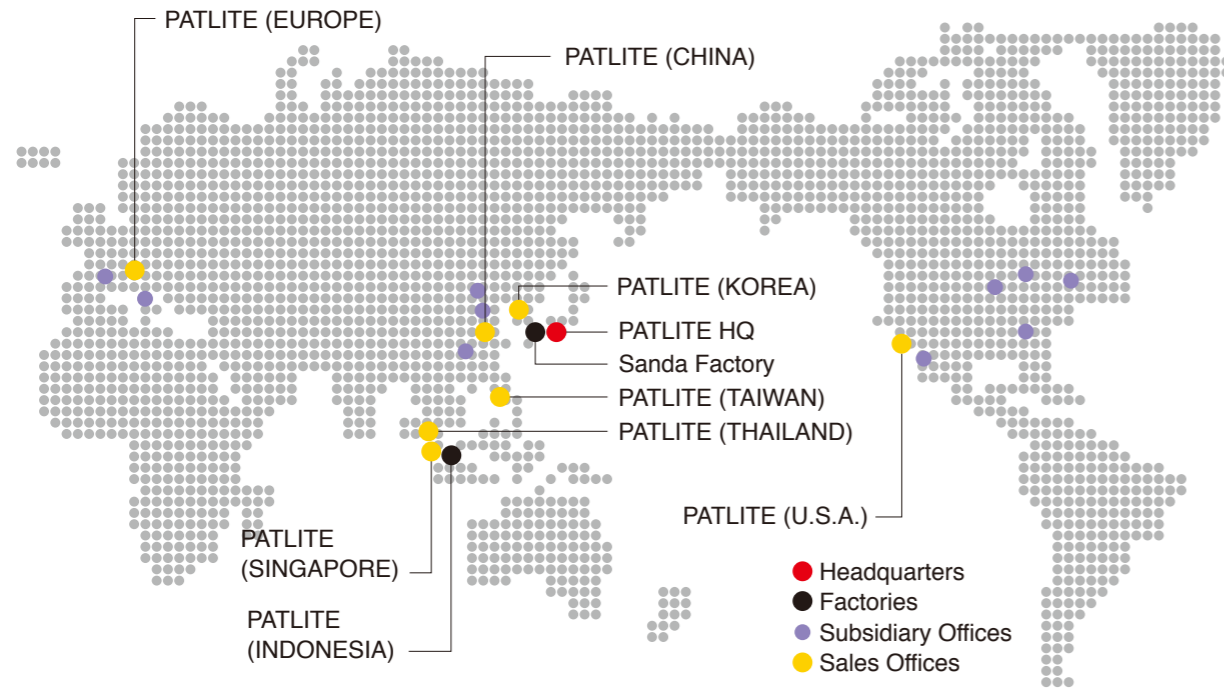

PATLITE Corporation

4-1-3, Kyutaromachi, Chuo-ku, Osaka 541-0056 Japan
TEL. +81-6-7711-8953 FAX: +81-6-7711-8961 E-mail: overseas@patlite.co.jp

PATLITE (U.S.A.) Corporation

20130 S. Western Ave. Torrance, CA 90501, U.S.A.
TEL. +1-310-328-3222 FAX: +1-310-328-2676 E-mail: sales@patlite.com

PATLITE (SINGAPORE) PTE LTD

No.2 Leng Kee Road, #05-01 Thye Hong Centre, Singapore 159086
TEL. +65-6226-1111 FAX: +65-6324-1411 E-mail: sales@patlite.com.sg

PATLITE (CHINA) Corporation

Room 1102-1103, No.55, Lane 777, Guangzhong Road (West), Zhabei District, Shanghai, China 200072
TEL. +86-21-6630-8969 FAX: +86-21-6630-8938 E-mail: sales@patlite.cn

PATLITE Europe GmbH

Am Soeldnermoos 8, D-85399 Hallbergmoos, Germany
TEL. +49-811-9981-9770-0 FAX: +49-811-9981-9770-9 E-mail: info@patlite.eu

PATLITE KOREA CO., LTD.

A2603, Daesung, D-POLIS, 606, Seobusaet-gil, Geumcheon-gu, Seoul, 08504, Korea
TEL. +82-2-523-6636 FAX: +82-2-861-9919 E-mail: sales@patlite.co.kr

PATLITE TAIWAN CO., LTD.

7F. No. 91, Huayin St, Datong District Taipei, Taiwan R.O.C
TEL. +886-2-2555-1611 FAX: +886-2-2555-1621 E-mail: info@patlite.tw

PATLITE (THAILAND) CO., LTD.

Olympia Thai Tower, 15th Floor 444 Ratchadapisek Road Samsennok, Huay Kwang Bangkok 10310, Thailand
TEL. +66-2-541-5431 FAX: +66-2-541-5429 E-mail: sales@patlite.co.th

CAUTION

To ensure correct use of these products, read the "Instruction Manual" prior to use. Failure to follow all safeguards can result in fire, electric shock, or other accidents. Specifications are subject to change without notice.

PATLITE ECO PROJECT

For the benefit of mankind and the earth, Patlite is committed to developing environmentally friendly products.

0-AF08A EN 1610 A

PATLITE®
New Frontiers in Safety, Security and Comfort.

Signal Tower
LR Series



NEMA Type 4X, 13 360° Buzzer Easy-build

<http://www.patlite.com>

●PATLITE, the PATLITE logo are either registered trademarks or trademarks of PATLITE Corporation in JAPAN and/or other countries.

www.patlite.com

**2 year
Warranty**

Signal Tower

LR Series

Modular LED Signal Tower

- φ40mm
LR4
- φ50mm
LR5
- φ60mm
LR6
- φ70mm
LR7



Modular Components

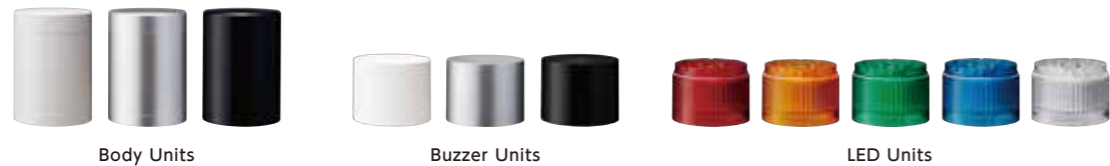

Optional Parts

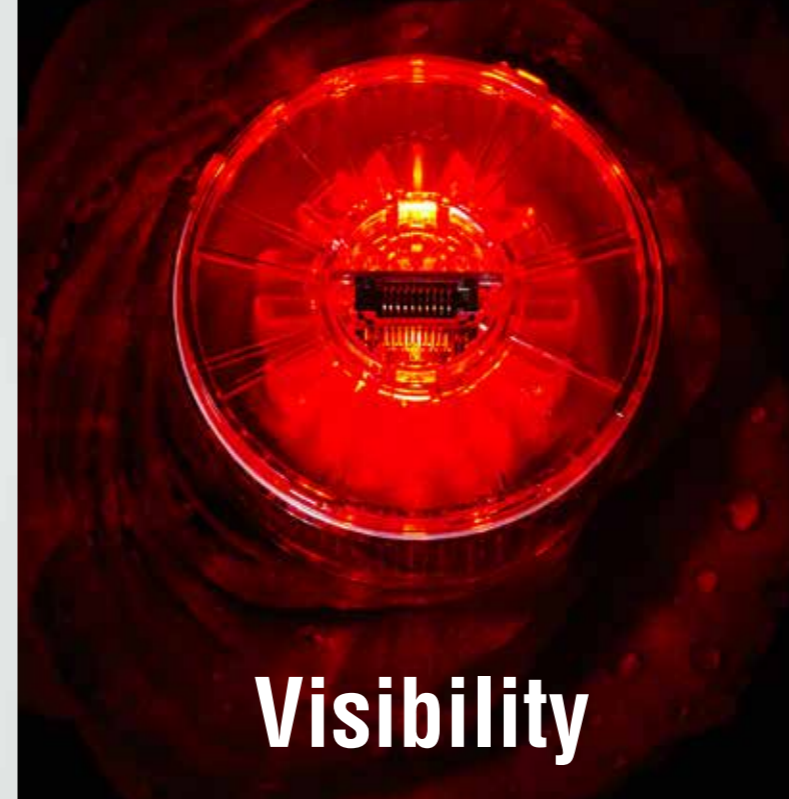

Visibility

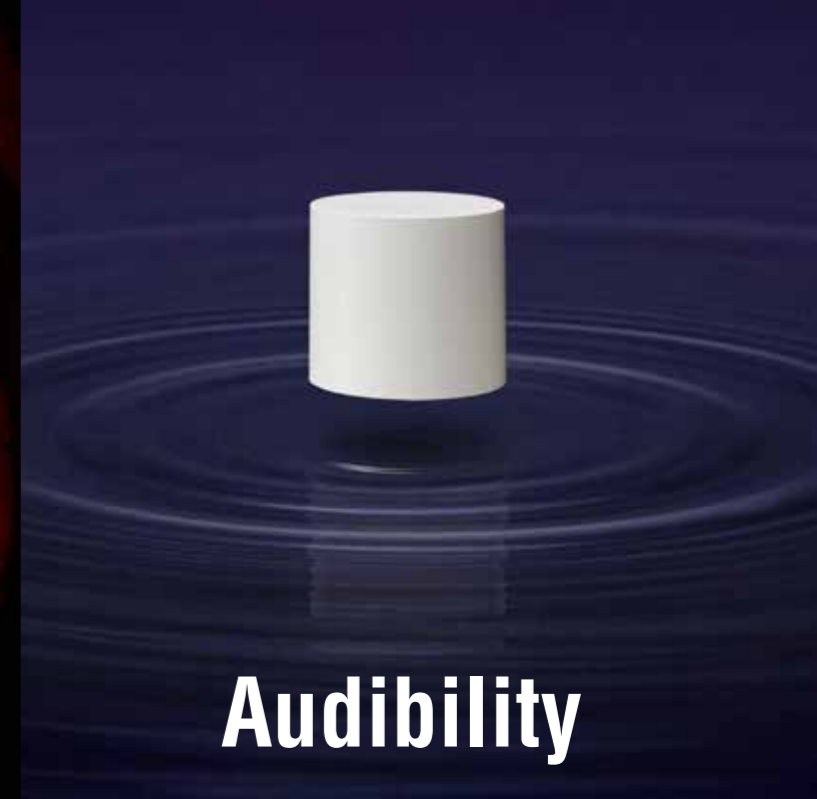

Audibility



Simplicity



Durability

Index

LR Series Line up	-----	p.1
Index	-----	p.2
Features	-----	p.3-6
LR Series Pre-assembled Models	-----	p.7-10
LR Series Optional Parts	-----	p.11-12
LR Series Modular Models	-----	p.13-14
LR Series Upcoming Products	-----	p.15
Outer Dimensional Drawing	-----	p.16
Wiring Diagrams	-----	p.17
Specifications	-----	p.18

Configurator

Scan the QR code to build an LR model



http://www.patlite.com/LR_config/

Visibility

Exceptional Light Brilliance

With a new re-designed lens and improved light module construction, the LR series provides a brilliant, even light for visibility at further distances.



A uniform 360° Light-Emitting Design

The new LED color module features a new, unique interior lens construction that achieves a fuller, more uniform 360° degree light output. Light color is vibrant with more emission area for reliable indication from further distances.

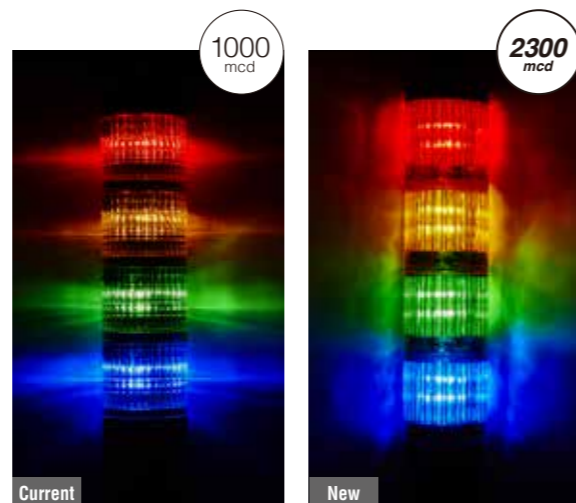

Current LCE-A Series (φ40) New LR4 Series (φ40)

More than Twice the Light Output*

The LR Series lens distributes light more efficiently, increasing luminous intensity by more than double that of our current models.

* Based on the φ40 Red LED Model

Audibility

No Holes, No Compromises

A re-engineered, completely enclosed sound module maintains substantial water and dust protection while producing loud, omnidirectional sound.

The Industry's First Fully Enclosed Sound Module

Inspired by a drum percussion instrument, the fully enclosed sound module is able to more efficiently vibrate sound waves, producing even 360° degree omnidirectional sound resonance. Resistance to water and dust is also increased.

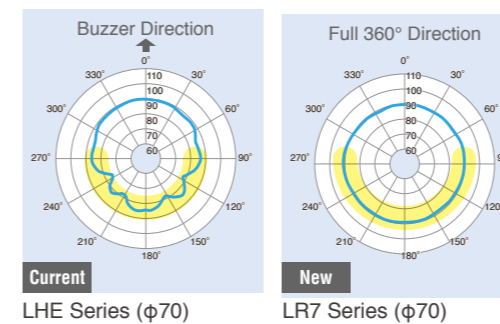

Maximum 90dB* output

The fully enclosed sound module structure produces more efficient sound, up to 90dB, at 1 meter.

*LR7 buzzer No.4 (Sweep tone)



360°
Sound

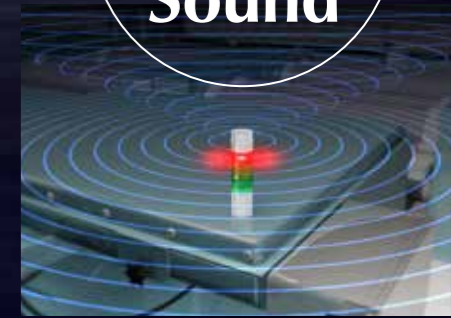

IP65 (IEC 60524) / NEMA TYPE 4X,13

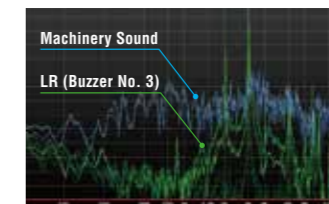

(Buzzer No.3) Rapid Hi-low Sound
2016Hz/3012Hz

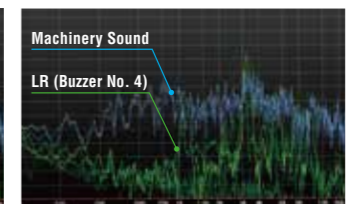

(Buzzer No.4) Sweep Sound
1000Hz - 4032Hz (changing)

New Sounds Heard Above the Noise

Four buzzer sounds* are built in. The two new buzzer sounds are designed at a higher variable frequency to be heard above the noise of surrounding machinery. Alternatively, a sound reduction function of approx. -10dB is included to suit the environment.

* Four Buzzer Sounds

- No.1 Rapid Intermittent sound
- No.2 Continuous sound
- No.3 Rapid Hi-low
- No.4 Sweep sound



Simplicity

Convenient Modular Assembly

Simple "Twist and Lock" system makes it easy to customize and reconfigure light and sound modules.

Durability

Rugged Never Looked Better

A sleek, smooth form factor and an enhanced body construction, makes the LR well-suited for harsher environments.



Modular System Design

The modular LED unit system makes reorganizing the color configuration easy. Furthermore, if an LED light module ever becomes damaged, ordering and replacing modules are easier than ever.

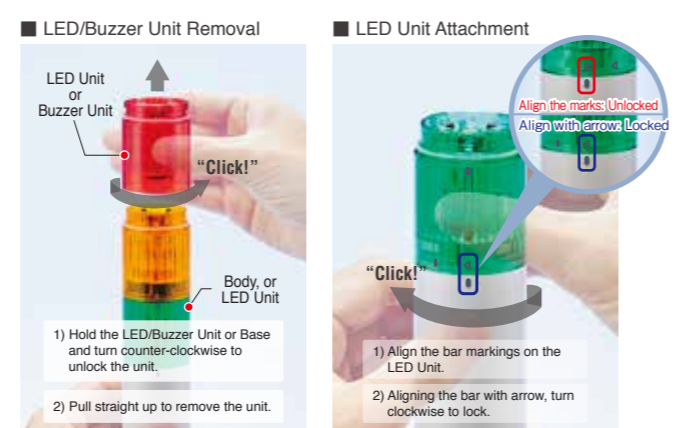

Reorganizing modules is effortless

Traditional stack lights typically require additional threaded shafts or tools to reconfigure light modules. With the LR Series, color reorganization, changing the number of light tiers and/or adding a sound module is easier than ever.



Smooth Surface

The LED light buzzer modules flushes together, creating a smooth surface for improved water run off and easy cleaning.



Environmental Performance

Built rugged with a water and dust resistant IP65 housing. IP65 (NEMA Type 4X, 13) withstands various environmental conditions, such as water and dust.



Upgraded Materials

All materials used were upgraded from previous models. Changing the base from ABS to Polycarbonate, and 'O' rings to silicone resin result in a more lightweight, shock resistant product.



Signal Tower

LR Series Pre-assembled Models

φ40mm Model Code

(Ex.) LR4-502WJBW-RYGBC

① Tiers	② Rated Voltage	③ Mounting/Wiring	④ Flashing/Buzzer	⑤ Body Color	⑥ LED Module Color
1 = 1 Tier	02 = DC24V	WJ = Direct/Cable	B = Flashing/Buzzer	W = Off-white	R = Red
2 = 2 Tiers	M2 = AC100 - 240V *1	LJ = Pole Mount w/L Bracket/Cable	N = No Flashing/Buzzer	U = Silver *3	Y = Amber
3 = 3 Tiers		PJ = Pole Mount w/Circular Bracket/Cable			G = Green
4 = 4 Tiers		QJ = Pole Mount w/Angle Bracket/Cable *2			B = Blue
5 = 5 Tiers					C = White

*1 For WJ and PJ type only *2 For DC24V and Off-white type only *3 For DC24V type WJ, LJ and PJ type only

φ50mm Model Code

(Ex.) LR5-502WJBW-RYGBC

① Tiers	② Rated Voltage	③ Mounting/Wiring	④ Flashing/Buzzer	⑤ Body Color	⑥ LED Module Color
1 = 1 Tier	01 = DC12V	WJ = Direct/Cable	B = Flashing/Buzzer	W = Off-white	R = Red
2 = 2 Tiers	02 = DC24V	LJ = Pole Mount w/L Bracket/Cable	N = No Flashing/Buzzer		Y = Amber
3 = 3 Tiers		PJ = Pole Mount w/Circular Bracket/Cable			G = Green
4 = 4 Tiers					B = Blue
5 = 5 Tiers					C = White

φ60mm Model Code

(Ex.) LR6-502WJBW-RYGBC

① Tiers	② Rated Voltage	③ Mounting/Wiring	④ Flashing/Buzzer	⑤ Body Color	⑥ LED Module Color
1 = 1 Tier	02 = DC24V	WJ = Direct/Cable	B = Flashing/Buzzer	W = Off-white	R = Red
2 = 2 Tiers	M2 = AC100 - 240V *1	LJ = Pole Mount w/L Bracket/Cable	N = No Flashing/Buzzer	U = Silver *2	Y = Amber
3 = 3 Tiers		PJ = Pole Mount w/Circular Bracket/Cable			G = Green
4 = 4 Tiers		QJ = Pole Mount w/Angle Bracket/Cable *2			B = Blue
5 = 5 Tiers					C = White

*1 For WJ and PJ type only *2 For DC24V and Off-white type only *3 For DC24V type WJ, LJ and PJ type only

φ70mm Model Code

(Ex.) LR7-502WJBW-RYGBC

① Tiers	② Rated Voltage	③ Mounting/Wiring	④ Flashing/Buzzer	⑤ Body Color	⑥ LED Module Color
1 = 1 Tier	02 = DC24V	WJ = Direct/Cable	B = Flashing/Buzzer	W = Off-white	R = Red
2 = 2 Tiers			N = No Flashing/Buzzer		Y = Amber
3 = 3 Tiers					G = Green
4 = 4 Tiers					B = Blue
5 = 5 Tiers					C = White

Mounting Type	Rated Voltage	Size	Flash/Buzzer	Tiers	Model	Power Consumption	Mass	
Direct Mount	DC12V	φ50	-	1	LR5-101WJNW	1.0W	0.240kg	
				2	LR5-201WJNW	2.0W	0.280kg	
				3	LR5-301WJNW	3.0W	0.320kg	
				4	LR5-401WJNW	4.0W	0.360kg	
				5	LR5-501WJNW	5.0W	0.400kg	
				O	1	LR5-101WJBW	2.1W	0.290kg
					2	LR5-201WJBW	3.1W	0.330kg
					3	LR5-301WJBW	4.1W	0.370kg
					4	LR5-401WJBW	5.1W	0.410kg
					5	LR5-501WJBW	6.1W	0.450kg
Direct Mount	DC24V	φ40	-		1	LR4-102WJNW/U	1.0W	0.205kg/0.355kg
					2	LR4-202WJNW/U	2.0W	0.240kg/0.390kg
					3	LR4-302WJNW/U	3.0W	0.275kg/0.425kg
					4	LR4-402WJNW/U	4.0W	0.310kg/0.460kg
					5	LR4-502WJNW/U	5.0W	0.345kg/0.495kg
				O	1	LR4-102WJBW/U	2.0W	0.240kg/0.390kg
					2	LR4-202WJBW/U	3.0W	0.275kg/0.425kg
					3	LR4-302WJBW/U	4.0W	0.310kg/0.460kg
					4	LR4-402WJBW/U	5.0W	0.345kg/0.495kg
					5	LR4-502WJBW/U	6.0W	0.380kg/0.530kg
Direct Mount	DC24V	φ50	-		1	LR5-102WJNW	1.0W	0.240kg
					2	LR5-202WJNW	2.0W	0.280kg
					3	LR5-302WJNW	3.0W	0.320kg
					4	LR5-402WJNW	4.0W	0.360kg
					5	LR5-502WJNW	5.0W	0.400kg
				O	1	LR5-102WJBW	2.0W	0.290kg
					2	LR5-202WJBW	3.0W	0.330kg
					3	LR5-302WJBW	4.0W	0.370kg
					4	LR5-402WJBW	5.0W	0.410kg
					5	LR5-502WJBW	6.0W	0.450kg
Direct Mount	DC24V	φ60	-		1	LR6-102WJNW/U	1.0W	0.280kg/0.410kg
					2	LR6-202WJNW/U	2.0W	0.340kg/0.470kg
					3	LR6-302WJNW/U	3.0W	0.400kg/0.530kg
					4	LR6-402WJNW/U	4.0W	0.460kg/0.590kg
					5	LR6-502WJNW/U	5.0W	0.520kg/0.650kg
				O	1	LR6-102WJBW/U	2.0W	0.340kg/0.470kg
					2	LR6-202WJBW/U	3.0W	0.400kg/0.530kg
					3	LR6-302WJBW/U	4.0W	0.460kg/0.590kg
					4	LR6-402WJBW/U	5.0W	0.520kg/0.650kg
					5	LR6-502WJBW/U	6.0W	0.580kg/0.710kg
Direct Mount	DC24V	φ70	-		1	LR7-102WJNW	1.0W	0.305kg
					2	LR7-202WJNW	2.0W	0.370kg
					3	LR7-302WJNW	3.0W	0.435kg
					4	LR7-402WJNW	4.0W	0.500kg
					5	LR7-502WJNW	5.0W	0.565kg
				O	1	LR7-102WJBW	2.0W	0.375kg
					2	LR7-202WJBW	3.0W	0.440kg
					3	LR7-302WJBW	4.0W	0.505kg
					4	LR7-402WJBW	5.0W	0.570kg
					5	LR7-502WJBW	6.0W	0.635kg
Pole Mount w/ Angle Bracket	DC24V	φ40	-		1	LR4-102QJNW	1.0W	0.455kg
					2	LR4-202QJNW	2.0W	0.490kg
					3	LR4-302QJNW	3.0W	0.525kg
					4	LR4-402QJNW	4.0W	0.560kg
					5	LR4-502QJNW	5.0W	0.595kg
		O	1	LR4-102QJBW	2.0W	0.490kg		
			2	LR4-202QJBW	3.0W	0.525kg		
			3	LR4-302QJBW	4.0W	0.560kg		
			4	LR4-402QJBW	5.0W	0.595kg		
			5	LR4-502QJBW	6.0W	0.630kg		
		φ60	-	1	LR6-102QJNW	1.0W	0.520kg	
				2	LR6-202QJNW	2.0W	0.580kg	
				3	LR6-302QJNW	3.0W	0.640kg	
				4	LR6-402QJNW	4.0W	0.700kg	
				5	LR6-502QJNW	5.0W	0.760kg	
O	1	LR6-102QJBW	2.0W	0.580kg				
	2	LR6-202QJBW	3.0W	0.640kg				
	3	LR6-302QJBW	4.0W	0.700kg				
	4	LR6-402QJBW	5.0W	0.760kg				
	5	LR6-502QJBW	6.0W	0.820kg				
Pole Mount w/ Angle Bracket	AC100 - 240V	φ40	-	1	LR4-1M2WJNW	1.5W	0.285kg	
				2	LR4-2M2WJNW	3.0W	0.320kg	
				3	LR4-3M2WJNW	4.5W	0.355kg	
				4	LR4-4M2WJNW	6.0W	0.390kg	
				5	LR4-5M2WJNW	7.5W	0.425kg	
		O	1	LR4-1M2WJBW	3.0W	0.320kg		
			2	LR4-2M2WJBW	4.5W	0.355kg		
			3	LR4-3M2WJBW	6.0W	0.390kg		
			4	LR4-4M2WJBW	7.5W	0.425kg		
			5	LR4-5M2WJBW	9.0W	0.460kg		
		φ60	-	1	LR6-1M2WJNW	1.5W	0.380kg	
				2	LR6-2M2WJNW	3.0W	0.440kg	
				3	LR6-3M2WJNW	4.5W	0.500kg	
				4	LR6-4M2WJNW	6.0W	0.560kg	
				5	LR6-5M2WJNW	7.5W	0.620kg	
O	1	LR6-1M2WJBW	3.0W	0.440kg				
	2	LR6-2M2WJBW	4.5W	0.500kg				
	3	LR6-3M2WJBW	6.0W	0.560kg				
	4	LR6-4M2WJBW	7.5W	0.620kg				
	5	LR6-5M2WJBW	9.0W	0.680kg				

Signal Tower

LR Series Pre-assembled Models

Mounting Type	Rated Voltage	Size	Flash/Buzzer	Tiers	Model	Power Consumption	Mass
	DC12V	φ50	-	1	LR5-101PJNW	1.0W	0.420kg
				2	LR5-201PJNW	2.0W	0.460kg
				3	LR5-301PJNW	3.0W	0.500kg
				4	LR5-401PJNW	4.0W	0.540kg
				5	LR5-501PJNW	5.0W	0.580kg
			O	1	LR5-101PJBW	2.1W	0.470kg
				2	LR5-201PJBW	3.1W	0.510kg
				3	LR5-301PJBW	4.4W	0.550kg
				4	LR5-401PJBW	5.1W	0.590kg
				5	LR5-501PJBW	6.1W	0.630kg
	DC24V	φ40	-	1	LR4-102PJNW/U	1.0W	0.395kg/0.545kg
				2	LR4-202PJNW/U	2.0W	0.430kg/0.580kg
				3	LR4-302PJNW/U	3.0W	0.465kg/0.615kg
				4	LR4-402PJNW/U	4.0W	0.500kg/0.650kg
				5	LR4-502PJNW/U	5.0W	0.535kg/0.685kg
			O	1	LR4-102PJBW/U	2.0W	0.430kg/0.580kg
				2	LR4-202PJBW/U	3.0W	0.465kg/0.615kg
				3	LR4-302PJBW/U	4.0W	0.500kg/0.650kg
				4	LR4-402PJBW/U	5.0W	0.535kg/0.685kg
				5	LR4-502PJBW/U	6.0W	0.570kg/0.720kg
φ50		-	1	LR5-102PJNW	1.0W	0.420kg	
			2	LR5-202PJNW	2.0W	0.460kg	
			3	LR5-302PJNW	3.0W	0.500kg	
			4	LR5-402PJNW	4.0W	0.540kg	
			5	LR5-502PJNW	5.0W	0.580kg	
		O	1	LR5-102PJBW	2.0W	0.470kg	
			2	LR5-202PJBW	3.0W	0.510kg	
			3	LR5-302PJBW	4.0W	0.550kg	
			4	LR5-402PJBW	5.0W	0.590kg	
			5	LR5-502PJBW	6.0W	0.630kg	
φ60	-	1	LR6-102PJNW/U	1.0W	0.460kg/0.590kg		
		2	LR6-202PJNW/U	2.0W	0.520kg/0.650kg		
		3	LR6-302PJNW/U	3.0W	0.580kg/0.710kg		
		4	LR6-402PJNW/U	4.0W	0.640kg/0.770kg		
		5	LR6-502PJNW/U	5.0W	0.700kg/0.830kg		
	O	1	LR6-102PJBW/U	2.0W	0.520kg/0.650kg		
		2	LR6-202PJBW/U	3.0W	0.580kg/0.710kg		
		3	LR6-302PJBW/U	4.0W	0.640kg/0.770kg		
		4	LR6-402PJBW/U	5.0W	0.700kg/0.830kg		
		5	LR6-502PJBW/U	6.0W	0.760kg/0.890kg		
AC100 - 240V	φ40	-	1	LR4-1M2PJNW	1.5W	0.475kg	
			2	LR4-2M2PJNW	3.0W	0.510kg	
			3	LR4-3M2PJNW	4.5W	0.545kg	
			4	LR4-4M2PJNW	6.0W	0.580kg	
			5	LR4-5M2PJNW	7.5W	0.615kg	
	O	1	LR4-1M2PJBW	3.0W	0.510kg		
		2	LR4-2M2PJBW	4.5W	0.545kg		
		3	LR4-3M2PJBW	6.0W	0.580kg		
		4	LR4-4M2PJBW	7.5W	0.615kg		
		5	LR4-5M2PJBW	9.0W	0.650kg		
φ60	-	1	LR6-1M2PJNW	1.5W	0.560kg		
		2	LR6-2M2PJNW	3.0W	0.620kg		
		3	LR6-3M2PJNW	4.5W	0.680kg		
		4	LR6-4M2PJNW	6.0W	0.740kg		
		5	LR6-5M2PJNW	7.5W	0.800kg		
O	1	LR6-1M2PJBW	3.0W	0.620kg			
	2	LR6-2M2PJBW	4.5W	0.680kg			
	3	LR6-3M2PJBW	6.0W	0.740kg			
	4	LR6-4M2PJBW	7.5W	0.800kg			
	5	LR6-5M2PJBW	9.0W	0.860kg			
DC12V	φ50	-	1	LR5-101LJNW	1.0W	0.530kg	
			2	LR5-201LJNW	2.0W	0.570kg	
			3	LR5-301LJNW	3.0W	0.610kg	
			4	LR5-401LJNW	4.0W	0.650kg	
			5	LR5-501LJNW	5.0W	0.690kg	
		O	1	LR5-101LJBW	2.1W	0.580kg	
			2	LR5-201LJBW	3.1W	0.620kg	
			3	LR5-301LJBW	4.1W	0.660kg	
			4	LR5-401LJBW	5.1W	0.700kg	
			5	LR5-501LJBW	6.1W	0.740kg	

Mounting Type	Rated Voltage	Size	Flash/Buzzer	Tiers	Model	Power Consumption	Mass
	DC24V	φ40	-	1	LR4-102LJNW/U	1.0W	0.495kg/0.645kg
				2	LR4-202LJNW/U	2.0W	0.530kg/0.680kg
				3	LR4-302LJNW/U	3.0W	0.565kg/0.715kg
				4	LR4-402LJNW/U	4.0W	0.600kg/0.750kg
				5	LR4-502LJNW/U	5.0W	0.635kg/0.785kg
			O	1	LR4-102LJBW/U	2.0W	0.530kg/0.680kg
				2	LR4-202LJBW/U	3.0W	0.565kg/0.715kg
				3	LR4-302LJBW/U	4.0W	0.600kg/0.750kg
				4	LR4-402LJBW/U	5.0W	0.635kg/0.785kg
				5	LR4-502LJBW/U	6.0W	0.670kg/0.820kg
		φ50	-	1	LR5-102LJNW	1.0W	0.530kg
				2	LR5-202LJNW	2.0W	0.570kg
				3	LR5-302LJNW	3.0W	0.610kg
				4	LR5-402LJNW	4.0W	0.650kg
				5	LR5-502LJNW	5.0W	0.690kg
			O	1	LR5-102LJBW	2.0W	0.580kg
				2	LR5-202LJBW	3.0W	0.620kg
				3	LR5-302LJBW	4.0W	0.660kg
				4	LR5-402LJBW	5.0W	0.700kg
				5	LR5-502LJBW	6.0W	0.740kg
φ60	-	1	LR6-102LJNW/U	1.0W	0.560kg/0.700kg		
		2	LR6-202LJNW/U	2.0W	0.620kg/0.760kg		
		3	LR6-302LJNW/U	3.0W	0.680kg/0.820kg		
		4	LR6-402LJNW/U	4.0W	0.740kg/0.880kg		
		5	LR6-502LJNW/U	5.0W	0.800kg/0.940kg		
	O	1	LR6-102LJBW/U	2.0W	0.620kg/0.760kg		
		2	LR6-202LJBW/U	3.0W	0.680kg/0.820kg		
		3	LR6-302LJBW/U	4.0W	0.740kg/0.880kg		
		4	LR6-402LJBW/U	5.0W	0.800kg/0.940kg		
		5	LR6-502LJBW/U	6.0W	0.860kg/1.000kg		

LED Units * All LED units can be used with all voltage types. Only a maximum of 5 LED units is possible.

Size	Color	Model	Power Consumption	Mass
φ40	Red	LR4-E-R	1.0W	0.035kg
	Amber	LR4-E-Y	1.0W	0.035kg
	Green	LR4-E-G	1.0W	0.035kg
	Blue	LR4-E-B	1.0W	0.035kg
	White	LR4-E-C	1.0W	0.035kg
φ50	Red	LR5-E-R	1.0W	0.040kg
	Amber	LR5-E-Y	1.0W	0.040kg
	Green	LR5-E-G	1.0W	0.040kg
	Blue	LR5-E-B	1.0W	0.040kg
	White	LR5-E-C	1.0W	0.040kg
φ60	Red	LR6-E-R	1.0W	0.060kg
	Amber	LR6-E-Y	1.0W	0.060kg
	Green	LR6-E-G	1.0W	0.060kg
	Blue	LR6-E-B	1.0W	0.060kg
	White	LR6-E-C	1.0W	0.060kg
φ70	Red	LR7-E-R	1.0W	0.065kg
	Amber	LR7-E-Y	1.0W	0.065kg
	Green	LR7-E-G	1.0W	0.065kg
	Blue	LR7-E-B	1.0W	0.065kg
	White	LR7-E-C	1.0W	0.065kg

Buzzer Units * Buzzer unit can be used with all voltage types. Products ordered with no buzzer can be purchased at a later date.

Size	Model	Power Consumption	Mass
φ40	LR4-B□	1.0W	0.035kg
φ50	LR5-BW	1.0W	0.050kg
φ60	LR6-B□	1.0W	0.060kg
φ70	LR7-BW	1.0W	0.070kg

LED Unit Model Code

LR□-E-□

Model ① Globe Color ②

① Size
4 = φ40
5 = φ50
6 = φ60
7 = φ70

② Color
R = Red
Y = Amber
G = Green
B = Blue
C = White

Buzzer Unit Model Code

LR□-B□

Model ① Buzzer Unit ②

① Size
4 = φ40
5 = φ50
6 = φ60
7 = φ70

② Color
W = Off-white
U = Silver*1
*1 LR4 / LR6 only

Signal Tower

LR Series Optional Parts

Direct Mount Brackets

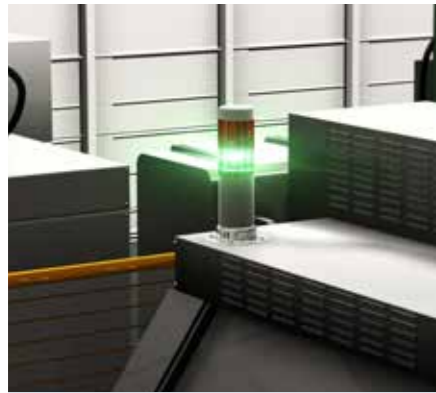

Circular Bracket
Model: SZW-001W

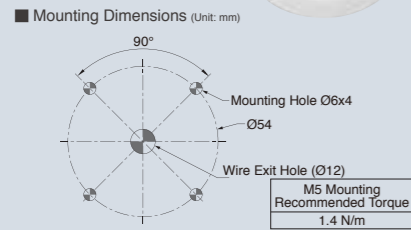

Wall-mount Bracket
Model: SZK-002W(U) SZK-003W(U)

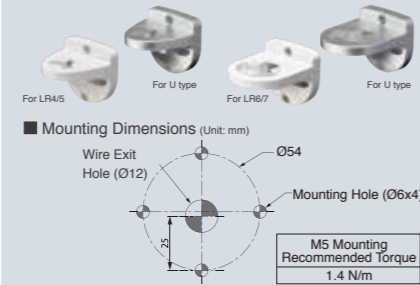

T Type Aluminum Pole Brackets

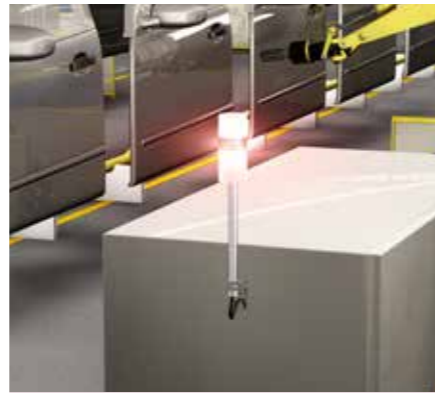

'L' Bracket
Model: SZL-001

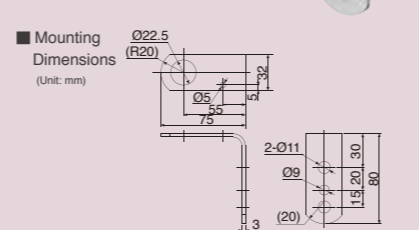

N Type Aluminum Pole Brackets

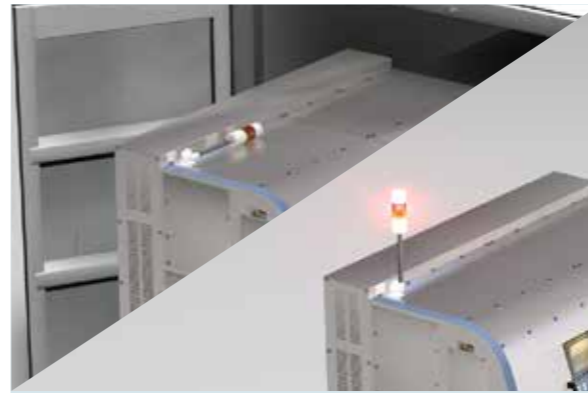

Angle Bracket
Model: SZQ-001W

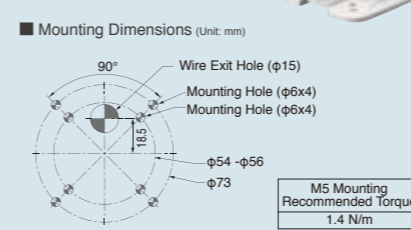

See the Movie!

- Depressing a locking lever on the left side of the angle bracket releases it to be lowered.
- Press the angle bracket forward and push about 15° in the clockwise direction. Pull forward and turn clockwise.
- The angle bracket is pushed down to the right (clockwise) until it locks in place with a "Click" sound.



Circular Bracket
Model: SZP-003W

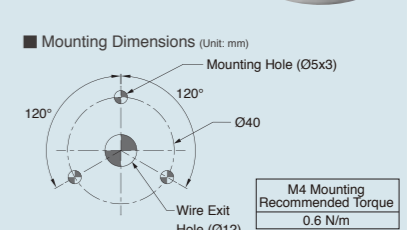

N Type Aluminum Pole Brackets

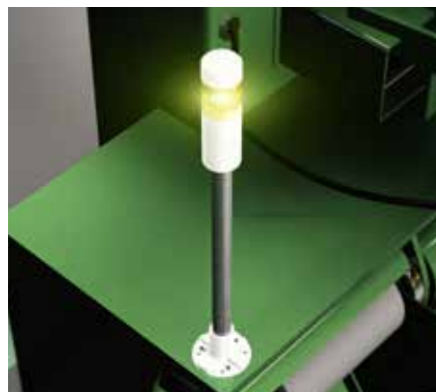

Circular Multi-pitch Bracket
Model: SZP-001W

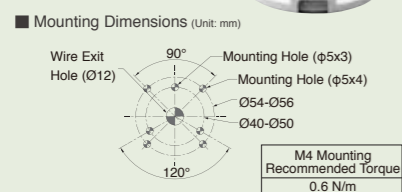

Wall-mount Bracket
Model: SZK-001U

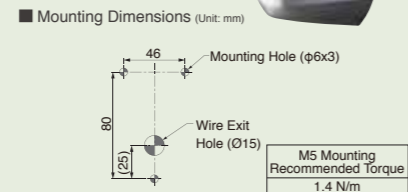

Circular Bracket
Model: SZP-002U

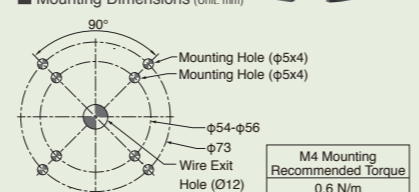

Aluminum Poles (Waterproof Ring/Screw Accessories included)

N Type			T Type		
100mm	300mm	800mm	300mm	500mm	1000mm
Model: POLE22-0100AN	Model: POLE22-0300AN	Model: POLE22-0800AN	Model: POLE22-0300AT	Model: POLE22-0500AT	Model: POLE22-1000AT

Replacement Parts

'O' ring/Headcover

'O' ring 40 Model: B25110065-F1	Headcover 40 Model: [W] B32310070-7F1 [U] B32310070-9F1	'O' ring 50 Model: B25110066-F1	Headcover 50 Model: [W] B32310071-7F1 [K] B32310071-8F1 [U] B32310071-9F1	'O' ring 60 Model: B25110067-F1	Headcover 60 Model: [W] B32310072-7F1 [U] B32310072-9F1	'O' ring 70 Model: B25110068-F1	Headcover 70 Model: [W] B32310073-7F1 [K] B32310073-8F1 [U] B32310073-9F1
------------------------------------	---------------------------------------------------------------	------------------------------------	------------------------------------------------------------------------------------	------------------------------------	---------------------------------------------------------------	------------------------------------	------------------------------------------------------------------------------------

Base Unit

Aluminum Pole Adaptor	LR4 Model: [W] B22210159-7F1 [U] B22210159-9F1	LR5 Model: [W] B22210160-7F1 [K] B22210160-8F1 [U] B22210160-9F1	LR6 Model: [W] B22210161-7F1 [U] B22210161-9F1
-----------------------	------------------------------------------------------	---------------------------------------------------------------------------	------------------------------------------------------

Terminal Block

Model: Z69544511-F1	
---------------------	--

Filter Sheet

	LR4 LED Unit Sheet Model: B25310067-4F1		LR5 LED Unit Sheet Model: B25310067-5F1		LR6 LED Unit Sheet Model: B25310067-6F1		LR7 LED Unit Sheet Model: B25310067-7F1
--	--------------------------------------------	--	--------------------------------------------	--	--------------------------------------------	--	--------------------------------------------

Signal Tower

LR Series Modular Models

Select a Buzzer Unit (for Flashing / Buzzer function)

Size	Color	Model	Power Consumption	Mass
φ40		LR4-B□	1.0W	0.035kg
φ50		LR5-B□	1.0W	0.050kg
φ60		LR6-B□	1.0W	0.060kg
φ70		LR7-B□	1.0W	0.070kg

□···W: Off-white U: Silver K: Black

Select an LED Unit

Size	Color	Model	Power Consumption	Mass
φ40		LR4-E-R/Y/G/B/C	1.0W	0.035kg
φ50		LR5-E-R/Y/G/B/C	1.0W	0.040kg
φ60		LR6-E-R/Y/G/B/C	1.0W	0.060kg
φ70		LR7-E-R/Y/G/B/C	1.0W	0.065kg

Select a Body Unit



Direct Mount Models (WJ, WT)

Power Supply	Mounting	Model	Size
DC24V	Cable	LR4	φ40
DC12V / DC24V	Cable / Terminal	LR5	φ50
DC24V / AC100-240V	Cable	LR6	φ60
DC24V	Cable / Terminal	LR7	φ70
Power Supply	Mounting	Model	Size
DC24V	Cable	LR4	φ40
DC12V / DC24V	Cable	LR5	φ50
DC24V	Cable	LR6	φ60

Circular Bracket Mount Models (PJ)

Power Supply	Mounting	Model	Size
DC24V / AC100-240V	Cable	LR4	φ40
DC12V / DC24V	Cable	LR5	φ50
DC24V / AC100-240V	Cable	LR6	φ60
Power Supply	Mounting	Model	Size
DC24V	Cable	LR4	φ40
DC24V	Cable	LR6	φ60

Angle Bracket Models (QJ)

Power Supply	Mounting	Model	Size
DC24V	Cable	LR4	φ40
DC24V	Cable	LR6	φ60

Color Units ordered outside the Standard Stock can be delivered in a short time.

Prompt Delivery

EASY Assembly

Body Unit Model Code

(Ex.) **LR6-02WJNW**

Model ① ② ③ ④ ⑤

- (1) Size: 4 = φ40, 5 = φ50, 6 = φ60, 7 = φ70
- (2) Rated Voltage: 01 = DC12V^{*1}, 02 = DC24V, M2 = AC100-240V^{*2}
- (3) Mounting/Wiring: WJ = Direct w/Cable, WT = Direct w/Terminal^{*3}, LJ = Pole/ 'L' Bracket w/Cable^{*4}, PJ = Pole/ Circular Bracket w/Cable^{*4}, QJ = Pole/ Angle Bracket w/Cable^{*5}
- (4) Flashing/Buzzer: N = No Flashing/Buzzer
- (5) Body Color: W = Off-white, U = Silver, K = Black^{*6}

^{*1} For LR5 models only
^{*2} For WJ and PJ mounting with LR4 and LR6 models
^{*3} For LR5, LR7 DC24V models only
^{*4} For LR4, LR5 and LR6 models
^{*5} With LR4 and LR6 DC24V Off-white models only
^{*6} For LR5, LR7 models only

3 Easy Steps

1 Remove the headcover to setup the body unit



2 Attach one LED unit at a time to the body unit



3 Replace the headcover, or attach the buzzer unit



See the Movie!!

Scan the QR code to see how easy LR is to configure.



Mounting Type	Rated Voltage	Size	Wiring	Model
Direct Mount	DC12V	φ50	Cable	LR5-01WJNW
		φ40		LR4-02WJNW/U
		φ50		LR5-02WJNW
	DC24V	φ60	Screwless Terminal	LR6-02WJNW/U
		φ70		LR7-02WJNW
		φ50		LR5-02WTNW/U/K
Pole Mount w/ Circular Bracket	AC100 - 240V	φ40	Cable	LR4-M2WJNW
		φ60		LR6-M2WJNW
		φ50		LR5-01PJNW
	DC24V	φ40	Cable	LR4-02PJNW/U
		φ50		LR5-02PJNW
		φ60		LR6-02PJNW/U
Pole Mount w/ 'L' Bracket	AC100 - 240V	φ40	Cable	LR4-M2PJNW
		φ60		LR6-M2PJNW
		φ50		LR5-01LJNW
	DC24V	φ40	Cable	LR4-02LJNW/U
		φ50		LR5-02LJNW
		φ60		LR6-02LJNW/U
Pole Mount w/ Angle Bracket	DC24V	φ40	Cable	LR4-02QJNW
		φ60		LR6-02QJNW

Removable Screwless Terminal



A new removable terminal For easier wiring.

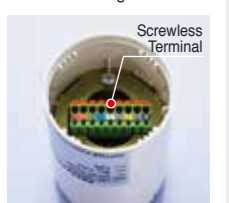

The terminal can be pulled out

LR Series Upcoming Products

LR Series 2nd Phase

Available in 2017

Clear Lens LED Unit LR4/LR6

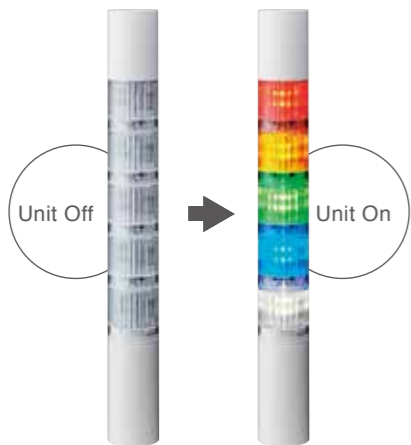

Multi-color LED Unit LR6



Accessories & Options

M12 Connector

LR6

NPT Adaptor

LR4-LR7

Wall Mount Bracket (Uncovered Cable)

LR6/LR7

Signal Tower with Switch Box

LR5

Wireless Data Acquisition System WD Series and LR Series

The WD Series is a system for retrieving data from PATLITE Signal Towers remotely and in real-time. The WD system can be used for a variety of applications, such as collecting data to identify production bottlenecks.



WD Series
PRO 2.4GHz WIRELESS SYSTEM



Outer Dimensional Drawing (Unit: mm)

Mount A [WJ] Direct Mount/Cable (01: DC12V / 02: DC24V)

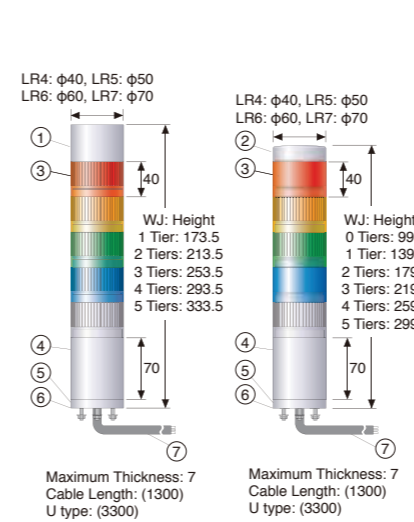

Mount A [WJ] Direct Mount/Cable (M2: AC100V - 240V)

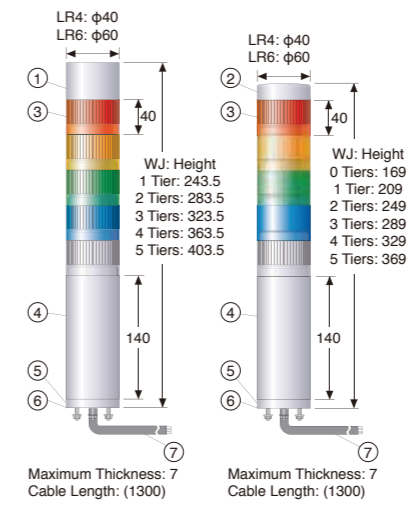

Mount A [WT] Direct Mount/ Screwless Terminal (Body Unit)

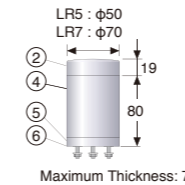

Number	Description	Material
①	Buzzer Assembly Unit	PC
②	Headcover	PC
③	LED Assembly Unit	Globe: PC
④	Body	PC
⑤	Direct-mount Bracket	PC
⑥	Waterproof Packing	Silicon Rubber
⑦	Cable	PVC

Mount B [LJ] Pole Mount w/'L' Bracket & Cable (02: DC24V)

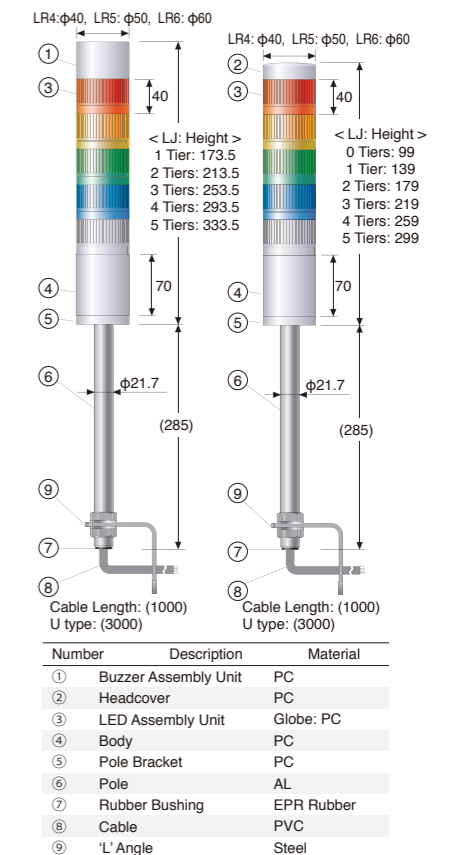

Mount A [PJ] Pole Mount w/Circular Bracket & Cable (01: DC12V / 02: DC24V)

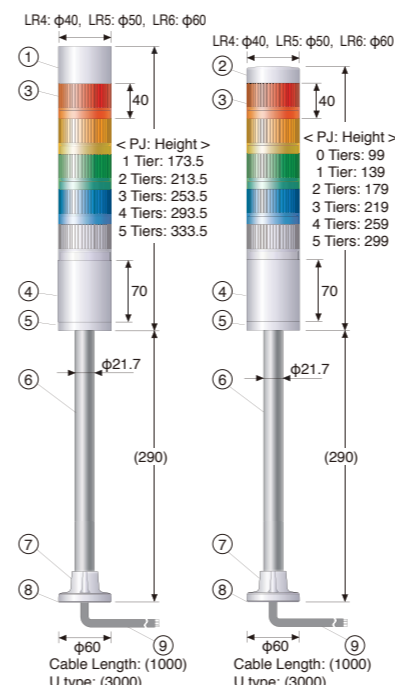

Number	Description	Material
①	Buzzer Assembly Unit	PC
②	Headcover	PC
③	LED Assembly Unit	Globe: PC
④	Body	PC
⑤	Pole Bracket	PC
⑥	Pole	AL
⑦	Circular Bracket	PC
⑧	Waterproof Packing	Silicon Rubber
⑨	Cable	PVC

Mount A [PJ] Pole Mount w/Circular Bracket & Cable (M2: AC100V - 240V)

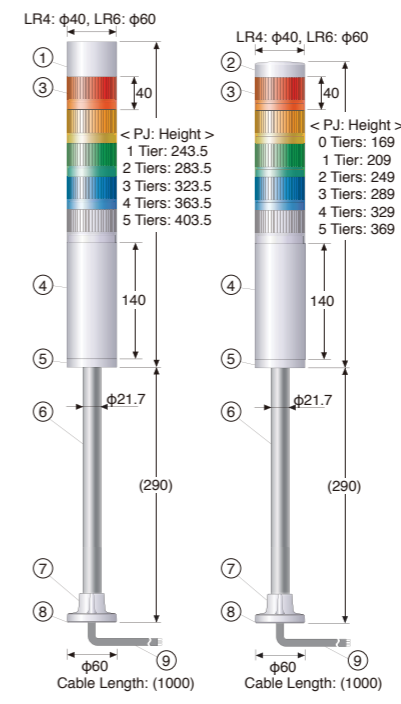

Number	Description	Material
①	Buzzer Assembly Unit	PC
②	Headcover	PC
③	LED Assembly Unit	Globe: PC
④	Body	PC
⑤	Pole Bracket	PC
⑥	Pole	AL
⑦	Circular Bracket	PC
⑧	Waterproof Packing	Silicon Rubber
⑨	Cable	PVC

Mount C [QJ] Pole Mount w/Angle Bracket & Cable (02: DC24V)

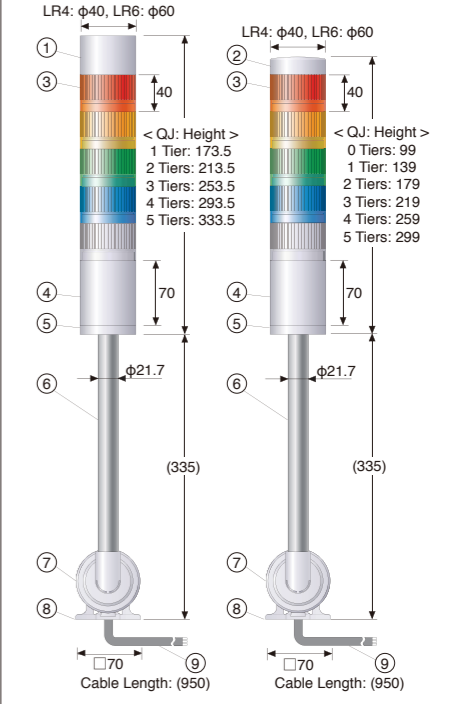

Number	Description	Material
①	Buzzer Assembly Unit	PC
②	Headcover	PC
③	LED Assembly Unit	Globe: PC
④	Body	PC
⑤	Pole Bracket	PC
⑥	Pole	AL
⑦	Angle Bracket	PC
⑧	Waterproof Packing	CR
⑨	Cable	PVC

Wiring Diagrams

Product Type [01] DC 12V [02] DC 24V
 Model LR □ - □ 02 □ / LR5 - □ 01 □ □ W

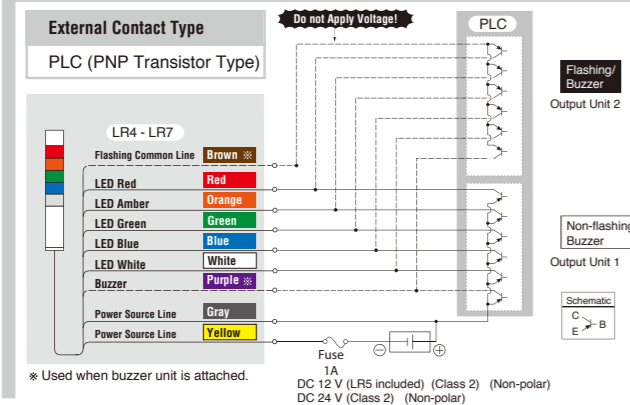
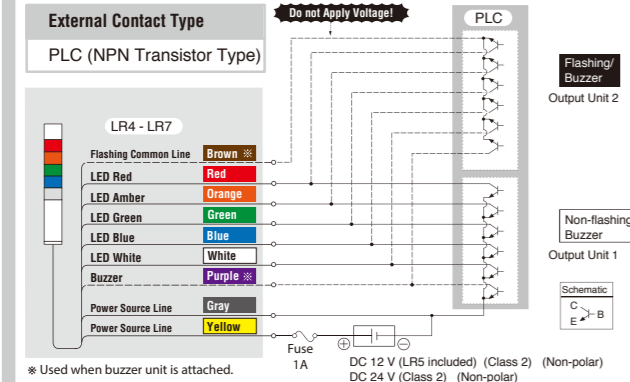
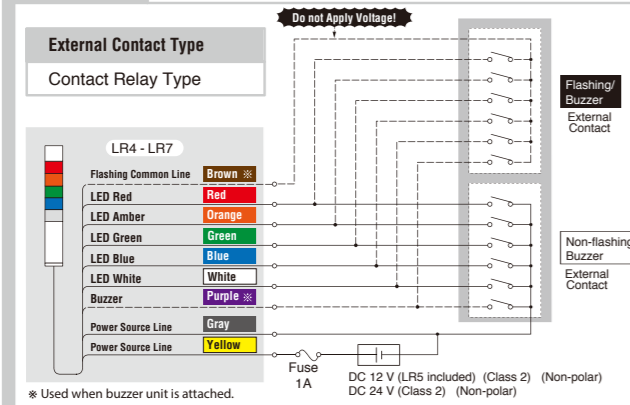

Product Type [M2] AC 100 - 240V
 Model LR □ - □ M2 □ □ W

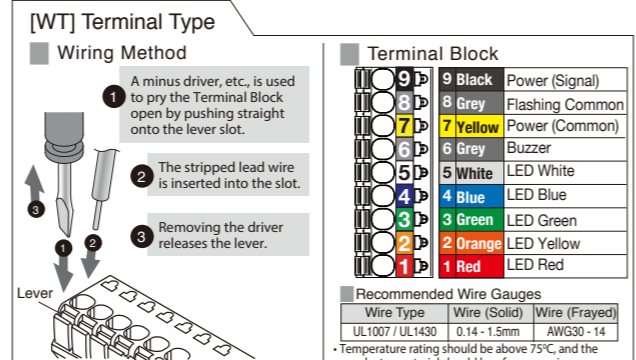
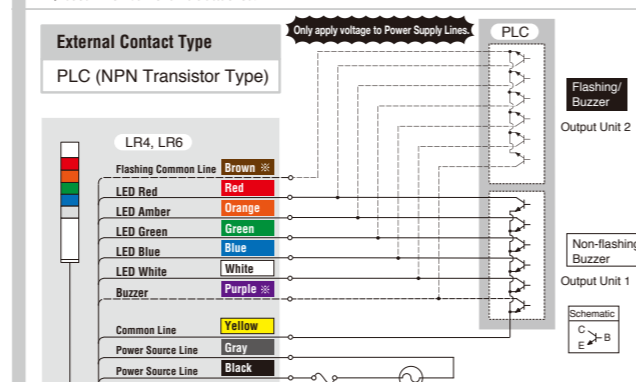
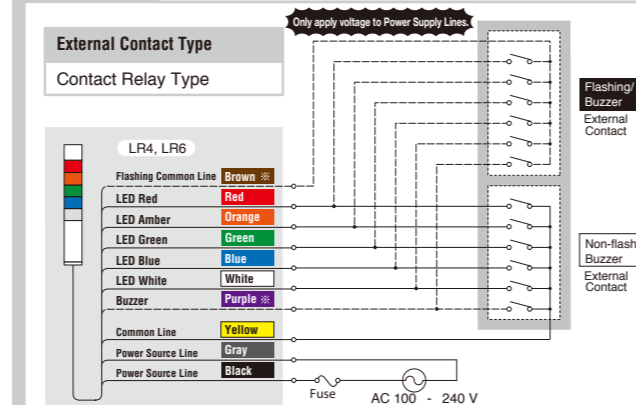

Mounting Dimensions (Unit: mm)

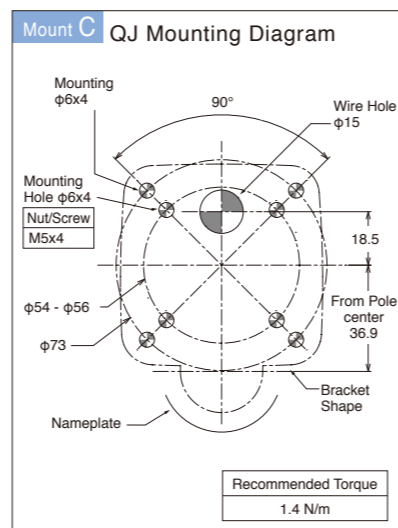
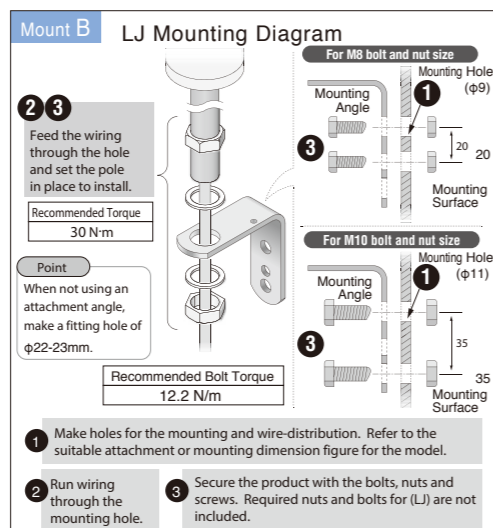
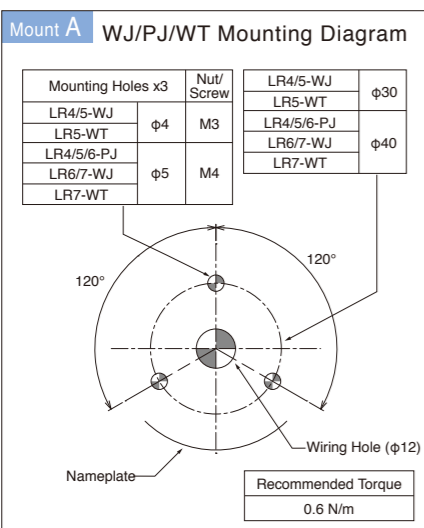

Specification

LR Series Fully-assembled Product General Specifications	
Operating Ambient Temperature	-20°C - +50°C
Operating Humidity Range	90% RH or less, no condensation
Storage Temperature Range	-30°C - +60°C
Storage Humidity Range	90% RH or less, no condensation
Mounting Location	Indoor Use
Mounting Direction	Upright Position
Protection Rating ^{*1}	IP65 (IEC 60529) / NEMA TYPE 4X, 13
Environmental Conditions	Upright Position
Insulation Resistance	More than 1MΩ at DC500V between the power input lead and chassis
Withstand Voltage	AC500V for 1 minute between terminals and chassis without breaking insulation (M2: AC1500V for 1 min.)
Flash Rate	60 ±2 flashes/ min
Sound Level	LR4 Typ. 85dB LR5 Typ. 85dB LR6 Typ. 88dB LR7 Typ. 90dB LR5 DC12V Typ. 80dB
Sound Reduction ^{*2}	ab. -10dB reduction
Environmental Conditions	Buzzer Sound No.4 (Sweep) from all directions at a 1m distance
Buzzer Sound	4 patterns ^{*2} No.1 Rapid Intermittent sound No.2 Continuous sound No.3 Rapid Hi-low No.4 Sweep sound
Transistor Output	NPN / PNP (AC100 - 240V is NPN only)
Conformity Standards	<ul style="list-style-type: none"> UL 508, CSA-C22.2 No.14 FCC Part 15 Subpart B Class A RoHS Directive (EN 50581) EMC Directive (EN 61000-6-4, EN 61000-6-2) KC (KN 61000-6-4, KN 61000-6-2) Low-voltage Directive (IEC/EN 60947-5-1, EN62471)^{*3}

*1: L Type is IP54 *2: Dependent on DIP Switch Settings *3: M2 Type Only

External Contact Capacity		Is:Current Capacity	Vs:Saturated Voltage	Il:Leakage Current	Ta:Ambient Temperature
Rated Voltage		DC12V ^{*1}	DC24V	AC100 - 240V ^{*2}	
LED Unit (Per Tier)	Signal Line Current	90mA	40mA	40mA	
	Contact Capacity	Is ≥ 100mA Vs ≥ DC35V	Is ≥ 100mA Vs ≥ DC35V	Is ≥ 100mA Vs ≥ DC35V	
Buzzer	Signal Line Current	90mA	40mA	40mA	
	Contact Capacity	Is ≥ 300mA Vs ≥ DC35V ^{*3}	Is ≥ 300mA Vs ≥ DC35V ^{*3}	Is ≥ 300mA Vs ≥ DC35V	
Power	Current Consumption	500mA	250mA	150mA	
	Contact Capacity	Is ≥ 700mA Vs ≥ DC35V	Is ≥ 700mA Vs ≥ DC35V	Current rating higher than inrush current	
Inrush Current	Signal Line	None ^{*3}	None ^{*3}	None	
	Power Line	0.7A at 15ms or less	0.7A at 0.5ms or less	25A (Ta=25°C), 50A (Ta=50°C) at 2.0ms or less	
Leakage Contact Current		Il ≤ 0.1 mA			

*1: LR5 Only *2: LR4/LR6 Only *3: An inrush current of 0.7A flows through the signal line when the Gray power source line is disconnected. Be sure to select an external contact which can withstand the capacity. [Recommended Fuse] Rated Current: 250V / 1A 5x20mm Fast-blow Glass Fuse

LED Unit General Specifications					
Color	Red	Amber	Green	Blue	White
Rated Voltage	DC24V				
Current Consumption/Power Consumption	Typ.	0.04A/1W	0.04A/1W	0.04A/1W	0.04A/1W
	Max.	0.045A/1.3W	0.045A/1.3W	0.045A/1.3W	0.045A/1.3W
Conformity Standards	<ul style="list-style-type: none"> UL 508, CSA-C22.2 No.14 EMC Directive (EN 61000-6-4, EN 61000-6-2) RoHS Directive (EN 50581) 				

Buzzer Unit General Specifications		
Rated Voltage	DC24V	
Current Consumption/Power Consumption	Typ.	0.04A/1W
	Max.	0.3A/1.3W
Standards/Conformity	<ul style="list-style-type: none"> UL 508, CSA-C22.2 No.14 EMC Directive (EN 61000-6-4, EN 61000-6-2) RoHS Directive (EN 50581) 	