

# LQW18AS15NJ0C#

"#" indicates a package specification code.



< List of part numbers with package codes >  
 LQW18AS15NJ0CD , LQW18AS15NJ0CJ , LQW18AS15NJ0CB

## Shape

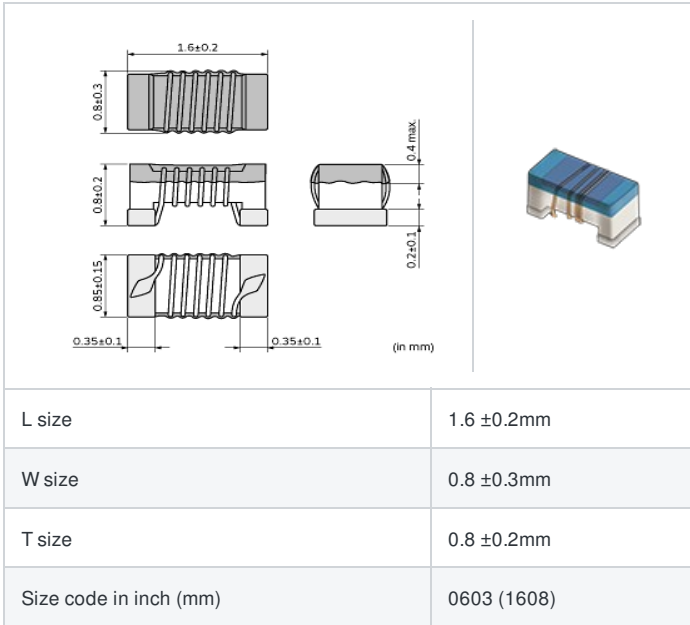

## References

Packaging code	Specifications	Minimum quantity
D	φ180mm Paper taping	4000
J	φ330mm Paper taping	10000
B	Packing in bulk	500

Mass (Typ.)	
1 piece	0.003g

## Specifications

Inductance	15nH ±5%
Inductance test frequency	250MHz
Rated current (Itemp) (Based on Temperature rise)	700mA
Max. of DC resistance	0.17Ω
Q (min.)	35
Q test frequency	250MHz
Self resonance frequency (min.)	4000MHz
Operating temperature range (Self-temperature rise is included)	-40°C to 85°C
Series	LQW18AS_0C

### Attention

- 1.This datasheet is downloaded from the website of Murata Manufacturing Co., Ltd. Therefore, it's specifications are subject to change or our products in it may be discontinued without advance notice. Please check with our sales representatives or product engineers before ordering.
- 2.This datasheet has only typical specifications because there is no space for detailed specifications. Therefore, please review our product specifications or consult the approval sheet for product specifications before ordering.