

Amphenol[®]



LPT Series Connectors

Amphenol

Table of Contents

● Company introduction	01
● Product introduction	02
● Market Applications	03
● Technical data	04
● How to order/Shell Type	05
● Crimp contact ordering info	06
● Machined contact ordering info	07
● Service class	08
● Alternate positioning	09
● Insert arrangements	10
● Product dimensions	12
● Assembly instructions	17



Amphenol Industrial Products Group

The Amphenol Industrial Products Group (AIPG), a group of the Amphenol Corporation, is a prominent manufacturer of cylindrical connectors known around the world. Amphenol Industrial's product lines consist of rectangular, standard miniature, fiber optic, EMI/EMP filter, and a variety of special application connectors.

Manufacturing connectors since 1932, we take pride that the Amphenol Industrial Products Group is the undisputed leader in interconnect systems for harsh environment applications. Innovations like our RADSOK® contact technology can provide roughly 50% more current through the same size pin. Connectors utilizing this RADSOK® technology will outperform similar products in the market hands down.

The Sidney, NY facility, nestled at the foothills of the Catskill Mountains, is over 307,000 square feet. This complex houses over 1,000+ employees incorporating state-of-the-art manufacturing technologies. The facility is both ISO9001 certified and qualified to MIL-STD-790 requirements.



Amphenol Technology (Zhuhai) Co., Ltd.

Established in 2007, Amphenol Technology (Zhuhai) Co., Ltd. is a manufacturing facility for the Amphenol Industrial Products Group, which serves a number of industrial markets, included but not limited to Factory Automation, Transportation, Heavy Equipment, Alternative Energy, Oil & Gas, Server/Data Comm and Power Distribution.

Amphenol Technology (Zhuhai) Co., Ltd. covers an area of 28,470m² and is equipped with CNCs, plating, injection molding and assembly workshops. This plant specializes in the design and manufacturing of industrial connectors featuring high power, high density inserts, medium to high voltage electrical properties, and harsh environment applications.

With industry leading engineering, design and manufacturing expertise, Amphenol Technology (Zhuhai) Co., Ltd. has earned more than 30 utility patents on its innovative interconnects. Many of the products produced have been certified by independent standards including UL, IEC/TUV, ATEX, IECEx and MA. The facility is also certified to ISO 9001, ISO 14001 and TS16949.

LPT Series Product Introduction



What are LPT Series Connectors?

The LPT Series is based on the MIL-C-26482 Series I and Amphenol's original PT Series. Cost effective without sacrificing quality. This series is a cylindrical bayonet connector constructed with an aluminum shell and features stamped and formed crimped contacts.

Features and Benefits

- Aluminum shell construction provides high strength while being light in weight
- Multiple shell plating options (up to 500H salt spray protection)
- Stamped and formed crimp contacts with a 3 tine retention system
- Machined contacts available
- Off the shelf availability
- Quick positive bayonet coupling
- 5 key/keyway mating
- Ingress protection up to IP67 and IP69K when in the mated condition
- High shock and high vibration resistance
- Operating temperature range: -40°C to 125°C
- Intermateable with Amphenol's PT series
- PT standard shells have years of proven performance in the field
- UL/TUV certifications in process

Structure Features

5 Shell Styles :

- ① Box mounting receptacle
- ② Jam nut receptacle
- ③ Straight plug
- ④ Wall mounting receptacle
- ⑤ Cable connecting receptacle

3 Connector Finishes Available:

- ① Black zinc (RoHS)
- ② Nickel (RoHS)
- ③ Gray zinc nickel(RoHS)

4 Alternate Positioning :

Insert rotation W,X,Y,Z

Crimp Contact Size :

- ① #12: 14-12 (2.00-4.00mm²)
- ② #16: 18-16 (0.75-1.50mm²)
- ③ #20: 24-20 (0.25-0.50mm²)
- ④ Contact our sales team if you need RADSOK® or alternate size contact options

Market Applications

Widely used in general and harsh environments, the LPT Series is suitable for markets including but not limited to the following:

- Industrial Instrumentation
- Security
- Telecommunications
- Robotics/Factory Automation
- Process Control
- Energy Storage
- Hybrid/Electric Vehicle
- Heavy Equipment
- Rail Mass Transit



Technical Data

Shell Material	Aluminum	
Insert Material	Plastic	
Contact	Material	Copper alloy
	Plating	Tin/Nickel/Gold plated
	Termination	Crimp
Temperature Range	-40°C to +125°C	
Ingress Protection	IP67&IP69K in the mated condition A basic dust cover or an IP67 compliant cap are available for protection in the unmated condition	
Test Current	20# contact 7.5A	
	16# contact 13A	
	12# contact 23A/35A with RADSOK®	
Recommended Operating Voltage	I # 250V	
	II# 500V	
Test Voltage AC	I # 1500V	
	II# 2300V	
Mating Cycles	500 Cycles	
Salt Spray Test	1. Black Zinc (non-conductive): 48H 2. Nickel (conductive): 48H 3. Gray Zinc Nickel (conductive): 500H	
Vibration	In accordance with test procedure EIA-364-28	
Thermal Shock	In accordance with test procedure EIA-364-32	
RoHS	Compliant	

How to Order

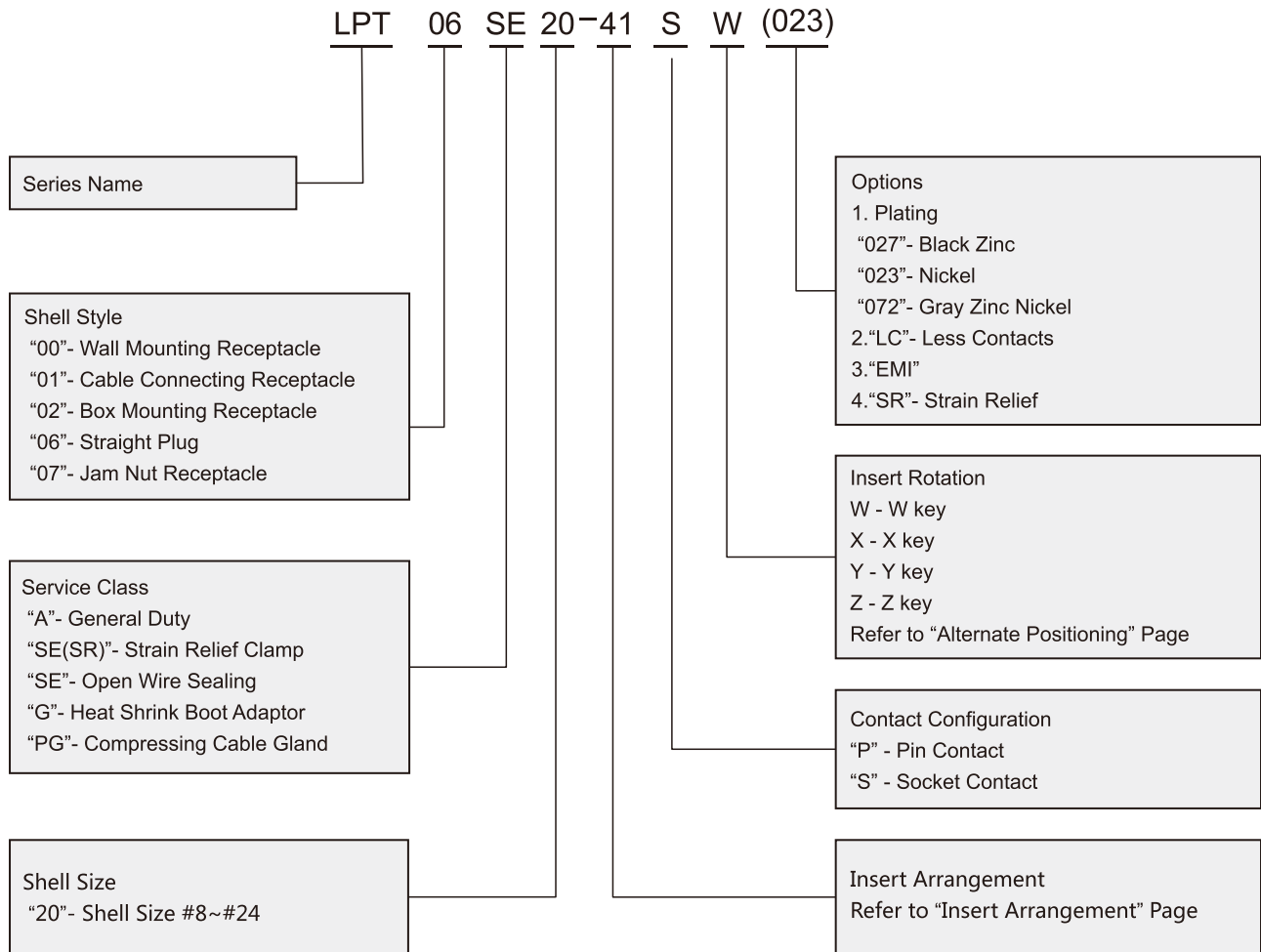

Shell Type

Wall Mounting Receptacle LPT00



Cable Connecting Receptacle LPT01



Box Mounting Receptacle LPT02



Straight Plug LPT06



Jam Nut Receptacle LPT07



Crimp Contact Ordering Information



Size	Current (A)	PIN/SOCKET	Wire		Plating	Part No	Pcs/Reel
			AWG	mm ²			
#20	7.5	PIN	22-20	0.34-0.50	Tin plating	LPTC-SF-20P-20-1	3000
					Ni plating	LPTC-SF-20P-20-2	
					Gold flash	LPTC-SF-20P-20-3	
					10u"gold plating	LPTC-SF-20P-20-4	
					30u"gold plating	LPTC-SF-20P-20-5	
		SOCKET	22-20	0.34-0.50	Tin plating	LPTC-SF-20S-20-1	
					Ni plating	LPTC-SF-20S-20-2	
					Gold flash	LPTC-SF-20S-20-3	
					10 u"gold plating	LPTC-SF-20S-20-4	
					30 u"gold plating	LPTC-SF-20S-20-5	
#16	13	PIN	16-18	0.75-1.50	Tin plating	UPTC-SF-16P-16-1	
					Ni plating	UPTC-SF-16P-16-2	
					Gold flash	UPTC-SF-16P-16-3	
					10u"gold plating	UPTC-SF-16P-16-4	
					30u"gold plating	UPTC-SF-16P-16-5	
			20-22	0.34-0.50	Tin plating	UPTC-SF-16P-20-1	
					Ni plating	UPTC-SF-16P-20-2	
					Gold flash	UPTC-SF-16P-20-3	
					10u"gold plating	UPTC-SF-16P-20-4	
					30u"gold plating	UPTC-SF-16P-20-5	
		SOCKET	16-18	0.75-1.50	Tin plating	UPTC-SF-16S-16-1	
					Ni plating	UPTC-SF-16S-16-2	
					Gold flash	UPTC-SF-16S-16-3	
					10u"gold plating	UPTC-SF-16S-16-4	
					30u"gold plating	UPTC-SF-16S-16-5	
			20-22	0.34-0.50	Tin plating	UPTC-SF-16S-20-1	
					Ni plating	UPTC-SF-16S-20-2	
					Gold flash	UPTC-SF-16S-20-3	
					10u"gold plating	UPTC-SF-16S-20-4	
					30u"gold plating	UPTC-SF-16S-20-5	
#12	23	PIN	12~14	2.00-3.50	Tin plating	LPTC-SF-12P-12-1	
					Ni plating	LPTC-SF-12P-12-2	
					Gold flash	LPTC-SF-12P-12-3	
					10u"gold plating	LPTC-SF-12P-12-4	
					30u"gold plating	LPTC-SF-12P-12-5	
		SOCKET	12~14	2.00-3.50	Tin plating	LPTC-SF-12S-12-1	
					Ni plating	LPTC-SF-12S-12-2	
					Gold flash	LPTC-SF-12S-12-3	
					10u"gold plating	LPTC-SF-12S-12-4	
					30u"gold plating	LPTC-SF-12S-12-5	

Machined Contact Ordering Information

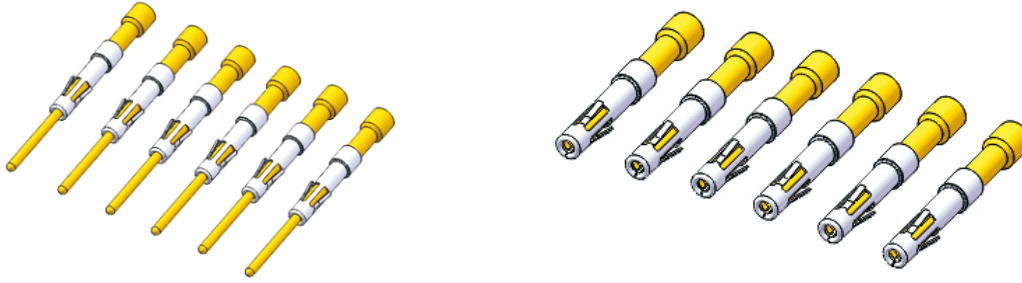

Size	Current (A)	PIN/SOCKET	Wire		Plating	Part No
			AWG	mm ²		
#20	7.5	PIN	22-20	0.34-0.50	Tin plating	LPTC-MA-20P-20-1
					Ni plating	LPTC-MA-20P-20-2
					Gold flash	LPTC-MA-20P-20-3
					10u"gold plating	LPTC-MA-20P-20-4
					30u"gold plating	LPTC-MA-20P-20-5
		SOCKET	22-20	0.34-0.50	Tin plating	LPTC-MA-20S-20-1
					Ni plating	LPTC-MA-20S-20-2
					Gold flash	LPTC-MA-20S-20-3
					10 u"gold plating	LPTC-MA-20S-20-4
					30 u"gold plating	LPTC-MA-20S-20-5
#16	13	PIN	16-18	0.75-1.50	Tin plating	UPTC-MA-16P-16-1
					Ni plating	UPTC-MA-16P-16-2
					Gold flash	UPTC-MA-16P-16-3
					10u"gold plating	UPTC-MA-16P-16-4
					30u"gold plating	UPTC-MA-16P-16-5
			20-22	0.34-0.50	Tin plating	UPTC-MA-16P-20-1
					Ni plating	UPTC-MA-16P-20-2
					Gold flash	UPTC-MA-16P-20-3
					10u"gold plating	UPTC-MA-16P-20-4
					30u"gold plating	UPTC-MA-16P-20-5
		SOCKET	16-18	0.75-1.50	Tin plating	UPTC-MA-16S-16-1
					Ni plating	UPTC-MA-16S-16-2
					Gold flash	UPTC-MA-16S-16-3
					10u"gold plating	UPTC-MA-16S-16-4
					30u"gold plating	UPTC-MA-16S-16-5
			20-22	0.34-0.50	Tin plating	UPTC-MA-16S-20-1
					Ni plating	UPTC-MA-16S-20-2
					Gold flash	UPTC-MA-16S-20-3
					10u"gold plating	UPTC-MA-16S-20-4
					30u"gold plating	UPTC-MA-16S-20-5
#12	23	PIN	12~14	2.00-3.50	Tin plating	LPTC-MA-12P-12-1
					Ni plating	LPTC-MA-12P-12-2
					Gold flash	LPTC-MA-12P-12-3
					10u"gold plating	LPTC-MA-12P-12-4
					30u"gold plating	LPTC-MA-12P-12-5
		SOCKET	12~14	2.00-3.50	Tin plating	LPTC-MA-12S-12-1
					Ni plating	LPTC-MA-12S-12-2
					Gold flash	LPTC-MA-12S-12-3
					10u"gold plating	LPTC-MA-12S-12-4
					30u"gold plating	LPTC-MA-12S-12-5

Service Classes

The LPT connector is available in the following certified service classes:



"A"	General duty; back shell is threaded for conduit attachment of MS3057 cable clamp.
"SE(SR)"	Strain relief clamp - environmental resistant strain relief clamp and grommet for moisture proofing individual wires; provides added wire bundle support.
"SE"	Open wire sealing environmental resistant, with a nut and grommet for moisture proofing individual wires.
"G"	Heat shrink boot adaptor- back shell for heat shrink boot, with optional grommet for moisture proofing individual wires.
"PG"	Compressing cable gland for moisture proofing jacketed cables with option of EMI shielding function.

Alternate Positioning

Alternate Positioning

To avoid cross-plugging problems in applications requiring the use of more than one miniature cylindrical connector of the same size and arrangement, alternate insert rotations are available as indicated in the accompanying chart.

As shown in the diagram at right, the front face of the pin insert is rotated within the shell in a clockwise direction from the normal shell key. The socket insert would be rotated counterclockwise the same number of degrees in respect to the normal shell key.

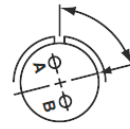

Position W

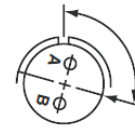

Position X

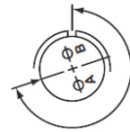

Position Y

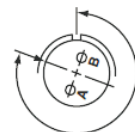



Position Z

Shell Size	Insert Arrangement	Insert Rotation			
		Degrees			
		W	X	Y	Z
8	8-4	45	97	184	-
10	10-2	45	90	315	
10	10-6	90	-	-	-
12	12-4	38	-	-	-
12	12-8	90	112	203	292
12	12-10	60	155	270	295
14	14-5	40	92	184	273
14	14-8	48	162	189	312
14	14-19	30	165	315	
14	14-AA	45	-	-	-

Shell Size	Insert Arrangement	Insert Rotation			
		Degrees			
		W	X	Y	Z
16	16-8	54	152	180	331
16	16-26	60	-	275	338
18	18-5	55	97	263	315
18	18-8	180	-	-	-
18	18-11	62	119	241	340
18	18-32	85	138	222	265
20	20-16	238	318	333	347
20	20-41	45	126	225	-
22	22-55	30	142	226	314
24	24-31	90	225	255	-

Insert Arrangements

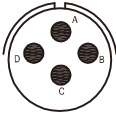
Pole	4	2	6	4
Insert Arrangement				
	8-4	10-2	10-6	12-4
Service Rating	I	I	I	I
Total Contacts	4	2	6	4
Contact No.	20	16	20	16

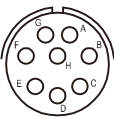
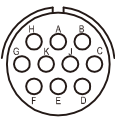
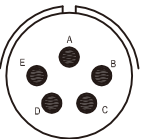
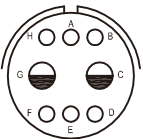
Pole	8	10	5	8
Insert Arrangement				
	12-8	12-10	14-5	14-8
Service Rating	I	I	II	I
Total Contacts	8	10	5	6 2
Contact No.	20	20	16	20 12

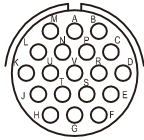
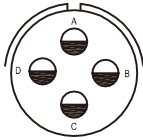
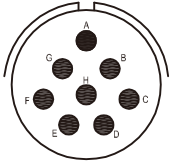
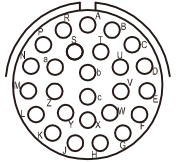
Pole	19	4	8	26
Insert Arrangement				
	14-19	14-AA	16-8	16-26
Service Rating	I	I	II	I
Total Contacts	19	4	8	26
Contact No.	20	12	16	20

Insert Arrangements

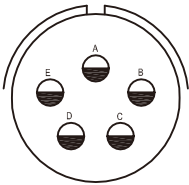
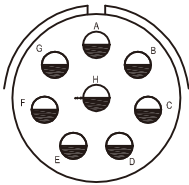
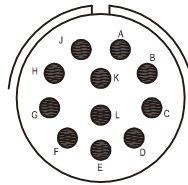
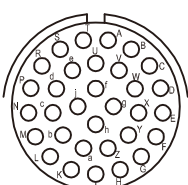
Pole	5	8	11	32
Insert Arrangement				
	18-5	18-8	18-11	18-32
Service Rating	II	I	II	I
Total Contacts	5	8	11	32
Contact No.	12	12	16	20

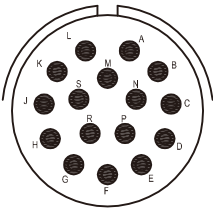
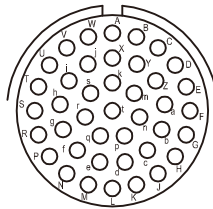
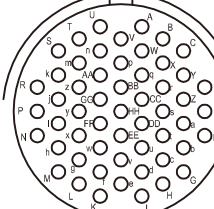
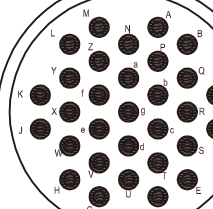
Pole	16	41	55	31
Insert Arrangement				
	20-16	20-41	22-55	24-31
Service Rating	II	I	I	I
Total Contacts	16	41	55	31
Contact No.	16	20	20	16

Product Dimensions

LPT00 (Wall Mounting Receptacle & Back Shells)

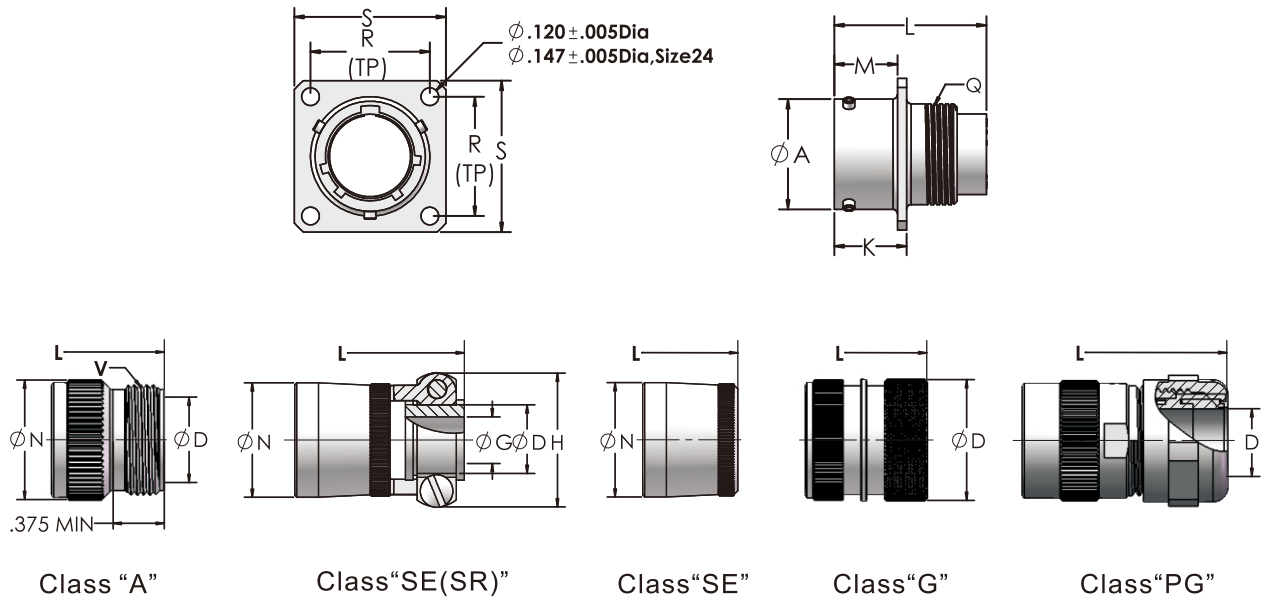

Shell size	Receptacle Front View		Receptacle side view						CLASS "A"				CLASS "SE(SR)"	
	R	S	A	M	K	L		Q	D	L	N	V	D	G
			+ .001 -.005	+ .010 -.000	+ .020 -.010	Max.		Thread Class 2A	Min.	Max.	Max.	Thread Class A	Min.	Max.
8	.594	.812	.473	.431	.493	1.27	1.056							
10	.719	.938	.590	.431	.493	1.27	1.056	.5625-24NEF	.421	1.633	.717	.6250-24NEF	.302	.188
12	.812	1.031	.750	.431	.493	.127	1.056	.6875-24NEF	.546	1.633	.834	.7500-20UNEF	.428	.312
14	.906	1.125	.875	.431	.493	.127	1.056	.8125-20UNEF	.663	1.633	.970	.8750-20UNEF	.552	.375
16	.969	1.219	1.000	.431	.493	1.27	1.056	.9375-20UNEF	.787	1.633	1.088	1.0000-20UNEF	.615	.500
18	1.062	1.312	1.125	.431	.493	1.27	1.056	1.0625-18NEF	.879	1.633	1.216	1.1875-18NEF	.740	.625
20	1.156	1.438	1.250	.556	.650	1.332	1.164	1.1875-18NEF	1.014	1.674	1.332	1.1875-18NEF	.740	.625
22	1.250	1.562	1.375	.556	.650	1.332	1.164	1.3125-18NEF	1.134	1.674	1.460	1.4375-18NEF	.928	.750
24	1.375	1.688	1.500	.589	.683	1.332	1.164	1.4375-18NEF	1.259	1.674	1.585	1.4375-18NEF	.990	.800

Shell size	CLASS "SE(SR)"				CLASS "SE"			CLASS "G"		CLASS "PG"		
	H	L		N	L		N	L	N	N	D	L
	Max.	Max.		Max.	Max.		Max.	Max.	Max.	REF	Cable range (mm)	REF
8	.812	2.354	2.202	.550	1.746	1.538	.560	1.768	.620	.571	3-6.5	2.309
10	.875	2.354	2.202	.675	1.746	1.538	0.685	1.768	.730	.814	4-8	2.309
12	1.000	2.354	2.202	0.803	1.746	1.538	0.813	1.768	.939	.814	4-8	2.309
14	1.125	2.354	2.202	0.920	1.746	1.538	0.930	1.768	.971	.930	5-10	2.309
16	1.188	2.486	2.272	1.047	1.746	1.538	1.057	1.768	1.179	1.120	10-14	2.309
18	1.438	2.486	2.272	1.165	1.746	1.750	1.175	1.768	1.266	1.180	13-18	2.309
20	1.438	2.684	2.470	1.290	1.918	1.750	1.301	1.980	1.427	1.296	13-18	2.385
22	1.625	2.684	2.470	1.418	1.918	1.750	1.430	1.980	1.522	1.496	18-25	2.385
24	1.719	2.684	2.470	1.543	1.918	1.750	1.555	1.980	1.644	1.562	18-25	2.385

Product Dimensions

LPT01 (Cable Connecting Receptacle & Back Shells)

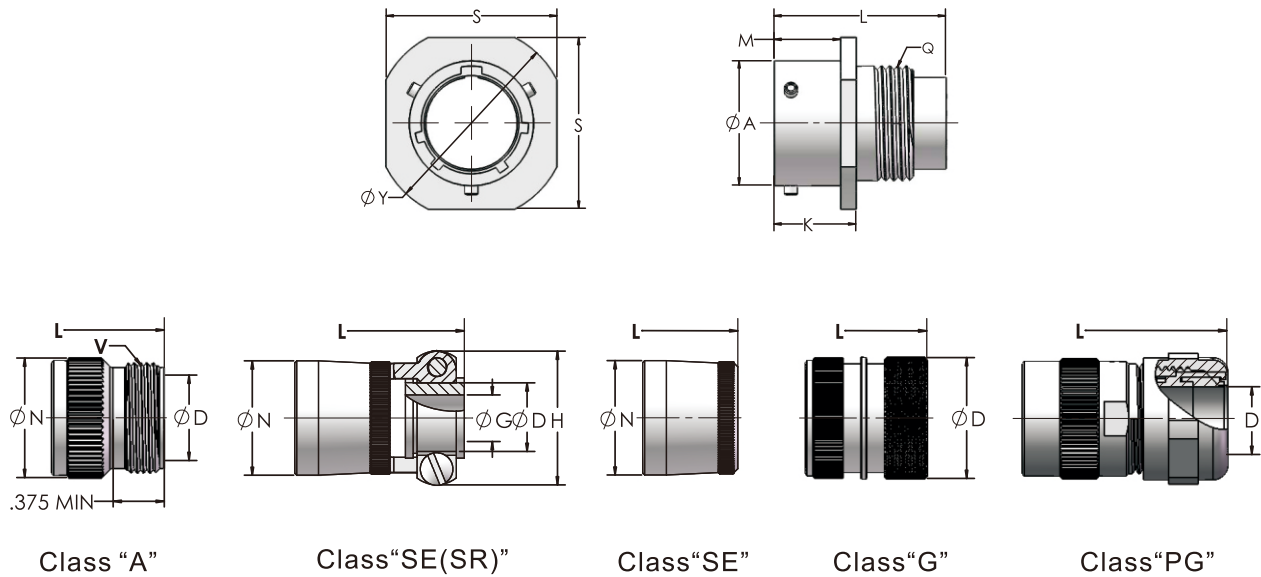

Shell size	Receptacle Front View		Receptacle side view						CLASS "A"				CLASS "SE(SR)"	
	S	Y	A	M	K	L		Q	D	L	N	V	D	G
	±.020	±.020	+ .001 - .005	+ .010 - .000	+ .020 - .010	Max. PIN SOCKET		Thread Class 2A	Min.	Max.	Max.	Thread Class A	Min.	Max.
8	.812	0.938	.473	.400	.494	1.27	1.056	.4375-28UNEF	.297	1.633	.590	.5000-28UNEF	.240	.125
10	.938	1.062	.590	.400	.494	1.27	1.056	.5625-24NEF	.421	1.633	.717	.6250-24NEF	.302	.188
12	1.031	1.156	.750	.400	.494	.127	1.056	.6875-24NEF	.546	1.633	.834	.7500-20UNEF	.428	.312
14	1.125	1.250	.875	.400	.494	.127	1.056	.8125-20UNEF	.663	1.633	.970	.8750-20UNEF	.552	.375
16	1.219	1.344	1.000	.400	.494	1.27	1.056	.9375-20UNEF	.787	1.633	1.088	1.0000-20UNEF	.615	.500
18	1.312	1.438	1.125	.400	.494	1.27	1.056	1.0625-18NEF	.879	1.633	1.216	1.1875-18NEF	.740	.625
20	1.438	1.562	1.250	.535	.650	1.332	1.164	1.1875-18NEF	1.014	1.674	1.332	1.1875-18NEF	.740	.625
22	1.562	1.688	1.375	.535	.650	1.332	1.164	1.3125-18NEF	1.134	1.674	1.460	1.4375-18NEF	.928	.750
24	1.688	1.812	1.500	.568	.683	1.332	1.164	1.4375-18NEF	1.259	1.674	1.585	1.4375-18NEF	.990	.800

Shell size	CLASS "SE(SR)"				CLASS "SE"			CLASS "G"		CLASS "PG"		
	H	L		N	L		N	L	N	N	D	L
	Max.	Max.		Max.	Max.		Max.	Max.	Max.	REF	Cable range (mm)	REF
8	.812	2.354	2.202	.550	1.746	1.538	.560	1.768	.620	.571	3-6.5	2.309
10	.875	2.354	2.202	.675	1.746	1.538	0.685	1.768	.730	.814	4-8	2.309
12	1.000	2.354	2.202	0.803	1.746	1.538	0.813	1.768	.939	.814	4-8	2.309
14	1.125	2.354	2.202	0.920	1.746	1.538	0.930	1.768	.971	.930	5-10	2.309
16	1.188	2.486	2.272	1.047	1.746	1.538	1.057	1.768	1.179	1.120	10-14	2.309
18	1.438	2.486	2.272	1.165	1.746	1.750	1.175	1.768	1.266	1.180	13-18	2.309
20	1.438	2.684	2.470	1.290	1.918	1.750	1.301	1.980	1.427	1.296	13-18	2.385
22	1.625	2.684	2.470	1.418	1.918	1.750	1.430	1.980	1.522	1.496	18-25	2.385
24	1.719	2.684	2.470	1.543	1.918	1.750	1.555	1.980	1.644	1.562	18-25	2.385

Product Dimensions

LPT02 (Box Mounting Receptacle)

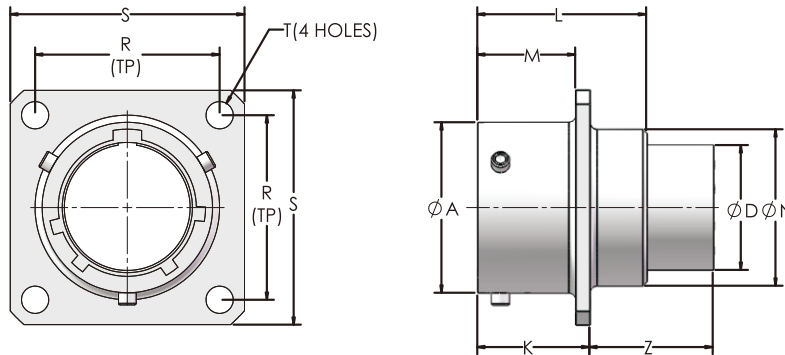

Shell size	Receptacle Front View			Receptacle side view							
	R	S	T	A	D	K	L	M	N	Z	
			±.005	+ .001 - .005	Max.	+ .020 - .010	Max.	+ .020 - .010	Dia. Max.	Max.	
										PIN	SOCKET
8	.594	.812	.120	.473	.322	.493	.825	.431	.449	.777	.563
10	.719	.938	.120	.590	.439	.493	.825	.431	.573	.777	.563
12	.812	1.031	.120	.750	.557	.493	.825	.431	.699	.777	.563
14	.906	1.125	.120	.875	.678	.493	.825	.431	.823	.777	.563
16	.969	1.219	.120	1.000	.807	.493	.825	.431	.949	.777	.563
18	1.062	1.312	.120	1.125	.908	.493	.825	.431	1.073	.777	.563
20	1.156	1.438	.120	1.250	1.033	.650	1.076	.556	1.199	.682	.514
22	1.250	1.562	.120	1.375	1.158	.650	1.076	.556	1.323	.682	.514
24	1.375	1.688	.147	1.500	1.283	.683	1.109	.589	1.449	.649	.481

Product Dimensions

LPT06 (Straight Plug & Back Shells)

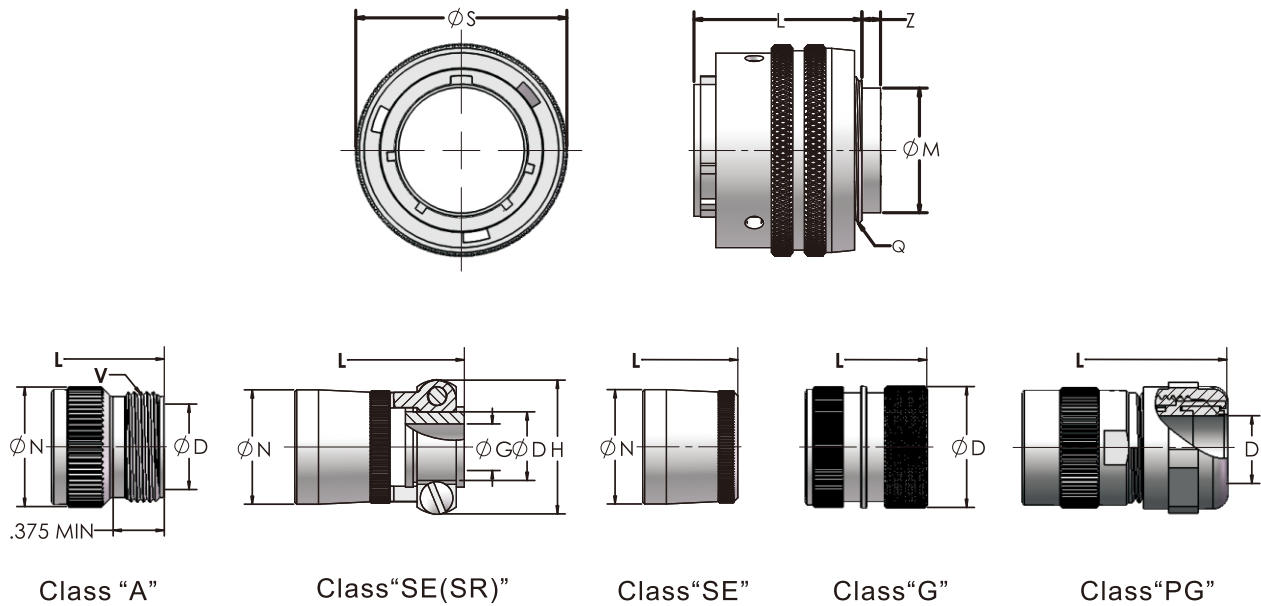

Shell size	Plug Front View	Plug Side View					CLASS "A"				CLASS "SE(SR)"	
	S	L	M	Q	Z	D	L	N	V	D	G	
	Max.	Max.	Max.	Thread Class 2A	Max. PIN SOCKET	Min.	Max.	Max.	Thread Class A	Min.	Max.	
8	.750	.928	.322	.4375-28UNEF	.324 .110	.326	1.615	.590	.5000-28UNEF	.240	.125	
10	.859	.928	.439	.5625-24NEF	.324 .110	.443	1.615	.717	.6250-24NEF	.302	.188	
12	1.031	.928	.557	.6875-24NEF	.324 .110	.557	1.615	.834	.7500-20UNEF	.428	.312	
14	1.156	.928	.678	.8125-20UNEF	.324 .110	.682	1.615	.970	.8750-20UNEF	.552	.375	
16	1.281	.928	.807	.9375-20UNEF	.324 .110	.807	1.615	1.088	1.0000-20UNEF	.615	.500	
18	1.391	.928	.908	1.0625-18NEF	.324 .110	.908	1.615	1.216	1.1875-18NEF	.740	.625	
20	1.531	1.000	1.033	1.1875-18NEF	.248 .080	1.033	1.594	1.332	1.1875-18NEF	.740	.625	
22	1.656	1.000	1.158	1.3125-18NEF	.248 .080	1.158	1.594	1.460	1.4375-18NEF	.928	.750	
24	1.776	1.000	1.283	1.4375-18NEF	.248 .080	1.283	1.594	1.587	1.4375-18NEF	.990	.800	

Shell size	CLASS "SE(SR)"			CLASS "SE"		CLASS "G"		CLASS "PG"			
	H	L		N	N	L	L	N	N	D	L
	Max.	Max.		Max.	Max.	Max.	Max.	Max.	REF	Cable range (mm)	REF
8	.812	2.336	2.122	.550	.540	1.728	1.520	1.750	.571	3-6.5	2.291
10	.875	2.336	2.122	.675	0.665	1.728	1.520	1.750	.814	4-8	2.291
12	1.000	2.336	2.122	0.803	0.793	1.728	1.520	1.750	.814	4-8	2.291
14	1.125	2.336	2.122	0.920	0.910	1.728	1.520	1.750	.930	5-10	2.291
16	1.188	2.468	2.254	1.047	1.037	1.728	1.520	1.750	1.179	10-14	2.291
18	1.438	2.468	2.254	1.165	1.155	1.728	1.520	1.750	1.266	13-18	2.291
20	1.438	2.604	2.390	1.290	1.281	1.838	1.670	1.900	1.427	13-18	2.305
22	1.625	2.604	2.390	1.418	1.410	1.838	1.670	1.900	1.522	18-25	2.305
24	1.719	2.604	2.390	1.543	1.535	1.838	1.670	1.900	1.644	18-25	2.305

Product Dimensions

LPT07 (Jam Nut Receptacle)

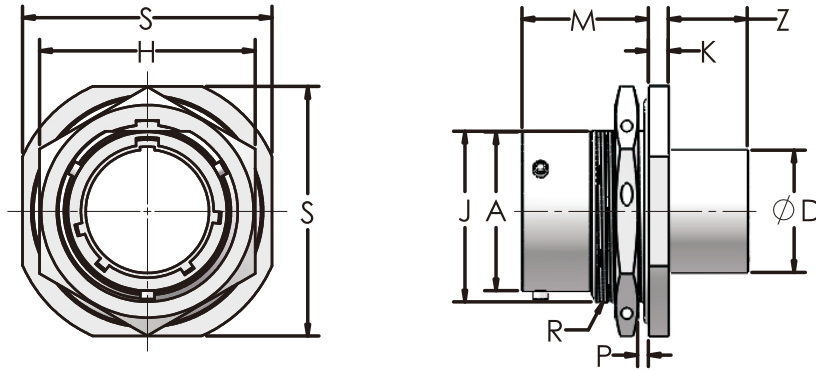

Shell size	Receptacle Front View					Receptacle side view							
	H ±.016	S	A	D	J Flat	K	M	P Panel thickness		R	Z		
			+ .001	Dia.	+ .001			+ .011	Min.	Max.	Thread	Max.	
			- .005	Max.	- .005			- .010				PIN	SOCKET
Class 2A UNEF													
8	.750	.938	.473	.322	.530	.125	.696	.062	.125	.5625-24	.450	.235	
10	.875	1.062	.590	.439	.655	.125	.696	.062	.125	.6875-24	.450	.235	
12	1.062	1.250	.750	.557	.818	.125	.696	.062	.125	.8750-20	.450	.235	
14	1.188	1.375	.875	.678	.942	.125	.696	.062	.125	1.0000-20	.450	.235	
16	1.312	1.500	1.000	.807	1.066	.125	.696	.062	.125	1.1250-18	.450	.235	
18	1.438	1.625	1.125	.908	1.191	.125	.696	.062	.125	1.2500-18	.450	.235	
20	1.562	1.812	1.250	1.033	1.316	.156	.884	.062	.250	1.3750-18	.292	.124	
22	1.688	1.938	1.375	1.158	1.441	.156	.884	.062	.250	1.5000-18	.292	.124	
24	1.816	2.062	1.500	1.283	1.566	.156	.917	.062	.250	1.6250-18	.260	.092	

Assembly Instructions for Straight Plug

1. STRIP INSULATION

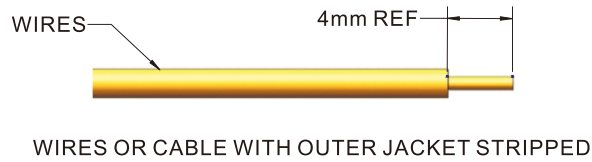

2. CRIMP CONTACTS IN ACCORDANCE WITH THE IPC-A-620 SPECIFICATION.

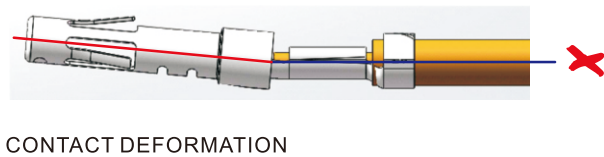
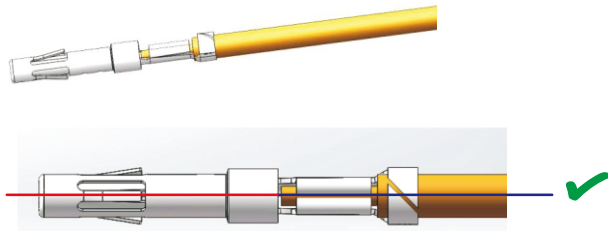

3. CONTACT INSERTION/REMOVAL TOOL INFORMATION



Part Number	Description
TOOL-738651-020	for #20 male/female contact
TOOL-738651-016	for #16 male/female contact
TOOL-738651-012	for #12 male/female contact

STEP BY STEP ASSEMBLY PROCESS

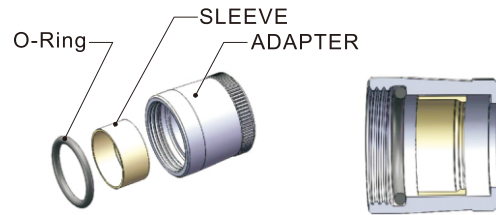

STEP1: PUSH THE SLEEVE AND O-RING INTO THE ADAPTER.

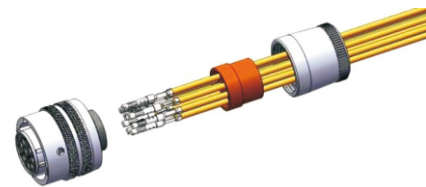

STEP2: PASS THE TERMINATED CONTACTS THROUGH THE ADAPTER AND GROMMET.

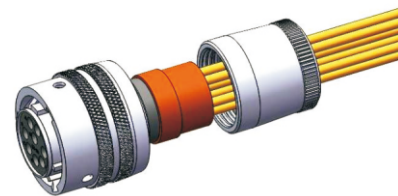

STEP3: ALIGN THE CONTACTS INTO THEIR CORRESPONDING INSERT HOLES. THEN SLIDE THE GROMMET UP THE WIRES CLOSE TO INSERT.

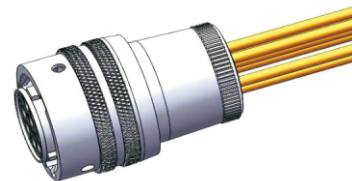

STEP4: USE A RECEPTACLE (IF POSSIBLE) AS A FIXTURE, SCREW ADAPTER ON TO BACK SHELL.

North America

Amphenol Industrial Product Group

191 Delaware Avenue
Sidney, NY 13838-1395-USA

Telephone: 888-364-9011 Fax: 520-397-7169

www.amphenol-industrial.com

Asia

Amphenol Technology (Zhuhai) Co., Ltd.

Address: No. 63, Xingnan Rd, Phase 2, Science and Technology
Industrial Park, Sanzao Town, Jinwan, Zhuhai, PRC

Tel: (86)756-3989725 Fax: (86) 756-3989768

www.amphenol-industrial.com



Notice: Specifications are subject to change without notice. Contact your nearest Amphenol Corporation Sales Office for the latest specifications. All statements, information and data given herein are believed to be accurate and reliable but are presented without guarantee, warranty, or responsibility of any kind expressed or implied. Statements or suggestions concerning possible use of our products are made without representation or warranty that any such use is free of patent infringement and are not recommendations to infringe any patent. The user should not assume that all safety measures are indicated or that other measures may not be required. Specifications are typical and may not apply to all connectors.