

LBW Flush Mount 22mm Switches & Pilot Lights

Flush bezel projects only 2mm from front of panel. Removable contact blocks are ideal for single board mounting.

Key Features

- Pushbuttons, illuminated pushbuttons, selector switches, and key selector switches with up to 3PDT contacts.
- Key selectors with keys that are difficult to duplicate. Seven different key numbers to choose from.
- Pilot lights with round or square flat lenses.
- Solder / Tab or PC Board terminal.
- Black or metallic flush bezels available.
- Guard pushbuttons, illuminated or non-illuminated are available.
- Illuminated pushbuttons with bright, clear, ring, flush or extended lens.
- Choice of either gold-clad or silver contacts.
- Degree of protection: IP65 (from the front of the panel).



Applicable Standards	Mark	File No. or Organization
UL508		UL Recognition No.E55996
CSA 22.2 No.14		CSA File No. LR 21451
EN60947-5-1		TÜV Rheinland
		EU Low Voltage Directive
GB14048.5		

Specifications

Operating Temperature	-25 to +60°C (no freezing), Illuminated units: -25 to +55°C
Storage Temperature	-30 to +80°C (no freezing)
Operating Humidity	45 to 85% RH (no condensation)
Contact Resistance	50 mW maximum (initial value)
Insulation Resistance	100 MW minimum (500V DC megger)
Dielectric Strength	Switch Between live part and ground: 2,000V AC, 1 min. Between terminals of different poles: 2,000V AC, 1 min. Between terminals of the same poles: 1,000V AC, 1 min.
	Illumination Between live part and ground: 2,000V AC, 1 min.
Vibration Resistance	Operating extremes/Damage limits: 5 to 55 Hz, amplitude 0.5mm
Shock Resistance	Operating extremes: 100 m/s ² Damage limits: 1,000 m/s ²
Mechanical Life (minimum operations)	Momentary: 2,000,000 Maintained: 250,000 Selector switches: 250,000 Key selector switches: 250,000
Electrical Life (minimum operations)	Momentary: 50,000 / 100,000 ¹ Maintained: 50,000 / 100,000 ² Selector switches: 50,000 / 100,000 ² Key selector switches: 50,000 / 100,000 ²
Degree of Protection	IP65 (IEC 60529)
Terminal Style	Solder/tab terminal #110, PC board terminal
Bezel	Black plastic or metallic
Weight (approx.)	16g (illuminated pushbutton)
	14g (pilot light)
	15g (pushbutton)
	17g (selector switch)
	29g (key switch)
	17g (illuminated pushbutton with guard) 18g (push button with guard)

1. Switching frequency 1,800 operations/h.
2. Switching frequency 1,200 operations/h.

Contact Ratings

Gold Contact (switch base color: blue)			
Rated Insulation Voltage	250V		
Rated Thermal Current	3A		
Rated Operating Voltage	30V DC	125V AC	
Rated Operating Current (resistive load)	0.1A	0.1A	
Contact Material	Gold-clad silver		

Minimum applicable load (reference value): 5V AC/DC, 1 mA

Silver Contact (switch base color: gray)					
Rated Insulation Voltage	250V				
Rated Operating Voltage	30V	125V	250V		
Rated Operating Current	AC 50/60Hz	Resistive load	—	5A	5A
		Inductive load	—	3A	1.5A
	DC	Resistive load	5A	1.1A	—
		Inductive load	2.5A	0.55A	—
	AC 50/60Hz	Resistive load	—	5A	3A
		Inductive load	—	3A	1.5A
DC	Resistive load	3A	0.6A	—	
	Inductive load	1A	0.22A	—	
Rated Thermal Current	5A				
Contact Material	Silver				

AC inductive load: PF=0.6 to 0.7 DC inductive load: L/R=7 ms max.

LED Ratings

Rated Voltage	5V DC	12V AC/DC	24V AC/DC
Voltage Range	5V DC±5%	12V AC/DC±10%	24V AC/DC ±10%
LED Part No.	LB9Z-LED5②	LB9Z-LED1②	LB9Z-LED2②

Rated Current	A, R: 22 mA G, PW, S: 16 mA
Voltage Rating	Marked on the side of the LED unit
LED Life (reference value)	Approx. 30,000 hours (until the brightness reduces to 50% of the initial value)

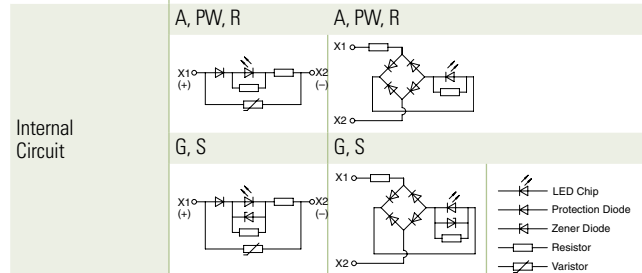

1. For ② (color code): A (amber), G (green), PW (white), R (red), S (blue)
2. Use the white LED for yellow illumination.
3. LED lamp contains a current-limiting resistor.

Switches & Pilot Devices

Signaling Lights

Relays & Sockets

Timers

Contactors

Terminal Blocks

Circuit Breakers

Illuminated Pushbuttons (Assembled)



① Style	② Operation	④ Contact	⑤ LED Operating Voltage	Part No.	* Illumination Color Code
Black bezel	Momentary	Gold/SPDT	24V AC/DC	LBW①L-M③T14*	Specify the color code in place of * in the Part No. A: amber G: green PW: pure white R: red S: blue Y: yellow
		Gold/DPDT		LBW①L-M③T24*	
	Maintained	Gold/SPDT	24V AC/DC	LBW①L-A③T14*	
		Gold/DPDT		LBW①L-A③T24*	
Metallic bezel	Momentary	Gold/SPDT	24V AC/DC	LBW①L-M③T14*	
		Gold/DPDT		LBW①L-M③T24*	
	Maintained	Gold/SPDT	24V AC/DC	LBW①L-A③T14*	
		Gold/DPDT		LBW①L-A③T24*	
Guard Type	Momentary	Gold/SPDT	24V AC/DC	LBW①L-M③T14*	
		Gold/DPDT		LBW①L-M③T24*	
	Maintained	Gold/SPDT	24V AC/DC	LBW①L-A③T14*	
		Gold/DPDT		LBW①L-A③T24*	

- Flush/Extended color code: A (amber), G (green), PW (pure white), R (red), S (blue), Y (yellow)
- Ring-illuminated color code: PW (pure white), WA (amber), WG (green), WR (red), WS (blue)
- Illuminated pushbuttons contain an LED unit. For details on LED units, see 580.
- The guard opens 180 degrees spring-return.
- Illuminated pushbuttons can be used with legend markings. Engraving can be done on a marking plate which is placed in the lens, or a clear film can be printed and placed in the lens. See 594 for details on the marking plate and film.
- White lens type (when light is off) are available. Clear lens is used instead of colored lens for amber, green, red, and blue illuminated pushbuttons. Amber, green, red, or blue LED units are used. To specify, see Part Number Interpretation below.
- PC board terminals available for gold contacts. Silver contacts also available. To specify, see Part Number Interpretation below.
- Extended style is available. See Part Number Interpretation below (③).
- Flush ring-illuminated style is available. See Part Number Interpretation below (③). Guard is not available with flush ring-illuminated style.
- 5V DC and 12V AC/DC LED operating voltages also available.
- Marking plates are available. See accessory section.

Part Number Interpretation

LBW①L-②③T④⑤⑥*



To be used for interpreting part numbers only, not for part number development.

① Style

Code	Shape
6	Round / Black Bezel
7	Square / Black Bezel
6M	Round / Metallic Bezel
7M	Square / Metallic Bezel
6G	Round with Guard
7G	Square with Guard

② Operation

Code	Operation
A	Maintained
M	Momentary

③ Operator Style

Code	Operator Style
1	Flush
2	Extended
1R	Flush Ring-illuminated

* Extended style is available only for round (black/metallic bezel) and in momentary operation. Guard model is not available.

④ Contacts

Code	Contact
1	Gold/SPDT
2	Gold/DPDT
5	Silver/SPDT
6	Silver/DPDT

⑤ LED Operating Voltage

Code	Rated Operating Voltage
1	5V DC
3	12V AC/DC
4	24V AC/DC

⑥ Others

Code	Specification	Part No. Example
Blank	Solder/Tab Terminal	—
V	PC Board Terminal (Gold Contact Only)	LBW6L-M1T14V*

• Specify the color code in place of * in the table above.

Illuminated Pushbuttons (Sub-assembled)



Contact Block

Terminal Style	Material	Contact	Part Number
	Silver	SPDT	LB-T50
		DPDT	LB-T60
	Gold	SPDT	LB-T10V
		DPDT	LB-T20V

LED Module

Style	Color	Voltage	Part Number
	Amber	5V	LB9Z-LED5A
		12V	LB9Z-LED1A
		24V	LB9Z-LED2A
	Green	5V	LB9Z-LED5G
		12V	LB9Z-LED1G
		24V	LB9Z-LED2G
	Red	5V	LB9Z-LED5R
		12V	LB9Z-LED1R
		24V	LB9Z-LED2R
	Blue	5V	LB9Z-LED5S
		12V	LB9Z-LED1S
		24V	LB9Z-LED2S
	Pure White	5V	LB9Z-LED5PW
		12V	LB9Z-LED1PW
		24V	LB9Z-LED2PW

Operator

Style	Mounting Style	Shape	Momentary	Maintained
	Flush Mount (Plastic)	Round	LBW6L-M0	LBW6L-A0
		Square	LBW7L-M0	LBW7L-A0
	Flush Mount (Metallic)	Round	LBW6ML-M0	LBW6ML-A0
		Square	LBW7ML-M0	LBW7ML-A0
	Flush Mount (Built-in switch guard)	Round	LBW6GL-M0	LBW6GL-A0
		Square	LBW7GL-M0	LBW7GL-A0
	Flush Mount (Plastic)	Round (for extended lens)	LBW6L-M20	LBW6L-A20
			Flush Mount (Metallic)	LBW6ML-M20

Lens

Shape	Color	Part Number
	Amber	LBW6A-L1A
	Green	LBW6A-L1G
	Red	LBW6A-L1R
	Blue	LBW6A-L1S
	White	LBW6A-L1W
	Yellow	LBW6A-L1Y
	Amber	LBW6A-L2A
	Green	LBW6A-L2G
	Red	LBW6A-L2R
	Blue	LBW6A-L2S
	White	LBW6A-L2W
	Yellow	LBW6A-L2Y
	Amber	LBW7A-L1A
	Green	LBW7A-L1G
	Red	LBW7A-L1R
	Blue	LBW7A-L1S
	White	LBW7A-L1W
	Yellow	LBW7A-L1Y
Round Ring Flush	White	LBW6A-L1R-W
Square Ring Flush	White	LBW7A-L1R-W

Note: No marking plate used in ring illuminated pushbuttons.

Dimensions

All dimensions in mm.

Flush/Ring-illuminated

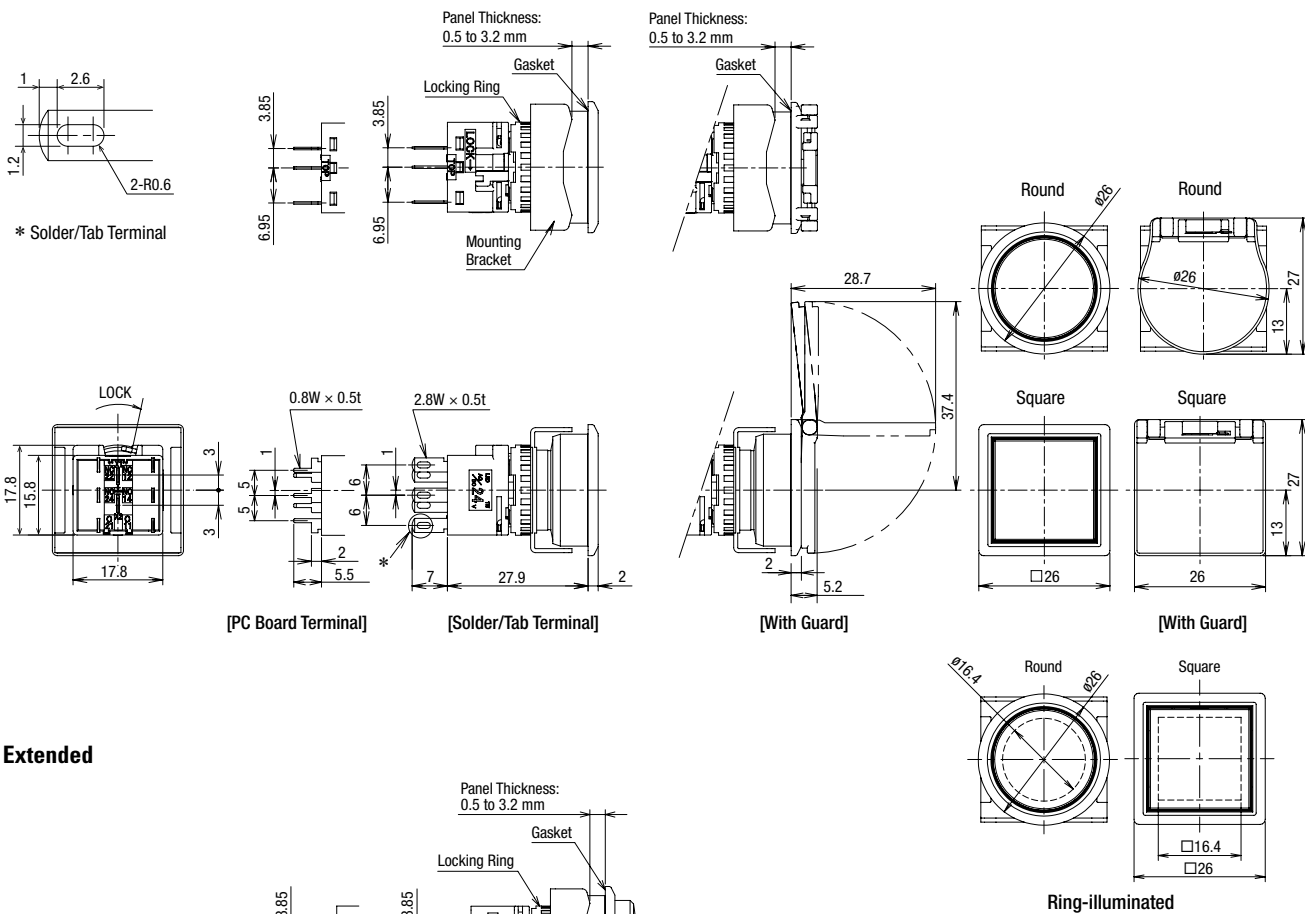

Extended

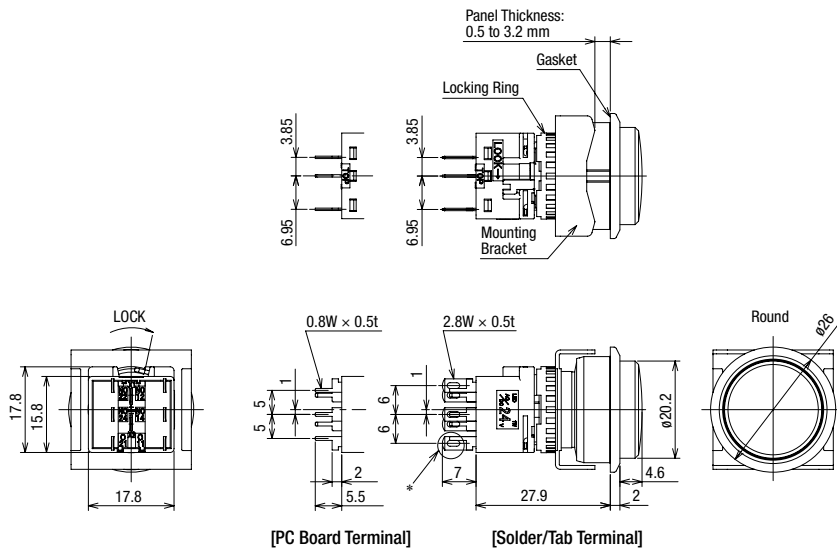

Terminal Arrangement (Bottom View)

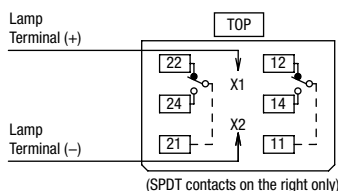

- For details on pc board and circuit design, see 594.
- For details on single board mounting, see 593.

Pilot Lights

LBW①P-1T0②③*

Part No.



Round / Black Bezel



Square / Black Bezel



Round / Metallic Bezel



Square / Metallic Bezel

① Style	③ LED Operating Voltage	Part No.	* Illumination Color Code
Black Bezel	24V AC/DC	LBW①P-1T04*	Specify the color code in place of * in the Part No. A: amber G: green PW: pure white R: red S: blue Y: yellow
Metallic Bezel	24V AC/DC	LBW①P-1T04*	

- Pilot lights contain an LED unit. For maintenance LED units see 583.
- Legends and symbols can be engraved on a marking plate or film to be inserted under the lens by users for labelling purposes. See 596 for details.
- White lens type (when light is off) are available. Clear lens is used instead of colored lens for amber, green, red, and blue pilot lights. Amber, green, red, or blue LED units are used. To specify, see Part Number Interpretation below.
- PC board terminals available. To specify, see Part Number Interpretation below.
- 5V DC and 12V AC/DC LED operating voltages also available.

Part Number Interpretation

LBW①P-1T0②③*



To be used for interpreting part numbers only, not for part number development.

① Style

Code	Shape
6	Round / Black Bezel
7	Square / Black Bezel
6M	Round / Metallic Bezel
7M	Square / Metallic Bezel

② LED Operating Voltage

Code	Rated Operating Voltage
1	5V DC
3	12V AC/DC
4	24V AC/DC

③ Others



Code	Specification	Part No. Example
Blank	Solder/Tab Terminal	—
V	PC Board Terminal	LBW6P-1T04V*

- Specify the color code in place of * in the table above.

Pilot Lights (Sub-assembled)





Contact Block

Terminal Style	Part Number
 Solder Tab	LB-T00
 PCB	LB-T00V



LED Module

Style	Color	Voltage	Part Number
	Amber	5V	LB9Z-LED5A
		12V	LB9Z-LED1A
		24V	LB9Z-LED2A
	Green	5V	LB9Z-LED5G
		12V	LB9Z-LED1G
		24V	LB9Z-LED2G
	Red	5V	LB9Z-LED5R
		12V	LB9Z-LED1R
		24V	LB9Z-LED2R
	Blue	5V	LB9Z-LED5S
		12V	LB9Z-LED1S
		24V	LB9Z-LED2S
	Pure White	5V	LB9Z-LED5PW
		12V	LB9Z-LED1PW
		24V	LB9Z-LED2PW

Operator

Style	Mounting Style	Shape	Part Number
	Flush Mount (Plastic)	Round	LBW6P-0
		Square	LBW7P-0
	Flush Mount (Metallic)	Round	LBW6MP-0
		Square	LBW7MP-0

Lens

Shape	Color	Part Number
	Amber	LBW6A-P1A
	Green	LBW6A-P1G
	Red	LBW6A-P1R
	Blue	LBW6A-P1S
	White	LBW6A-P1W
	Yellow	LBW6A-P1Y
	Amber	LBW7A-P1A
	Green	LBW7A-P1G
	Red	LBW7A-P1R
	Blue	LBW7A-P1S
	White	LBW7A-P1W
	Yellow	LBW7A-P1Y

Switches & Pilot Devices

Signaling Lights

Relays & Sockets

Timers

Contactors

Terminal Blocks

Circuit Breakers

Dimensions

All dimensions in mm.

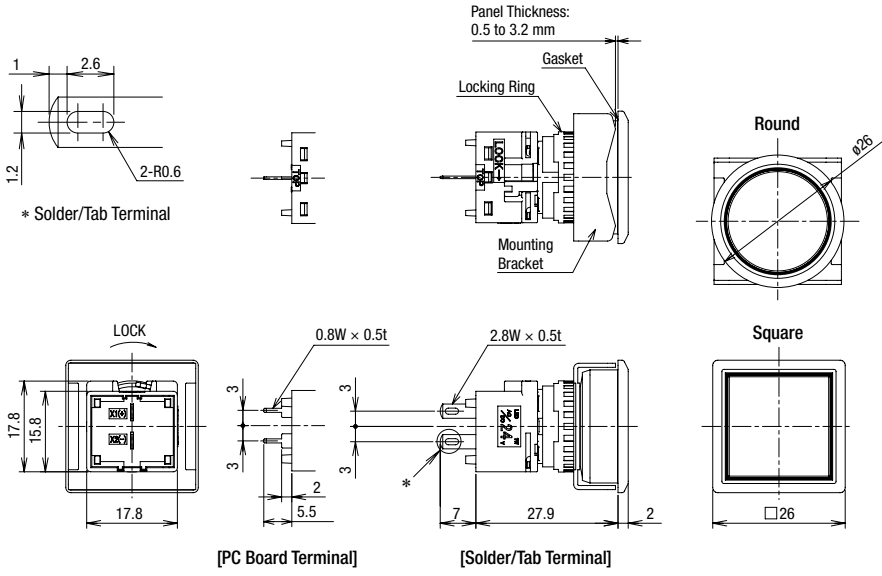

Terminal Arrangement (Bottom View)

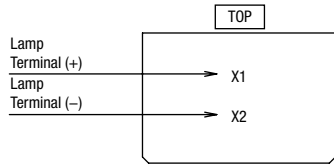

Pushbuttons

LBW①B-②③T④⑤*

Flush



Round / Black Bezel



Square / Black Bezel



Round / Metallic Bezel



Square / Metallic Bezel



Round with Guard



Square with Guard

Extended



Round only (metallic bezel available)

① Style	② Operation	③ Button Shape	Part No.	* Illumination Color Code
Black bezel	Momentary	Flush Round	LBW6B-M1T1④⑤	Specify the color code in place of * in the Part No. B: black G: green R: red S: blue W: white Y: yellow
		Flush Square	LBW7B-M1T1④⑤	
		Extended Round	LBW6B-M1T2④⑤	
	Maintained	Flush Round	LBW6B-A1T1④⑤	
		Flush Square	LBW7B-A1T1④⑤	
		Extended Round	LBW6B-A1T2④⑤	
Metallic bezel	Momentary	Flush Round	LBW6MB-M1T1④⑤	
		Flush Square	LBW7MB-M1T1④⑤	
		Extended Round	LBW6MB-M1T2④⑤	
	Maintained	Flush Round	LBW6MB-A1T1④⑤	
		Flush Square	LBW7MB-A1T1④⑤	
		Extended Round	LBW6MB-A1T2④⑤	
Guard Type	Momentary	Flush Round	LBW6GB-M1T1④⑤	
		Flush Square	LBW7GB-M1T1④⑤	
	Maintained	Flush Round	LBW6GB-A1T1④⑤	
		Flush Square	LBW7GB-A1T1④⑤	

- The guard opens 180 degrees spring-return.
- PC board terminals available for gold contacts. To specify, see Part Number Interpretation below.
- Pushbuttons can be used with legend markings engraved on marking plates and lens buttons with clear film inserted in the lens is available. To specify, see Part Number Interpretation below. See for details on the marking plate and film.
- Extended pushbuttons available. To specify, see Part Number Interpretation below. Pushbuttons with guard is not available. Extended pushbuttons is available with momentary operation only.

Part Number Interpretation

LBW①B-②③T④⑤*



To be used for interpreting part numbers only, not for part number development.

① Style

Code	Shape
6	Round / Black Bezel
7	Square / Black Bezel
6M	Round / Metallic Bezel
7M	Square / Metallic Bezel
6G	Round with Guard
7G	Square with Guard

② Operation

Code	Operation
A	Maintained
M	Momentary

③ Operator Style

Code	Operation
1	Flush
2	Extended *

* Extended style is available only for round (black/metallic bezel) and in momentary operation. Guard model is not available.

④ Contacts

Code	Contact	Code	Contact
1	Gold/SPDT	5	Silver/SPDT
2	Gold/DPDT	6	Silver/DPDT
3	Gold/3PDT	7	Silver/3PDT

⑤ Others

Code	Specification	Part No. Example
Blank	Solder/Tab Terminal	—
L (Note 1)	Lens	LBW6B-M1T1L*
V	PC Board Terminal (Gold Contact Only)	LBW6B-M1T1V*
VL (Note 1)	PC Board Terminal with Lens (Gold Contact Only)	LBW6B-M1T1VL*

Note 1: Codes L and VL are available with flush operator only.

- Color code (*) for lens:
A (amber), B (translucent lens with black nameplate), G (green), R (red), S (blue), W (white), Y (yellow)

Pushbuttons (Sub-assembled)



Contact Block

Terminal Style	Material	Contact	Part Number
	Silver	SPDT	LB-T5
		DPDT	LB-T6
		3PDT	LB-T7
	Gold	SPDT	LB-T1V
		DPDT	LB-T2V
		3PDT	LB-T3V

Operator

Style	Bezel Style	Shape	Momentary	Maintained
	Black plastic bezel	Round	LBW6L-M0	LBW6L-A0
		Square	LBW7L-M0	LBW7L-A0
	Metallic bezel	Round	LBW6ML-M0	LBW6ML-A0
		Square	LBW7ML-M0	LBW7ML-A0
	Plastic bezel with built-in switch guard	Round	LBW6GL-M0	LBW6GL-A0
		Square	LBW7GL-M0	LBW7GL-A0
	Flush Mount (Plastic)	Round (for extended lens)	LBW6L-M20	LBW6L-A20
	Flush Mount (Metallic)		LBW6ML-M20	LBW6ML-A20

Button

Style	Color	Part Number
	Black	LBW6A-B1B
	Green	LBW6A-B1G
	Red	LBW6A-B1R
	Blue	LBW6A-B1S
	White	LBW6A-B1W
	Yellow	LBW6A-B1Y
	Black	LBW6A-B2B
	Green	LBW6A-B2G
	Red	LBW6A-B2R
	Blue	LBW6A-B2S
	White	LBW6A-B2W
	Yellow	LBW6A-B2Y
	Black	LBW7A-B1B
	Green	LBW7A-B1G
	Red	LBW7A-B1R
	Blue	LBW7A-B1S
	White	LBW7A-B1W
	Yellow	LBW7A-B1Y

Dimensions

All dimensions in mm.

Flush Pushbutton

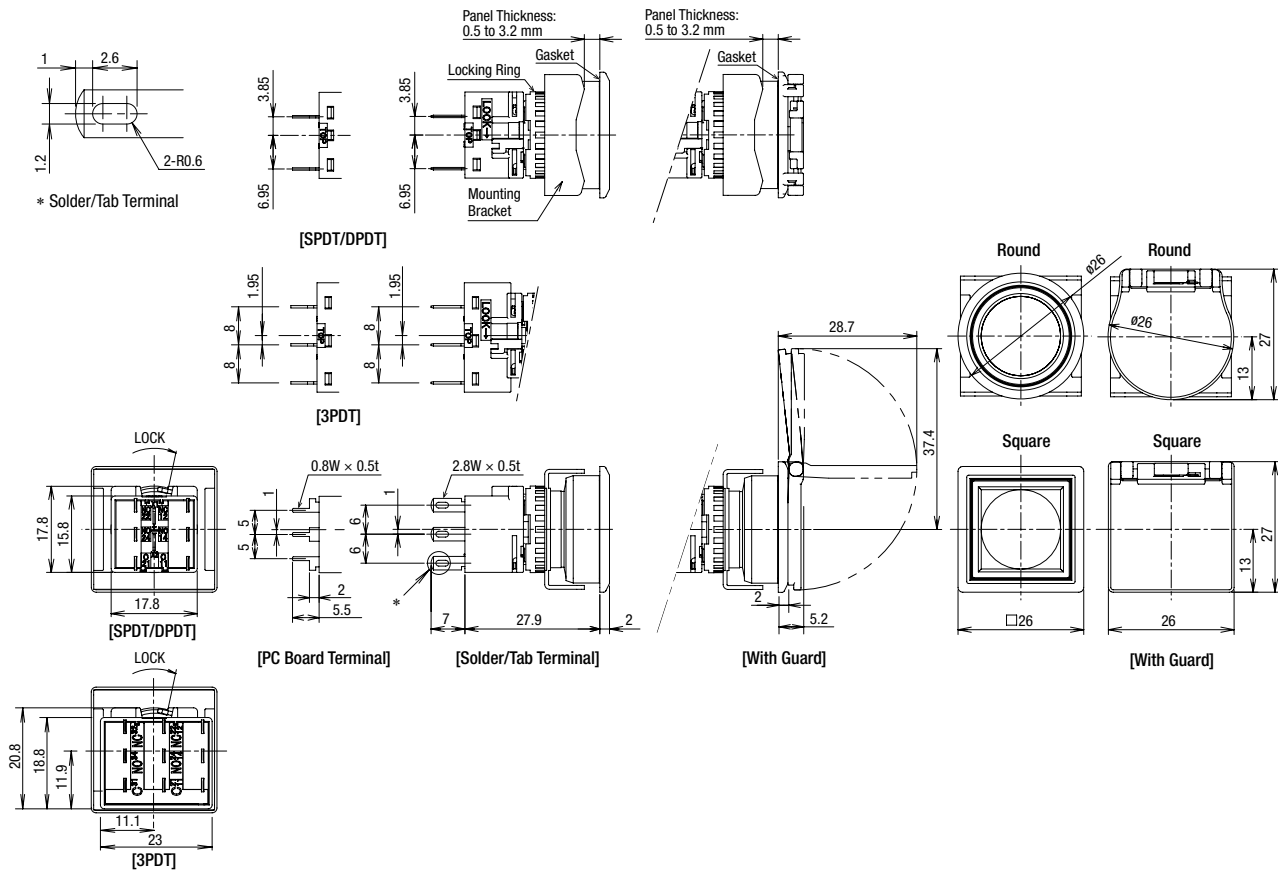

Extended Pushbutton

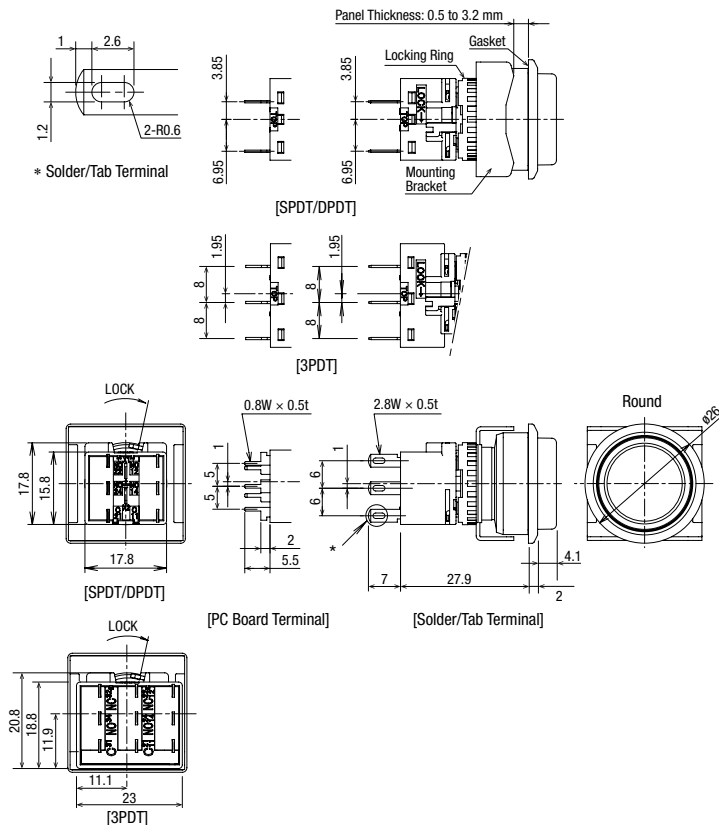

Terminal Arrangement (Bottom View)

SPDT/DPDT Contacts

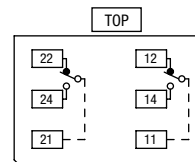





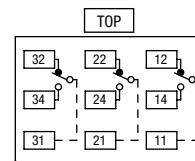





(SPDT contacts on the right only)

3PDT Contacts



- For details on mounting hole layout, see 593.
- For details on pc board and circuit design, see 594.
- For details on single board mounting, see 593.

Selector Switches

Part No.	LBW①S-②T③④						
				Round / Black Bezel	Square / Black Bezel	Round / Metallic Bezel	Square / Metallic Bezel
	① Style	② Operator Position		③ Contact	Part No.		
					Gold Contact	Silver Contact	
Black bezel	90° 2-position	Maintained		SPDT	LBW①S-2T1	LBW①S-2T5	
				DPDT	LBW①S-2T2	LBW①S-2T6	
				3PDT	LBW①S-2T3	LBW①S-2T7	
	45° 3-position	Maintained		DPDT	LBW①S-3T2	LBW①S-3T6	
				3PDT	LBW①S-3T3	LBW①S-3T7	
		Spring return two-way		DPDT	LBW①S-33T2	LBW①S-33T6	
Metallic bezel	90° 2-position	Maintained		SPDT	LBW①S-2T1	LBW①S-2T5	
				DPDT	LBW①S-2T2	LBW①S-2T6	
				3PDT	LBW①S-2T3	LBW①S-2T7	
	45° 3-position	Maintained		DPDT	LBW①S-3T2	LBW①S-3T6	
				3PDT	LBW①S-3T3	LBW①S-3T7	
		Spring return two-way		DPDT	LBW①S-33T2	LBW①S-33T6	
			DPDT	LBW①S-33T3	LBW①S-33T7		

- PC board terminals available for gold contacts. To specify, see Part Number Interpretation below.
- For contact operation, see 556.

Part Number Interpretation

LBW①S-②T③④



To be used for interpreting part numbers only, not for part number development.

① Style

Code	Shape
6	Round / Black Bezel
7	Square / Black Bezel
6M	Round / Metallic Bezel
7M	Square / Metallic Bezel

② Operator Position

2-position

Operator Position

2 Maintained



3-position

Operator Position

3 Maintained



33 Spring return two-way



③ Contacts

Code	Contact
1	Gold/SPDT (90° 2-position only)
2	Gold/DPDT
3	Gold/3PDT
5	Silver/SPDT (90° 2-position only)
6	Silver/DPDT
7	Silver/3PDT



④ Others

Code	Specification	Part No. Example
Blank	Solder/Tab Terminal	—
V	PC Board Terminal (Gold Contact Only)	LBW6S-2T1V

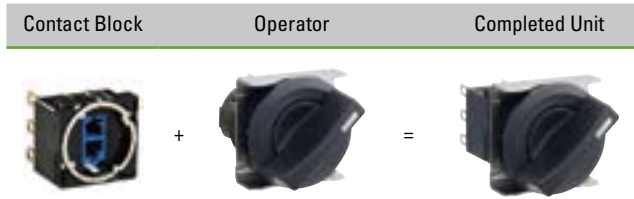
Selector Switches (Sub-assembled)



Contact Block

Terminal Style	Material	Contact	Part Number	
	Solder/Tab	Silver	SPDT	LB-T5
			DPDT	LB-T6
			3PDT	LB-T7
	PCB	Gold	SPDT	LB-T1V
			DPDT	LB-T2V
			3PDT	LB-T3V

SPDT contacts applicable for 2-position switches only.

Operator

Style	Shape	Position	Function	Part Number
 Round	Round	2	Maintained	LBW6S-2Y
		3	Maintained	LBW6S-3Y
			Spring from both	LBW6S-33Y
 Square	Square	2	Maintained	LBW7S-2Y
		3	Maintained	LBW7S-3Y
			Spring from both	LBW7S-33Y
 Round	Round	2	Maintained	LBW6MS-2Y
		3	Maintained	LBW6MS-3Y
			Spring from both	LBW6MS-33Y
 Square	Square	2	Maintained	LBW7MS-2Y
		3	Maintained	LBW7MS-3Y
			Spring from both	LBW7MS-33Y

Key Selector Switches

Part No.	LBW ① K - ② ③ T ④ ⑤ - ⑥						
	Wave Key				Disc Tumbler Key		
	Round / Black Bezel	Square / Black Bezel	Round / Metallic Bezel	Square / Metallic Bezel	Round / Metallic Bezel	Square / Metallic Bezel	
① Style	② Operator Position		⑤ Key Removable Position	⑥ Contact	Part No.		
					Gold Contact	Silver Contact	
Black bezel	90° 2-position	Maintained	A: Key removable in all positions		SPDT	LBW ① K-2ST1A	LBW ① K-2ST5A
					DPDT	LBW ① K-2ST2A	LBW ① K-2ST6A
	45° 3-position	Maintained	A: Key removable in all positions		DPDT	LBW ① K-3ST2A	LBW ① K-3ST6A
					3PDT	LBW ① K-3ST3A	LBW ① K-3ST7A
Metallic bezel	90° 2-position	Maintained	A: Key removable in all positions		SPDT	LBW ① K-2ST1A	LBW ① K-2ST5A
					DPDT	LBW ① K-2ST2A	LBW ① K-2ST6A
	45° 3-position	Maintained	A: Key removable in all positions		DPDT	LBW ① K-3ST2A	LBW ① K-3ST6A
					3PDT	LBW ① K-3ST3A	LBW ① K-3ST7A

- For operator position, see Part Number Interpretation below.
- For key removable position, see Part Number Interpretation below. The key cannot be removed in a spring returned position.
- Two keys are supplied.
- Besides the standard key (key number 0H), six other keys are available.
- Disc tumbler keys also available. Only the standard key is available. To specify, see Part Number Interpretation below.
- PC board terminals available for gold contacts. To specify, see Part Number Interpretation below.
- For contact operation, see 593.

Part Number Interpretation

LBW ① K - ② ③ T ④ ⑤ - ⑥



To be used for interpreting part numbers only, not for part number development.

① Style

Code	Shape
6	Round / Black Bezel
7	Square / Black Bezel
6M	Round / Metallic Bezel
7M	Square / Metallic Bezel

② Operator Position

Code	Operator Position
2	90° 2-position maintained
3	45° 3-position maintained
33	45°-3-position spring return two-way

③ Key Style

Code	Key Style
S	Wave key
Blank	Disc tumbler key

④ Contacts

Code	Contact
1	Gold/SPDT (90° 2-position only)
2	Gold/DPDT
3	Gold/3PDT
5	Silver/SPDT (90° 2-position only)
6	Silver/DPDT
7	Silver/3PDT

⑤ Key Removal Position

2-position

Key Removable Position

A: Key removable in all positions	B: Key removable at left position only

3-position

Key Removable Position

A: Key removable in all positions	D: Key removable at center only

⑥ Key Number (for wave keys only)

Code	
0H or Blank	Standard key
1H to 2H	Reversible key
3H to 6H	Non-reversible key

Others

Code	Specification	Part No. Example
Blank	Solder/Tab Terminal	—
V	PC Board Terminal (Gold Contact Only)	LBW6K-2T1VA

3-position

Spring return two-way



- Key removable at L, C, R.
- Key retained at L, R.

Key Selector Switches (Sub-assembled)

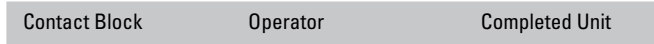

Contact Block

Terminal Style	Material	Contact	Part Number	
	Solder/Tab	Silver	SPDT	LB-T5
			DPDT	LB-T6
			3PDT	LB-T7
	PCB	Gold	SPDT	LB-T1V
			DPDT	LB-T2V
			3PDT	LB-T3V

Operator

Style	Shape	Position	Function	Key Style	Key Remove Position	Part number		
	Round	2	90° 2-position maintained	Disc tumbler key	All positions	LBW6K-2A		
					Left	LBW6K-2B		
				Wave key	All positions	LBW6K-2SA		
		Left			LBW6K-2SB			
		3		45° 3-position maintained	Disc tumbler key	All positions	LBW6K-3A	
						Center	LBW6K-3D	
			Wave key		All positions	LBW6K-3SA		
		Center			LBW6K-3SD			
		45°-3-position spring return two-way	Disc tumbler key		All positions	LBW6K-33D		
	Center				LBW6K-33SD			
	Wave key		Center	LBW6K-33SD				
	Square	2	90° 2-position maintained	Disc tumbler key	All positions	LBW7K-2A		
					Left	LBW7K-2B		
				Wave key	All positions	LBW7K-2SA		
					Left	LBW7K-2SB		
				3	45° 3-position maintained	Disc tumbler key	All positions	LBW7K-3A
							Center	LBW7K-3D
		Wave key	All positions			LBW7K-3SA		
Center			LBW7K-3SD					
45°-3-position spring return two-way		Disc tumbler key	All positions	LBW7K-33D				
	Center		LBW7K-33SD					
	Wave key	Center	LBW7K-33SD					

Style	Shape	Position	Function	Key Style	Key Remove Position	Part number		
	Round	2	90° 2-position maintained	Disc tumbler key	All positions	LBW6MK-2A		
					Left	LBW6MK-2B		
				Wave key	All positions	LBW6MK-2SA		
					Left	LBW6MK-2SB		
				3	45° 3-position maintained	Disc tumbler key	All positions	LBW6MK-3A
							Center	LBW6MK-3D
	Wave key	All positions	LBW6MK-3SA					
		Center	LBW6MK-3SD					
	45°-3-position spring return two-way	Disc tumbler key	Center	LBW6MK-33D				
			Wave key	LBW6MK-33SD				
		Square	2	90° 2-position maintained	Disc tumbler key	All positions	LBW7MK-2A	
	Left					LBW7MK-2B		
Wave key	All positions				LBW7MK-2SA			
	Left				LBW7MK-2SB			
3	45° 3-position maintained				Disc tumbler key	All positions	LBW7MK-3A	
						Center	LBW7MK-3D	
		Wave key	All positions	LBW7MK-3SA				
Center			LBW7MK-3SD					
45°-3-position spring return two-way		Disc tumbler key	Center	LBW7MK-33D				
			Wave key	LBW7MK-33SD				

Switches & Pilot Devices

Signaling Lights

Relays & Sockets

Timers

Contactors

Terminal Blocks

Circuit Breakers

Dimensions

All dimensions in mm.

Key Selector Switches with Wave Key

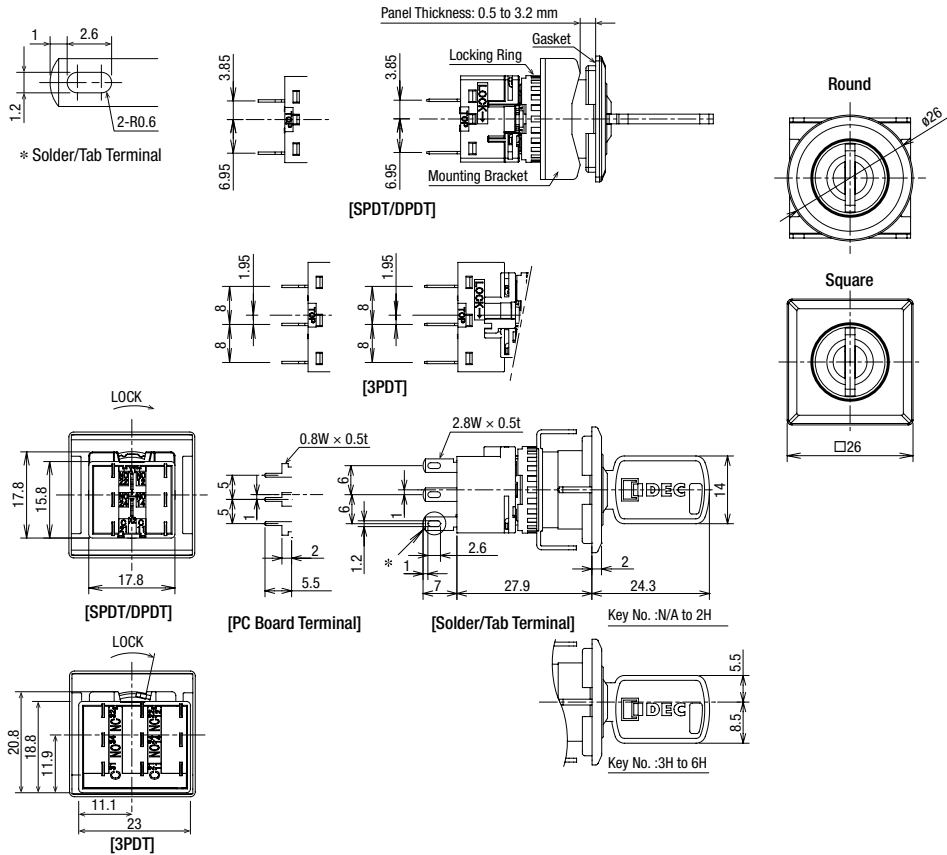

Key Selector Switches with Disc Tumbler Key

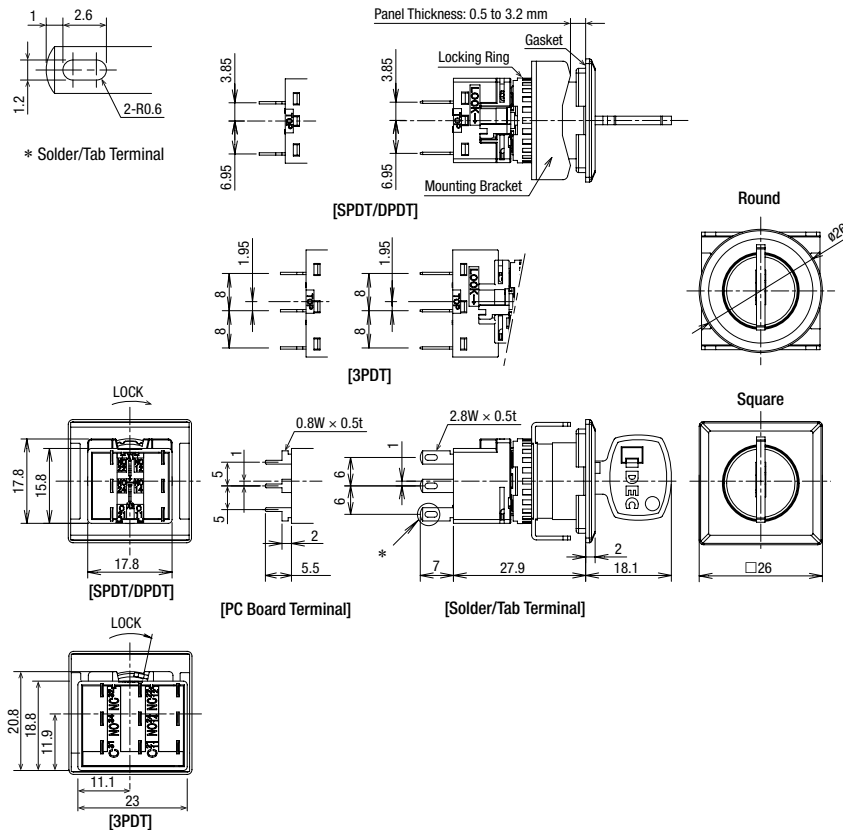

Terminal Arrangement (Bottom View)

SPDT/DPDT Contacts

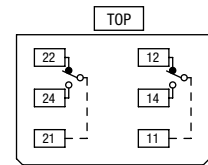

(SPDT contacts on the right only)

3PDT Contacts

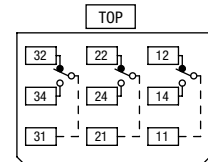

- For details on mounting hole layout, see **593**.
- For details on pc board and circuit design, see **594**.
- For details on single board mounting, see **593**.

Contact Operation

Selector Switch, Illuminated Selector Switch, Key Selector Switch

Operator Position & Contact Operation (Top View)								
Position		Contact	Left	Center	Right			
90° 2-position	<p>Maintained</p>	<p>Spring return from right</p>	SPDT					
			DPDT					
			3PDT					
45° 3-position	<p>Maintained</p>	<p>Spring return from right</p>	<p>Spring return from left</p>	<p>Spring return two-way</p>	DPDT			
					3PDT			

Mounting Hole Layout (mm)

LBW Series Flush Bezel (LBW6/LBW6M/LBW6G)

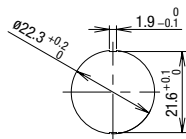

LBW Series Flush Bezel LBW6/LBW6M/LBW6G

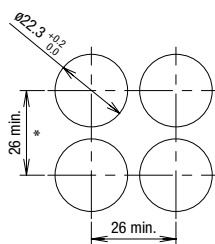

* 53 mm minimum for switches with guard

LBW Series Flush Bezel LBW7/LBW7M/LBW7G

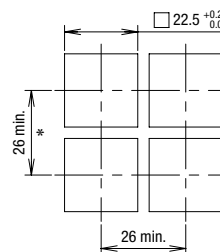

Single Board Mounting

IDEC's LBW Series is available for single board mounting.

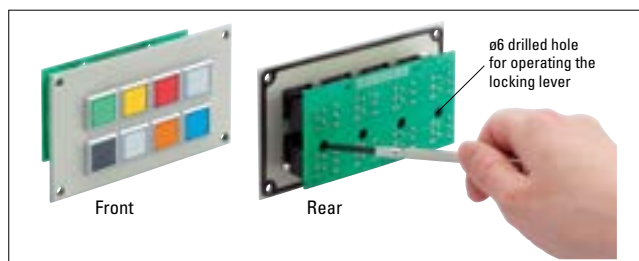

Assembly Procedure

1. Install the operator to the panel.
 2. Mount the contact block to the operator from the rear.
 3. Turn the locking lever to lock the contact block.
 4. Insert the PC board to terminals and solder.
- Note 1: Make sure that each terminal is inserted into the PC board correctly.
 Note 2: Do not apply tensile force to the connector cable for an extended period of time.
 Note 3: Do not expose the contact block to water.
 Note 4: Ensure to lock contact blocks when the contact blocks are installed on the operators. UP series can be installed on the same board. For details, see 599.

Installing and Removing Contact Blocks

Turn the locking lever to install and remove contact blocks on the PC using a screwdriver from a hole in the PC board. See "Notes for Designing PC Board and Circuit" on 594. Determine the location of the switches so that the locking lever can be operated. See "Removing and Installing the Contact Block" on 598.

Mounting Holes and Assembly Procedure

Drill mounting holes in the panel as shown below. When the units are mounted collectively, provide adequate clearance.

Notes for Designing PC Board and Circuit

All dimensions in mm.

- Use 1.6-mm-thick glass epoxy PC board with drilled holes.
- Design a circuit so that the LBW series can operate within the rated voltage and current range. Make sure that inrush current and voltage do not exceed the rating.
- Minimum applicable load is 5V AC/DC, 1 mA on gold contacts. Applicable range is subject to the operating condition and load.
- Since the ø2.8-mm-wide terminal touches the PC board as shown on the right, short circuit may occur with pattern lines. Design a circuit that prevents short circuits.

SPDT/DPDT Contacts

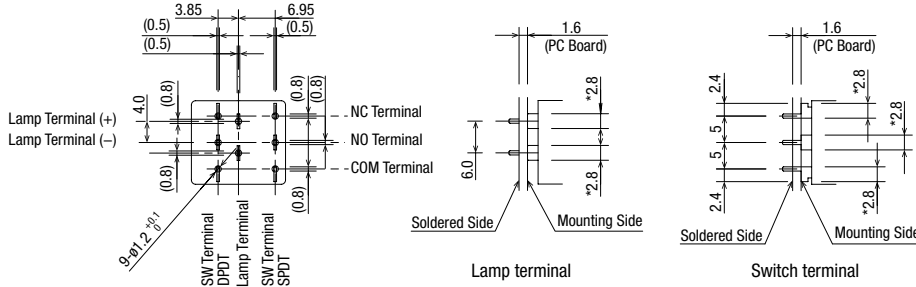

3PDT Contacts

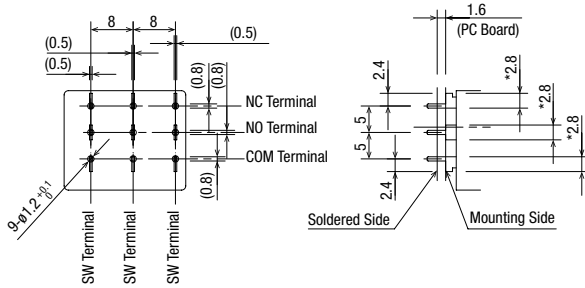

PC Board Drilling Layout (Bottom View)

SPDT/DPDT Contacts

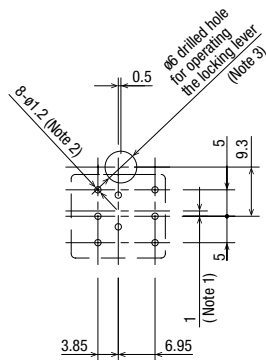

3PDT Contacts

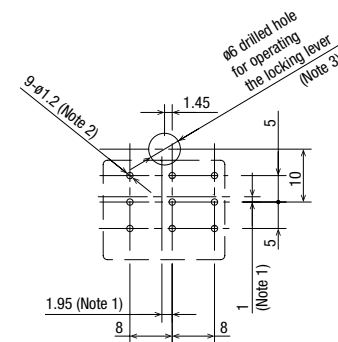









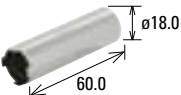



Note 1: When designing, note the alignment of center lines of the contact blocks and center lines of the operators.

Note 2: The diameter of the terminal hole is ø1.2.

Note 3: Hole diameter may vary to meet installation requirements. Determine the location and the size of the hole so that the locking lever can be operated.

Accessories

Shape	Specification	Part No.	Remarks	
Locking Ring Wrench 	Metal (Nickel-plated brass)	MT-001	Used to tighten the locking ring when installing the units on to the panel.	
For Standard Bezels Lens Removal Tool 	Stainless Steel	MT-101	Used to remove the lens or button. (for standard bezels)	
For LBW Series Flush Bezels Mounting Hole Plug  	1. For round units (LBW6/LBW6M) [Plug] Polyamide (Black) [Gasket] Nitrile rubber	LBW9Z-BS6*	* Color code: blank (black), W (white) Degree of protection: IP65 Panel thickness: 0.5 to 3.2 mm See 596 for dimensions.	
	2. For square units (LBW7/LBW7M) [Mounting Plate] Stainless Steel	LBW9Z-BS7*		
	Mounting Hole Plug 	Metal [Plug] Zinc diecast [Locking Ring] Polyamide [Gasket] Nitrile rubber		LW9Z-BM
	Mounting Hole Plug 	Rubber Nitrile rubber		LW9Z-BP1
Terminal Cover  	1. For SPDT/DPDT contacts PBT (White)	LB9Z-VL2	See 596 for dimensions. See 598 for mounting.	
	2. For 3PDT contacts PBT (White)	LB9Z-VL3		
Key  Reversible key  Non-reversible key 	For key selector switches (wave key) Metal (zinc nickel-plated)	LA9Z-SK-*	Specify a key number in place of * in the Part No. Blank: Standard key 0H (reversible) 1H to 2H: Reversible key 3H to 6H: Non-reversible key See 596 for dimensions.	
Keys 	For key selector switches (disc tumbler key) Metal (brass nickel-plated) 18×1.8×25.1 t1.8	AS6-SK-132		

Switches & Pilot Devices

Signaling Lights

Relays & Sockets

Timers

Contactors

Terminal Blocks

Circuit Breakers

Accessories

Shape		Material / Dimensions (W×H×D)	Part No.	Remarks
Lens 	1. For round flush units	Polyarylate ø20 H4	HA9Z-L11*	Specify the color code in place of * in the part no. A: Amber, C: Clear, G: Green, R: Red, S: Blue, Y: Yellow Note: Use a clear lens for pure white (PW) illumination.
	2. For square flush units	Polyarylate ø20 H4	HA9Z-L21*	
	3. For round extended units	Polyarylate ø20.2 H7.8	LBW9Z-L12*	
Buttons 	1. For round flush units	Polyacetal ø20 H3.2 (L5)	HA9Z-B11*	Specify the color code in place of * in the part no. B: Black, G: Green, R: Red, S: Blue W: White, Y: Yellow
	2. For square flush units	Polyacetal ø20 H3.9 (L5)	HA9Z-B21*	
	3. For round extended units	Polyacetal ø19.8 H7.3 (L9.1)	HA9Z-B12*	
Marking plate 	1. For round flush units	Acrylic ø17 t0.85 (L1.1)	HA9Z-P1*	Specify the color code in place of * in the part no. B: Black, W: White
	2. For square units	Acrylic □18.4 t0.85	HA9Z-P2*	
	3. For extended units	Acrylic ø15 t3.0	LBW9Z-P12W	
Anti-rotation Ring 	LBW series	Metal (Stainless steel) 25×8.2×24.8 t0.8	LBW9Z-LP6	
Locking ring 	All models	Polyamide ø17.9 H3.9	LB9Z-LN	

Dimensions for Accessories

All dimensions in mm.

For round units (LBW9Z-BS6*)

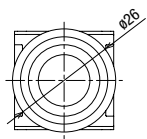

Mounting Hole Layout

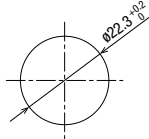

For round units (LBW9Z-BS6*)

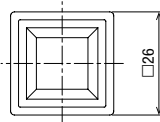

Mounting Hole Layout

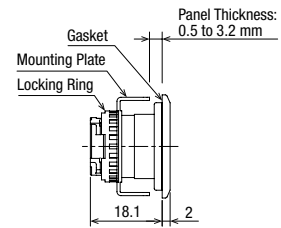
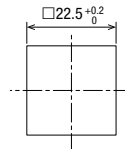

Terminal Cover

For SPDT/DPDT contacts (LB9Z-VL2)

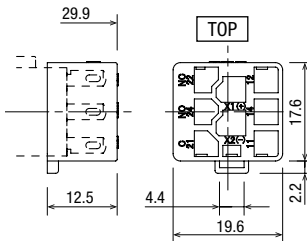

For 3PDT contacts (LB9Z-VL3)

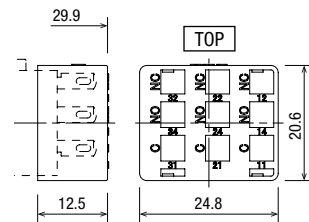

Key (Wave Key)

Reversible key

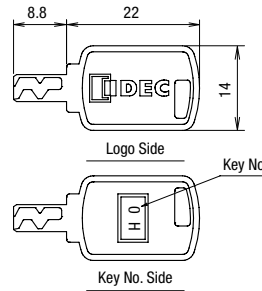

Non-reversible key

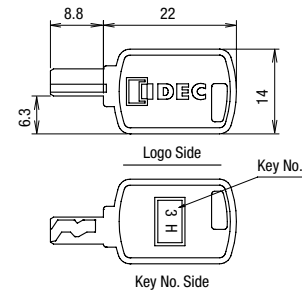

Maintenance Parts

Maintenance LED Unit

Package Quantity: 1

Shape	Rated Operating Voltage	Part No. (Ordering No.)	* Color Code
	5V DC	LB9Z-LED5*	A: Amber G: Green
	12V AC/DC	LB9Z-LED1*	PW: Pure White R: Red
	24V AC/DC	LB9Z-LED2*	S: Blue W: White

- Use a pure white (PW) LED unit for yellow (Y) illumination.

Transformer

Package Quantity: 1

Transformer	Primary Voltage	Secondary Voltage	Part No. (Ordering No.)	Applicable Load
	100/110V AC	100/110V AC ±10%	TWR512	LB9Z-LED2* (24V AC/DC LED unit)
	200/220V AC	200/220V AC ±10%	TWR522	
	400/440V AC	400/440V AC ±10%	TWR542	

- Terminal cover (TWR-VL3) is supplied as standard.
- Connect one LB9Z-LED2* to a transformer.

Specifications

Part No.	TWR5□2
Operating Voltage	100/110V AC, 200/220V AC, 400/440V AC (50/60Hz)
Current Draw	2.4VA
Rated Insulation Voltage	600V
Insulation Resistance	100 MΩ minimum (500V DC megger)
Operating Temperature	-30 to +60°C (no freezing)
Storage Temperature	-40 to +80°C (no freezing)
Operating Humidity	35 to 85% RH (no condensation)
Vibration Resistance	Damage Limits: 30 Hz, amplitude 1.5 mm Operating extremes: 5 to 55 Hz, amplitude 0.5 mm
Shock Resistance	Damage limits: 1,000 m/s ² Operating Extremes: 100 m/s ²
Dielectric Strength	2,500V AC, 1 minute
Terminal Screw	M3.5
Applicable Wire	2 mm ² maximum, 2 wires maximum
Weight (approx.)	87g

Dimensions

All dimensions in mm.

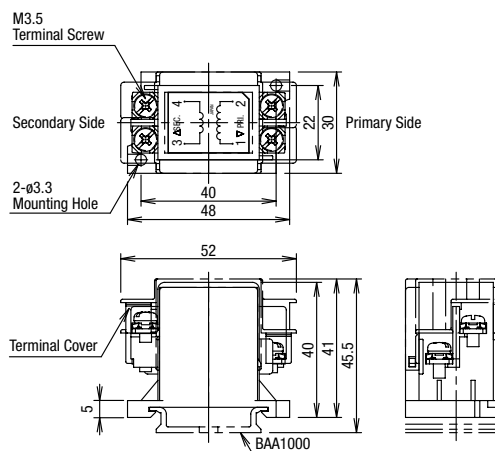

- Use end clip BC9Z-E/N35NPN10 when using 400/440V AC primary voltage transformers.

Precautions & Instructions  **Safety Precautions**

- Turn off the power to the LBW series control units before installation, removal, wiring, maintenance, and inspection. Failure to turn power off may cause electrical shocks or fire hazard.
- To avoid burning your hand, use the lamp holder tool when replacing the lamps.

- For wiring, use wires of a proper size to meet voltage and current requirements. Solder correctly according to the instructions in "Wiring" and "Notes on Terminal Cover." Improper soldering may cause overheating and create a fire hazard. Also, when using tab terminals, use receptacles of appropriate size.

Instructions

Wiring

1. Solder the terminals at 350°C within 3 seconds using a 60W soldering iron. Sn-Ag-Cu type is recommended. When soldering, do not touch the LB series with the soldering iron. Also ensure that no tensile force is applied to the terminals. Do not bend the terminal or apply excessive force to the terminal.
2. Use non-corrosive liquid flux.

Terminal Cover

Solder/tab terminal

Insert the terminal cover into the contact block with the TOP markings on the contact block and the terminal cover in the same direction.

Note: When wiring, insert the lead wires into the terminal cover holes before soldering. After wiring, terminal covers cannot be installed.

Standard Bezel



Flush Bezel



Operating Environment

- Do not use the LB series where corrosive gases exist or under an environment exceeding the operating temperature and humidity ranges. Otherwise, damage such as contact failure or change of the surface color may occur.
- Major parts of the switch are plastic. Scratches or damage may occur when scraped with a sharp object or if excessive load or shock is applied. Note that this may cause operation and appearance failure of the operator and bezel.
- Application of detergent, cutting oil, or special chemicals to the switch may result in operation and/or appearance failure such as a change in surface color.

Handling

Contacts (micro switch)

When using NC (normally closed) and NO (normally open) contacts of the same microswitch, avoid connections of different voltages, or connections of different types of power supplies. Failure to observe this instruction may cause a short-circuit.

Removing and Installing the Contact Block

3. Turn the locking lever on the contact block in the direction opposite to the arrow on the housing. Then the contact block can be removed.
4. Insert the contact block with the TOP markings on the contact block and the operator placed in the same direction. Then lock the units, turning the locking lever in the direction of the arrow.

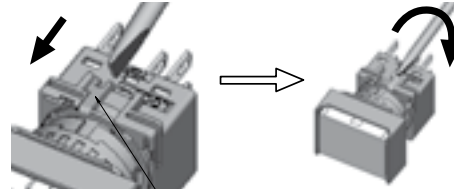

locking lever

Panel Mounting

Remove the contact block from the operator. Insert the operator into the panel cut-out from the front, then install the contact block to the operator.

Flush Bezel

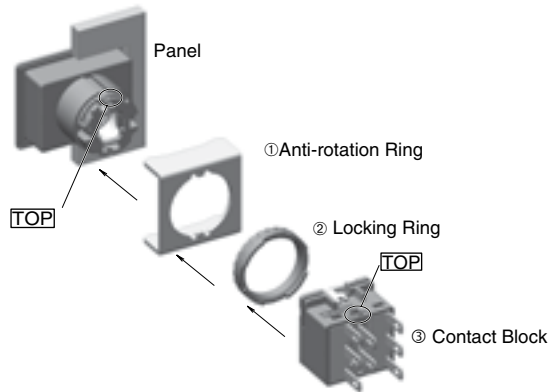

Notes on Mounting

Use the optional ring wrench (MT-001) to mount the operator onto the panel. Tightening torque should not exceed 0.7 N·m. Do not use pliers. Excessive tightening will damage the locking ring.

Mounts on the same panel as LB/LBW series

- Three illumination colors: Green (G), red (R), and white (W)

Specifications

Color Code	Red (R), White (W)	G (Green)
Rated Current (I)	7mA	2mA
Maximum Current (I _a : 25°C)	Reverse Voltage (V _R)	9V / 5V
	Operating Temperature (T _{opr})	-25 to +55°C (no freezing)
	Storage Temperature (T _{stg})	-30 to +80°C (no freezing)
Forward Voltage (V _f)	Standard value: 2V (I _f =7mA)	Standard value: 2.7V (I _f =2 mA)
Dielectric Voltage	Between live and dead parts: 500V AC, 1 minute	
Weight (approx.)	4.3g (UP8-89V1), 5.1g (UP8-89V2)	



UP Series

Mounting Hole Size	Shape	Degree of Protection (IEC 60529)	Matching LB/LBW Mounting Style	Part No.	Illumination Color Code
ø8 UP8	Shroud	IP40	Standard Bezel	UP8-89V1*	Specify the color code in place of * in the Part No. G: green R: red W: white
			Flush Bezel	UP8-89V2*	
ø9 UP9P	Shroud	IP65	Standard bezel Flush bezel	UP9P-99V1*	

- LED cannot be replaced.

Note: Connect an external current limiting resistor in series. Otherwise, the LED may be damaged.

Dimensions

All dimensions in mm.

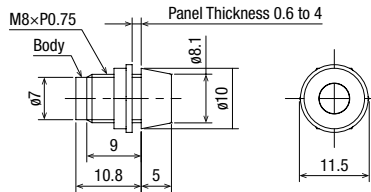
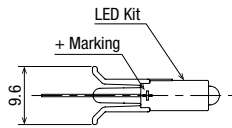
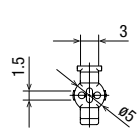

UP8-89V1

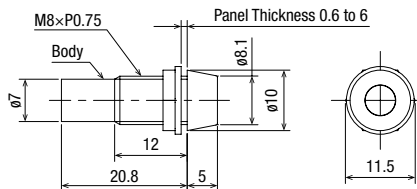

UP8-89V2

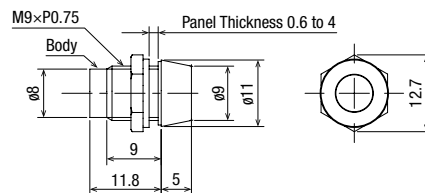

UP9P-99V1

[Assembly Drawing]

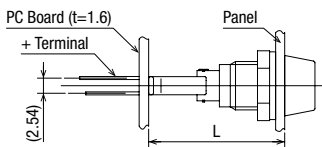

Dimensions (L)

Standard Bezel	22.5mm
Flush Bezel	29.9mm

PC Board Mounting Hole

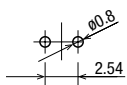

Panel Cut-out

UP8

UP9P



Internal Circuit

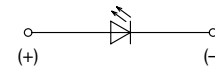

The longer pin is the positive terminal

! Safety Precautions

- Turn off power to the unit before installation, removal, wiring, maintenance, and inspection. Failure to turn off may cause electrical shocks or fire hazard.
- For wiring, use wires of a proper size to meet the voltage and current requirements.
- Improper soldering or failure to tighten the terminal screw may cause overheating and fire.

Single Board Mounting

UP series miniature pilot light single board mounting types can be mounted with LB/ LBW series on the same panel. Follow the instructions below on single board mounting.

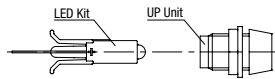

1. Mount the LED kit to the PC board.

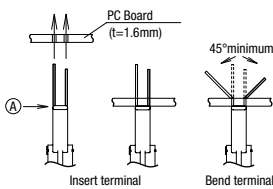

Temporary mounting

1. Note the polarity of the terminals and insert the terminals to the PC board.
2. Make sure that part A of the LED kit is pressed tightly to the PC board. Bend the terminals sideways as shown on the left.

2. Mount the operator and the UP series pilot lights on to the control panel.

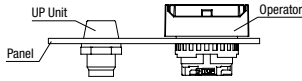

3. Mount the contact block to the operator of the miniature control unit and lock the unit by turning the locking lever.

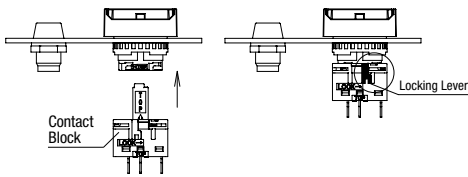

4. Install the PC board in 1. to the panel in 3.

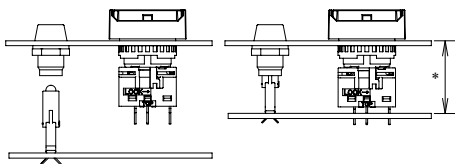

Note: Make sure that the LED kit is inserted into the UP series unit.

* When mounting LB/LBW and UP series on a single board, make sure that the distance between the front of the panel and the mounting side of the PC board (gasket distortion is taken into consideration) is as shown in the table below.

Part No.	Mountable Unit	Distance (*)
UP8-89V1*	Standard bezel	22.5mm
UP8-89V2*	Flush bezel	29.9mm
UP9P-99V1*	Standard bezel	22.5mm
	Flush bezel	29.9mm

5. Solder the terminals. Before soldering, make sure that each terminal of the contact block is securely inserted into the PC board holes.

Instructions

Polarity

Pay attention to the polarity of the power supply as UP series units do not contain a diode for protection against reverse polarity. The long terminal is positive and the short terminal is negative.

Current Limiting Resistor

When using a UP series unit without a built-in current limiting resistor, connect an external current limiting resistor. Calculate the resistance using the following formula.

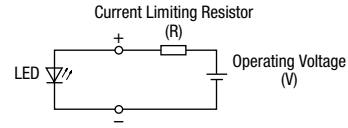

$$\text{Resistance } (\Omega) = \frac{\text{Operating Voltage (V)} - \text{Forward Voltage (Vf)}}{\text{Rated Current (I) *}}$$

- * Rated Current (I) = R (red), W (white) : 0.007A
G (green) : 0.002A
- Forward Voltage (Vf) = R (red), W (white) : 2V
G (green) : 2.7V

Note: Use a resistor of higher resistance than the calculated value (Ω)

$$\text{Rated Wattage of Resistor (W)} = \text{Rated Current (I)} \times \text{Operating Voltage (V)} \times 2 \text{ to } 3 *$$

* 2 to 3 is a safety factor

<Current Limiting Resistor Reference Value>

Operating Voltage	Color	
	Red (R), White (W)	Green (G)
5V DC	430Ω (1/4W)	1200Ω (1/4W)
6V DC	560Ω (1/4W)	1600Ω (1/4W)
12V DC	1500Ω (1/4W)	4700Ω (1/4W)
24V DC	3000Ω (1/2W)	11000Ω (1/4W)

Wiring

Solder the terminal at 350°C within 3 seconds using a 60W soldering iron. SnAgCu type lead-free solder is recommended. When soldering, do not touch the pilot light housing with the terminal. Do not bend the terminal or apply excessive force to the terminal.

Notes on Panel Mounting

Tightening torque should not exceed 0.49 N·m. Do not use pliers. Do not tighten with excessive force, otherwise the locking ring will be damaged.

PC Board and Circuit Design

Use glass epoxy copper clad laminate, double-sided through-hole PC boards with a thickness of 1.6 mm.

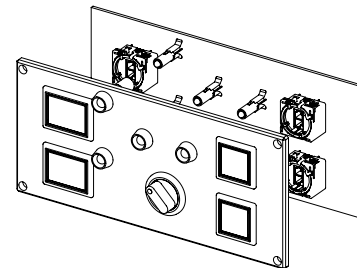

Example of single board mounting