

TYPICAL INDICATOR ORDERING EXAMPLE

LB 01 G W01 — 5C 12 — JC

Shapes

01	Square
02	Round
03	Rectangular

Housing

K	Black
G	Gray

Terminals

W01	Silver Solder Lug/ Quick Connect Terminals*
-----	---

Lamps

Incandescent Lamp Used with Solid Cap

05	5-volt
12	12-volt

Incandescent or Neon Used with Insert Cap

01	110-volt Neon
05	5-volt Incandescent
12	12-volt Incandescent

Bright LED Used with LED Cap

Colors		Resistor	
5C	Red	No Code	No Resistor
5D	Amber	05	5-volt
		12	12-volt
5F	Green	24	24-volt

Super Bright LED Used with LED Cap

6B	White
6F	Green
6G	Blue

Cap Types & Colors

Solid Cap: Lens/Filter Colors

BJ	White/Clear
CJ	Red/Clear
EJ	Yellow/Clear
FJ	Green/Clear
GJ	Blue/Clear

Insert Cap: Lens/Filter Colors

JB	Clear/White
JC	Clear/Red
JE	Clear/Yellow
*JF	Clear/Green
*JG	Clear/Blue

*JF & JG not suitable with neon.

LED Cap: Lens/Diffuser Colors

JB	Clear/White
JC	Clear/Red
JD	Clear/Amber
JF	Clear/Green

LED Cap: Lens/Diffuser Colors

JB	Clear/White
----	-------------

* Wire harness & cable assemblies offered only in Americas

DESCRIPTION FOR TYPICAL ORDERING EXAMPLE

LB01GW01-5C12-JC

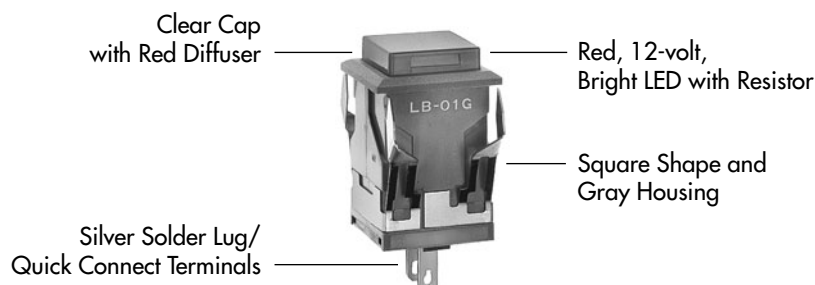

SHAPES & PANEL CUTOUTS

01 .622" (15.8mm)
Square

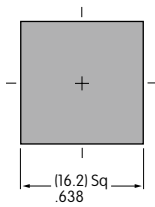
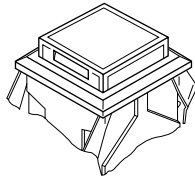

02 .854" (21.7mm)
Round

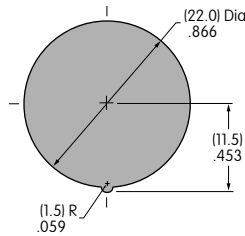
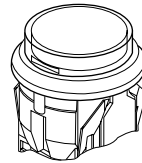

03 .622" x .866" (15.8mm x 22.0mm)
Rectangular

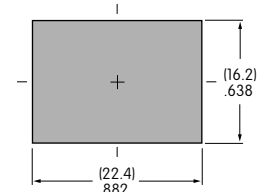

Panel Thickness: .039" ~ .157" (1.0 ~ 4.0mm)

HOUSING

Housing Colors Available:



Black



Gray

TERMINALS

W01 Silver Solder Lug / .110" (2.8mm) Quick Connect

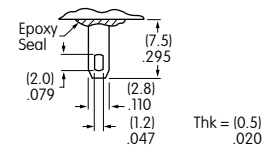

LAMP CODES & SPECIFICATIONS

Incandescent Lamp for Solid Colored and Colored Insert Caps

AT607  T-1 Bi-pin		05	12	
	Voltage	V	5V AC	12V AC
	Current	I	115mA	60mA
	Endurance	Hours	10,000 average	
	Ambient Temp. Range		-25°C ~ +50°C	

Neon Lamp for Colored Insert Cap

AT607N  T-1 Bi-pin		01	
	Voltage	V	110V AC
	Current	I	1.5mA
	Endurance	Hours	10,000 average
	Ambient Temp. Range		-25°C ~ +50°C
Recommended Resistors: 33K ohms for 110V AC; 100K ohms for 220V AC			

The electrical specifications shown are determined at a basic temperature of 25°C.

LED COLORS & SPECIFICATIONS

The electrical specifications shown are determined at a basic temperature of 25°C. Polarity marks are on the device.
 If the source voltage exceeds the rated voltage, a ballast resistor is required.
 The resistor value can be calculated by using the formula in the Supplement section.
 Additional lamp detail is shown in the Accessories & Hardware section.

Bright LED without Resistor

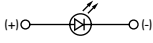
AT635 LEDs are colored in OFF state.   T-1½ Bi-pin	Color Codes	Red 5C	Amber 5D	Green 5F	No Code No Resistor
	Forward Peak Current	I_{FM}			30mA
	Typical Forward Current	I_F			20mA
	Forward Voltage	V_F			1.9V
	Reverse Peak Voltage	V_{RM}			5V
	Current Reduction Rate Above 25°C	ΔI_F			0.42mA/°C
	Ambient Temperature Range				-25° ~ +50°C

Bright LED with Resistor

AT627 with Resistor  T-1 Bi-pin	Color Codes:	Red 5C	Amber 5D	Green 5F	Resistor Codes		
	Forward Peak Current	I_{FM}			05	12	24
	Typical Forward Current	I_F			52mA	26mA	13mA
	Forward Voltage	V_F			5V	12V	24V
	Reverse Peak Voltage	V_{RM}			4V	8V	16V
	Current Reduction Rate Above 25°C	ΔI_F			0.50mA/°C		
	Ambient Temperature Range				-25° ~ +50°C		

AT627
5-volt
4-element
with Resistor

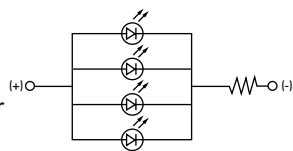

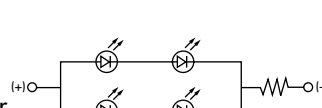

AT627
12-volt
4-element
with Resistor

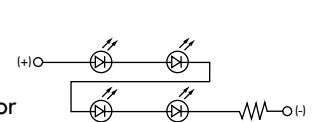

AT627
24-volt
4-element
with Resistor



Super Bright Single Element LED

AT625G Blue AT631B White AT632F Green   T-1 Bi-pin				6B	6F	6G	
	Color	White	Green	Blue			
	Forward Peak Current	I_{FM}			30mA	30mA	30mA
	Typical Forward Current	I_F			20mA	20mA	20mA
	Forward Voltage	V_F			3.6V	3.5V	3.6V
	Reverse Peak Voltage	V_{RM}			5V	5V	5V
	Current Reduction Rate Above 25°C	ΔI_F			0.50mA/°C		
Ambient Temperature Range				-25° ~ +50°C			

Toggles
 Rockers
 Pushbuttons
 Illuminated PB
 Programmable
 Keylocks
 Rotaries
 Slides
 Tactiles
 Tilt
 Touch
 Indicators
 Accessories
 Supplement

CAP TYPES & COLOR COMBINATIONS

Color Codes: B White C Red D Amber E Yellow F Green G Blue J Clear

Solid Cap for Incandescent Lamp

Lens/Filter
Colors Available:

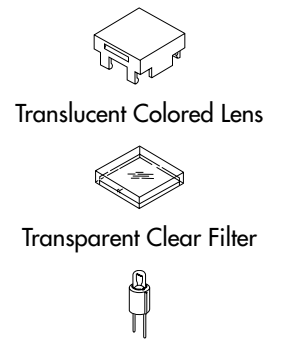
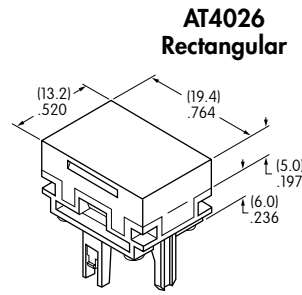
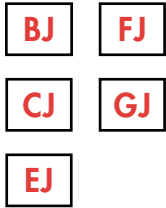

Material: Polycarbonate Finish: Glossy

Lamp AT607

Insert Cap for Incandescent or Neon Lamp

Lens/Filter
Colors Available:

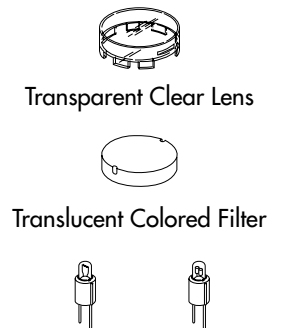
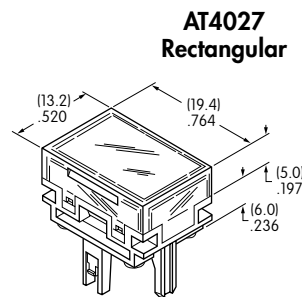
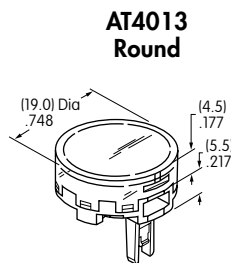
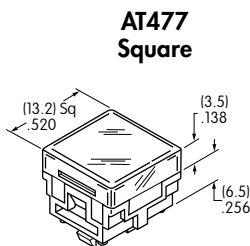
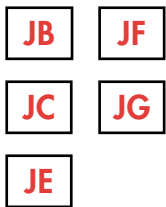

JF and JG not suitable with neon lamp.

Material: Polycarbonate Finish: Glossy

Lamp AT607 or 607N

Cap for Bright LED without Resistor

Lens/Diffuser
Colors Available:

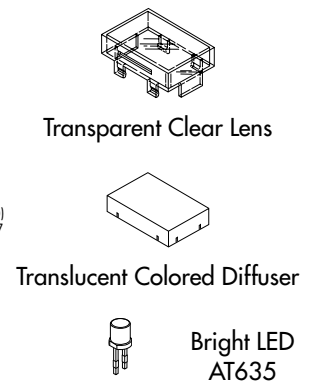
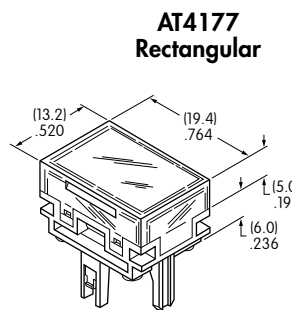
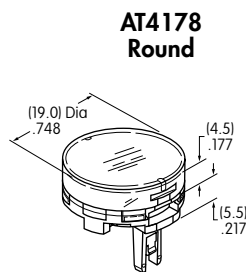
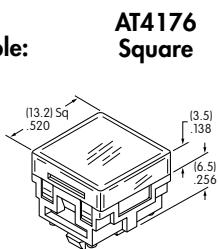

Material: Polycarbonate Finish: Glossy

Bright LED AT635

Cap for Bright LED with Resistor

Lens/Diffuser
Colors Available:

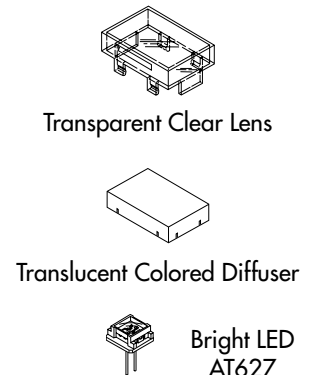
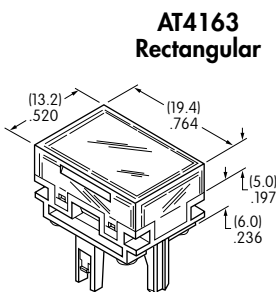
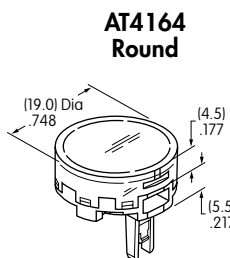
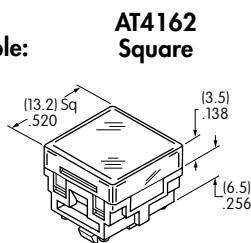

Material: Polycarbonate Finish: Glossy

Bright LED AT627

CAP TYPES & COLOR COMBINATIONS

Cap for Super Bright LEDs



Clear Lens
White Diffuser

AT4129
Square

AT4128
Round

AT4130
Rectangular



Transparent
Clear Lens

Material:
Polycarbonate
Finish: Glossy

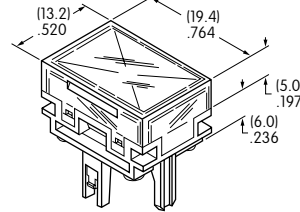
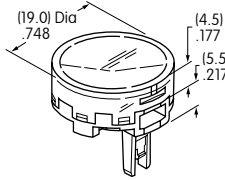
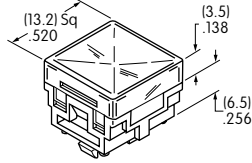

Translucent
White Diffuser



LEDs AT625
AT631 AT632

TYPICAL INDICATOR DIMENSIONS

Square

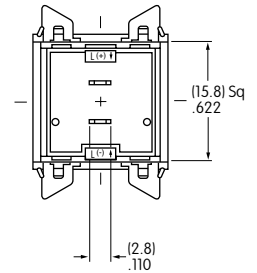
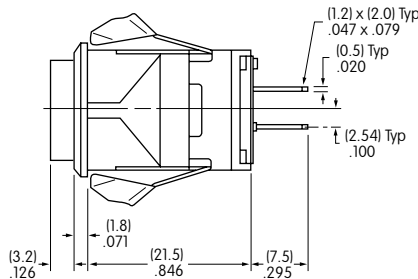
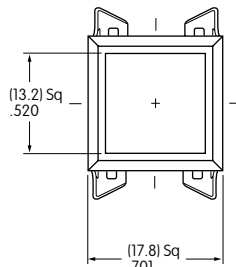

LB01KW01-12-CJ

Round

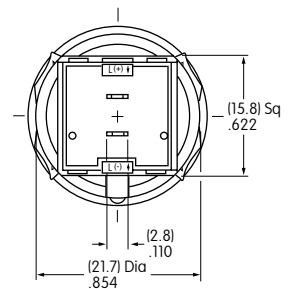
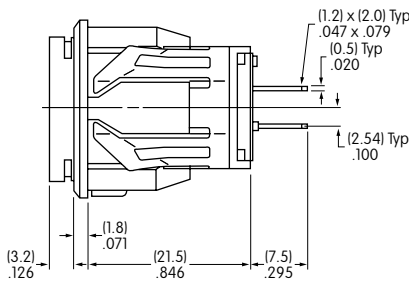
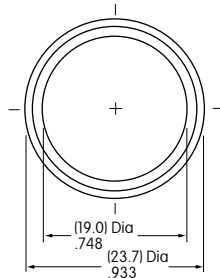

LB02KW01-12-CJ

Rectangular

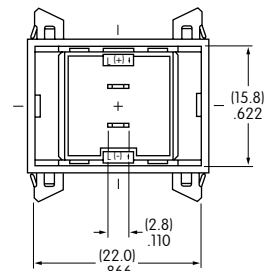
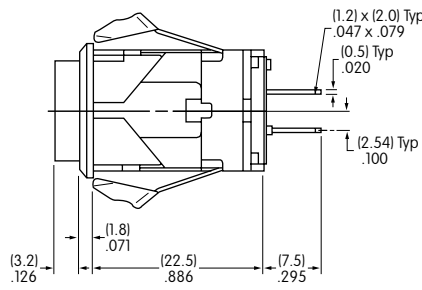
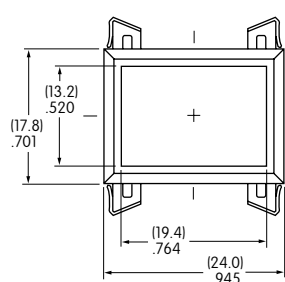

LB03KW01-12-CJ