

ø16

L6 Series Miniature Control Units

Light duty L6 series

Suitable for electronic devices and for food processing and packaging industries.

- Locking lever removable contact blocks
- Bright and clear LED illumination
- Gold-clad cross bar contacts and silver contacts
- Degree of protection: IP65 (IEC 60529) (except buzzers)
- UL recognized and CSA certified (except buzzers)
- EN compliant (except buzzers) (EN60947-1, EN60947-5-1, TÜV Rheinland)
- RoHS compliant



Specifications and Ratings

Contact Ratings

• Gold Contact

Maximum Voltage	250V AC/DC	
Thermal Current	3A	
Operating Voltage	125V AC	30V DC
Operating Current (resistive load)	0.1A	0.1A
Contact Material	Gold-clad silver	

Minimum applicable load (reference value): 5V AC/DC, 1 mA
(Applicable range is subject to the operating condition and load.)

• Silver Contact

Insulation Voltage		250V			
Operating Voltage		30V	125V	250V	
Operating Current	AC 50/60Hz	Resistive Load	—	5A	2A
		Inductive Load	—	2A	1.5A
	DC	Resistive Load	3A	0.4A	—
		Inductive Load	1A	0.2A	—
Thermal Current		5A			
Contact Material		Silver			

AC inductive load: PF = 0.6 to 0.7

DC inductive load: L/R = 7 ms maximum







Built-in LED Lamp Ratings

Type No.	LFTD-5②	LFTD-1②	LFTD-2②
Lamp Base	SX6S/8x5.4		
Rated Voltage	5V DC	12V AC/DC	24V AC/DC
Operating Voltage	5V DC ±5%	12V AC/DC ±10%	24V AC/DC ±10%
Current Draw	AC	—	9 mA
	DC	8 mA	8 mA
Color Code ②	Specify a color code in place of ② in the Type No. A (amber), G (green), R (red), S (blue), W (white), Y (yellow)		
Lamp Base Color	Same as illumination color		
Voltage Marking	Die stamped on the lamp base		
Life (reference value)	Approx. 50,000 hours (When used on complete DC, luminance reduces to 50% of the initial intensity.)		
Internal Circuit	A, R, W, Y	A, R, W, Y	
	G, S	G, S	
		LED Chip Protection Diode Zener Diode	

Specifications

Operating Temperature	-25 to +55°C (no freezing)	
Storage Temperature	-30 to +80°C	
Operating Humidity	45 to 85% RH (no condensation)	
Contact Resistance	50 mΩ maximum (initial value)	
Insulation Resistance	100 MΩ minimum (500V DC megger)	
Dielectric Strength	Switch Unit	Between live part and ground: 2,500V AC, 1 minute Between terminals of different poles: 2,500V AC, 1 minute Between terminals of the same poles: 1,000V AC, 1 minute
	Illumination Unit	Between live part and ground: 2,500V AC, 1 minute
Vibration Resistance	Operating extremes: 5 to 55 Hz, amplitude 0.5 mm	
Shock Resistance	Damage limits: 1,000 m/s ² (100G) Operating extremes: 100 m/s ² (10G)	
Mechanical Durability (minimum operations)	Momentary:	2,000,000
	Maintained:	250,000
	Lever switches:	250,000
	Selector switches:	250,000
	Key selector switches:	250,000
Electrical Durability (minimum operations)	Momentary:	100,000 (*1, *3)
	Maintained:	100,000 (*2, *3)
	Lever switches:	100,000 (*2, *3)
	Selector switches:	100,000 (*2, *3)
	Key selector switches:	100,000 (*2, *3)
Degree of Protection	IP65 (IEC 60529)	
	Terminal Style	
	Solder/tab terminal #110 PC board terminal	
Weight (approx.)	17g (LA1L-M1C24)	
	15g (LA1P-1C04)	
	13g (LA1B-M1C2)	
	15g (LA1T-2C2)	
	15g (LA1S-2C2)	
	27g (LA1K-2C2A)	
18g (LA1F-2C24)		



LA1L / LA2L Illuminated Pushbuttons

Shape	Operation Type	Contact Material	Operating Voltage	Contact	Type No.		② Lens Color Code	
					Solder/Tab Terminal	PC Board Terminal		
Round LA1L  RUL  	Momentary	Gold	5V DC ±5%	SPDT	LA1L-M1C11②	LA1L-M1C11V②	Specify a lens color code in place of ② in the Type No. A: amber G: green R: red W: white S: blue Y: yellow	
			12V AC/DC ±10%	DPDT	LA1L-M1C21②	LA1L-M1C21V②		
			24V AC/DC ±10%	SPDT	LA1L-M1C13②	LA1L-M1C13V②		
				DPDT	LA1L-M1C23②	LA1L-M1C23V②		
		5V DC ±5%	Silver	SPDT	LA1L-M1C14②	LA1L-M1C14V②		
				DPDT	LA1L-M1C24②	LA1L-M1C24V②		
		12V AC/DC ±10%		SPDT	LA1L-M1C51②	—		
				DPDT	LA1L-M1C61②	—		
		24V AC/DC ±10%	SPDT	LA1L-M1C53②	—			
				LA1L-M1C63②	—			
		5V DC ±5%	Gold	SPDT	LA1L-A1C11②	LA1L-A1C11V②		
				DPDT	LA1L-A1C21②	LA1L-A1C21V②		
	12V AC/DC ±10%	SPDT		LA1L-A1C13②	LA1L-A1C13V②			
		DPDT		LA1L-A1C23②	LA1L-A1C23V②			
	24V AC/DC ±10%	SPDT	LA1L-A1C14②	LA1L-A1C14V②				
			LA1L-A1C24②	LA1L-A1C24V②				
	5V DC ±5%	Silver	SPDT	LA1L-A1C51②	—			
			DPDT	LA1L-A1C61②	—			
	12V AC/DC ±10%		SPDT	LA1L-A1C53②	—			
			DPDT	LA1L-A1C63②	—			
	24V AC/DC ±10%	SPDT	LA1L-A1C54②	—				
			LA1L-A1C64②	—				
	Square LA2L  RUL  	Momentary	Gold	5V DC ±5%	SPDT	LA2L-M1C11②		LA2L-M1C11V②
				12V AC/DC ±10%	DPDT	LA2L-M1C21②		LA2L-M1C21V②
24V AC/DC ±10%				SPDT	LA2L-M1C13②	LA2L-M1C13V②		
				DPDT	LA2L-M1C23②	LA2L-M1C23V②		
5V DC ±5%			Silver	SPDT	LA2L-M1C14②	LA2L-M1C14V②		
				DPDT	LA2L-M1C24②	LA2L-M1C24V②		
12V AC/DC ±10%				SPDT	LA2L-M1C51②	—		
				DPDT	LA2L-M1C61②	—		
24V AC/DC ±10%			SPDT	LA2L-M1C53②	—			
				LA2L-M1C63②	—			
5V DC ±5%			Gold	SPDT	LA2L-A1C11②	LA2L-A1C11V②		
				DPDT	LA2L-A1C21②	LA2L-A1C21V②		
12V AC/DC ±10%		SPDT		LA2L-A1C13②	LA2L-A1C13V②			
		DPDT		LA2L-A1C23②	LA2L-A1C23V②			
24V AC/DC ±10%		SPDT	LA2L-A1C14②	LA2L-A1C14V②				
			LA2L-A1C24②	LA2L-A1C24V②				
5V DC ±5%		Silver	SPDT	LA2L-A1C51②	—			
			DPDT	LA2L-A1C61②	—			
12V AC/DC ±10%			SPDT	LA2L-A1C53②	—			
			DPDT	LA2L-A1C63②	—			
24V AC/DC ±10%		SPDT	LA2L-A1C54②	—				
			LA2L-A1C64②	—				

L-shaped lever contact types are also available for collective mounting.
 To order L-shaped lever contacts, specify "T" in place of "C" in the Type No.

Example: (Standard contact type) LA1L-M1C11② (L-shaped lever contact type) LA1L-M1T11②









LA3L / LA4L Illuminated Pushbuttons

Shape	Operation Type	Contact Material	Operating Voltage	Contact	Type No.		② Lens Color Code	
					Solder/Tab Terminal	PC Board Terminal		
Rectangular LA3L  RU SF A CE	Momentary	Gold	5V DC ±5%	SPDT	LA3L-M1C11②	LA3L-M1C11V②	Specify a lens color code in place of ② in the Type No. A: amber G: green R: red W: white S: blue Y: yellow	
				DPDT	LA3L-M1C21②	LA3L-M1C21V②		
			12V AC/DC ±10%	SPDT	LA3L-M1C13②	LA3L-M1C13V②		
				DPDT	LA3L-M1C23②	LA3L-M1C23V②		
			24V AC/DC ±10%	SPDT	LA3L-M1C14②	LA3L-M1C14V②		
				DPDT	LA3L-M1C24②	LA3L-M1C24V②		
		DPDT	LA3L-M1C61②	—				
		12V AC/DC ±10%	SPDT	LA3L-M1C53②	—			
			DPDT	LA3L-M1C63②	—			
		24V AC/DC ±10%	SPDT	LA3L-M1C54②	—			
			DPDT	LA3L-M1C64②	—			
		Maintained	Gold	5V DC ±5%	SPDT	LA3L-A1C11②		LA3L-A1C11V②
	DPDT				LA3L-A1C21②	LA3L-A1C21V②		
	12V AC/DC ±10%			SPDT	LA3L-A1C13②	LA3L-A1C13V②		
				DPDT	LA3L-A1C23②	LA3L-A1C23V②		
	24V AC/DC ±10%			SPDT	LA3L-A1C14②	LA3L-A1C14V②		
				DPDT	LA3L-A1C24②	LA3L-A1C24V②		
	DPDT		LA3L-A1C61②	—				
	12V AC/DC ±10%		SPDT	LA3L-A1C53②	—			
			DPDT	LA3L-A1C63②	—			
	24V AC/DC ±10%		SPDT	LA3L-A1C54②	—			
			DPDT	LA3L-A1C64②	—			
	Rectangular 3-sided Barrier LA4L  RU SF A CE		Momentary	Gold	5V DC ±5%	SPDT		LA4L-M1C11②
		DPDT				LA4L-M1C21②		LA4L-M1C21V②
12V AC/DC ±10%		SPDT			LA4L-M1C13②	LA4L-M1C13V②		
		DPDT			LA4L-M1C23②	LA4L-M1C23V②		
24V AC/DC ±10%		SPDT			LA4L-M1C14②	LA4L-M1C14V②		
		DPDT			LA4L-M1C24②	LA4L-M1C24V②		
DPDT		LA4L-M1C61②		—				
12V AC/DC ±10%		SPDT		LA4L-M1C53②	—			
		DPDT		LA4L-M1C63②	—			
24V AC/DC ±10%		SPDT		LA4L-M1C54②	—			
		DPDT		LA4L-M1C64②	—			
Maintained		Gold		5V DC ±5%	SPDT	LA4L-A1C11②	LA4L-A1C11V②	
			DPDT		LA4L-A1C21②	LA4L-A1C21V②		
			12V AC/DC ±10%	SPDT	LA4L-A1C13②	LA4L-A1C13V②		
				DPDT	LA4L-A1C23②	LA4L-A1C23V②		
			24V AC/DC ±10%	SPDT	LA4L-A1C14②	LA4L-A1C14V②		
				DPDT	LA4L-A1C24②	LA4L-A1C24V②		
		DPDT	LA4L-A1C61②	—				
		12V AC/DC ±10%	SPDT	LA4L-A1C53②	—			
			DPDT	LA4L-A1C63②	—			
		24V AC/DC ±10%	SPDT	LA4L-A1C54②	—			
			DPDT	LA4L-A1C64②	—			

L-shaped lever contact types are also available for collective mounting.
 To order L-shaped lever contact types, specify "T" in place of "C" in the Type No.

Example: (Standard contact type) LA3L-M1C11② (L-shaped lever contact type) LA3L-M1T11②

LA□P Pilot Lights



Shape	Operating Voltage	Type No.		② Lens Color Code
		Solder/Tab Terminal	PC Board Terminal	
Round LA1P  	5V DC ±5%	LA1P-1C01②	LA1P-1C01V②	Specify a lens color code in place of ② in the Type No. A: amber G: green R: red W: white S: blue Y: yellow
	12V AC/DC ±10%	LA1P-1C03②	LA1P-1C03V②	
	24V AC/DC ±10%	LA1P-1C04②	LA1P-1C04V②	
Square LA2P  	5V DC ±5%	LA2P-1C01②	LA2P-1C01V②	
	12V AC/DC ±10%	LA2P-1C03②	LA2P-1C03V②	
	24V AC/DC ±10%	LA2P-1C04②	LA2P-1C04V②	
Rectangular LA3P  	5V DC ±5%	LA3P-1C01②	LA3P-1C01V②	
	12V AC/DC ±10%	LA3P-1C03②	LA3P-1C03V②	
	24V AC/DC ±10%	LA3P-1C04②	LA3P-1C04V②	
Rectangular 3-sided Barrier LA4P  	5V DC ±5%	LA4P-1C01②	LA4P-1C01V②	
	12V AC/DC ±10%	LA4P-1C03②	LA4P-1C03V②	
	24V AC/DC ±10%	LA4P-1C04②	LA4P-1C04V②	

L-shaped lever contact types are also available for collective mounting.
 To order L-shaped lever contact types, specify "T" in place of "C" in the Type No.

Example: (Standard contact type) (L-shaped lever contact type)
 LA1P-1C01② LA1P-1T01②

ø16 L6 Series Miniature Control Units



LA1B / LA2B Pushbuttons

Shape	Button Type	Operation Type	Contact Material	Contact	Type No.		Color Code ^{①②}	
					Solder/Tab Terminal	PC Board Terminal		
Round LA1B  RU SB Δ CE	Button	Momentary	Gold	SPDT	LA1B-M1C1 ^①	LA1B-M1C1V ^①	B: black G: green R: red S: blue W: white Y: yellow	
			Silver	DPDT	LA1B-M1C2 ^①	LA1B-M1C2V ^①		
		Maintained	Gold	SPDT	LA1B-M1C5 ^①	—		
			Silver	DPDT	LA1B-M1C6 ^①	—		
		Illumination Lens	Momentary	Gold	SPDT	LA1B-A1C1 ^①		LA1B-A1C1V ^①
				Silver	DPDT	LA1B-A1C2 ^①		LA1B-A1C2V ^①
	Maintained		Gold	SPDT	LA1B-A1C5 ^①	—		
			Silver	DPDT	LA1B-A1C6 ^①	—		
	Momentary		Gold	SPDT	LA1B-M1C1L ^②	LA1B-M1C1VL ^②	A: amber G: green R: red S: blue W: white Y: yellow	
			Silver	DPDT	LA1B-M1C2L ^②	LA1B-M1C2VL ^②		
		Maintained	Gold	SPDT	LA1B-A1C1L ^②	LA1B-A1C1VL ^②		
			Silver	DPDT	LA1B-A1C2L ^②	LA1B-A1C2VL ^②		
Square LA2B  RU SB Δ CE	Button	Momentary	Gold	SPDT	LA2B-M1C1 ^①	LA2B-M1C1V ^①	B: black G: green R: red S: blue W: white Y: yellow	
			Silver	DPDT	LA2B-M1C2 ^①	LA2B-M1C2V ^①		
		Maintained	Gold	SPDT	LA2B-M1C5 ^①	—		
			Silver	DPDT	LA2B-M1C6 ^①	—		
		Illumination Lens	Momentary	Gold	SPDT	LA2B-A1C1 ^①		LA2B-A1C1V ^①
				Silver	DPDT	LA2B-A1C2 ^①		LA2B-A1C2V ^①
	Maintained		Gold	SPDT	LA2B-A1C5 ^①	—		
			Silver	DPDT	LA2B-A1C6 ^①	—		
	Momentary		Gold	SPDT	LA2B-M1C1L ^②	LA2B-M1C1VL ^②	A: amber G: green R: red S: blue W: white Y: yellow	
			Silver	DPDT	LA2B-M1C2L ^②	LA2B-M1C2VL ^②		
		Maintained	Gold	SPDT	LA2B-A1C1L ^②	LA2B-A1C1VL ^②		
			Silver	DPDT	LA2B-A1C2L ^②	LA2B-A1C2VL ^②		

L-shaped lever contact types are also available for collective mounting.
 To order L-shaped lever contact types, specify "T" in place of "C" in the Type No.

Example: (Standard contact type) LA1B-M1C1^① (L-shaped lever contact type) LA1B-M1T1^①

LA1T Lever Switches

Shape	Lever Operation	Contact Material	Contact	Type No.		
				Solder/Tab Terminal	PC Board Terminal	
Round LA1T  	2-position	Maintained	Gold	SPDT	LA1T-2C1	LA1T-2C1V
				DPDT	LA1T-2C2	LA1T-2C2V
			Silver	SPDT	LA1T-2C5	—
		DPDT		LA1T-2C6	—	
		Spring return from top	Gold	SPDT	LA1T-21C1	LA1T-21C1V
				DPDT	LA1T-21C2	LA1T-21C2V
	Silver		SPDT	LA1T-21C5	—	
		DPDT	LA1T-21C6	—		
	Spring return from bottom	Gold	SPDT	LA1T-22C1	LA1T-22C1V	
			DPDT	LA1T-22C2	LA1T-22C2V	
		Silver	SPDT	LA1T-22C5	—	
	DPDT		LA1T-22C6	—		
	3-position	Maintained	Gold	DPDT	LA1T-3C2	LA1T-3C2V
				Silver	DPDT	LA1T-3C6
		Spring return from top	Gold	DPDT	LA1T-31C2	LA1T-31C2V
				Silver	DPDT	LA1T-31C6
Spring return from bottom		Gold	DPDT	LA1T-32C2	LA1T-32C2V	
			Silver	DPDT	LA1T-32C6	—
Spring return two-way	Gold	DPDT	LA1T-33C2	LA1T-33C2V		
		Silver	DPDT	LA1T-33C6	—	

L-shaped lever contact types are also available for collective mounting.
 To order L-shaped lever contact types, specify "T" in place of "C" in the Type No.

Example: (Standard contact type) LA1T-2C1 (L-shaped lever contact type) LA1T-2T1

Contact Operation

	Contact	Operator Position & Contact Operation (Top View)		
		Down	Center	Up
90° 2-position Maintained Spring return from top	SPDT		—	
	DPDT		—	
90° 2-position Spring return from bottom	SPDT		—	
	DPDT		—	
45° 3-position	DPDT			

Dimensions

Pilot Lights

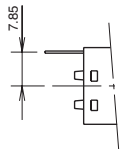

Pushbuttons

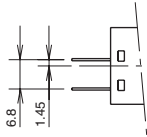

Illuminated Pushbuttons

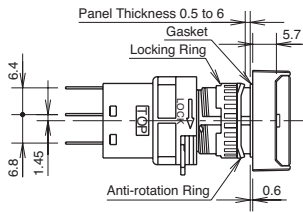

Note:

1. Pushbuttons do not have lamp terminals.
2. Pilot lights have only lamp terminals.
3. See page 26 for L-shaped lever contact types.

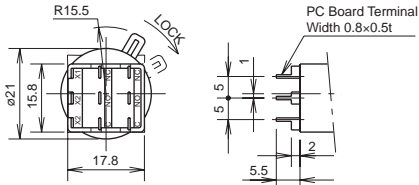

PC Board Terminal

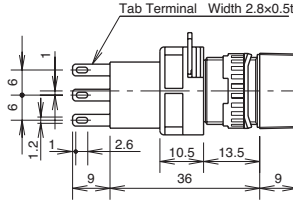

Solder/Tab Terminal

Round



Square



Rectangular

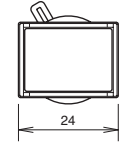

Rectangular 3-sided Barrier

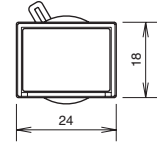

Lever Switches

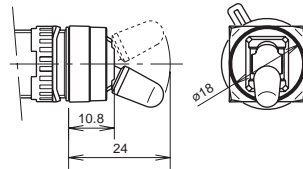

Mounting Hole Layout

Standard Contact Type

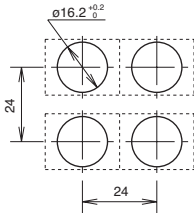

- Note: Determine mounting centers to ensure easy operation.
- See page 26 for L-shaped lever contact types.

Terminal Arrangement (Bottom View)

Illuminated Pushbuttons

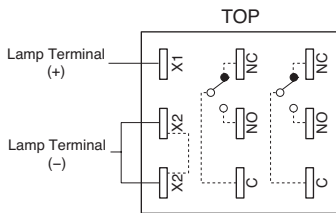

SPDT has C, NO, and NC only on the right. X2 terminals are interconnected.

Pilot Lights

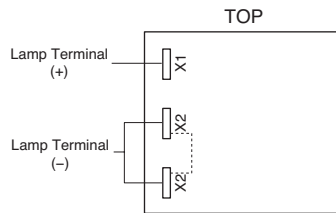

X2 terminals are interconnected.

Pushbuttons Lever Switches

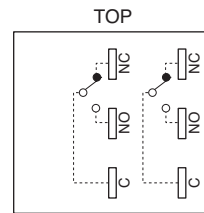

SPDT has C, NO, and NC only on the right.

PC Board Drilling Layout (Bottom View)

Illuminated Pushbuttons

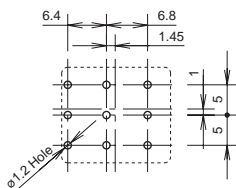

Pilot Lights

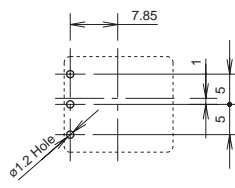

Pushbuttons Lever Switches

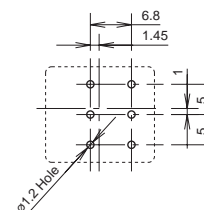







• See One Board Mounting on page 26 for details about PC boards.

All dimensions in mm.

ø16 L6 Series Miniature Control Units



















LA□S Selector Switches

Shape	Position		Contact Material	Contact	Type No.		
					Solder/Tab Terminal	PC Board Terminal	
Round LA1S  	90° 2-position	Maintained	L R	Gold	SPDT	LA1S-2C1	LA1S-2C1V
				Silver	DPDT	LA1S-2C2	LA1S-2C2V
			Gold	SPDT	LA1S-2C5	—	
		Spring return from right	L R	Silver	DPDT	LA1S-2C6	—
				Gold	SPDT	LA1S-21C1	LA1S-21C1V
			Silver	DPDT	LA1S-21C2	LA1S-21C2V	
	45° 3-position	Maintained	L C R	Gold	SPDT	LA1S-3C2	LA1S-3C2V
				Silver	DPDT	LA1S-3C6	—
		Spring return from right	L C R	Gold	DPDT	LA1S-31C2	LA1S-31C2V
				Silver	DPDT	LA1S-31C6	—
		Spring return from left	L C R	Gold	DPDT	LA1S-32C2	LA1S-32C2V
				Silver	DPDT	LA1S-32C6	—
		Spring return two-way	L C R	Gold	DPDT	LA1S-33C2	LA1S-33C2V
				Silver	DPDT	LA1S-33C6	—
Square LA2S  	90° 2-position	Maintained	L R	Gold	SPDT	LA2S-2C1	LA2S-2C1V
				Silver	DPDT	LA2S-2C2	LA2S-2C2V
			Gold	SPDT	LA2S-2C5	—	
		Spring return from right	L R	Silver	DPDT	LA2S-2C6	—
				Gold	SPDT	LA2S-21C1	LA2S-21C1V
			Silver	DPDT	LA2S-21C2	LA2S-21C2V	
	45° 3-position	Maintained	L C R	Gold	SPDT	LA2S-3C2	LA2S-3C2V
				Silver	DPDT	LA2S-3C6	—
		Spring return from right	L C R	Gold	DPDT	LA2S-31C2	LA2S-31C2V
				Silver	DPDT	LA2S-31C6	—
		Spring return from left	L C R	Gold	DPDT	LA2S-32C2	LA2S-32C2V
				Silver	DPDT	LA2S-32C6	—
		Spring return two-way	L C R	Gold	DPDT	LA2S-33C2	LA2S-33C2V
				Silver	DPDT	LA2S-33C6	—
Rectangular LA3S  	90° 2-position	Maintained	L R	Gold	SPDT	LA3S-2C1	LA3S-2C1V
				Silver	DPDT	LA3S-2C2	LA3S-2C2V
			Gold	SPDT	LA3S-2C5	—	
		Spring return from right	L R	Silver	DPDT	LA3S-2C6	—
				Gold	SPDT	LA3S-21C1	LA3S-21C1V
			Silver	DPDT	LA3S-21C2	LA3S-21C2V	
	45° 3-position	Maintained	L C R	Gold	SPDT	LA3S-3C2	LA3S-3C2V
				Silver	DPDT	LA3S-3C6	—
		Spring return from right	L C R	Gold	DPDT	LA3S-31C2	LA3S-31C2V
				Silver	DPDT	LA3S-31C6	—
		Spring return from left	L C R	Gold	DPDT	LA3S-32C2	LA3S-32C2V
				Silver	DPDT	LA3S-32C6	—
		Spring return two-way	L C R	Gold	DPDT	LA3S-33C2	LA3S-33C2V
				Silver	DPDT	LA3S-33C6	—

- For contact operation, see page 19.
- L-shaped lever contact types are also available for collective mounting.
To order L-shaped contact types, specify "T" in place of "C" in the Type No.

Example: (Standard contact type) LA1S-2C1 (L-shaped lever contact type) LA1S-2T1

LA1K Key Selector Switches



















Shape	Position		Key Retained at ●	Contact Material	Contact	Type No.		
						Solder/Tab Terminal	PC Board Terminal	
Round LA1K  RA SP Δ CE	90° 2-position	Maintained	A 	Gold	SPDT	LA1K-2C1A	LA1K-2C1VA	
				DPDT	LA1K-2C2A	LA1K-2C2VA		
			Silver	SPDT	LA1K-2C5A	—		
				DPDT	LA1K-2C6A	—		
			B 	Gold	SPDT	LA1K-2C1B	LA1K-2C1VB	
				DPDT	LA1K-2C2B	LA1K-2C2VB		
		Silver	SPDT	LA1K-2C5B	—			
			DPDT	LA1K-2C6B	—			
		C 	Gold	SPDT	LA1K-2C1C	LA1K-2C1VC		
				DPDT	LA1K-2C2C	LA1K-2C2VC		
			Silver	SPDT	LA1K-2C5C	—		
				DPDT	LA1K-2C6C	—		
	Spring return from right		B 	Silver	SPDT	LA1K-21C1B	LA1K-21C1VB	
				DPDT	LA1K-21C2B	LA1K-21C2VB		
		Gold	SPDT	LA1K-21C5B	—			
			DPDT	LA1K-21C6B	—			
		45° 3-position	Maintained	A 	Gold	DPDT	LA1K-3C2A	LA1K-3C2VA
					Silver	DPDT	LA1K-3C6A	—
	B 			Gold	DPDT	LA1K-3C2B	LA1K-3C2VB	
				Silver	DPDT	LA1K-3C6B	—	
	C 			Gold	DPDT	LA1K-3C2C	LA1K-3C2VC	
				Silver	DPDT	LA1K-3C6C	—	
	D 			Gold	DPDT	LA1K-3C2D	LA1K-3C2VD	
				Silver	DPDT	LA1K-3C6D	—	
	E 			Gold	DPDT	LA1K-3C2E	LA1K-3C2VE	
				Silver	DPDT	LA1K-3C6E	—	
	G 			Gold	DPDT	LA1K-3C2G	LA1K-3C2VG	
				Silver	DPDT	LA1K-3C6G	—	
	H 		Gold	DPDT	LA1K-3C2H	LA1K-3C2VH		
			Silver	DPDT	LA1K-3C6H	—		
Spring return from right	B 		Gold	DPDT	LA1K-31C2B	LA1K-31C2VB		
			Silver	DPDT	LA1K-31C6B	—		
	D 		Gold	DPDT	LA1K-31C2D	LA1K-31C2VD		
			Silver	DPDT	LA1K-31C6D	—		
	G 		Gold	DPDT	LA1K-31C2G	LA1K-31C2VG		
			Silver	DPDT	LA1K-31C6G	—		
Spring return from left	C 		Gold	DPDT	LA1K-32C2C	LA1K-32C2VC		
			Silver	DPDT	LA1K-32C6C	—		
	D 		Gold	DPDT	LA1K-32C2D	LA1K-32C2VD		
			Silver	DPDT	LA1K-32C6D	—		
	H 	Gold	DPDT	LA1K-32C2H	LA1K-32C2VH			
		Silver	DPDT	LA1K-32C6H	—			
Spring return two-way	D 	Gold	DPDT	LA1K-33C2D	LA1K-33C2VD			
		Silver	DPDT	LA1K-33C6D	—			

- For contact operation, see page 19.
- Two keys are supplied.
- L-shaped lever contact types are also available for collective mounting.
To order L-shaped lever contact types, specify "T" in place of "C" in the Type No.

Example: (Standard contact type) LA1K-2C1A (L-shaped lever contact type) LA1K-2T1A

ø16 L6 Series Miniature Control Units



















LA2K Key Selector Switches

Shape	Position	Key Retained at ●	Contact Material	Contact	Type No.						
					Solder/Tab Terminal	PC Board Terminal					
Square LA2K  UL SF Δ CE	90° 2-position	Maintained	A		Gold	SPDT	LA2K-2C1A	LA2K-2C1VA			
					DPDT	LA2K-2C2A	LA2K-2C2VA				
			Silver	SPDT	LA2K-2C5A	—					
				DPDT	LA2K-2C6A	—					
			B		Gold	SPDT	LA2K-2C1B	LA2K-2C1VB			
					DPDT	LA2K-2C2B	LA2K-2C2VB				
		Silver	SPDT	LA2K-2C5B	—						
			DPDT	LA2K-2C6B	—						
		C		Gold	SPDT	LA2K-2C1C	LA2K-2C1VC				
				DPDT	LA2K-2C2C	LA2K-2C2VC					
		Silver	SPDT	LA2K-2C5C	—						
			DPDT	LA2K-2C6C	—						
	Spring return from right	B		Silver	SPDT	LA2K-21C1B	LA2K-21C1VB				
					DPDT	LA2K-21C2B	LA2K-21C2VB				
				Gold	SPDT	LA2K-21C5B	—				
					DPDT	LA2K-21C6B	—				
				45° 3-position	Maintained	A		Gold	DPDT	LA2K-3C2A	LA2K-3C2VA
								Silver	DPDT	LA2K-3C6A	—
	B		Gold			DPDT	LA2K-3C2B	LA2K-3C2VB			
			Silver			DPDT	LA2K-3C6B	—			
	C		Gold			DPDT	LA2K-3C2C	LA2K-3C2VC			
			Silver			DPDT	LA2K-3C6C	—			
	D		Gold			DPDT	LA2K-3C2D	LA2K-3C2VD			
			Silver			DPDT	LA2K-3C6D	—			
	E		Gold			DPDT	LA2K-3C2E	LA2K-3C2VE			
			Silver			DPDT	LA2K-3C6E	—			
	G		Gold			DPDT	LA2K-3C2G	LA2K-3C2VG			
			Silver			DPDT	LA2K-3C6G	—			
	H		Gold	DPDT	LA2K-3C2H	LA2K-3C2VH					
			Silver	DPDT	LA2K-3C6H	—					
	Spring return from right	B		Gold	DPDT	LA2K-31C2B	LA2K-31C2VB				
					DPDT	LA2K-31C6B	—				
				Silver	DPDT	LA2K-31C2D	LA2K-31C2VD				
					DPDT	LA2K-31C6D	—				
				G		Gold	DPDT	LA2K-31C2G	LA2K-31C2VG		
						Silver	DPDT	LA2K-31C6G	—		
Spring return from left	C		Gold	DPDT	LA2K-32C2C	LA2K-32C2VC					
			Silver	DPDT	LA2K-32C6C	—					
	D		Gold	DPDT	LA2K-32C2D	LA2K-32C2VD					
			Silver	DPDT	LA2K-32C6D	—					
	H		Gold	DPDT	LA2K-32C2H	LA2K-32C2VH					
			Silver	DPDT	LA2K-32C6H	—					
Spring return two-way	D		Gold	DPDT	LA2K-33C2D	LA2K-33C2VD					
			Silver	DPDT	LA2K-33C6D	—					

- For contact operation, see page 19.
- Two keys are supplied.
- L-shaped lever contact types are also available for collective mounting.
To order L-shaped contact types, specify "T" in place of "C" in the Type No.

Example: (Standard contact type) LA2K-2C1A (L-shaped lever contact type) LA2K-2T1A

LA3K Key Selector Switches









Shape	Position		Key Retained at ●	Contact Material	Contact	Type No.	
						Solder/Tab Terminal	PC Board Terminal
Rectangular LA3K  	90° 2-position	Maintained	A 	Gold	SPDT	LA3K-2C1A	LA3K-2C1VA
					DPDT	LA3K-2C2A	LA3K-2C2VA
			Silver	SPDT	LA3K-2C5A	—	
				DPDT	LA3K-2C6A	—	
			Gold	SPDT	LA3K-2C1B	LA3K-2C1VB	
				DPDT	LA3K-2C2B	LA3K-2C2VB	
		Silver	SPDT	LA3K-2C5B	—		
			DPDT	LA3K-2C6B	—		
		C 	Gold	SPDT	LA3K-2C1C	LA3K-2C1VC	
				DPDT	LA3K-2C2C	LA3K-2C2VC	
			Silver	SPDT	LA3K-2C5C	—	
				DPDT	LA3K-2C6C	—	
	Spring return from right		B 	Silver	SPDT	LA3K-21C1B	LA3K-21C1VB
					DPDT	LA3K-21C2B	LA3K-21C2VB
		Gold	SPDT	LA3K-21C5B	—		
			DPDT	LA3K-21C6B	—		
	45° 3-position	Maintained	A 	Gold	DPDT	LA3K-3C2A	LA3K-3C2VA
					Silver	DPDT	LA3K-3C6A
			B 	Gold	DPDT	LA3K-3C2B	LA3K-3C2VB
					Silver	DPDT	LA3K-3C6B
			C 	Gold	DPDT	LA3K-3C2C	LA3K-3C2VC
					Silver	DPDT	LA3K-3C6C
			D 	Gold	DPDT	LA3K-3C2D	LA3K-3C2VD
					Silver	DPDT	LA3K-3C6D
			E 	Gold	DPDT	LA3K-3C2E	LA3K-3C2VE
					Silver	DPDT	LA3K-3C6E
			G 	Gold	DPDT	LA3K-3C2G	LA3K-3C2VG
					Silver	DPDT	LA3K-3C6G
		H 	Gold	DPDT	LA3K-3C2H	LA3K-3C2VH	
				Silver	DPDT	LA3K-3C6H	—
		Spring return from right	B 	Gold	DPDT	LA3K-31C2B	LA3K-31C2VB
					Silver	DPDT	LA3K-31C6B
D 			Gold	DPDT	LA3K-31C2D	LA3K-31C2VD	
				Silver	DPDT	LA3K-31C6D	—
G 			Gold	DPDT	LA3K-31C2G	LA3K-31C2VG	
				Silver	DPDT	LA3K-31C6G	—
Spring return from left		C 	Gold	DPDT	LA3K-32C2C	LA3K-32C2VC	
				Silver	DPDT	LA3K-32C6C	—
		D 	Gold	DPDT	LA3K-32C2D	LA3K-32C2VD	
				Silver	DPDT	LA3K-32C6D	—
	H 	Gold	DPDT	LA3K-32C2H	LA3K-32C2VH		
			Silver	DPDT	LA3K-32C6H	—	
Spring return two-way	D 	Gold	DPDT	LA3K-33C2D	LA3K-33C2VD		
			Silver	DPDT	LA3K-33C6D	—	

- For contact operation, see page 19.
- Two keys are supplied.
- L-shaped lever contact types are also available for collective mounting.
To order L-shaped contact types, specify "T" in place of "C" in the Type No.

Example: (Standard contact type) LA3K-2C1A (L-shaped lever contact type) LA3K-2T1A

ø16 L6 Series Miniature Control Units



LA1F Illuminated Selector Switches

Shape	Operation Type	Contact Material	Operating Voltage	Contact	Type No.		② Color Code			
					Solder/Tab Terminal	PC Board Terminal				
 	90° 2-position	Maintained 	Gold	5V DC ±5%	SPDT	LA1F-2C11②	LA1F-2C11V②	A: amber G: green R: red W: white S: blue Y: yellow		
					DPDT	LA1F-2C21②	LA1F-2C21V②			
				12V AC/DC ±10%	SPDT	LA1F-2C13②	LA1F-2C13V②			
					DPDT	LA1F-2C23②	LA1F-2C23V②			
				24V AC/DC ±10%	SPDT	LA1F-2C14②	LA1F-2C14V②			
					DPDT	LA1F-2C24②	LA1F-2C24V②			
			Silver	5V DC ±5%	SPDT	LA1F-2C51②	—			
					DPDT	LA1F-2C61②	—			
				12V AC/DC ±10%	SPDT	LA1F-2C53②	—			
					DPDT	LA1F-2C63②	—			
				24V AC/DC ±10%	SPDT	LA1F-2C54②	—			
					DPDT	LA1F-2C64②	—			
		Spring return from right 	Gold	5V DC ±5%	SPDT	LA1F-21C11②	LA1F-21C11V②			
					DPDT	LA1F-21C21②	LA1F-21C21V②			
				12V AC/DC ±10%	SPDT	LA1F-21C13②	LA1F-21C13V②			
					DPDT	LA1F-21C23②	LA1F-21C23V②			
				24V AC/DC ±10%	SPDT	LA1F-21C14②	LA1F-21C14V②			
					DPDT	LA1F-21C24②	LA1F-21C24V②			
			Silver	5V DC ±5%	SPDT	LA1F-21C51②	—			
					DPDT	LA1F-21C61②	—			
				12V AC/DC ±10%	SPDT	LA1F-21C53②	—			
					DPDT	LA1F-21C63②	—			
				24V AC/DC ±10%	SPDT	LA1F-21C54②	—			
					DPDT	LA1F-21C64②	—			
	45° 3-position	Maintained 	Gold	5V DC ±5%	DPDT	LA1F-3C21②	LA1F-3C21V②			
					DPDT	LA1F-3C23②	LA1F-3C23V②			
				12V AC/DC ±10%	DPDT	LA1F-3C24②	LA1F-3C24V②			
					DPDT	LA1F-3C24②	LA1F-3C24V②			
				Silver	5V DC ±5%	DPDT	LA1F-3C61②		—	
						DPDT	LA1F-3C63②		—	
			12V AC/DC ±10%		DPDT	LA1F-3C63②	—			
					DPDT	LA1F-3C64②	—			
			Spring return from right 		Gold	5V DC ±5%	DPDT		LA1F-31C21②	LA1F-31C21V②
							DPDT		LA1F-31C23②	LA1F-31C23V②
				12V AC/DC ±10%		DPDT	LA1F-31C24②		LA1F-31C24V②	
						DPDT	LA1F-31C24②		LA1F-31C24V②	
		Silver		5V DC ±5%		DPDT	LA1F-31C61②		—	
						DPDT	LA1F-31C63②		—	
				12V AC/DC ±10%	DPDT	LA1F-31C63②	—			
					DPDT	LA1F-31C64②	—			
				Spring return from left 	Gold	5V DC ±5%	DPDT		LA1F-32C21②	LA1F-32C21V②
							DPDT		LA1F-32C23②	LA1F-32C23V②
		12V AC/DC ±10%				DPDT	LA1F-32C24②		LA1F-32C24V②	
						DPDT	LA1F-32C24②		LA1F-32C24V②	
		Silver	5V DC ±5%			DPDT	LA1F-32C61②		—	
						DPDT	LA1F-32C63②		—	
			12V AC/DC ±10%		DPDT	LA1F-32C63②	—			
					DPDT	LA1F-32C64②	—			
Spring return two-way 	Gold		5V DC ±5%		DPDT	LA1F-33C21②	LA1F-33C21V②			
			12V AC/DC ±10%		DPDT	LA1F-33C23②	LA1F-33C23V②			
		24V AC/DC ±10%	DPDT		LA1F-33C24②	LA1F-33C24V②				
	Silver	5V DC ±5%	DPDT		LA1F-33C61②	—				
		12V AC/DC ±10%	DPDT	LA1F-33C63②	—					
		24V AC/DC ±10%	DPDT	LA1F-33C64②	—					

- Specify a color code in place of ② in the Type No.
- For contact operation, see page 19.
- L-shaped lever contact types are also available for collective mounting. To order L-shaped contact types, specify "T" in place of "C" in the Type No.

Example: (Standard contact type) LA1F-2C11② (L-shaped lever contact type) LA1F-2T11②







LA2F Illuminated Selector Switches

Shape	Operation Type	Contact Material	Operating Voltage	Contact	Type No.		② Color Code	
					Solder/Tab Terminal	PC Board Terminal		
Square LA2F  	90° 2-position	Maintained	Gold	5V DC ±5%	SPDT	LA2F-2C11②	LA2F-2C11V②	A: amber G: green R: red W: white S: blue Y: yellow
				12V AC/DC ±10%	DPDT	LA2F-2C21②	LA2F-2C21V②	
				24V AC/DC ±10%	SPDT	LA2F-2C13②	LA2F-2C13V②	
				DPDT	LA2F-2C23②	LA2F-2C23V②		
				SPDT	LA2F-2C14②	LA2F-2C14V②		
				DPDT	LA2F-2C24②	LA2F-2C24V②		
		Silver	5V DC ±5%	SPDT	LA2F-2C51②	—		
			12V AC/DC ±10%	DPDT	LA2F-2C61②	—		
			24V AC/DC ±10%	SPDT	LA2F-2C53②	—		
				DPDT	LA2F-2C63②	—		
				SPDT	LA2F-2C54②	—		
				DPDT	LA2F-2C64②	—		
		Spring return from right	Gold	5V DC ±5%	SPDT	LA2F-21C11②	LA2F-21C11V②	
				12V AC/DC ±10%	DPDT	LA2F-21C21②	LA2F-21C21V②	
				24V AC/DC ±10%	SPDT	LA2F-21C13②	LA2F-21C13V②	
				DPDT	LA2F-21C23②	LA2F-21C23V②		
				SPDT	LA2F-21C14②	LA2F-21C14V②		
				DPDT	LA2F-21C24②	LA2F-21C24V②		
		Silver	5V DC ±5%	SPDT	LA2F-21C51②	—		
			12V AC/DC ±10%	DPDT	LA2F-21C61②	—		
			24V AC/DC ±10%	SPDT	LA2F-21C53②	—		
				DPDT	LA2F-21C63②	—		
				SPDT	LA2F-21C54②	—		
				DPDT	LA2F-21C64②	—		
	45° 3-position	Maintained	Gold	5V DC ±5%	DPDT	LA2F-3C21②	LA2F-3C21V②	
				12V AC/DC ±10%	DPDT	LA2F-3C23②	LA2F-3C23V②	
				24V AC/DC ±10%	DPDT	LA2F-3C24②	LA2F-3C24V②	
			Silver	5V DC ±5%	DPDT	LA2F-3C61②	—	
				12V AC/DC ±10%	DPDT	LA2F-3C63②	—	
				24V AC/DC ±10%	DPDT	LA2F-3C64②	—	
		Spring return from right	Gold	5V DC ±5%	DPDT	LA2F-31C21②	LA2F-31C21V②	
				12V AC/DC ±10%	DPDT	LA2F-31C23②	LA2F-31C23V②	
				24V AC/DC ±10%	DPDT	LA2F-31C24②	LA2F-31C24V②	
			Silver	5V DC ±5%	DPDT	LA2F-31C61②	—	
				12V AC/DC ±10%	DPDT	LA2F-31C63②	—	
				24V AC/DC ±10%	DPDT	LA2F-31C64②	—	
		Spring return from left	Gold	5V DC ±5%	DPDT	LA2F-32C21②	LA2F-32C21V②	
				12V AC/DC ±10%	DPDT	LA2F-32C23②	LA2F-32C23V②	
				24V AC/DC ±10%	DPDT	LA2F-32C24②	LA2F-32C24V②	
			Silver	5V DC ±5%	DPDT	LA2F-32C61②	—	
				12V AC/DC ±10%	DPDT	LA2F-32C63②	—	
				24V AC/DC ±10%	DPDT	LA2F-32C64②	—	
		Spring return two-way	Gold	5V DC ±5%	DPDT	LA2F-33C21②	LA2F-33C21V②	
				12V AC/DC ±10%	DPDT	LA2F-33C23②	LA2F-33C23V②	
				24V AC/DC ±10%	DPDT	LA2F-33C24②	LA2F-33C24V②	
			Silver	5V DC ±5%	DPDT	LA2F-33C61②	—	
				12V AC/DC ±10%	DPDT	LA2F-33C63②	—	
				24V AC/DC ±10%	DPDT	LA2F-33C64②	—	

- Specify a color code in place of ② in the Type No.
- For contact operation, see page 19.
- L-shaped lever contact types are also available for collective mounting.
To order L-shaped contact types, specify "T" in place of "C" in the Type No.

Example: (Standard contact type) LA2F-2C11② (L-shaped lever contact type) LA2F-2T11②

LA3F Illuminated Selector Switches

Shape	Operation Type	Contact Material	Operating Voltage	Contact	Type No.		② Color Code	
					Solder/Tab Terminal	PC Board Terminal		
Rectangular LA3F  RU CE	90° 2-position	Maintained 	Gold	5V DC ±5%	SPDT	LA3F-2C11②	LA3F-2C11V②	A: amber G: green R: red W: white S: blue Y: yellow
					DPDT	LA3F-2C21②	LA3F-2C21V②	
				12V AC/DC ±10%	SPDT	LA3F-2C13②	LA3F-2C13V②	
			DPDT		LA3F-2C23②	LA3F-2C23V②		
			24V AC/DC ±10%	SPDT	LA3F-2C14②	LA3F-2C14V②		
				DPDT	LA3F-2C24②	LA3F-2C24V②		
		Silver	5V DC ±5%	SPDT	LA3F-2C51②	—		
				DPDT	LA3F-2C61②	—		
			12V AC/DC ±10%	SPDT	LA3F-2C53②	—		
				DPDT	LA3F-2C63②	—		
			24V AC/DC ±10%	SPDT	LA3F-2C54②	—		
				DPDT	LA3F-2C64②	—		
		Spring return from right 	Gold	5V DC ±5%	SPDT	LA3F-21C11②	LA3F-21C11V②	
					DPDT	LA3F-21C21②	LA3F-21C21V②	
				12V AC/DC ±10%	SPDT	LA3F-21C13②	LA3F-21C13V②	
			DPDT		LA3F-21C23②	LA3F-21C23V②		
			24V AC/DC ±10%	SPDT	LA3F-21C14②	LA3F-21C14V②		
				DPDT	LA3F-21C24②	LA3F-21C24V②		
		Silver	5V DC ±5%	SPDT	LA3F-21C51②	—		
				DPDT	LA3F-21C61②	—		
			12V AC/DC ±10%	SPDT	LA3F-21C53②	—		
				DPDT	LA3F-21C63②	—		
			24V AC/DC ±10%	SPDT	LA3F-21C54②	—		
				DPDT	LA3F-21C64②	—		
	45° 3-position	Maintained 	Gold	5V DC ±5%	DPDT	LA3F-3C21②	LA3F-3C21V②	
					DPDT	LA3F-3C23②	LA3F-3C23V②	
				12V AC/DC ±10%	DPDT	LA3F-3C24②	LA3F-3C24V②	
			24V AC/DC ±10%		DPDT	LA3F-3C24②	LA3F-3C24V②	
				Silver	5V DC ±5%	DPDT	LA3F-3C61②	
			DPDT			LA3F-3C63②	—	
		DPDT	LA3F-3C64②		—			
		Spring return from right 	Gold	5V DC ±5%	DPDT	LA3F-31C21②	LA3F-31C21V②	
					DPDT	LA3F-31C23②	LA3F-31C23V②	
				12V AC/DC ±10%	DPDT	LA3F-31C24②	LA3F-31C24V②	
			24V AC/DC ±10%		DPDT	LA3F-31C24②	LA3F-31C24V②	
				Silver	5V DC ±5%	DPDT	LA3F-31C61②	
			DPDT			LA3F-31C63②	—	
		DPDT	LA3F-31C64②		—			
		Spring return from left 	Gold	5V DC ±5%	DPDT	LA3F-32C21②	LA3F-32C21V②	
					DPDT	LA3F-32C23②	LA3F-32C23V②	
				12V AC/DC ±10%	DPDT	LA3F-32C24②	LA3F-32C24V②	
			24V AC/DC ±10%		DPDT	LA3F-32C24②	LA3F-32C24V②	
				Silver	5V DC ±5%	DPDT	LA3F-32C61②	
			DPDT			LA3F-32C63②	—	
		DPDT	LA3F-32C64②		—			
		Spring return two-way 	Gold	5V DC ±5%	DPDT	LA3F-33C21②	LA3F-33C21V②	
					DPDT	LA3F-33C23②	LA3F-33C23V②	
				12V AC/DC ±10%	DPDT	LA3F-33C24②	LA3F-33C24V②	
24V AC/DC ±10%	DPDT		LA3F-33C24②		LA3F-33C24V②			
	Silver		5V DC ±5%	DPDT	LA3F-33C61②	—		
DPDT				LA3F-33C63②	—			
DPDT		LA3F-33C64②	—					

- Specify a color code in place of ② in the Type No.
- For contact operation, see page 19.
- L-shaped lever contact types are also available for collective mounting. To order L-shaped contact types, specify "T" in place of "C" in the Type No.

Example: (Standard contact type) LA3F-2C11② (L-shaped lever type) LA3F-2T11②

Contact Operation

Operator Position and Contact Position (Top View)					
Positions		Contact	↙ Left	↑ Center	↘ Right
90° 2-Position	Maintained	SPDT	NO NC	—	NO NC
	Spring return from right		DPDT	Left Contact NO NC, Right Contact NO NC	—
45° 3-Position	Maintained	DPDT	Left Contact NO NC, Right Contact NO NC	Left Contact NO NC, Right Contact NO NC	Left Contact NO NC, Right Contact NO NC
	Spring return from right		Left Contact NO NC, Right Contact NO NC	Left Contact NO NC, Right Contact NO NC	Left Contact NO NC, Right Contact NO NC
	Spring return from left		Left Contact NO NC, Right Contact NO NC	Left Contact NO NC, Right Contact NO NC	Left Contact NO NC, Right Contact NO NC
	Spring return two-way		Left Contact NO NC, Right Contact NO NC	Left Contact NO NC, Right Contact NO NC	Left Contact NO NC, Right Contact NO NC

Dimensions

Selector Switches, Illuminated Selector Switches, Key Selector Switches

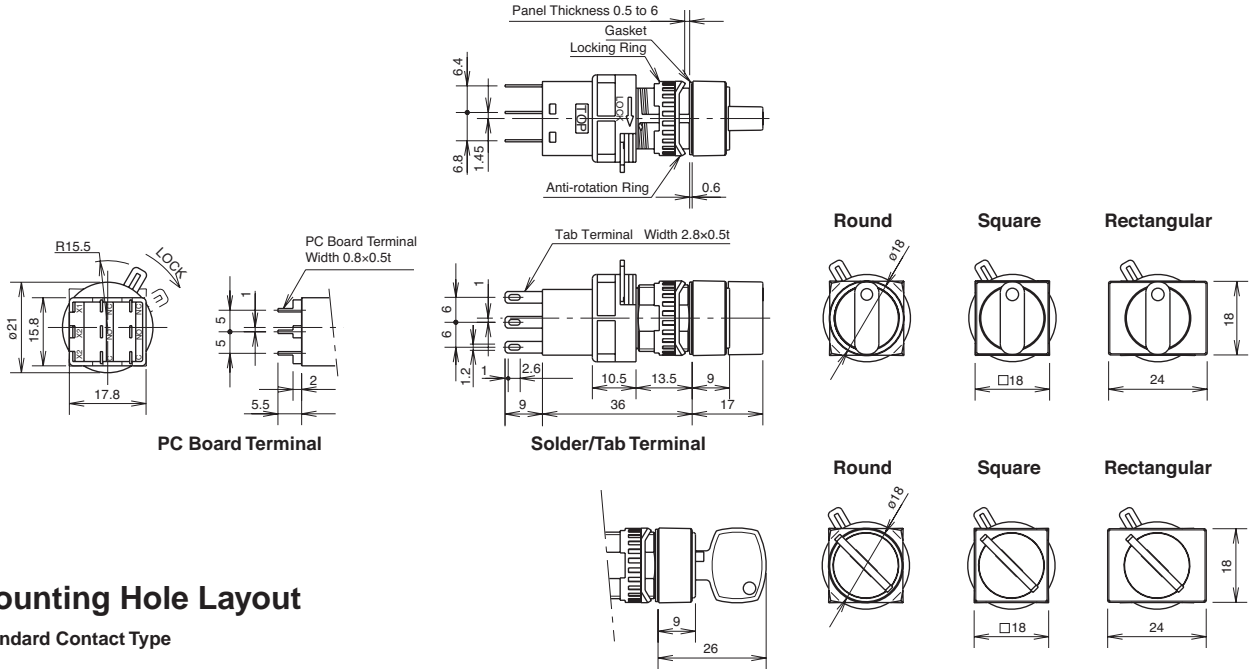

Mounting Hole Layout

Standard Contact Type

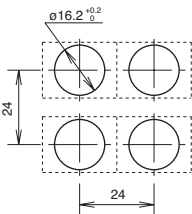

Note: Determine mounting centers to ensure easy operation.
• See page 26 for L-shaped lever contact types.

Terminal Arrangement (Bottom View)

Selector Switches Key Selector Switches

TOP

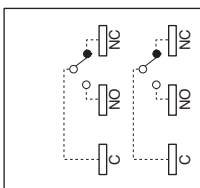

Illuminated Selector Switches

TOP

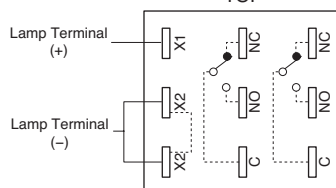

PC Board Drilling Layout (Bottom View)

Selector Switches Key Selector Switches

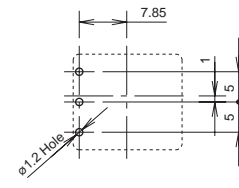

Illuminated Selector Switches

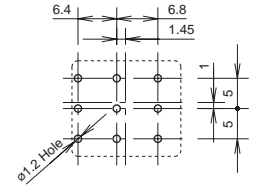

• See Single Board Mounting on page 26 for details about PC boards.

All dimensions in mm.

LA3Z Buzzers

Continuous / intermittent (slow) / intermittent (quick) sound can be selected with a built-in slide switch

- Collective mounting possible.
- Separate type control unit with locking lever, easy installation even when mounted collectively.
- Solder/tab and PC board terminal types available.
- Single board mounting possible.

Specifications

Insulation Voltage	60V AC/DC
Operating Voltage	6V AC/DC ±10% 12 to 24V AC/DC ±10%
Current Draw	AC: 20 mA, DC: 7 mA
Sound Pressure (at 0.1m)	Steady sound: 80 dB minimum (at the rated voltage)
Sound Frequency	2 kHz ±500Hz
Sound Cycle	Slow intermittent: 55 cycles per minute ±10% Quick intermittent: 600 cycles per minute ±10%
Operating Temperature	-20 to +55°C (no freezing)
Operating Humidity	45 to 85% RH (no condensation)
Insulation Resistance	100 MΩ minimum (500V DC megger)
Dielectric Strength	Between live and dead parts: 1,000V AC, 1 minute
Vibration Resistance	Operating extremes: 5 to 55 Hz, amplitude 0.5 mm
Shock Resistance	Damage limits: 1,000 m/s ² (100G)
Durability	1,000 hours minimum
Degree of Protection	IP40 (enclosed type)
Terminal Style	Solder/tab terminal #110 PC board terminal
Weight (approx.)	16g

Shape	Operating Voltage	Type No.	
		Solder/Tab Terminal	PC Board Terminal
Rectangular LA3Z 	6V AC/DC ±10%	LA3Z-1X2	LA3Z-1X2V
	12 to 24V AC/DC ±10%	LA3Z-1X4	LA3Z-1X4V

• L-shaped lever types are not available.

Dimensions

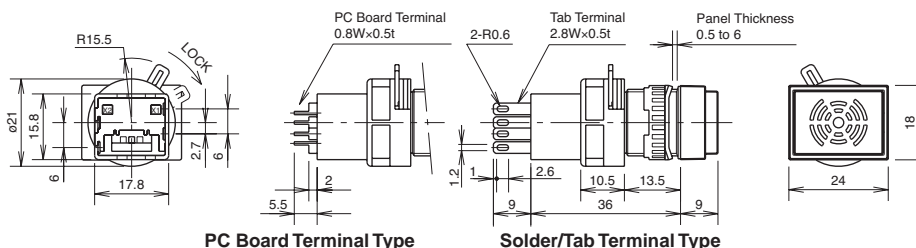

Terminal Arrangement (Bottom View)

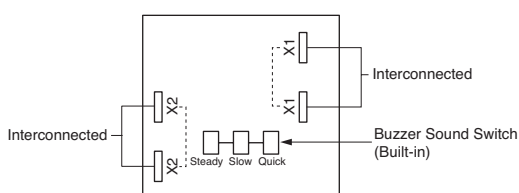

X1 and X1, X2 and X2 are connected internally.

Mounting Hole Layout

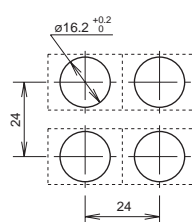

PC Board Layout (Bottom View)

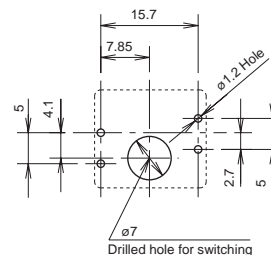









All dimensions in mm.

Accessories



Shape	Material	Type No.	Ordering Type No.	Package Quantity	Dimensions (mm)	
Locking Ring Wrench 	Metal (nickel-plated brass)	MT-001	MT-001	1	<ul style="list-style-type: none"> Used to tighten the locking ring when installing an L6 control unit onto a panel. Tighten the locking ring to a torque of 0.88 N·m maximum. 	
Lamp Holder Tool 	Rubber	OR-44	OR-44	1	<ul style="list-style-type: none"> Used to install and remove LED lamps. 	
Lens Removal Tool 	Stainless Steel	MT-101	MT-101	1	<ul style="list-style-type: none"> Used to remove lens and buttons. 	
Switch Guard (180° Spring return) 	Round/Square	Guard (polyarylate)	AL-K6SP	AL-K6SP	1	<ul style="list-style-type: none"> Degree of protection: IP65 Used to protect pushbuttons from inadvertent operation See page 24 for dimensions. 
	Rectangular	Base (polyacetal)	AL-KH6SP	AL-KH6SP	1	
Dust Cover 	Round	Elastomer (boot) Polypropylene (base)	AL-D6	AL-D6	1	<ul style="list-style-type: none"> Mounting centers will differ when the dust cover is used. (See page 24 for dimensions.) Operating temperature: -10 to +55°C See page 24 for dimensions.
	Square		AL-DQ6	AL-DQ6	1	
	Rectangular		AL-DH6	AL-DH6	1	
Terminal Cover 	Plastic (white)	H6-VL2	H6-VL2PN10	1	<ul style="list-style-type: none"> Terminal cover is not attached and must be ordered separately. When wiring the terminals, insert the lead wires into the terminal cover holes before soldering. Cannot be used for round and square L-shaped lever contact types. See page 24 for dimensions. 	
Mounting Hole Plug 	Rubber	Nitril rubber (black)	AL-B6	AL-B6PN05	5	<ul style="list-style-type: none"> Degree of protection: IP65 
	Metal	Metal diecast (Locking ring: plastic)	AL-BM6	AL-BM6	1	<ul style="list-style-type: none"> Degree of protection: IP65 

ø16 L6 Series Miniature Control Units

Maintenance Parts

Shape	For Use On	Material	Type No.	Ordering Type No.	Package Quantity	Color Code
	Round	Polyarylate	AL6M-L②	AL6M-L②PN05	5	Specify a color code in place of ② in the Ordering Type No. A: amber, C: clear, G: green, R: red, S: blue, Y: yellow Note: When the LED color is white, use a clear (C) lens.
	Square		AL6Q-L②	AL6Q-L②PN05		
	Rectangular		AL6H-L②	AL6H-L②PN05		
	Round	Polyarylate	AB6M-B①	AB6M-B① PN05	5	Specify a color code in place of ① in the Ordering Type No. B: black, G: green, R: red, S: blue, Y: yellow, W: white
	Square		AB6Q-B①	AB6Q-B① PN05		
	Rectangular		AB6H-B①	AB6H-B① PN05		
	Round	Acrylic	AL6M-W	AL6M-WPN05	5	<ul style="list-style-type: none"> • White • See page 25 for dimensions and engraving area.
	Square		AL6Q-W	AL6Q-WPN05		
	Rectangular		AL6H-W	AL6H-WPN05		
	All L6 control units	Plastic	HA9Z-LN	HA9Z-LNPN10	10	<ul style="list-style-type: none"> • Black
	All L6 control units	Stainless Steel	AL6-LP	AL6-LPPN10	10	
	All L6 control units except L-shaped lever contact types	Polyacetal	HA9Z-LS	HA9Z-LSPN05	5	<ul style="list-style-type: none"> • Safety lever lock is not attached and must be ordered separately.
	Key selector	Nickel-plated brass	AS6-SK-132	AS6-SK-132PN02	2	<ul style="list-style-type: none"> • Thickness: 2.0 mm
	Illuminated selector	Plastic	LA1A-F②	LA1A-F②PN02	2	Specify a color code in place of ② in the Ordering Type No. A: amber, G: green, R: red, S: blue, Y: yellow, W: white

LED Lamps

Operating Voltage	Current Draw		Type No.	Ordering Type No.	② Illumination Color Code	Package Quantity	Base
	AC	DC					
5V DC ±5% 	—	8 mA	LFTD-5②	LFTD-5②	Specify a color code in place of ② in the Ordering Type No. A: amber G: green R: red S: blue W: white Y: yellow	1	SX6S/8×5.4
				LFTD-5②PN10		10	
12V AC/DC ±10% 	9 mA	8 mA	LFTD-1②	LFTD-1②		1	
				LFTD-1②PN10		10	
24V AC/DC ±10% 	9 mA	8 mA	LFTD-2②	LFTD-2②		1	
				LFTD-2②PN10		10	

Transformer

Shape	Primary Voltage	Secondary Voltage	Type No.	Applicable LED Lamp
Separate Mounting Type for 24V 	100/110V AC	24V AC, 0.5W	TWR512	LFTD-2②
	200/220V AC		TWR522	
	400/440V AC		TWR542	

- Terminal covers are supplied.
- Connect only one LFTD LED lamp to each transformer.
- Use plastic mounting clip BC9Z-E/NS35N when mounting 400/440V AC primary voltage models.

Specifications

Operating Voltage	100/110V AC, 200/220V AC, 400/440V AC (50/60 Hz)	
Power Consumption	2.4VA	
Rated Insulation Voltage	600V	
Insulation Resistance	100 MΩ minimum (500V DC megger)	
Dielectric Strength	2500V AC, 1 minute	
Standard Operating Condition	Operating Temperature	-30 to +60°C (no freezing)
	Relative Humidity	35 to 85% (no condensation)
Vibration Resistance	Operating Extremes	5 to 55 Hz, amplitude 0.5 mm
Shock Resistance	Damage Limits	1,000 m/s ² (100G)
Terminal Screw	M3.5	
Applicable Wire	2 mm ² maximum, 2 wires maximum	

Dimensions

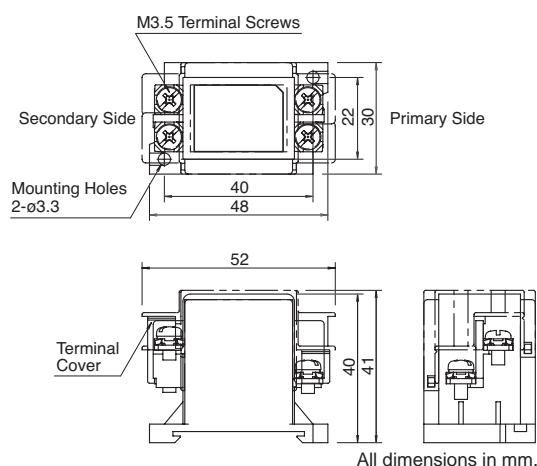

Accessories

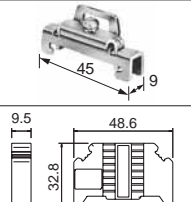
Description	Appearance	Description	Type No.	Ordering Type No.	Package Quantity
DIN Rail		Aluminum Weight: Approx. 200g Length: 1m	BAA1000	BAA1000PN10	10
		Steel Weight: Approx. 320g Length: 1m	BAP1000	BAP1000PN10	
Mounting Clip		Steel Weight: Approx. 15g	BNL6	BNL6PN10	
		Plastic Weight: Approx. 15g	BC9Z-E/NS35N	BC9Z-E/NS35NPN10	

- Use plastic mounting clip BC9Z-E/NS35N when using 400/440V AC primary voltage transformers.

Ø16 L6 Series Miniature Control Units

Dimensions

• Switch Guard

For Round/Square Units (AL-K6SP)

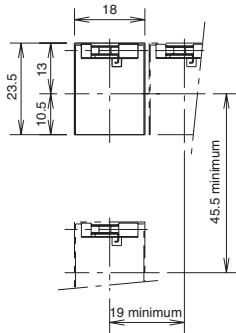

For Rectangular Units (AL-KH6SP)

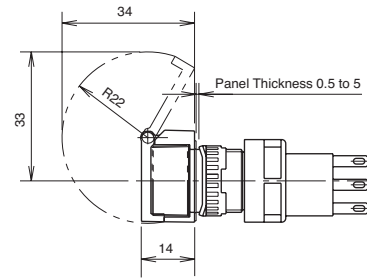
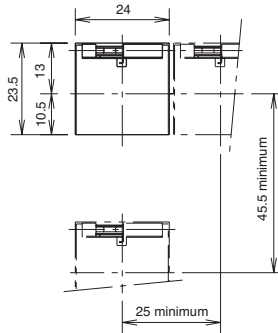

• Dust Cover

For Round Units (AL-DM6)

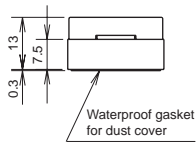
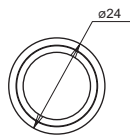

For Square Units (AL-DQ6)

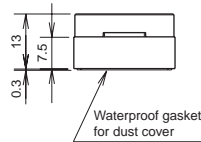
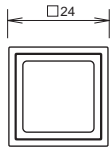

For Rectangular Units (AL-DH6)

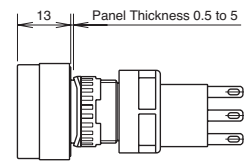
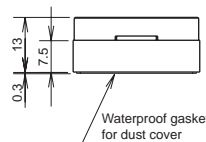
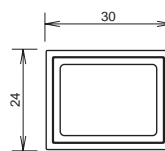

Mounting Hole Layout

Round/Square Units

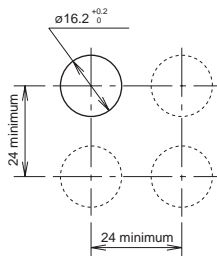

Rectangular Units

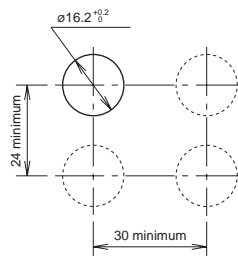

Note: Determine mounting centers to ensure easy operation.

• Terminal Cover

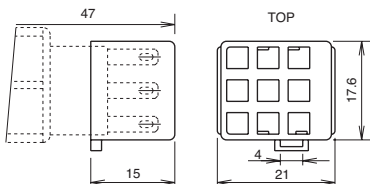

Depth behind the panel when using terminal cover: 47 mm

• Marking Plate

Shape	Size	Engraving area
Round	Ø13.7 mm	Ø12 mm
Square	□13.7 mm	□12 mm
Rectangular	13.7×19.7 mm	12×18 mm

Engraving depth: 0.5 mm maximum

Safety Precautions

- Turn off power to the L6 series control units before installation, removal, wiring, maintenance, and inspection. Failure to turn power off may cause electrical shocks or fire hazard.
- To avoid burning your hand, use the lamp holder tool when replacing lamps.
- For wiring, use wires of proper size to meet the voltage and current requirements. Improper soldering may cause overheating and create a fire hazard.

Instructions

Replacement of Lens and Marking Plate

• Removal

Remove the operator (color lens, marking plate, lens holder, and spring) by holding the color lens recesses with the Lens Removal Tool (MT-101) and pulling it out. Remove the marking plate by disengaging the latches between the color lens and lens holder. The marking plate must be engraved on the front side as shown below.

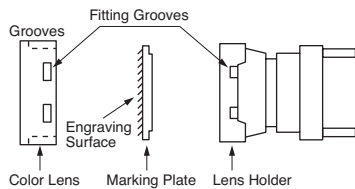

When using a color film, insert it between the color lens and marking plate.

Illumination selector knob can be removed by turning the knob and pulling it out.

• Installation

Place the marking plate on the lens holder in the correct direction, and press the color lens onto the lens holder to engage the latches. Insert the lens holder into the housing in the correct direction.

Marking

For L6 series illuminated pushbuttons, legends and symbols can be engraved on the built-in marking plates, or printed film can be inserted under the lens.

• Marking Plate & Engraving Area

Lens	Round	Square	Rectangular
Built-in Marking Plate			
	<ul style="list-style-type: none"> • Engraving must be made on the engraving area less than 0.5mm deep. • The marking plate is made of white acrylic resin. 		
Applicable Marking Film			
	<ul style="list-style-type: none"> • Two 0.1mm-thick films or one 0.2mm-thick film can be installed in the lens. • Marking film is not supplied. • Recommended marking film: Polyester film 		

Replacing the LED Lamp

Lamps can be replaced using the lamp holder tool (OR-44) from the front of the panel, or by removing the contact block from the operator unit.

• Removing the LED lamp from the front of the panel

1. Slip the lamp holder tool onto the lamp head. Then push slightly, and turn the lamp holder tool counterclockwise.



2. Press the lamp head to remove from the lamp holder.



• Installing the LED lamp from the front of the panel

1. Insert the LED lamp head into the lamp holder. Make sure that the lamp is pushed in completely.
2. Hold the bulb with the lamp holder tool (OR-44) as shown below.

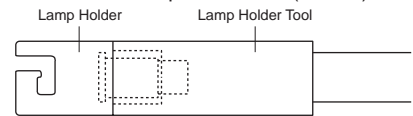

3. Place the insertion guide of the lamp holder and the TOP marking side or the groove in the operator unit in the same direction. Insert the lamp holder into the housing with the lamp holder tool. Then push the lamp lightly and turn it clockwise to install.

• Replacing the LED lamp by removing the contact block

The LED lamp can be replaced easily by removing the contact block.



Panel Mounting

Remove the contact block from the operator. Insert the operator into the panel cut-out from the front, then install the contact block to the operator.

• Removing the contact block



Turn the locking lever on the contact block in the direction opposite to the arrow on the housing. Then the contact block can be removed.

• Installing the contact block

Insert the contact block with the TOP markings on the contact block and the operator placed in the same direction. Then lock the units, turning the locking lever in the direction of the arrow.

• Notes for mounting

Use the optional Ring Wrench (MT-001) to mount the operator onto a panel. Tightening torque should not exceed 0.88 N·m. Do not use pliers. Do not tighten with excessive force, otherwise the locking ring will be damaged.

Instructions

Wiring

Solder the terminal at 350°C within 3 seconds using a 60W soldering iron. Sn-Ag-Cu type is recommended when using lead-free solder. When soldering, do not touch the switch housing with the soldering iron. Also ensure that no tensile force is applied to the terminal. Do not bend the terminal or apply excessive force to the terminal.

Use a non-corrosive rosin flux.

Notes on Terminal Cover

Insert the terminal cover into the contact block with the TOP markings on the contact block and the terminal cover in the same direction.

Note: When wiring, insert the lead wires into the terminal cover holes before soldering.

L-Shaped Lever Contact Type

L-shaped lever contact types are available for 18-mm mounting centers, except buzzers. (Rectangular types have 24-mm mounting centers.)

To order L-shaped lever contact types, specify "T" in place of "C" in the Type No.

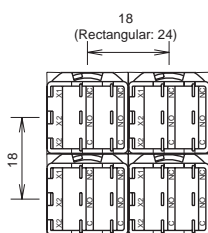

Example: (Standard contact type) LA1L-M1C14② (L-shaped lever contact type) LA1L-M1T14②

Dimensions

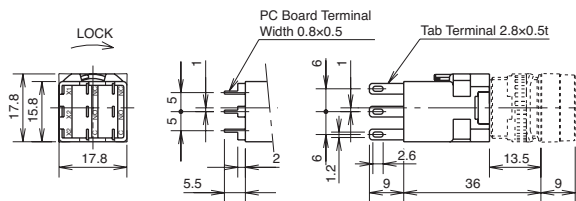

Mounting Hole Layout

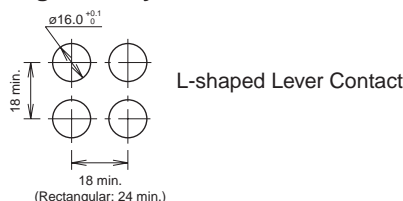

Connection

Positive lock connectors and easy-lock connectors can be used on the tab terminals.

Recommended Connectors

Item	Positive-lock Connector (Tyco Electronics)		Easy-lock Connector (Nichifu Co., Ltd.)	
Terminal	0.2 to 0.5 mm ²	175412-1	0.2 to 0.3 mm ²	OSS-62852F3
	0.2 to 1.25 mm ²	174778-1	0.5 to 1.25 mm ²	OSS-62815F3
Housing	174779-1		NET1-28-1P	

Note: Positive-lock is a registered trademark of Tyco Electronics.

Single Board Mounting

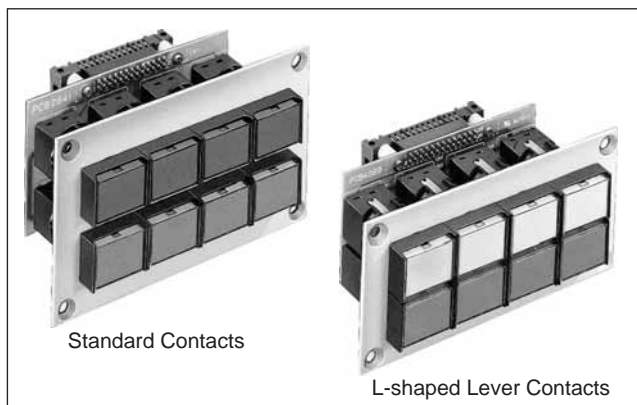

Mounting PC board terminal control units on a PC board offers the following features.

Features

- Reduced installation labor, easy wiring, space saving, and standardization.
- Since the contact blocks on the PC board can be removed easily using a locking lever, the L6 series control units are easy to maintain.
- Because the L6 series control units require no studs for fastening the control unit to a PC board, special preparation of the control panel is not needed.

Notes for Designing PC board and Circuit

- Use 1.6-mm-thick glass epoxy PC board with drilled holes.
- Design a circuit so that the L6 series control unit can operate within the rated voltage and current range. Make sure that inrush current and voltage do not exceed the rating.

- Minimum applicable load is 5V AC/DC, 1 mA on gold contacts. Applicable range is subject to the operating condition and load.
- Since the 2.8-mm-wide terminal touches the PC board as shown on the right, short circuit may occur with pattern lines. Design a circuit carefully to prevent short circuit.

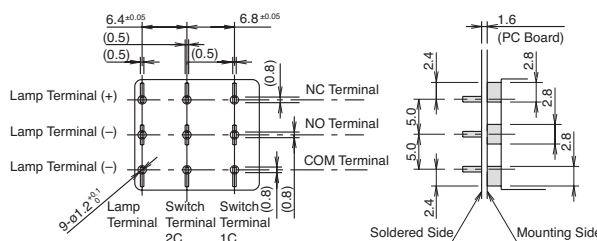

PC Board Drilling Layout (Bottom View)

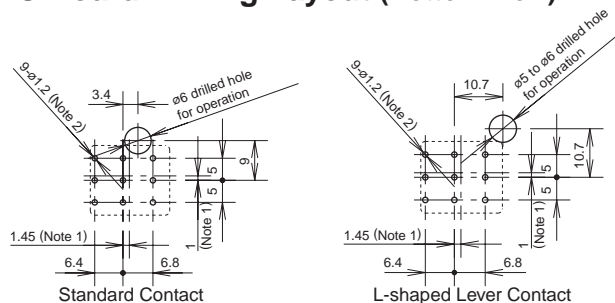

Note 1: When designing, note the alignment of centerlines of the contact blocks and centerlines of the operators.

Note 2: The diameter of the terminal hole is 1.2 mm.

Single Board Mounting

Installation and Removal of Contact Blocks

Turn the locking lever to install and remove contact blocks on the PC board using a screwdriver from a hole (standard contact $\phi 6$ mm, L-shaped lever contact $\phi 5$ mm to $\phi 6$ mm) in the PC board. The locking lever can be used for both standard contact types and L-shaped lever contact types but determine location of the control units so that the locking lever can be operated.

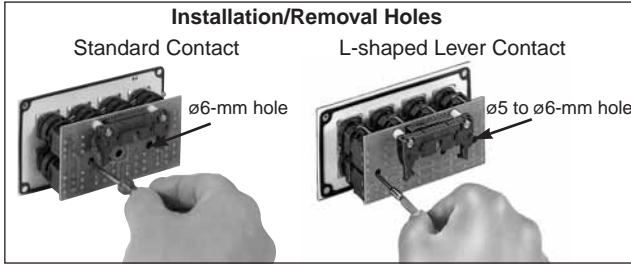

Hole diameter may vary to meet installation requirements. When the locking lever can be accessed by using a screwdriver from the upper or right space, holes are not necessary.

<Example>

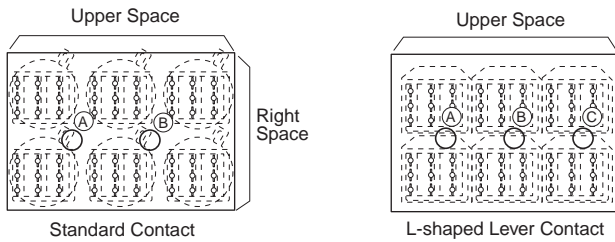

Switch Guard for Single Board Mounting



Specification: Rectangular type
Degree of Protection: IP65
Type No.: LA9Z-K3

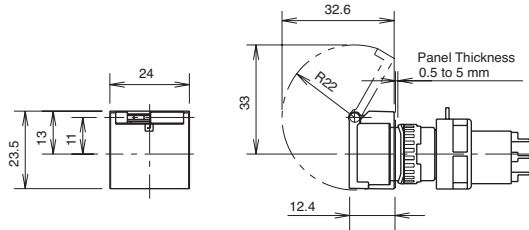

Note: The panel depth is the same for control units with or without switch guards. Both types can be installed on the same PC board.

Mounting Holes and Assembly Procedure

Drill mounting holes in the panel as shown below. When the units are mounted collectively, provide adequate clearance.

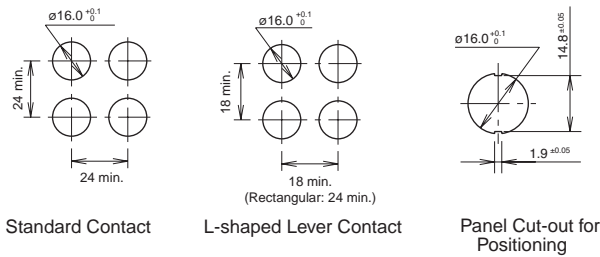

• Assembly Procedure

1. Install the operator to the panel.
2. Mount the contact block to the operator from the rear.
3. Turn the locking lever to lock the contact block.
4. Insert the PC board to terminals and solder.

Note 1: Make sure that each terminal is inserted into the PC board correctly.

Note 2: Do not apply tensile force to the connector cable for an extended period of time.

Note 3: Do not expose the contact block to water.

Note 4: Ensure to lock contact blocks when the contact blocks are installed on the operators.