



The KRDB Series is a compact time delay relay measuring only 2 in. (50.8 mm) square. Its microcontroller timing circuit provides excellent repeat accuracy and stability. Encapsulation protects against shock, vibration, and humidity. The KRDB Series is a cost effective approach for OEM applications that require small size, isolation, reliability, and long life.

### Operation (Delay-on-Break):

Input voltage must be applied before and during timing. Upon closure of the initiate switch, the output relay energizes. The time delay begins when the initiate switch is opened. The output remains energized during timing. At the end of the time delay, the output de-energizes. The output will energize if the initiate switch is closed when input voltage is applied.

Reset: Reclosing the initiate switch during timing resets the time delay. Loss of input voltage resets the time delay and output.

For more information see: Appendix A, pages 156-164 for function descriptions and diagrams. Appendix B, page 165, Figure 1 for dimensional drawing.

### Connection:

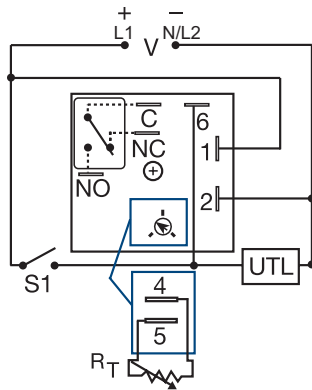

V = Voltage  
 S1 = Initiate Switch  
 C = Common, Transfer Contact  
 NO = Normally Open  
 NC = Normally Closed  
 UTL = Untimed Load (optional)  
 A knob is supplied for adjustable units. The untimed load is optional. Relay contacts are isolated.

### External Resistance vs. Time Delay:

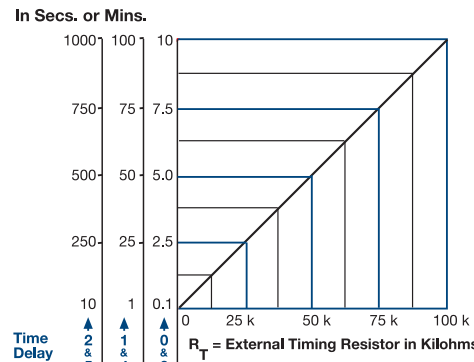

**This chart applies to externally adjustable part numbers.**  
 The time delay is adjustable over the time delay range selected by varying the resistance across the RT terminals; as the resistance increases the time delay increases.  
 When selecting an external RT, add the tolerances of the timer and the RT for the full time range adjustment.  
**Examples:** 1 to 50 S adjustable time delay, select time delay range 1 and a 50 K ohm RT. For 1 to 100 S use a 100 K ohm RT.

### Order Table:

KRDB	X	X	X
Input Voltage	Adjustment	Time Delay*	
-1 - 12VDC	-1 - Fixed	-0 - 0.1 - 10s	
-2 - 24VAC/DC	-2 - Onboard knob	-1 - 1 - 100s	
-3 - 24VDC	-3 - External adjust	-2 - 10 - 1000s	
-4 - 120VAC		-3 - 0.1 - 10m	
-5 - 110VDC		-4 - 1 - 100m	
-6 - 230VAC		-5 - 10 - 1000m	

\*If fixed delay is selected, insert delay (0.1 - 1000) followed by (S) sec, or (M) min.

### Specifications

<b>Time Delay</b>		<b>Max. Switching Voltage</b> . . . . . 250VAC
Type . . . . .	Microcontroller with watchdog circuitry	<b>Life (Operations)</b> . . . . . Mechanical - 1 x 10 <sup>7</sup> ; Electrical - 1 x 10 <sup>5</sup>
Range . . . . .	0.1s - 1000m in 6 adjustable ranges or fixed	<b>Protection</b>
Repeat Accuracy . . . . .	±0.5% or 20ms, whichever is greater	Circuitry . . . . . Encapsulated
Tolerance (Factory Calibration) . . . . .	±5%	Isolation Voltage . . . . . ≥ 1500V RMS input to output
Recycle Time . . . . .	≤ 150ms	Insulation Resistance . . . . . ≥ 100 MΩ
Initiate Time . . . . .	≤ 40ms	Polarity . . . . . DC units are reverse polarity protected
Time Delay vs Temp. & Voltage . . . . .	±5%	<b>Mechanical</b>
<b>Input</b>		Mounting . . . . . Surface mount with one #10 (M5 x 0.8) screw
Voltage . . . . .	12, 24, 110VDC; 24, 120 or 230VAC	Dimensions . . . . . 2 x 2 x 1.21 in. (50.8 x 50.8 x 30.7 mm)
Tolerance 12VDC & 24VDC/AC . . . . .	-15% - 20%	Termination . . . . . 0.25 in. (6.35 mm) male quick connect terminals
110VDC, 120 or 230VAC . . . . .	-20% - 10%	<b>Environmental</b>
AC Line Frequency / DC Ripple . . . . .	50/60 Hz / ≤ 10%	Operating / Storage Temperature . . . . . -40° to 60°C / -40° to 85°C
Power Consumption . . . . .	AC ≤ 2VA; DC ≤ 2W	Humidity . . . . . 95% relative, non-condensing
<b>Output</b>		Weight . . . . . ≈ 2.6 oz (74 g)
Type . . . . .	Isolated relay contacts	
Form . . . . .	SPDT	
Rating (at 40°C) . . . . .	10A resistive @ 125VAC; 5A resistive @ 230VAC & 28VDC; 1/4 hp @ 125VAC	

### Features:

- Compact time delay relay
  - Microcontroller circuitry
  - ±0.5% repeat accuracy
  - Isolated, 10A, SPDT output contacts
  - Factory fixed, onboard or external adjust
  - Delays from 0.1s - 1000m in 6 ranges
  - Input voltages from 12 to 230V in 6 options
  - ±5% factory calibration
- Approvals:

### Auxiliary Products:

- **External adjust potentiometer:**  
P/N: P1004-95  
P/N: P1004-95-X
- **Mounting bracket:** P/N: P1023-6
- **Female quick connect:**  
P/N: P1015-13 (AWG 10/12)  
P/N: P1015-64 (AWG 14/16)
- **Quick connect to screw adaptor:**  
P/N: P1015-18
- **Versa-knob:** P/N: P0700-7
- **DIN rail:** P/N: C103PM (Al)
- **DIN rail adaptor:** P/N: P1023-20

### Available Models:

KRDB110S	KRDB217S
KRDB112.5S	KRDB222
KRDB1120M	KRDB31120S
KRDB115M	KRDB415S
KRDB1160M	KRDB420
KRDB120	KRDB421
KRDB121	KRDB422
KRDB124	KRDB424
KRDB125	KRDB425

If desired part number is not listed, please call us to see if it is technically possible to build.

### Output Current/Ambient Temperature

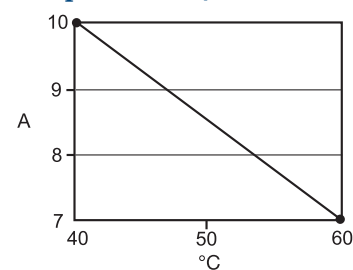

# Appendix A - Timer Functions

## Selecting a Timer's Function

Selecting one of the five most common timing functions can be as easy as answering three questions on the chart below. If you have trouble answering these questions, try drawing a connection diagram that shows how the timer and load are connected. Time diagrams and written descriptions of the five most popular functions, plus other common functions. Instantaneous contacts, accumulation, pause timing functions, and flashing LED's are included in some units to expand the versatility of the timer. These expanded operations are explained on the product's catalog page. Time diagrams are used on these pages along with text and international symbols for functions.

### Function Selection Guide

#### Selection Questions

- 1) The timing starts when the initiate (starting) contacts are:
  - A) Closed
  - B) Opened
- 2) What is the status of the output (or load) during timing:
  - A) On
  - B) Off
  - C) On/Off
- 3) Will the load de-energize (or remain de-energized) if the initiate (starting) contacts are opened during timing:
  - A) Yes
  - B) No

### THE FIVE MOST USED FUNCTIONS



### Understanding Time Diagrams

Time diagrams are used to show the relative operation of switches, controls, and loads as time progresses. Time begins at the first vertical boundary. There may be a line indicating the start of the operation or it may just begin with the transition of the device that starts the operation. Each row in the time diagram represents a separate component. These rows will be labeled with the name of the device or its terminal connection numbers. In a bistable or digital system, the switches, controls, or loads can only be ON or OFF. The time lines are drawn to represent these two possible conditions. Vertical lines are used to define important starting or ending points in the operation.

The example to the right is the most common type of time diagram in use in North America. It shows the energizing of loads, and the closing of switches and contacts by an ascending vertical transition of the time line. Opening switches or contacts or de-energizing loads are represented by descending vertical transitions.

### TIME DIAGRAM

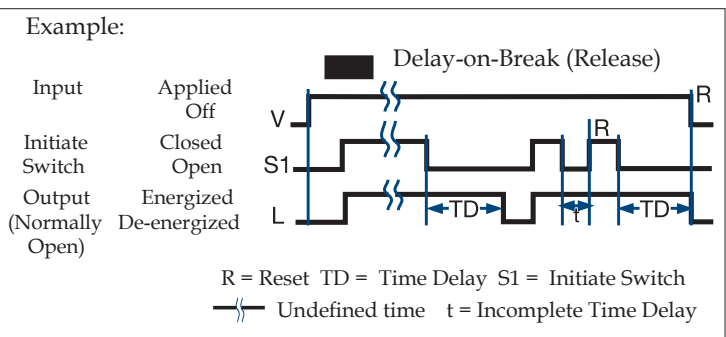

## INTERNATIONAL TIMING FUNCTION SYMBOLS

- |   |   |  |   |
|---|---|--|---|
|   | = Delay-on-Make; ON-delay                                   |  | = Flasher - OFF Time First; Recycling Equal Times - OFF First |
|   | = Delay-on-Break; OFF-delay                                 |  | = Recycling - Unequal Times; Pulse Generator                  |
|   | = Delay-on-Make & Break; ON and OFF-delay                   |  | = Recycling - Unequal Times Starting with ON or OFF           |
| 1 | = Interval; Impulse-ON                                      |  | = Delay-on-Make & Interval; Single Pulse Generator            |
| 1 | = Trailing Edge Interval; Impulse-OFF                       |  |   |
|   | = Single Shot; Pulse Former                                 |  |   |
|   | = Flasher - ON Time First; Recycling Equal Times - ON First |  |   |

### Delay-on-Make: (ProgramaCube® Function M)

(ON-delay, Delay on Operate, On Delay, Operate Delay, Delay On, Prepurge Delay)

OPERATION: Upon application of input voltage, the time delay begins. The output (relay or solid state) is de-energized before and during the time delay. At the end of the time delay, the output energizes and remains energized until input voltage is removed.

RESET: Removing input voltage resets the time delay and output.

See: HRPS, KRPS, KSPS, KSPU, NHPS, NHPU, TDM, TRDU

Extra Functions Included in Some Delay-on-Make (DOM) Timers:

### Accumulating Time Delay Feature: (ProgramaCube® Function AM)

Some DOM timers allow the time delay to be stopped and held and then resumed by opening and closing an external switch. The total time delay, TD is the sum of the accumulated partial time delays, "t".

See: KRPD, KRPS, HRPS, NHPS, KSPD, KSPS, TRDU

### Instantaneous Contacts:

Some DOM timers have a set of instantaneous contacts in addition to the delayed contacts. Instantaneous contacts energize when input voltage is applied and remain until voltage is removed.

### Delay-on-Make, Normally Closed Output:

All relay output delay-on-make timers with normally closed contacts include this function. (See Delay-on-Make NC Contacts) This function is also available in solid-state output timers. The solid-state output energizes when input voltage is applied. The time delay begins when an optional initiate switch S1 is closed (timing starts when voltage is applied if S1 is not used). The output de-energizes at the end of the time delay. Reset: Opening S1 resets the time delay and the output immediately energizes (or remains energized). Removing input voltage resets the time delay and de-energizes the output.

See: KSD4, THD4, TS4, TSD4

### Interval: (ProgramaCube® Function I)

(Impulse-ON, Single Pulse on Operate, On Interval, Interval On, Pulse Shaping, Bypass Timing)

OPERATION: Upon application of input voltage, the time delay begins. The output (relay or solid state) energizes during the time delay. At the end of time delay the output de-energizes and remains de-energized until input voltage is removed.

RESET: Removing input voltage resets the time delay and output.

See: HRPS, KRPS, KSPS, KSPU, NHPS, NHPU, TDI, TSD2

Extra Functions Included on Some Interval Timers:

### Instantaneous Contacts:

Some Interval timers have a set of instantaneous contacts in addition to the delayed contacts. Instantaneous contacts energize when input voltage is applied and remain until voltage is removed.

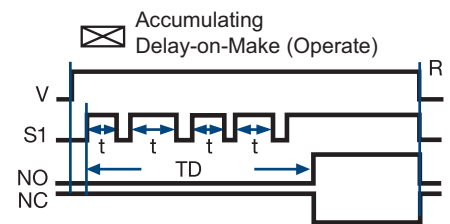
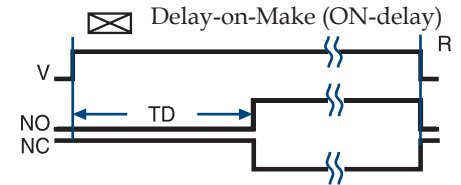

### Delay-on-Make (Normally Closed)

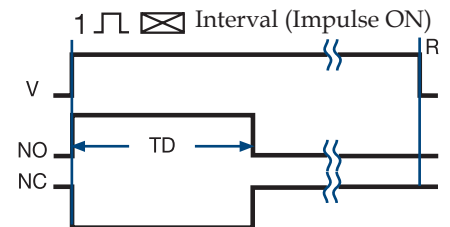
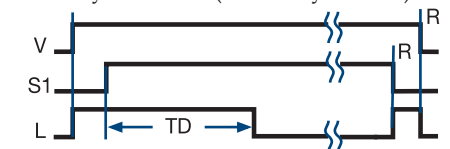

## Legend

- |                      |                                     |
|----------------------|-------------------------------------|
| V = Voltage          | NO = Normally Open Contact          |
| R = Reset            | NC = Normally Closed Contact        |
| TD = Time Delay      | t = Incomplete (Partial) Time Delay |
| S1 = Initiate Switch | L = Load                            |
|                      | = Undefined time                    |

# Appendix A - Timer Functions

## Timer Functions Popular Functions

### Recycling: (ProgramaCube® Functions RE, RD, RXE, RXD)

(Flasher, Pulse Generator, Recycle Timing, Repeat Cycle, Duty Cycling)

**OPERATION:** Upon application of input voltage, the output (relay or solid state) energizes and the ON time begins. At the end of the ON time, the output de-energizes and the OFF time begins. At the end of the OFF time, the output energizes and the cycle repeats as long as input voltage is applied. The OFF time may be the first delay in some recycling timers.

**RESET:** Removing input voltage resets the output and time delays, and returns the sequence to the first delay.

The time delays in some recycling timers are equal  $TD1=TD2$ . Flashers are an example of this type of recycling timer. Others have separately selectable time delays.

See: HRPD, HRPS, KRPD, KRPS, KSPD, KSPS, KSPU, NHPD, NHPS, NHPU, TDR

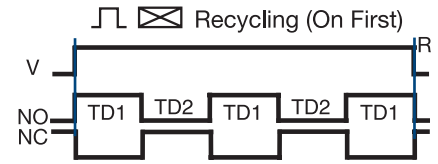

Extra Functions Included in Some Recycling Timers:

#### Instantaneous Contacts:

Some Recycling timers have a set of instantaneous contacts in addition to the delayed contacts. Instantaneous contacts energize when input voltage is applied and remain until voltage is removed.

**RESET SWITCH:** Closing an external switch transfers the output and resets the sequence to the first delay. See: HRDR

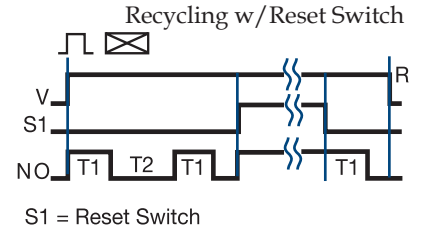

### Delay-on-Break: (ProgramaCube® Function B)

(Delay on Release, OFF-delay, Release Delay, Postpurge Delay)

**OPERATION:** Input voltage must be applied before and during timing. Upon closure of the initiate switch, the output (relay or solid state) energizes. The time delay begins when the initiate switch is opened. The output remains energized during timing. At the end of the time delay, the output de-energizes. The output will energize if the initiate switch is closed when input voltage is applied.

**RESET:** Reclosing the initiate switch during timing resets the time delay. Removing input voltage resets the time delay and output.

See: HRPS, HRPDU, KRPS, KSPS, KSPU, NHPS, NHPU, TRDU, TDB

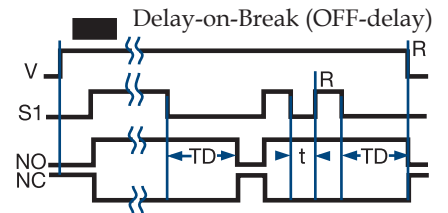

Extra Functions Included in Some Delay-on-Break (DOB) Timers:

#### Instantaneous Contacts:

Some DOB timers have a set of instantaneous contacts in addition to the delayed contacts. Instantaneous contacts energize when input voltage is applied and remain until voltage is removed.

Related Functions:

### Inverted Delay-on-Break: (ProgramaCube® Function UB)

**OPERATION:** Input voltage must be applied before and during timing. Upon closure of the initiate switch S1, the output (relay or solid state) de-energizes. The time delay begins when S1 is opened. The output remains de-energized during timing. At the end of the time delay, the output energizes. The output remains de-energized if S1 is closed when input voltage is applied.

**RESET:** Reclosing S1 during timing resets the time delay. Removing input voltage resets the time delay and output.

See: HRPS, HRPDU, KRPS, KSPS, KSPU, NHPS, NHPU, TRDU

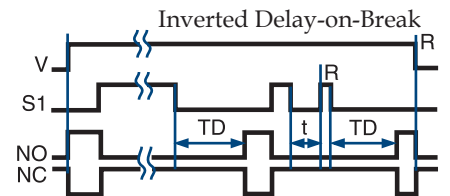

#### Legend

V = Voltage	NO = Normally Open Contact
R = Reset	NC = Normally Closed Contact
T1 = ON Time	t = Incomplete Time Delay
T2 = OFF Time	TD, TD1, TD2 = Time Delay
S1 = Initiate Switch	— = Undefined Time

## Single Shot: (ProgramaCube® Functions S or SD)

(Pulse Former, One Shot Relay, Single Shot Interval, Pulse Shaping)

**OPERATION:** Input voltage must be applied before and during timing. Upon momentary or maintained closure of the initiate switch, the output (relay or solid state) energizes and the time delay begins. At the end of the delay, the output de-energizes. Opening or reclosing the initiate switch during timing has no effect on the time delay. Note (for most single shot timers): If the initiate switch is closed when input voltage is applied, the output energizes and the time delay begins.

**RESET:** Reset occurs when the time delay is complete and the initiate switch is opened. Removing input voltage resets the time delay and output.

See: HRPS, HRPV, KRPS, KSPS, KSPV, NHPS, NHPV, TDS, TSDS, TRDV

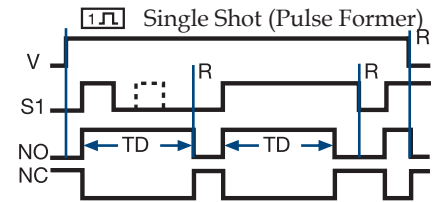

Extra Functions Included in Some Single Shot Timers:

### Instantaneous Contacts:

Some Single Shot timers have a set of instantaneous contacts in addition to the delayed contacts. Instantaneous contacts energize when input voltage is applied and remain until voltage is removed.

Related Functions:

## Retriggerable Single Shot (Motion Detector): (ProgramaCube® Function PSD)

(Motion Detector, Zero Speed Switch, Watchdog Timer, Missing Pulse Timer)

**OPERATION:** Input voltage must be applied prior to and during timing. The output (relay or solid state) is de-energized. When the initiate switch S1 closes momentarily or maintained, the output energizes and the time delay begins. Upon completion of the delay, the output de-energizes.

**RESET:** Reclosing S1 resets the time delay and restarts timing. Removing input voltage resets the time delay and output.

See: HRD9, HRPS, HRPV, KR D9, KRPS, KSPS, KSPV, NHPS, NHPV, TRDV, TRU

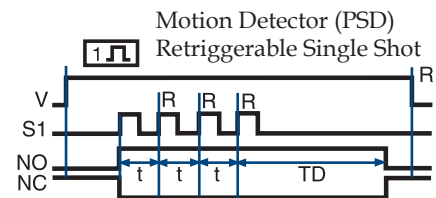

## Retriggerable Single Shot (Motion Detector): (ProgramaCube® Function PSE)

**OPERATION:** Similar to retriggerable single shot function PSD above except, when input voltage is applied, the output (relay or solid state) immediately energizes and timing begins. At the end of the time delay, the output de-energizes. The unit will timeout as long as S1 remains open or closed for a full time delay period.

**RESET:** During timing, reclosing S1 resets and restarts the time delay and the output remains energized. After timeout, reclosing S1 starts a new operation. Removing input voltage resets the time delay and the output.

See: KR D9

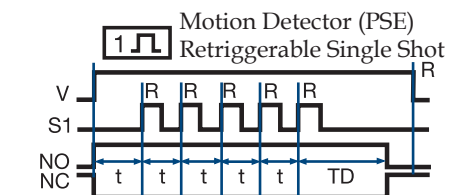

## Inverted Single Shot: (ProgramaCube® Function US)

**OPERATION:** Input voltage must be applied before and during timing. Upon momentary or maintained closure of the initiate switch S1, the output (relay or solid state) de-energizes. At the end of the time delay, the output energizes. Opening or reclosing S1 during timing has no effect on the time delay. The output will remain de-energized if S1 is closed when input voltage is applied.

**RESET:** Reset occurs when the time delay is complete and S1 is open. Removing input voltage resets the time delay and output.

See: HRPS, HRPV, KRPS, KSPS, KSPV, NHPS, NHPV, TRDV

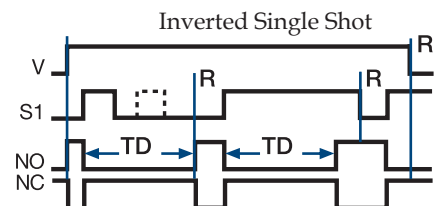

## Trailing Edge Single Shot (Impulse-OFF): (ProgramaCube® Function TS)

**OPERATION:** Input voltage must be applied before and during timing. When the initiate switch S1 opens, the output (relay or solid state) energizes. At the end of the time delay, the output de-energizes. Reclosing and opening S1 during timing has no effect on the time delay. The output will not energize if S1 is open when input voltage is applied.

**RESET:** Reset occurs when the time delay is complete and S1 is closed. Removing input voltage resets the time delay and output.

See: HRPS, KRPS, KSPS, KSPV, NHPV, TRDV

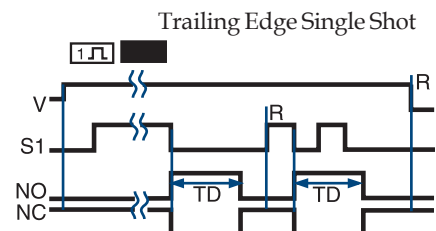

# Appendix A - Timer Functions

## Timer Functions

### Two Functions in One Timer

#### Delay-on-Make/Delay-on-Break: (ProgramaCube® Function MB)

(ON-delay/OFF-delay, Delay on Operate/Delay on Release, Sequencing ON & OFF, Fan Delay, Prepurge & Postpurge)

**OPERATION:** Input voltage must be applied at all times. The output (relay or solid state) is de-energized. Upon closure of the S1 initiate switch, the delay-on-make time delay (TD1) begins. At the end of TD1, the output (relay or solid state) energizes. Opening S1 starts the delay-on-break time delay (TD2). At the end of TD2, the output de-energizes.

**RESET:** Removing input voltage resets time delays and the output. If S1 is a) opened during TD1, then TD1 is reset and the output remains de-energized. b) reclosed during TD2, then TD2 is reset and the output remains energized.

See: HRPD, KRPD, KSPD, NHPD

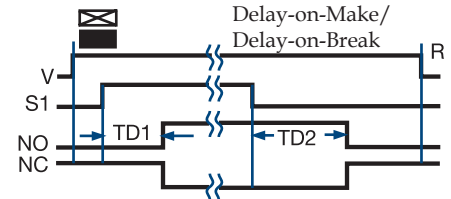

Extra Functions Included in Some Delay-on-Make/Delay-on-Break Timers:

#### Instantaneous Contacts:

Some DOM/DOB timers have a set of instantaneous contacts in addition to the delayed contacts. Instantaneous contacts energize when input voltage is applied and remain until voltage is removed.

#### Delay-on-Make/Interval: (ProgramaCube® Function MI)

(Single Pulse Generator, Delayed Interval, Delay on Operate/Single Pulse on Operate)

**OPERATION:** Upon application of input voltage, the delay-on-make time delay (TD1) begins, the output remains de-energized. At the end of this delay, the output (relay or solid state) energizes and the interval delay (TD2) begins. At the end of the interval delay (TD2), the output de-energizes.

**RESET:** Removing input voltage resets the output, the time delays and returns the sequence to the first delay.

See: ESD5, HRPD, KRPD, KSPD, NHPD, TRDU

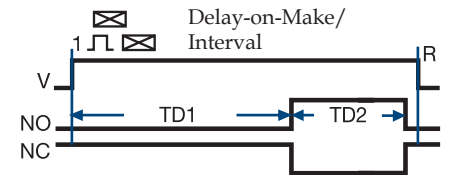

#### Accumulative Delay-on-Make/Interval: (ProgramaCube® Function AMI)

**OPERATION:** Input voltage must be applied before and during timing. The output is de-energized before and during the TD1 time delay. Each time S1 closes, the time delay progresses; when it opens, timing stops.

When the amount of time S1 is closed equals the full TD1 delay, the output (relay or solid state) energizes for TD2. Upon completion of TD2, the output relay de-energizes. Opening S1 during TD2 has no affect.

**RESET:** Removing input voltage resets the time delay, output relay, and the sequence to the first delay.

See: HRPD, KRPD, KSPD, NHPD

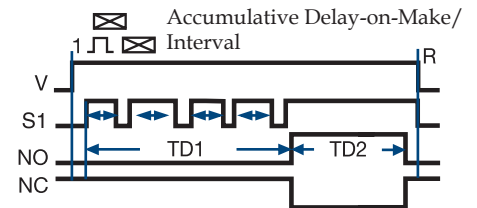

#### Legend

V = Voltage  
S1 = Initiate Switch  
R = Reset

TD1, TD2 = Time Delay  
NO = Normally Open  
NC = Normally Closed

}} = Undefined Time

## Timer Functions

### Two Functions in One Timer

#### Delay-on-Make/Recycle: (ProgramaCube® Function MRE)

OPERATION: Upon application of input voltage, TD1 begins and the output (relay or solid state) remains de-energized. At the end of TD1, the TD2 recycle function begins and the output (relay or solid state) cycles ON and OFF for equal delays. This cycle continues until input voltage is removed.

RESET: Removing input voltage resets the output and time delays, and returns the sequence to the first delay.

See: KSPD, KRPD, NHPD, HRPD, TRDU

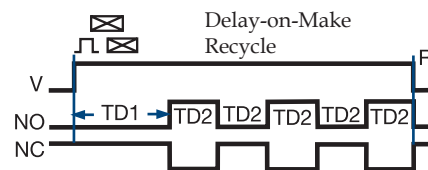

#### Delay-on-Make/Single Shot: (ProgramaCube® Function MS)

OPERATION: Upon application of input voltage and the closure of S1, TD1 begins and the output (relay or solid state) remains de-energized. The output (relay or solid state) energizes at the end of TD1, and TD2 begins. At the end of TD2, the output (relay or solid state) de-energizes. Opening or reclosing S1 during timing has no effect on the time delays.

RESET: Reset occurs when the time delay is complete and S1 is open. Removing input voltage resets the time delay, output, and the sequence to the first delay.

See: KSPD, KRPD, NHPD, HRPD, TRDU

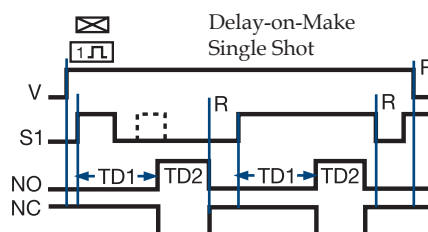

#### Interval/Recycle: (ProgramaCube® Function IRE)

OPERATION: Upon application of input voltage TD1 begins. At the same time, the TD2 ON time begins and the output (relay or solid state) energizes. At the end of the ON time, the TD2 OFF time begins and the output de-energizes. The equal ON time OFF time cycle continues until TD1 is completed at which time the output de-energizes.

RESET: Removing input voltage resets the time delays, output, and the sequence to the Interval function.

See: KSPD, KRPD, NHPD, HRPD, TRDU

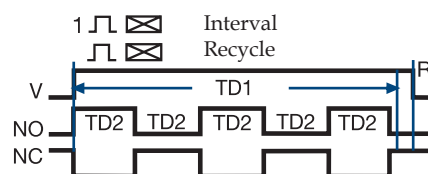

#### Delay-on-Break/Recycle: (ProgramaCube® Function BRE)

OPERATION: Upon application of input voltage and the closure of S1, the TD2 ON time begins and the output (relay or solid state) energizes. Upon completion of the ON time, the output de-energizes for the TD2 OFF time. At the end of the OFF time, the equal ON/OFF cycle repeats. When S1 opens, the TD1 delay begins. TD1 and TD2 run concurrently until the completion of TD1 at which time, the TD2 ON/OFF cycle terminates and the output de-energizes. The output energizes if S1 is closed when input voltage is applied.

RESET: Reclosing S1 during timing resets the TD1 time delay. Removing input voltage resets the time delay, output, and the sequence to the Delay-on-Break function.

See: KSPD, KRPD, NHPD, HRPD, TRDU

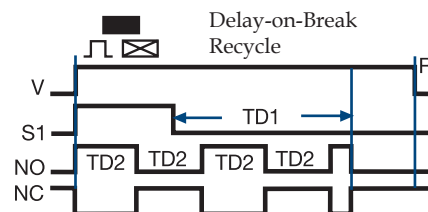

#### Single Shot/Recycle: (ProgramaCube® Function SRE)

OPERATION: Upon application of input voltage and the closure of S1, TD1 begins. At the same time, the TD2 ON time begins and the output (relay or solid state) energizes. Upon completion of the ON time, the output de-energizes for the TD2 OFF time. At the end of the OFF time, the equal ON/OFF cycle repeats. TD1 and TD2 run concurrently until the completion of TD1 at which time, the TD2 ON/OFF cycle terminates and the output de-energizes. Opening or reclosing S1 during timing has no effect on the time delays. The output will energize if S1 is closed when input voltage is applied.

RESET: Removing input voltage resets the time delay, output, and the sequence to the first delay.

See: HRPD, KRPD, KSPD, NHPD, TRDU

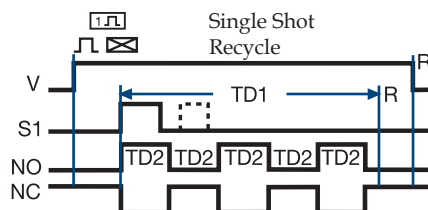

#### Single Shot/Lockout: (ProgramaCube® Function SL)

OPERATION: Upon application of input voltage and momentary or maintained closure of S1, the output (relay or solid state) energizes and TD1 single shot time delay begins. The output relay de-energizes at the end of TD1 and the TD2 lockout time delay begins. During TD2 (and TD1) closing switch S1 has no effect on the operation. After TD2 is complete, closing S1 starts another operation. If S1 is closed when input voltage is applied, the output energizes and the TD1 time delay begins.

RESET: Removing input voltage resets the time delays and the output and returns the cycle to the first delay.

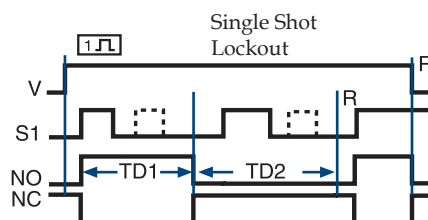

#### Interval/Delay-on-Make: (ProgramaCube® Function IM)

OPERATION: Upon application of input voltage, the output (relay or solid state) energizes and TD1 begins. At the end of TD1, the output de-energizes and TD2 begins. At the end of TD2, the output energizes.

RESET: Removing input voltage resets the time delays, output, and the sequence to the first delay.

See: HRPD, KRPD, KSPD, NHPD, TRDU

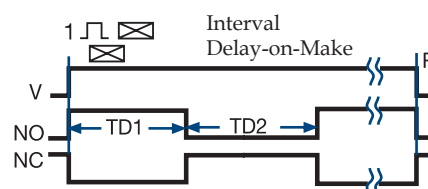

# Appendix A - Timer Functions

## Timer Functions Counting and Switching Functions

### Leading edge flip-flop: (ProgramaCube® Function F)

**OPERATION:** Input voltage must be applied before and during operation. The operation begins with the output (relay or solid state) de-energized. Upon momentary or maintained closure (leading edge triggered) of the initiate switch S1, the time delay begins. At the end of the time delay, the output energizes and remains energized. Opening or re-closing S1 during timing has no affect. After the output transfers, the next closure of S1 starts a new operation. Each time an S1 closure is recognized, the time delay occurs and then the output transfers, ON to OFF, OFF to ON, ON to OFF. The first operation will occur if S1 is closed when input voltage is applied.

**RESET:** Removing input voltage resets the time delay and the output to the de-energized state.  
Function can be applied to ProgramaCube Series: HRPS, KRPS, KSPS

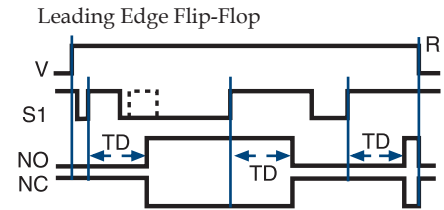

### Alternating Relay (Trailing edge flip-flop): (ProgramaCube® Function FT)

**OPERATION:** Input voltage must be applied at all times for proper operation. The operation begins with the output (relay or solid state) de-energized. Closing S1 enables the next alternating operation. When S1 opens (trailing edge triggered), the time delay begins. At the end of the time delay, the output energizes and remains energized until S1 is (re-closed and) re-opened. Then the output relay de-energizes and remains until S1 opens again. Each time S1 opens the time delay occurs and the output transfers.

**RESET:** Removing input voltage resets the output and the time delay.  
See: ARP, HRPS, KRPS

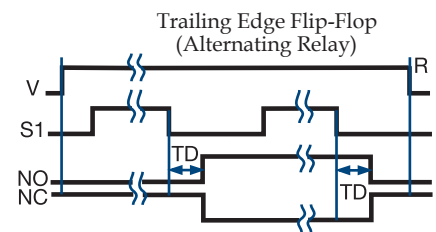

### Counter with Pulsed Output: (ProgramaCube® Function C)

Function Limited to Switch Adjustable ProgramaCubes®

**OPERATION:** Input voltage must be applied before and during operation. Each time S1 is closed, a count is added. When the total number of S1 closures equals the total count selected on the unit, the output energizes. The output remains energized for the pulse duration specified for the product, and then de-energizes. If S1 is closed while the output is energized, a count is not added. If S1 is closed when input voltage is applied, a count is not added.

**RESET:** The unit automatically resets at the end of each operation. Removing input voltage resets the output, counter, and pulse delay.  
See: HRPV, KSPV, NHPV

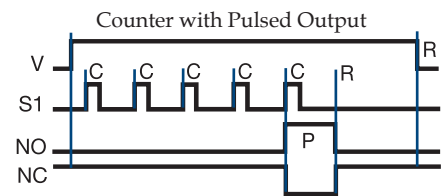

### Counter with Interval Output: (ProgramaCube® Function CI)

Function Limited to Switch Adjustable ProgramaCubes®

**OPERATION:** Input voltage must be applied before and during operation. Each time S1 is closed, a count is added. When the total number of S1 closures equals the total count selected on the unit, the output energizes and the interval time delay begins. The output de-energizes at the end of the time delay. If S1 is closed during the time delay, a count is not added. If S1 is closed when input voltage is applied, a count is not added.

**RESET:** The counter is reset during the time delay, the unit automatically resets at the end of the interval time delay. Removing input voltage resets the output, counter, and time delay.  
See: HRPV, HRV, HSPZ, KSPV, NHPV

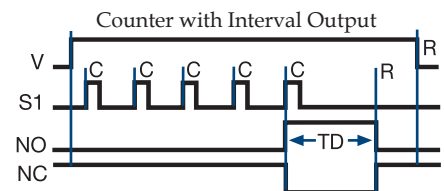

#### Legend

- V = Voltage
- R = Reset
- S1 = Initiate Switch
- Td, TD1, TD2 = Time Delay
- NO = Normally Open Contact
- NC = Normally Closed Contact
- C = Count
- P = Pulse Duration
- = Undefined Time



# Appendix B - Dimensional Drawings

FIGURE 1

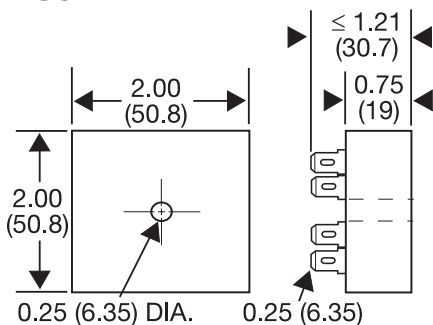

0.25 (6.35) DIA. 0.25 (6.35)

CT; ESD5; ESDR; FS100; FS200; FS300; KR3; KR9; KRDB; KRDI; KRDM; KRDR; KRDS; KRPD; KRPS; KSD1; KSD2; KSD3; KSD4; KSDB; KSDR; KSDS; KSDU; KSPD; KSPS; KSPU; KVM; T2D; TA; TAC1; TAC4; TDU; TDUB; TDUI; TDUS; TL; TMV8000; TS1; TS2; TS4; TS6; TSB; TSD1; TSD2; TSD3; TSD4; TSD6; TSD7; TSDB; TSDR; TSDS; TSS; TSU2000

FIGURE 2

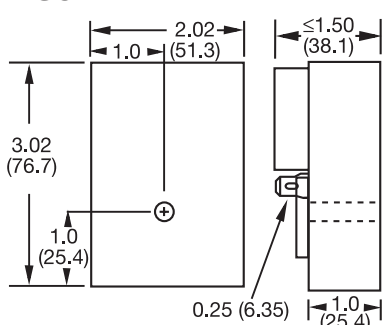

HLV; HRD3; HRD9; HRDB; HRDI; HRDM; HRDR; HRDS; HRID; HRIS; HRIU; HRPD; HRPS; HRPV; HRV; RS

FIGURE 3

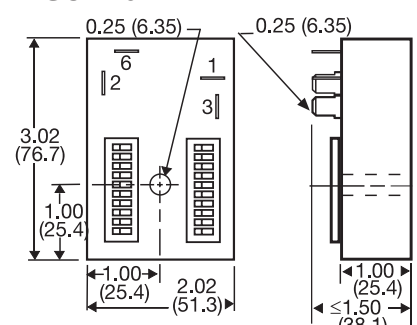

HSPZ

FIGURE 4

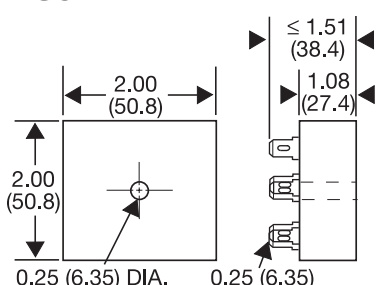

FA; FS; FSU1000\*; NHPD; NHPS; NHPV; NLF1\*; NLF2\*; PHS\*; PTHF\*; SIR1; SIR2; SLR1\*; SLR2\*; TH1; TH2; THC; THD1; THD2; THD3; THD4; THD7; THDB; THDM; THDS; THS

FIGURE 5

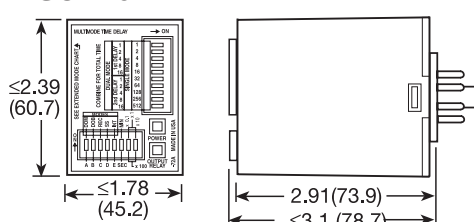

TRDU

FIGURE 6

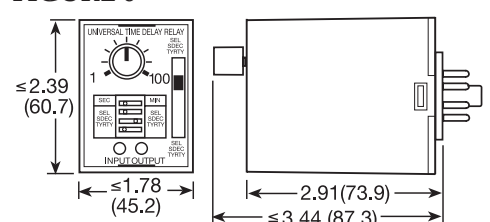

TRU

FIGURE 7

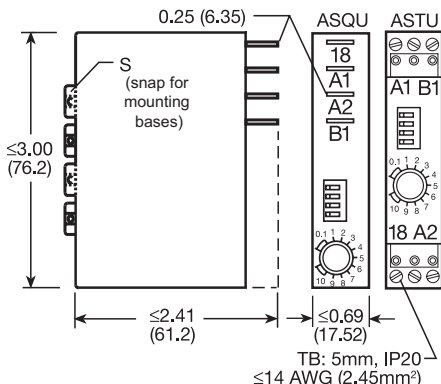

ASQU; ASTU; DSQU; DSTU

FIGURE 8

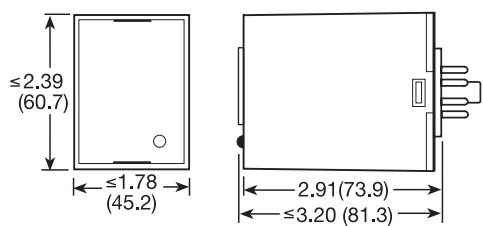

PLM; PLR; TDB; TDBH; TDBL; TDI; TDIH; TDIL; TDM; TDMB; TDMH; TDML; TDR; TDS; TDSH; TDSL

FIGURE 9

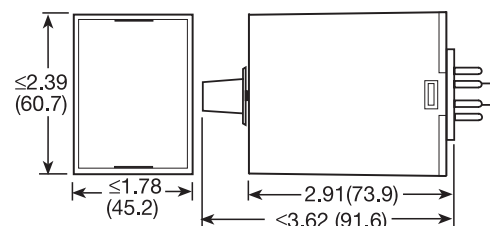

FS500; PRLB; PRLM; PRLS; TRB; TRM; TRS

FIGURE 10

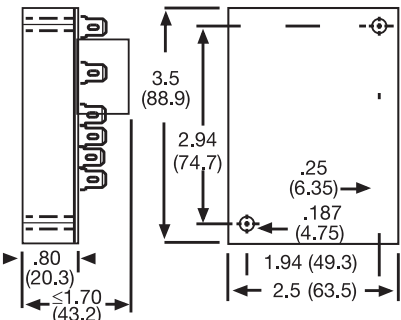

ERD3; ERDI; ERDM

FIGURE 11

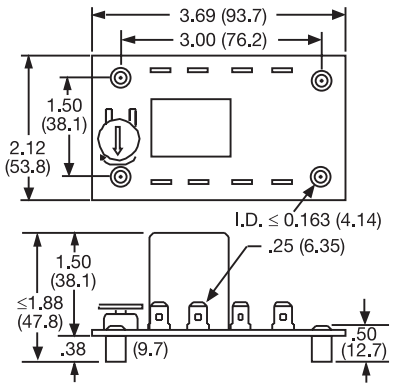

ORB; ORM; ORS

FIGURE 12

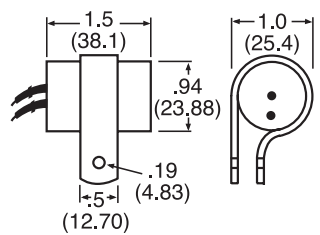

FS100; FS400

inches (millimeters)