

KG series

Power rocker switches

Distinctive features and specifications

- Illuminated or non-illuminated
- Protected rocker
- Sealed to IP 65
- Laser marking
- VDE (EN 61058-1) approved

ELECTRICAL SPECIFICATIONS

- Current/voltage rating :
 - functions 1 (ON-OFF) and 6 (ON-ON) : 15A 12VDC, 10A 24VDC, 15A 250VAC max., 10mA 14VDC min.
 - functions 4 (ON ON ON) and 4-1R (ON ON MOM) : 8A 12VDC, 5A 24VDC, 8A 250VAC max.
 - other functions : 10A 12VDC, 8A 24VDC, 10A 250VAC max.
- VDE approved ratings : 12(4)A 250VAC, T85/55°C
- Initial contact resistance : 10 mΩ max. at 1A 2VDC
- Insulation resistance : 1.000 MΩ min. at 500VDC
- Dielectric strength : 2.000 Vrms 50 Hz min. between terminals
- Electrical life : 10.000 cycles min.
- Mechanical life : 2 position models : 100.000 cycles min.
3 position models : 30.000 cycles min.

ENVIRONMENTAL SPECIFICATIONS

- Degree of protection : IP 65
- Shock resistance : 100 g according to IEC 512-4, test 6c
- Vibration resistance : 10-500 Hz - 10 g according to IEC 512-4, test 6d
- Salt spray resistance : 96 hours according to IEC 512-6, test 11f
- Moisture resistance : 56 days according to IEC 68-2-3
- Operating temperature : 2 position models : -40°C to + 85°C
3 position models : -10°C to + 65°C

MATRIX MOUNTING

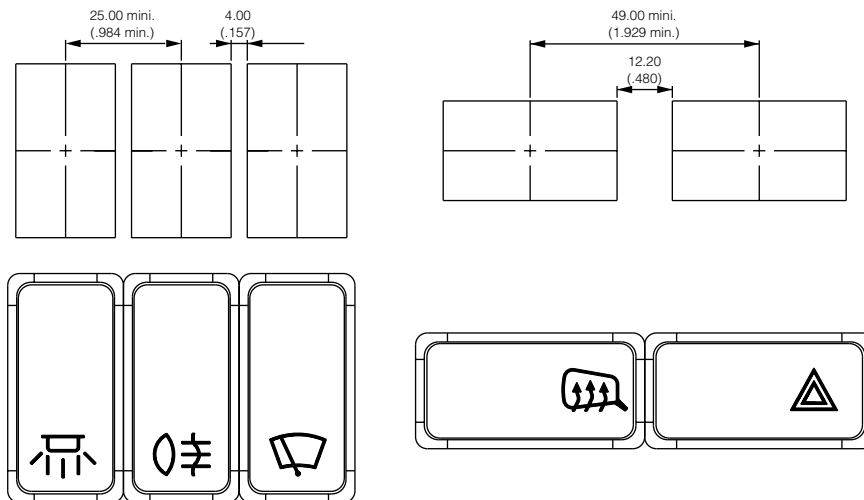

Dimensions : First dimensions are in mm while inches are shown as bracketed numbers.



Packaging unit : 40 pieces

MATERIALS

- Case and bezel : thermoplastic UL94-V0
- Terminals : brass, silver plated
- Contacts : silver grain
- Contact roller : brass, nickel plated

REAR PROTECTION OR SEALING

The KG switches are also available with wire lead terminals (lead 16AWG max.) :

- Models with **protection cover**, as shown on photo below,
- Models with **rear sealing** provided by the overmoulding of terminals in a resin base.

On request.



AGENCY APPROVAL



EN 61058-1

Availability : double pole models, functions ON-OFF and ON-ON.

Marking : to order switches marked VDE, add "VDE" at the end of model number.

KG series

Power rocker switches

Case

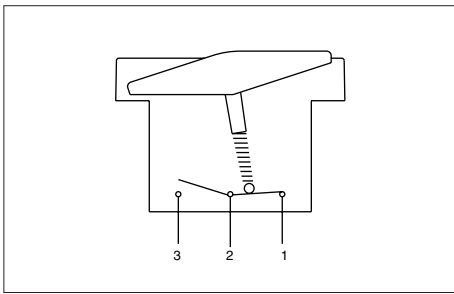

PANEL CUT-OUT

Panel thickness :
0,8 mm to 4,6 mm
Recommended thickness :
between 2 mm and 3,5 mm

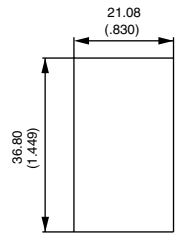

MODEL STRUCTURE

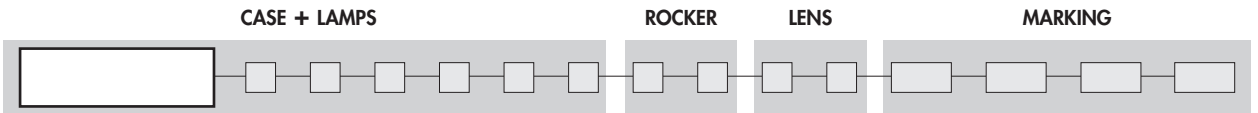

		2-3	1-2
		5-6	4-5
Single pole	Double pole		
KG31	KG41	ON - OFF	
	KG44*	ON ON ON	
	KG44-1R*	ON ON MOM	
KG35	KG45	MOM - ON	
KG36	KG46	ON - ON	
KG37	KG47	MOM OFF MOM	
KG38	KG48	ON OFF MOM	
KG39	KG49	ON OFF ON	

→ Flat seal

* Function 4 : single pole in double pole case

TERMINALS

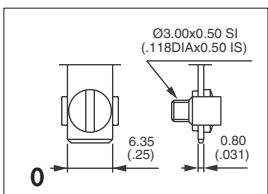
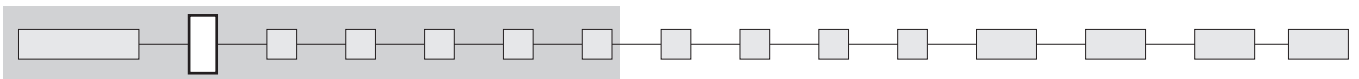

Screw

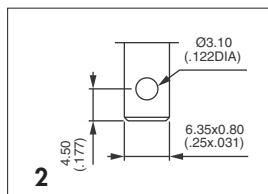

Solder lug / quick-connect

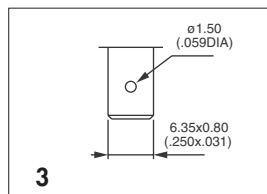

Quick-connect

Terminals 1 to 6 are marked on the case.

Side A : terminals 1 and 4
Side B : terminals 3 and 6

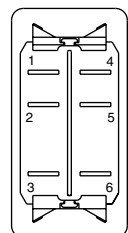

Side B

CONTACT MATERIALS

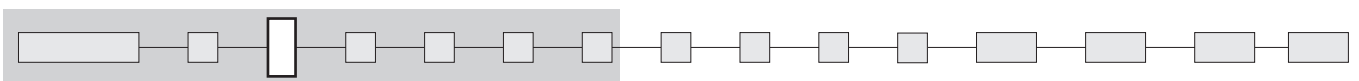

- A** Silver grain
 Functions ON-OFF and ON-ON : 15A 12VDC , 10A 24VDC, 15A 250VAC max. - 10mA 14 VDC min.
 Other functions : 10A 12VDC, 8A 24VDC, 10A 250VAC max.

KG series

Power rocker switches

Lamps

BEZEL

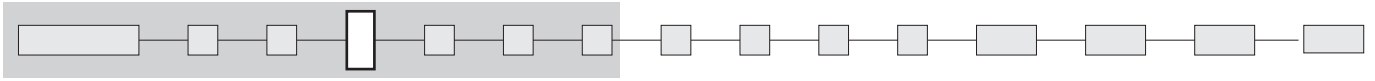

2 Black, sealed to IP 65

LAMPS

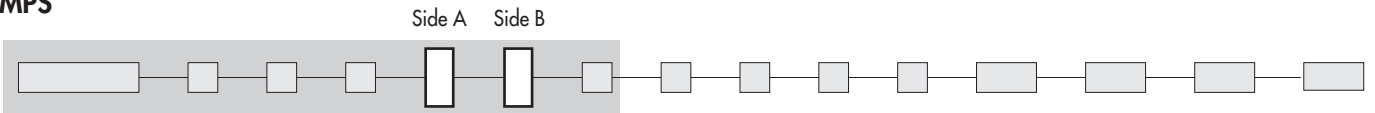

Complete each enlarged box with one of the codes listed below.

X	Without lamp
A	6V LED red
B	6V LED green
C	6V LED yellow
D	12V LED red
E	12V LED green
F	12V LED yellow
G	18V LED red
H	18V LED green
I	18V LED yellow

J	24V LED red
K	24V LED green
L	24V LED yellow
M	Neon 125V
N	Neon 250V
O	Filament 6V
P	Filament 12V
R	Filament 24V
S	Fluorescent 220V
T	Fluorescent 110V

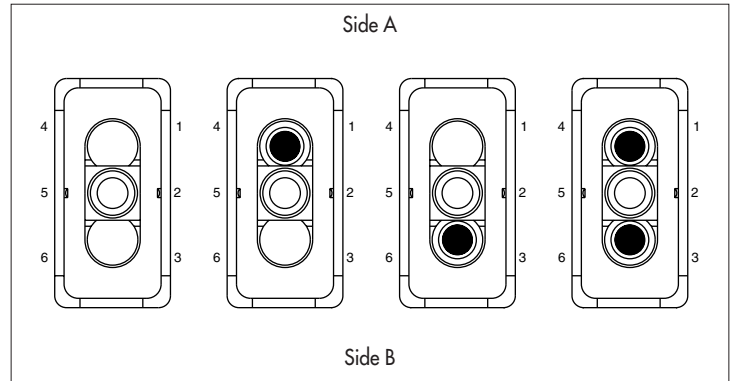

LAMP WIRING

The lamp wiring diagram is shown on the case.

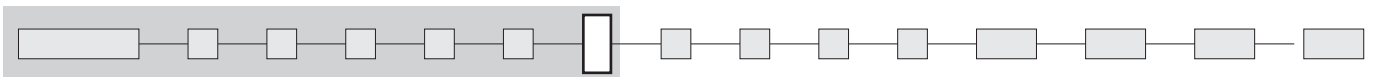

A (standard)

B

C

D - for function 1 (on-off)
with lamp on side A

To order case only (without rocker), finish your order number with the lamp wiring code.

KG series

Power rocker switches

Rockers - lenses

ROCKER COLOUR

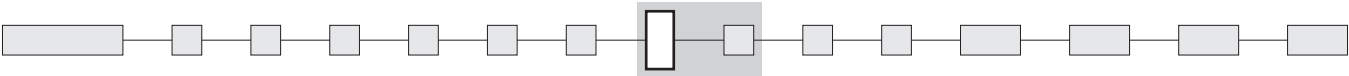

1	Blue
1/4	Dark blue
2	Black
3	Green
4	Grey

5	Yellow
6	Red
7	Ivory
9	Orange

ROCKER SHAPE

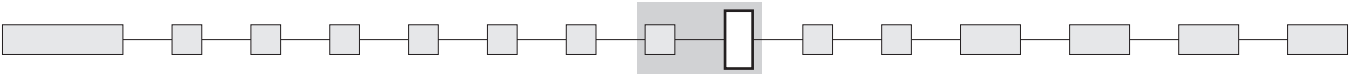

1 Full rocker



4 Opening on side A



6 Opening on side B



8 Opening on sides A and B

Other rocker shapes on customer specifications : on request.

To order rocker only (without case), begin the order number with code KGR, then follow the order format from "rocker colour" until the end of the options.

LENS COLOUR

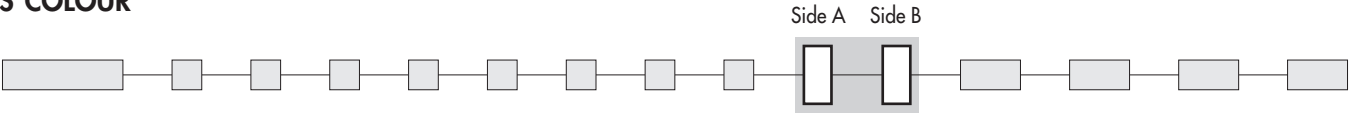

Complete each enlarged box with one of the codes listed below.

X	No lens
1	Blue *
3	Green *
6	Red
9	Orange
B	White
T	Translucent

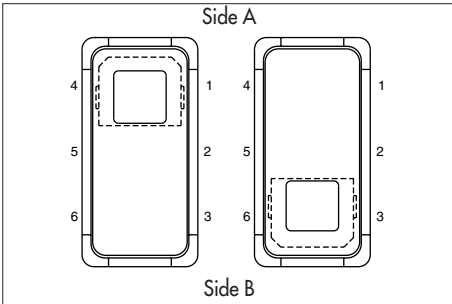
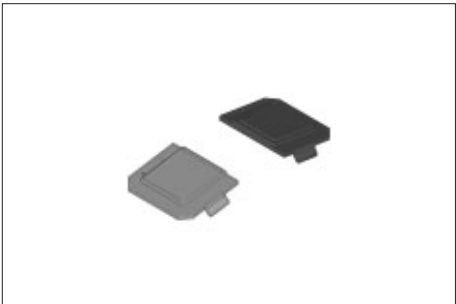

* Blue or green lens recommended with fluorescent lamp.

To order lenses only, begin the order number with the codes :
 KGLA for lens A and KGLB for lens B,
 then follow the order format from "lens colour" until the end of the options.

KG series

Power rocker switches

Marking

MARKING

If no marking required, leave all boxes blank.

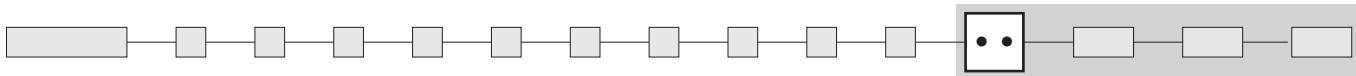

Select one option from each of the tables below.

MARKING METHOD	
L	Laser (on request)
C	Hot stamping

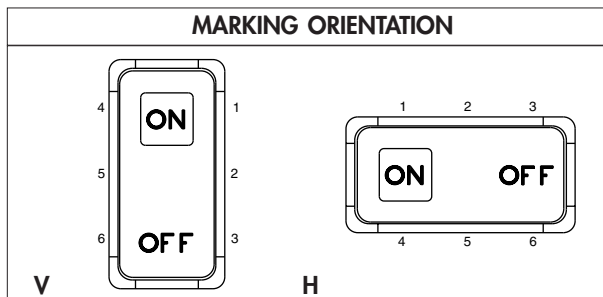

Other orientations :
on request

SYMBOLS

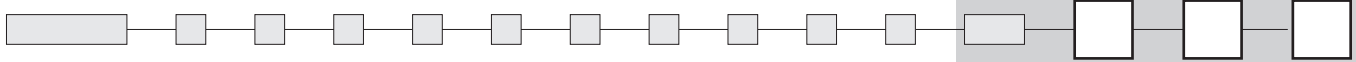

White marking for black rockers - Black marking for colour rockers - Other : on request.
Marking in M area : on request.

CODE	SYMBOL	DESCRIPTION
XX	None	-
01	ON	-
02	OFF	-
03	○	-
04		-
05		-
06	STOP	-
07	A	Stop
08	M	Motion
09	△	Up motion

CODE	SYMBOL	DESCRIPTION
10	▽	Down motion
11	☀	Hot
12	✱	Cold
13	⚠	Hazard lights
14	☀	Traveller lighting
15	☀	Driver lighting
16	☀	Revolving light
17	⚙	Rear ventilator
18	☀	Heating
19	🚪	Door opening

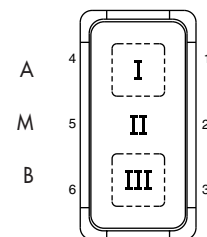

20	☂	2 1	Windshield demister/defroster
21	☂	2 1	Windshield wiper
22	☂		Windshield washer
23	⚙		Ventilator
24	☂		Side mirror defroster
25	⚙		Restarting pump
26	☂		Front fog lights
27	☂		Rear fog lights