

| Part Number* | Relay Description |
|--------------|---|
| KD00CK | 5A Solid-State Relay (SSR) |
| KD02CK | 5A SSR with Switch Status |
| KD20CK | 5A SSR with Short-Circuit Protection |
| KD22CK | 5A SSR with Short-Circuit Protection and Switch Status |
| LD00CM | 10A Solid-State Relay |
| LD02CM | 10A SSR with Switch Status |
| LD20CM | 10A SSR with Short-Circuit Protection |
| LD22CM | 10A SSR with Short-Circuit Protection and Switch Status |

* The Y suffix denotes parameters tested to MIL-PRF-28750 specifications. The W suffix denotes parameters tested to Teledyne specifications.

ELECTRICAL SPECIFICATIONS

(-55°C TO +105°C UNLESS OTHERWISE NOTED)

INPUT (CONTROL) SPECIFICATION

When used in 2 terminal configuration

| (TTL or direct control) (See Fig. 1) | Min | Typ | Max | Units |
|---|-----|-----|-----|-------|
| Input Current @ $V_{BIAS} = 5$ Vdc (See Fig. 2) | | | 15 | mAdc |
| Turn-Off Voltage (Guaranteed Off) | | | 1.5 | Vdc |
| Turn-On Voltage (Guaranteed On) | 3.8 | | | Vdc |
| Reverse Voltage Protection | | | -32 | Vdc |
| Input Supply Range (See Note 1) | 3.8 | | 32 | Vdc |

INPUT (CONTROL) SPECIFICATION

When used in 3 terminal configuration

| (CMOS or open collector TTL) (See Fig. 1) | Min | Typ | Max | Units |
|---|-----|-----|-----|-----------|
| Control Current | | | | |
| $V_{CONTROL} = 5$ Vdc | | | 250 | μ Adc |
| $V_{CONTROL} = 18$ Vdc | | | 1 | mAdc |
| Control Voltage Range | 0 | | 18 | Vdc |
| Bias Supply Voltage (See Note 1) | 3.8 | | 32 | Vdc |
| Bias Supply Current | | | 16 | mAdc |
| Turn-Off Voltage (Guaranteed Off) | 3.2 | | | Vdc |
| Turn-On Voltage (Guaranteed On) | | | 0.3 | Vdc |



FEATURES

- Available with short-circuit/current overload protection
- Available with switch status output
- TTL and CMOS compatible control
- Low ON resistance power FET output
- Fast switching speed
- Meets 28 Vdc system requirements of MIL-STD-704
- Optical isolation
- Low profile hermetic package
- Built and tested to the requirements of MIL-PRF-28750

DESCRIPTION

The Series KD and LD solid-state relays are screened utilizing MIL-PRF-28750 test methods and are packaged in low profile hermetically sealed cases. These relays are constructed with state-of-the-art solid state techniques and feature fully floating power FET output technology. This allows the load to be connected to either output terminal and provides a low ON resistance. The input (control) and output are optically isolated to protect input logic circuits from output transients. Available options include short circuit and current overload protection, which provides complete protection for both the relay and system wiring. This feature not only provides protection should a short or overload occur while the relay is on, but will also provide protection should the relay be switched into a short. The second option is a status output line. Switch status returns the true status of the output switch and is optically isolated from the load. It provides status indication independent of the control circuit of the relay. The status line provides a logic 0 (low) when the relay output is off with load voltage and continuity present, and a logic 1 (high) when the output is on.

OUTPUT (LOAD) SPECIFICATIONS

| (See Note 2) | Min | Typ | Max | Units |
|--|-----|-----------|------|---------|
| Continuous Load Current (See Fig. 3) | | | | |
| KD and LD series without heat sink | | | 5 | A dc |
| LD series with heat sink | | | 10 | A dc |
| Leakage Current @ $V_{LOAD} = 60Vdc$ | | | | |
| KD00CK, KD20CK | | | 100 | μA |
| LD00CM, LD20CM | | | 100 | μA |
| KD02CK, KD22CK | | | 2 | mA |
| LD02CM, LD22CM | | | 2 | mA |
| Output Voltage Drop | | | | |
| KD00CK, KD02CK | | | .60 | Vdc |
| KD20CK, KD22CK | | | .70 | Vdc |
| LD00CM, LD02CM @ 10A | | | 1.2 | Vdc |
| LD20CM, LD22CM @ 10A | | | 1.4 | Vdc |
| Continuous Operating Load Voltage | | | | |
| | | | 60 | Vdc |
| Transient Blocking Voltage @ 25°C | | | | |
| | | | 80 | Vdc |
| ON Resistance, $I_{LOAD} = 100 mA$, $T_J = 25^\circ C$, (See Note 3) | | | | |
| KD00CK, KD02CK | | | .075 | Ohm |
| LD00CM, LD20CM | | | .075 | Ohm |
| KD20CK, KD22CK | | | .100 | Ohm |
| LD20CM, LD22CM | | | .100 | Ohm |
| Turn-On Time (See Fig. 5) | | | | |
| | | | 5 | ms |
| Turn-Off Time (See Fig. 5) | | | | |
| | | | 2 | ms |
| Electrical System Spike @ 25°C | | | | |
| | | ± 600 | | Vpk |
| Output Capacitance at 25 Vdc, 100 KHz | | | | |
| | | | 1600 | pF |
| Isolation (Input to Output) | | | | |
| KD00CK, KD20CK | | | 10 | pF |
| LD00CM, LD20CM | | | 10 | pF |
| KD02CK, KD22CK | | | 15 | pF |
| LD02CM, LD22CM | | | 15 | pF |
| Dielectric Strength | | | | |
| | | 1000 | | Vac |
| Insulation Resistance @ 500 Vdc | | | | |
| | | 10^9 | | Ohms |
| Output Junction Temperature | | | | |
| | | | 130 | °C |
| @ $I_{LOAD} = I_{max rated}$ | | | | |
| Maximum Junction Temperature | | | | |
| | | | 150 | °C |
| Thermal Resistance Junction to Ambient (θ_{JA}) | | | | |
| | | | 30 | °C/W |
| Thermal Resistance Junction to Case (θ_{JC}) | | | | |
| | | | 7 | °C/W |

BLOCK DIAGRAM

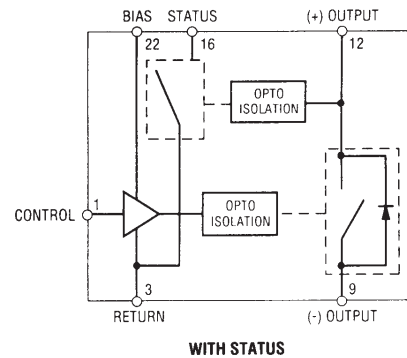

WITH STATUS

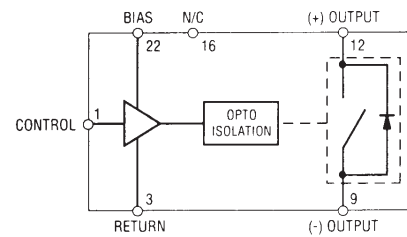

NO STATUS

MECHANICAL SPECIFICATION

DIMENSIONS ARE SHOWN IN INCHES (MILLIMETERS)

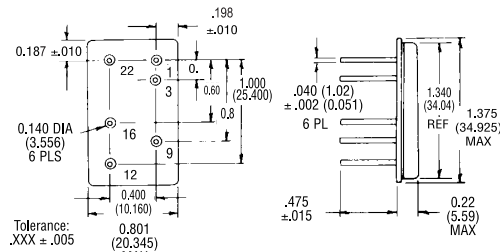

K PACKAGE

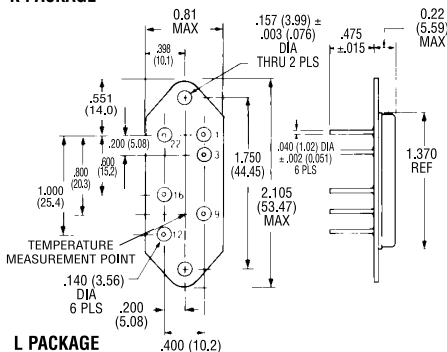

L PACKAGE

- Enclosure: Hermetically Sealed DIP
- Leak Rate: 1×10^{-8} CC/Sec Maximum
- Material: Header: Cold Rolled Steel
Nicksel Plated
Copper Core
- Pins: Grade A Nickel
- Can: Grade A Nickel
- Weight: 20 grams
- Tolerance: .XXX ± .005

ENVIRONMENTAL SPECIFICATIONS

| | Min | Typ | Max | Units |
|-----------------------|-----|-----|------|-------|
| Temperature Range | | | | |
| Operating | -55 | | +105 | °C |
| Storage | -55 | | +125 | °C |
| Vibration 100 g | 10 | | 3000 | Hz |
| Constant Acceleration | | | 5000 | g |
| Shock 0.5 ms pulse | | | 1500 | g |

**STATUS OUTPUT TRUTH TABLE
(KD02CK, LD02CM, KD22CK, LD22CM)**

| Control Voltage | Relay Output | State Status Output Level |
|-----------------|--------------|----------------------------------|
| High | Off | Low ($V_{SO} \leq 0.4 V_{dc}$) |
| Low | On | High ($V_{SO} = V_{STATUS}$) |

**STATUS OUTPUT SPECIFICATIONS
(KD02CK, LD02CM, KD22CK, LD22CM)**

| | Min | Typ | Max | Units |
|---|-----|-----|-----|-------|
| Status Supply Voltage | | | 30 | Vdc |
| Status Leakage Current | | | | |
| @16Vdc | | | 10 | µAdc |
| @30Vdc | | | 100 | µAdc |
| Status (sink) Current ($V_{SO} < 0.4 V_{dc}$) | | | 600 | µAdc |
| Status Turn-On Time (See Fig. 6) | | | 3.5 | ms |
| Status Turn-Off Time (See Fig. 6) | | | 8.0 | ms |

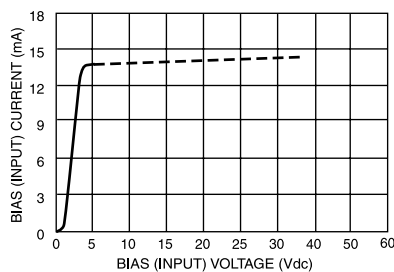

**BIAS (INPUT) CURRENT VS BIAS (INPUT) VOLTAGE
FIGURE 2 (See Note 1)**



(A) 3 TERMINAL INPUT WITH STATUS (See Note 5)

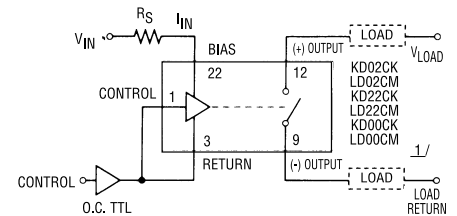

(B) 2 TERMINAL INPUT (OPEN COLLECTOR TTL DRIVE)

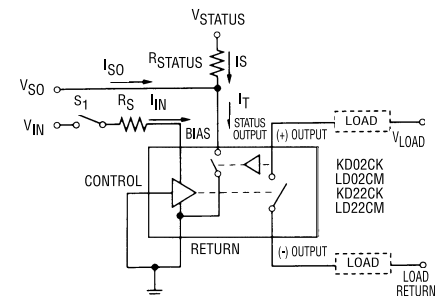

(C) 2 TERMINAL INPUT (DIRECT DRIVE) WITH STATUS

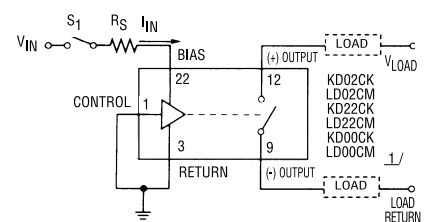

(D) 2 TERMINAL INPUT (DIRECT DRIVE)

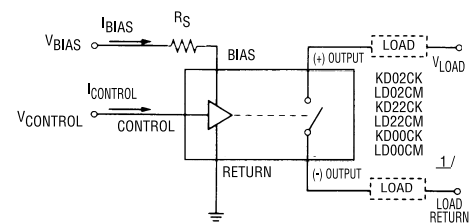

1/ KD02CK, KD22CK, LD02CM and LD22CM may be wired without the status line as shown in (B), (D) and (E) above.

(E) 3 TERMINAL INPUT WITHOUT STATUS

**WIRING CONFIGURATIONS
FIGURE 1 (See Note 1)**



LOAD CURRENT DERATING CURVE FOR KD/LD SERIES WITHOUT A HEAT SINK (A)

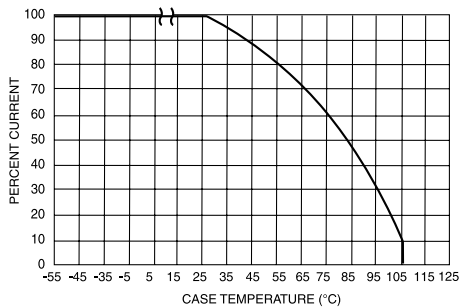

LOAD CURRENT DERATING CURVE FOR LD SERIES (B)

THERMAL DERATING CURVES FIGURE 3

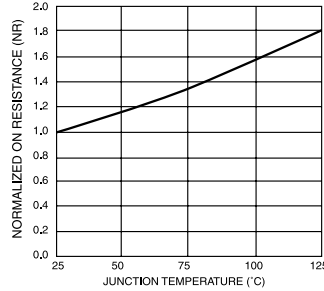

NORMALIZED ON RESISTANCE VS JUNCTION TEMPERATURE FIGURE 4 (See Note 3)

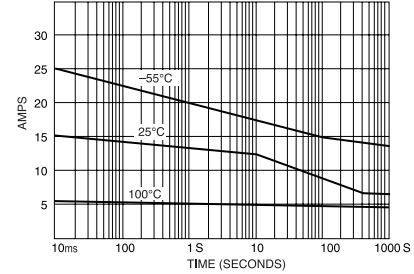

OVERLOAD CURRENT VS TIME TO TRIP (TYPICAL) KD20CK, KD22CK, LD20CM, LD22CM FIGURE 7

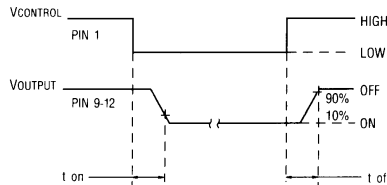

OUTPUT TURN-ON AND TURN-OFF TIMING FIGURE 5

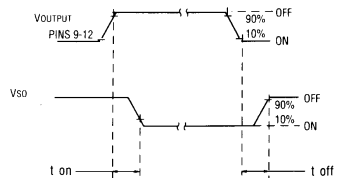

STATUS TURN-ON AND TURN-OFF TIMING FIGURE 6

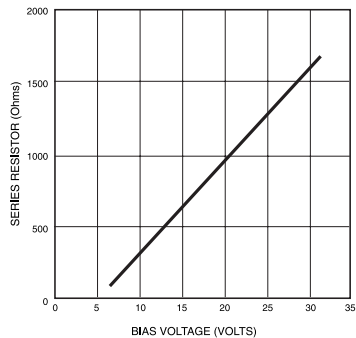

SERIES LIMIT BIAS RESISTOR VS BIAS VOLTAGE FIGURE 8 (See Note 1)

NOTES:

- Control input is compatible with CMOS or open collector TTL (with pull up resistor). For bias voltages above 6V, a series resistor is required. Use the standard resistor value equal to or less than the value found in Figure 8.
- The rated input voltage is 5V for all tests unless otherwise specified.
- To calculate the maximum ON resistance for a given junction temperature, find the normalized ON resistance factor (NR) from Figure 4. Calculate the new ON resistance as follows:

$$R_{(ON)} = NR \cdot R_{ON} @ 25^{\circ}C$$

$$R_{(ON)} = NR(R_{ON} @ +25^{\circ}C) + .025 \text{ ohm}$$
 (KD00CK, LD00CM, KD02CK, LD02CM)
 (KD20CK, LD20CM, KD22CK, LD22CM)
- Overload testing to the requirements of MIL-PRF-28750 is constrained to the limits imposed by the short circuit protection characteristics as defined in this specification. System series inductance for "shorted-load" mode of operation should be 50 μH. Maximum repetition rate into a shorted load should not exceed 10 Hz.
- A status pull up resistor is required for proper operation of the status output. Determine the current (I_{so}) required by the status interface. Calculate the current (I_s) through the status resistor such that the sink current through the status output is 0.6 mA. Select the status resistor such that it does not allow more than 0.6 mA to flow through the status output.

$$R_{STATUS} = \frac{V_{STATUS} - 0.4V}{I_{so}}$$

- Inductive loads should be diode suppressed. Input transitions should be ≤1 ms duration and the input drive should be a bounceless contact type.

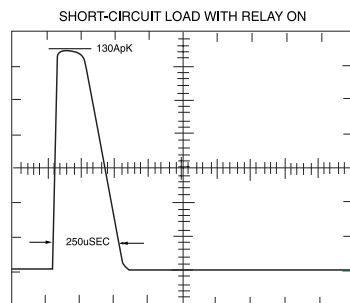
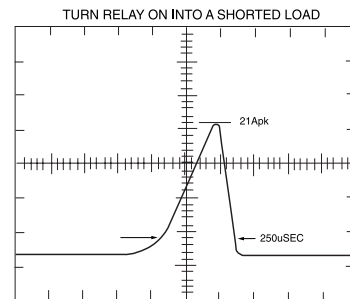

TYPICAL TRIP CURRENT CHARACTERISTICS FOR SHORT CIRCUIT CONDITIONS FIGURE 9