

SERIES KAJ SWITCHES

LOW-PROFILE DIP SWITCHES

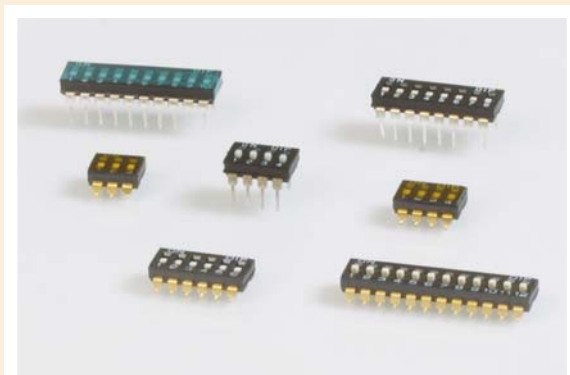

SPECIFICATIONS

Switch Function:	2, 3, 4, 5, 6, 7, 8, 9, 10 & 12 positions
Ratings:	Switch: 25mA @ 24 VDC Carry: 100mA @ 50 VDC
Contact Resistance:	initial 50mΩ typical @ 2-4 VCD, 100mA
Insulation Resistance:	100 MΩ min.
Operating Life:	2,000 cycles, typical
Dielectric Strength:	500 V rms @ sea level between adjacent terminals
Temperature Range:	-40° C to 85° C

FEATURES & BENEFITS

- ▶ Available in SMT or Thru Hole
- ▶ Tape & reel or tube packaging
- ▶ Up to 12 positions

APPLICATIONS/MARKETS

- ▶ Garage door openers
- ▶ Test & instrumentation
- ▶ Telecommunications
- ▶ Controller application

TYPICAL SMT TEMPERATURE PROFILE

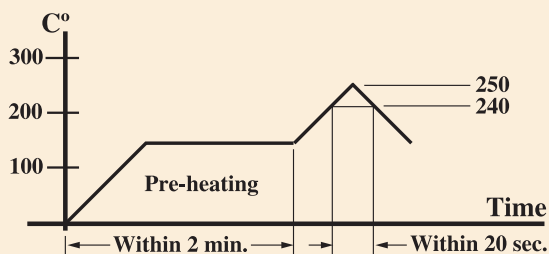

MATERIALS

Base:	PPS UL94 V0, black finish
Cover:	PPS UL94 V0, black finish
Actuator:	Nylon UL94 V0, white finish
Movable Contact:	Gold-plated copper alloy
Terminal Contact:	Gold-plated brass
Tape Seal:	Mylar, amber color

PACKAGING

Switches are supplied in standard IC tubes with all poles in the "OFF" position.

HOW TO ORDER

SERIES	MODEL NO.	NO. OF POSITIONS	ACTUATOR	TERMINATION	TERMINAL FINISH	PACKAGING
KA	J = Low Profile	02 = 2 03 = 3 04 = 4 05 = 5 06 = 6 07 = 7 08 = 8 09 = 9 10 = 10 12 = 12	L = Extended S = Recessed w/o Tape Seal T = Recessed w/ Tape Seal	A = Splayed Pins H = Straight Pins G = Gull Wing	G = Gold	T = Std. Tube R = Tape and Reel

▶ ▶ ▶ Example Ordering Number
KA-J-02-S-A-G-T

Specifications subject to change without notice.



SERIES KAJ SWITCHES

LOW-PROFILE DIP SWITCHES

TERMINATION & PIN SPACING OPTIONS

TACT SWITCHES

NAVIGATION SWITCHES

PUSHBUTTON SWITCHES

TOGGLE SWITCHES

ROCKER SWITCHES

SLIDE SWITCHES

SNAP-ACTION SWITCHES

DIP SWITCHES

KEYLOCK SWITCHES

ROTARY SWITCHES

DETECTOR SWITCHES

CAP OPTIONS

KAJ

STRAIGHT (FOR MANUAL INSERTION)

H 7.62mm SPACING

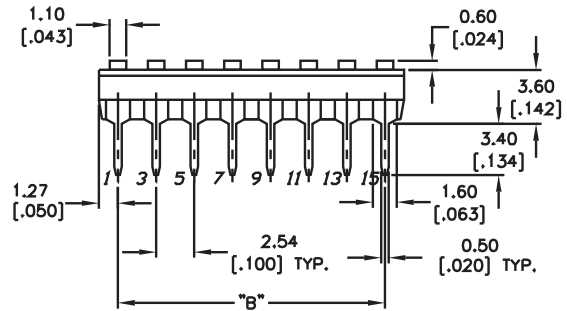
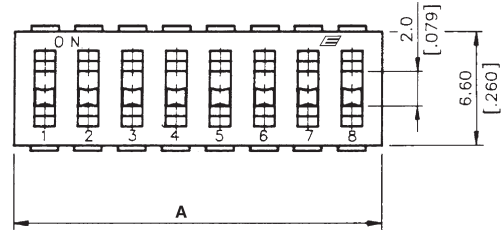
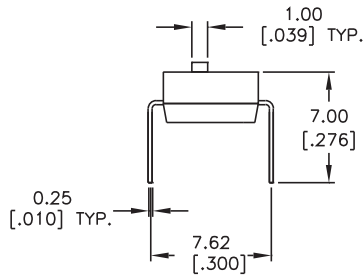

KAJ

SPLAY (FOR IC MACHINE INSERTION)

A 9.84mm SPACING

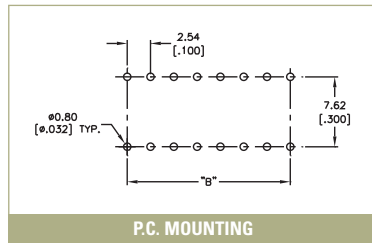
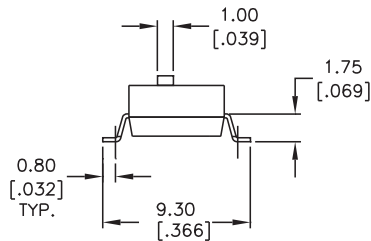
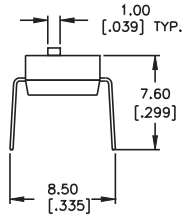

PC MOUNTING

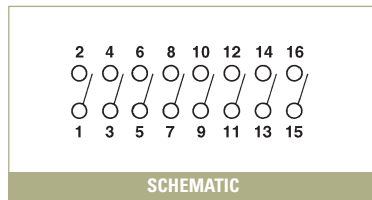

SCHEMATIC

KAJ

G GULL WING

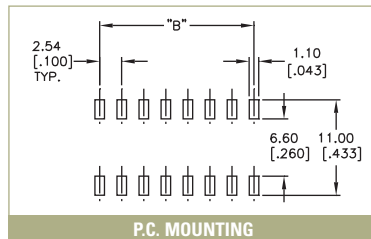
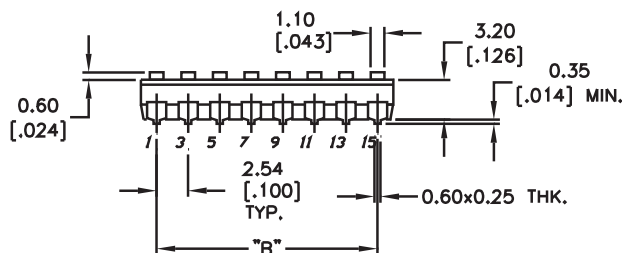
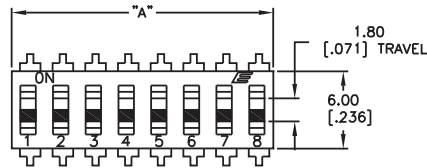

PC MOUNTING

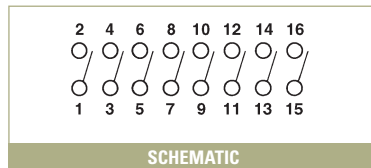

SCHEMATIC

ACTUATOR OPTIONS

S RECESSED

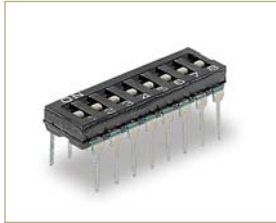

L EXTENDED

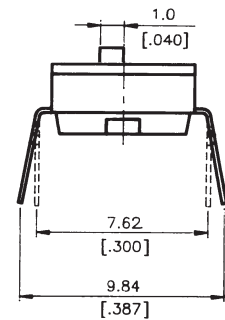
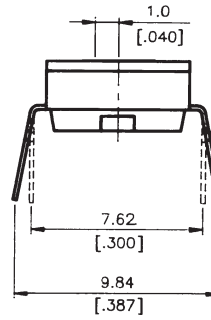
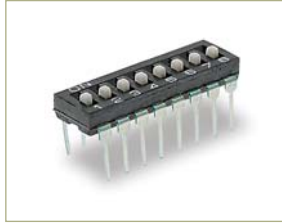

PACKAGING & SEAL OPTIONS

T TOP TAPE SEALED

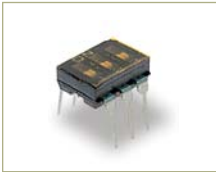

*Top Tape Seal for Recessed Actuator only.

R TAPE AND REEL WITH TOP TAPE SEAL

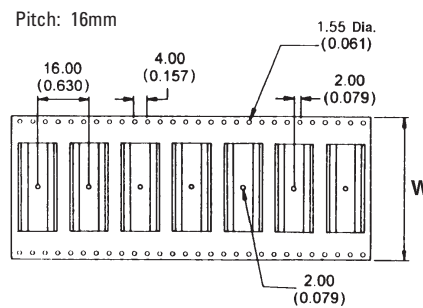
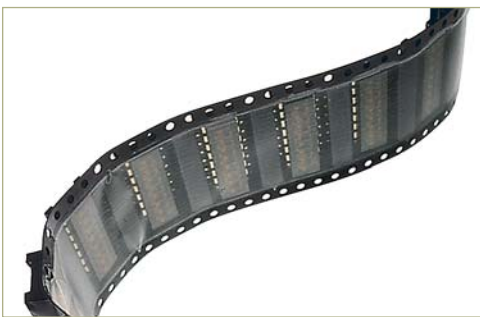

Pos.	TapeSize (W)
2	16mm
3	16mm
4	24mm
5	24mm
6	24mm
7	32mm
8	32mm
9	44mm
10	44mm
12	44mm

TACT SWITCHES

NAVIGATION SWITCHES

PUSHBUTTON SWITCHES

TOGGLE SWITCHES

ROCKER SWITCHES

SLIDE SWITCHES

SNAP-ACTION SWITCHES

DIP SWITCHES

KEYLOCK SWITCHES

ROTARY SWITCHES

DETECTOR SWITCHES

CAP OPTIONS