



Plastic Push-Pull Coupling Mechanism

Connectors for Medical Applications



Contents

Overview

Typical applications	06
Features & Benefits	07
Reliable people, reliable solutions	08
Range overview	09
Layouts	10
General technical characteristics	11
Color codings	12
Part numbering information	13

Connector

Overmolded cable assembly	16
2 contacts	18
3 contacts	22
4 contacts	26
5 contacts	30
6 contacts	34
7 contacts	38
8 contacts	42
10 contacts	46
12 contacts	50

Contacts

Description	56
Packaging	56
Solder contacts	57
Crimp contacts	58
Straight PC tail contacts	59
90° PC tail contacts	60
Tooling	61

Technical Information

Receptacle assembly instructions	64
Plug assembly instructions	65
Which Standard to select ?	66
UL94 + UL1977	67
IEC 61984 & IP codes explained	70
What is NEMA rating ?	72
What is CE marking ?	72
Sterilization	73
Ethernet for the Layman	74

Appendices

Glossary of terms	78
Safety notice	79
Part number index	80

JMX SERIES

Overview

■ Typical applications	06
■ Features & Benefits	07
■ Reliable People, Reliable Solutions	08
■ Range overview	09
■ Layouts	10
■ General technical characteristics	11
■ Color codings	12
■ Part numbering information	13

Typical applications



Physio & Medical Therapy



Patient Monitoring



Diagnostic Device & Imaging



Surgical & Dental Systems - Instrumentation



Laboratory Equipment



Features & Benefits

**EASY
AND
SAFE**

Reliable mating: Push-Pull Locking Mechanism

Only requires two fingers to mate/unmate securely with an audible and tactile indicator. Capable of mating over 2,000 times. Keyings and color identifications are available to avoid accidental system mating errors.

**PROTECT
YOUR
EQUIPMENT**

Waterproof: IP68 in Mated and/or Unmated Condition

JMX Series will protect your equipment from fluid ingress and liquid projection.

**STERILI-
ZATION**

Adapted for the Medical Market

Withstand to autoclave steam sterilization with pre-vacuum and gravity displacement process per IEC 60601. 200 autoclave cycles at 134°C (273°F).

**AESTHETIC
EQUIPMENT**

Designed for an Aesthetic Equipment Design

An attractive, appealing and ergonomic connector to fit with all medical equipment designs.

**MAKE
LIFE
EASIER**

UL/IEC Compliant

In accordance with UL 1977 and IEC 61984: a compliance making your equipment qualification easier.

We have thought of everything...



Rubber sealing gland



Compound



Waterproof – IP68

- A rubber gland certifying the sealing between the cable and the plug
- Compound on solder receptacles ensuring the IP68 in unmated condition



A Full Solution Offering (see page 16)

- IP68 and Overmolded Cable Assembly solutions available in standard or custom designs
- Withstands autoclave process

A Reinforced Traceability

- A date code (Year - Week) available on the plug and receptacle to ensure full traceability
- Not visible once installed



Ergonomic / Aesthetic design

- An instinctive feeling design with your fingers
- Keying and color identification to help avoid accidental mating errors
- Attractive and appealing design to fit with all medical equipment

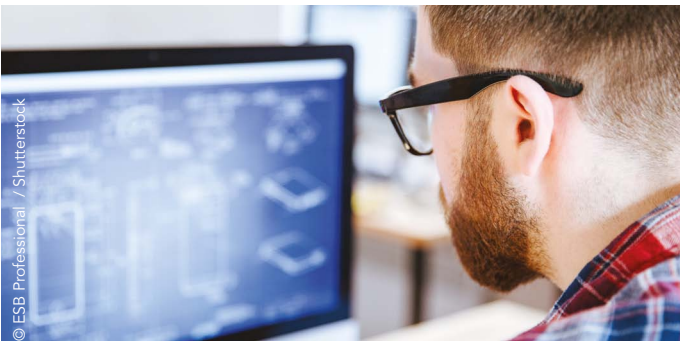

Flexibility & Availability

- Worldwide distribution network ensuring full availability and logistical support
- Customized interconnect solutions
- A dedicated team available for technical support, training and engineering collaboration
- An integrated and certified laboratory to perform tests and qualifications

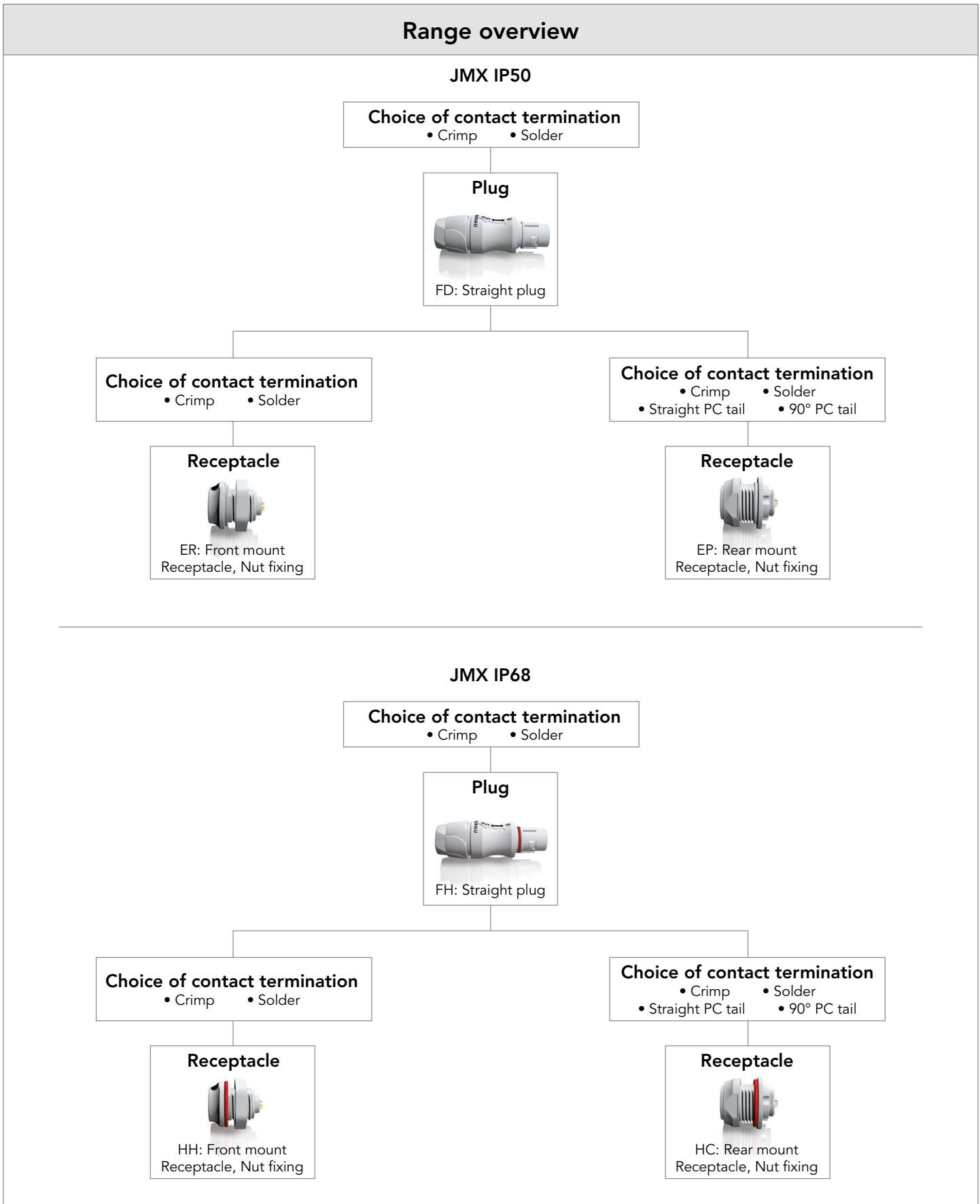

Layouts

Voltages shown below are Test Voltages measured according to the IEC 60512-2 test 4a. Test voltage corresponds to 75% of the mean dielectric withstanding voltage. Operating voltage could be calculated following the method: $\frac{\text{Test Voltage}}{3}$







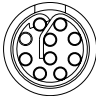

Please refer to the connector section for the UL and IEC voltage values.

Contacts Ø 0.5mm / Ø 0.019"
Solder Wire: AWG 28 and smaller
Crimp Wire: Not available

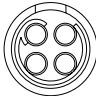
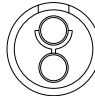
Contacts Ø 0.7mm / Ø 0.027"
Solder Wire: AWG 22 and smaller
Crimp Wire: AWG 22 - 24 - 26

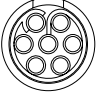
Contacts Ø 0.9mm / Ø 0.035"
Solder Wire: AWG 22 and smaller
Crimp Wire: AWG 20 - 22 - 24

Contacts Ø 1.3mm / Ø 0.051"
Solder Wire: AWG 20 and smaller
Crimp Wire: AWG 18 - 20 - 22



Shell size	Contact Ø 0.5 mm	Contact Ø 0.7 mm	Contact Ø 0.9 mm	Contact Ø 1.3 mm
1	<p>10 contacts 2.5A 900V AC/CD mini: 0.58 mm</p>  <p>Page 46</p>	<p>6 contacts 6A 1,000V AC/CD mini: 0.75 mm</p>  <p>Page 34</p>	<p>4 contacts 8A 1,100V AC/CD mini: 1.00 mm</p>  <p>Page 26</p>	<p>2 contacts 10A 1,200V AC/CD mini: 1.20 mm</p>  <p>Page 18</p>
	<p>12 contacts 2.5A 900V AC/CD mini: 0.59 mm</p>  <p>Page 50</p>	<p>7 contacts 5A 1,000V AC/CD mini: 0.75 mm</p>  <p>Page 38</p>	<p>5 contacts 7A 1,100V AC/CD mini: 0.80 mm</p>  <p>Page 30</p>	<p>3 contacts 9A 1,100V AC/CD mini: 1.00 mm</p>  <p>Page 22</p>
			<p>8 contacts 5A 900V AC/CD mini: 0.54 mm</p>  <p>Page 42</p>	

Note: AC/CD mini means minimum "Air Clearance" or "Creepage Distance".

General technical characteristics



Materials

- Shell: PEI
- Insert: PEEK
- Collet: PEI
- Cable seal: Silicon rubber
- Clip: Beryllium copper
- Contacts: Cupro-Nickel
- Contacts plating: Gold
- RoHS compliant 
- REACH compliant 
- Biocompatibility:
Shell material biocompatible to USP Class VI / ISO 10993

Environmental

- Operating temperature:
 - Receptacle: -20°C +100°C / -4°F +212°F
 - Plug: -40°C +125°C / -40°F +257°F
 - Short term (autoclaving): Resistance up to +134°C / 273.2°F
- Flammability rating:
UL94 V-0 for the shell
UL94 HB for the insert
- Steam sterilization*:
Plug withstands autoclave steam sterilization pre-vacuum & gravity displacement process: 200 cycles per EN13060

- Sealing (if used with the appropriate cable dimension):

	Mated conditions (Plug + receptacle)	Unmated conditions		
		Plug	Receptacle with solder contacts	Receptacle with crimp contacts
IP50	IP50	IP50	IP50	IP50
IP68*	IP68	IP50	IP68	IP50

*IP68 (1 bar during 1 week) per IEC60529

- IP68 in un-mated conditions are identified with the symbol "☂" into the connector section.

- Fluid resistance:

- Isopropyl alcohol
- Ethanol
- Sodium Hypochlorite
- Korsolex Extra
- Gigasept FF
- Incidur
- Sekusept Plus
- Sani Cloth active

Please consult us for other fluid resistance request

Mechanical

- Durability:
> 2,000 cycles per IEC 60512-5 test 9a
- Mechanical strength impact:
Dropping height 750 mm /29.527" per IEC 60512-7-2 test 7b
- Color coding:
5 color codings. Please refer to the page 12 and the connector section

- Discrimination/Keying Method:

Please refer to the page 12

- Acceptable cable diameter:

3.5 mm to 7.5 mm, 0.137" to 0.295"

- Traction on the cable:

In mated condition	
Traction by pulling on the cable of the plug without using the uncoupling system	
Average value 100N	
Method IEC 60512-8 Test 15f	

In unmated condition	
Traction by pulling on the cable of the plug	
Max 150 N Depends on the cable	
Method IEC 60512-9 Test 17c	

Electrical

- Compliant to UL 1977 and IEC 61984

- Also see page 10

*Connectors are not sterilized when shipping to the customer. The medical device manufacturer is in charge of cleaning the connectors to ensure an appropriate use in the final application.

Discrimination / Color coding







In applications where similar connectors are used next to each other, mismatching can cause disturbances, system failures or even danger to operating personnel.

To eliminate mismatching, JMX connectors are offered with discrimination keys to avoid interconnection system errors.

In addition to the keyings, SOURIAU offers 5 color codings on receptacle and plug to help the user to identify the correct connector. Each color is linked to a polarization key. Below you will find the correlation table.

JMX color identification remains visible in mated condition.

Color	No color identification	Blue	Red	Green	Orange	Yellow
						
Coding	G	A	B	C	D	E
Part number	JMX***G***UDSU	JMX**A***UDSA	JMX**B***UDSR	JMX**C***UDSV	JMX**D***UDSO	JMX**E***UDSJ

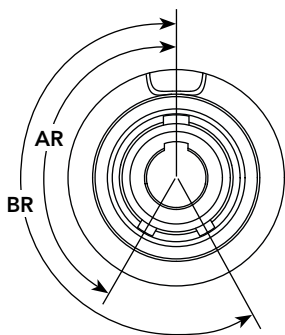

Viewed from front face receptacle

Correlation table		
Position	AR	BR
G	165°	195°
A	45°	180°
B	135°	225°
C	45°	225°
D	135°	315°
E	180°	315°

G is the standard keying. Other keyings can be ordered by replacing the G character by the needed keying. JMXHH1G03MSUDSU (G keying) => JMXHH1B03MSUDSR (B keying Red color)

Part numbering information

Basic Series	JMX	FH	1	G	02	M	S	UDS	U
Shell type:									
FH	Straight Plug IP68								
FD	Straight Plug IP50								
HH	Front Mount receptacle IP68								
HC	Rear Mount receptacle IP68								
ER	Front Mount receptacle IP50								
EP	Rear Mount receptacle IP50								
Shell size									
Keying: A, B, C, D, E, G - see table page 12									
Layout: See table page 10									
Gender:									
M	Male								
F	Female								
Contact termination:									
S	Solder								
C	Crimp								
P	Straight PC tail (Only for receptacle)								
Q	90° PC tail (Only for rear mount receptacle)								
Material: PEI									
Color Identification: see table page 12									
U	No color identification								
A	Blue								
R	Red								
V	Green								
O	Orange								
J	Jaune								

Please note that this table is shown for information only. All the available part numbers are notified in the "Connector section" on p** and Index p**.

JMX SERIES

JMX Series

Connector

■ Overmolded cable assembly	16
■ 2 contacts	
JMX1-02: 10A 1,200V	18
■ 3 contacts	
JMX1-03: 9A 1,100V	22
■ 4 contacts	
JMX1-04: 8A 1,100V	26
■ 5 contacts	
JMX1-05: 7A 1,100V	30
■ 6 contacts	
JMX1-06: 6A 1,000V	34
■ 7 contacts	
JMX1-07: 5A 1,000V	38
■ 8 contacts	
JMX1-08: 5A 900V	42
■ 10 contacts	
JMX1-10: 2.5A 900V	46
■ 12 contacts	
JMX1-12: 2.5A 900V	50

Overmolded cable assembly

SOURIAU has provided connectors for various applications for more than 90 years and has been used in the most extreme environments. Conscious about the difficulty in finding a quick and reliable harness manufacturer, we developed our own in-house overmolded cable assembly production. It allows customers to reduce the number of suppliers and to take advantage of the “best in class” quality of the SOURIAU group. Overmolding is a process that further enhances the sealing properties and helps to minimize stress on the cable termination to the connector. In addition, the wires are encapsulated inside the molding which creates a barrier preventing liquid/moisture from entering the equipment through the connector or cable jacket if breached.



General technical characteristics

Materials

- **Connector**
 - **Shell:** PEI
 - **Insert:** PEEK
 - **Contacts:** see layout pages
- **Cable:**
 - **Insulation conductor type:** FEP
 - **600V**
 - **RoHS compliant** 

Environmental

- **Operating temperature:**
 - From -20°C to +80°C / -4 °F to 176 °F
 - **Sealing:**
 - IP65 in unmated condition
 - IP68 in mated condition
- Please consult us for overmolding solution requests.

Mechanical

- **Durability:**
 - > 2,000 cycles

JMX overmolded cable assembly

Overmolding description

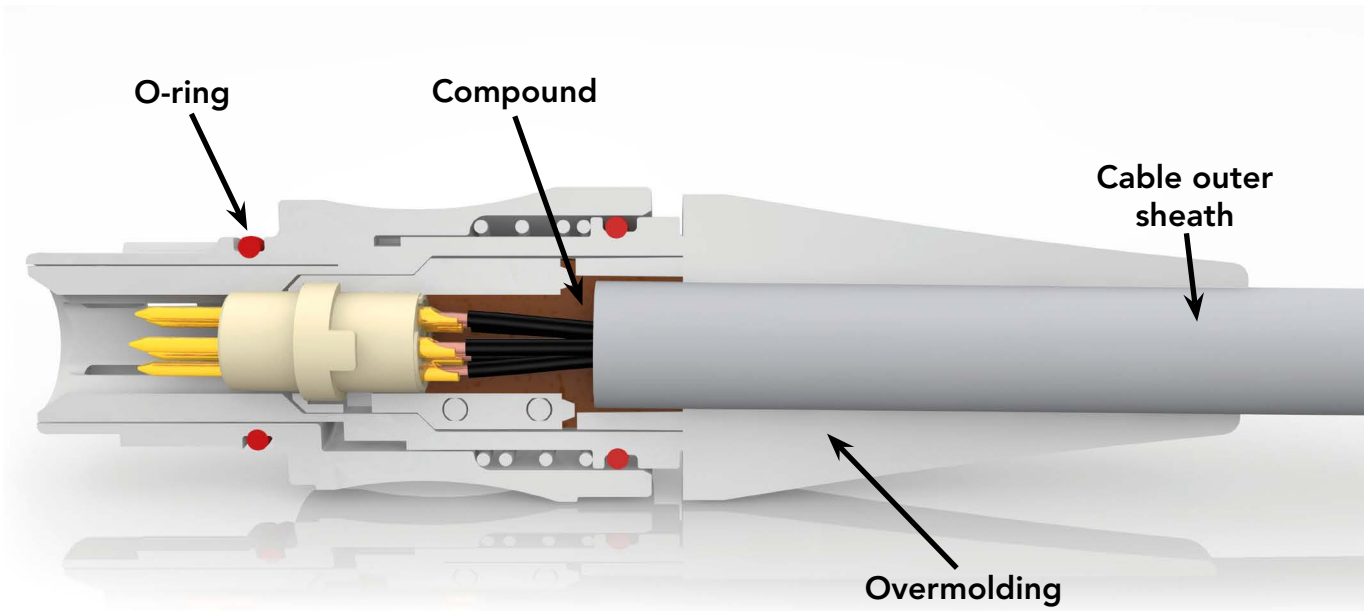

Connector

Connector with cable gland backshell

GOOD

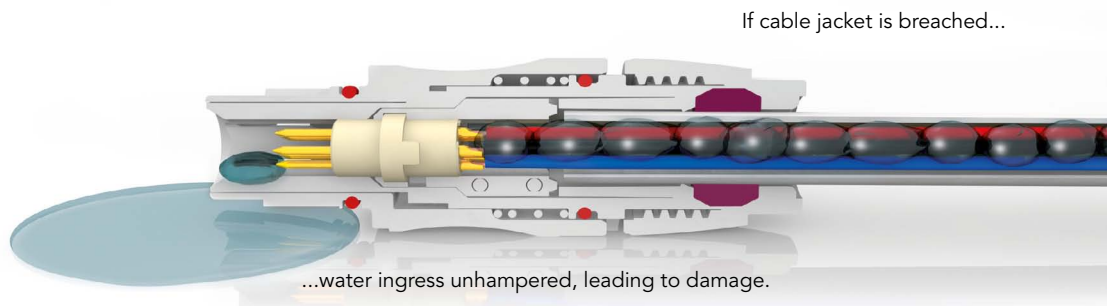

Overmolded connector



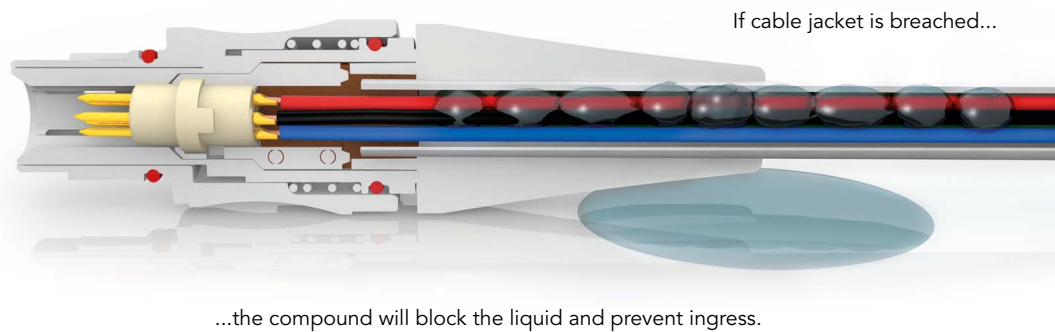

BEST

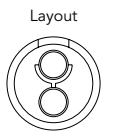

JMX1-02 (2 x Ø 1.3 mm / 2 x Ø 0.051")



Connector part number (Products without color coding)

Sealing	Contact type	Connector type	Description	Part number		
				Male insert	Female insert	
IP68	Solder contacts see page 21	Receptacle	Front mount, nut fixing (HH) 	JMXHH1G02MSUDSU	JMXHH1G02FSUDSU	
			Rear Mount, nut fixing (HC) 	JMXHC1G02MSUDSU	JMXHC1G02FSUDSU	
	Crimp contacts see page 21	Receptacle	Front mount, nut fixing (HH)	JMXHH1G02MCUDSU	JMXHH1G02FCUDSU	
			Rear Mount, nut fixing (HC)	JMXHC1G02MCUDSU	JMXHC1G02FCUDSU	
		Plug	Straight plug (FH)		JMXFH1G02MSUDSU	JMXFH1G02FSUDSU
			Straight plug (FH)		JMXFH1G02MCUDSU	JMXFH1G02FCUDSU
Straight PC Tail see page 59	Receptacle	Rear Mount, nut fixing (HC) 	Please consult us	JMXHC1G02FPUDSU		
90° PC Tail see page 60	Receptacle	Rear Mount, nut fixing (HC) 	Please consult us	JMXHC1G02FQUDSU		
IP50	Solder contacts see page 21	Receptacle	Front mount, nut fixing (ER)	JMXER1G02MSUDSU	JMXER1G02FSUDSU	
			Rear Mount, nut fixing (EP)	JMXEP1G02MSUDSU	JMXEP1G02FSUDSU	
	Crimp contacts see page 21	Receptacle	Front mount, nut fixing (ER)	JMXER1G02MCUDSU	JMXER1G02FCUDSU	
			Rear Mount, nut fixing (EP)	JMXEP1G02MCUDSU	JMXEP1G02FCUDSU	
		Plug	Straight plug (FD)		JMXFD1G02MSUDSU	JMXFD1G02FSUDSU
			Straight plug (FD)		JMXFD1G02MCUDSU	JMXFD1G02FCUDSU
Straight PC Tail see page 59	Receptacle	Rear Mount, nut fixing (EP)	Please consult us	JMXEP1G02FPUDSU		
90° PC Tail see page 60	Receptacle	Rear Mount, nut fixing (EP)	Please consult us	JMXEP1G02FQUDSU		

 : Sealed in Unmated Condition

 : Preferred part numbers with shorter leadtimes

JMX Series | Connector

JMX1-02 (2 x Ø 1.3 mm / 2 x Ø 0.051")

Dimensions (For mated connector lengths see page 21)

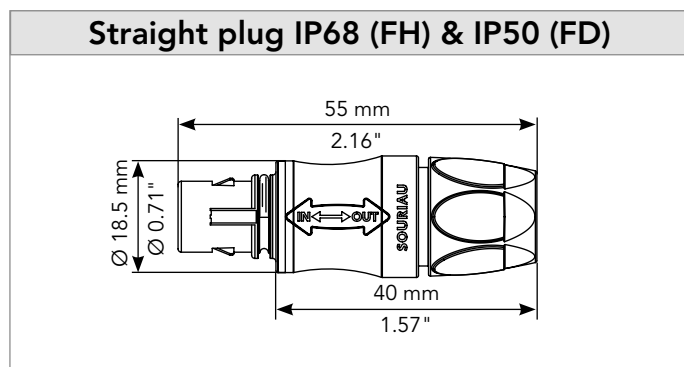
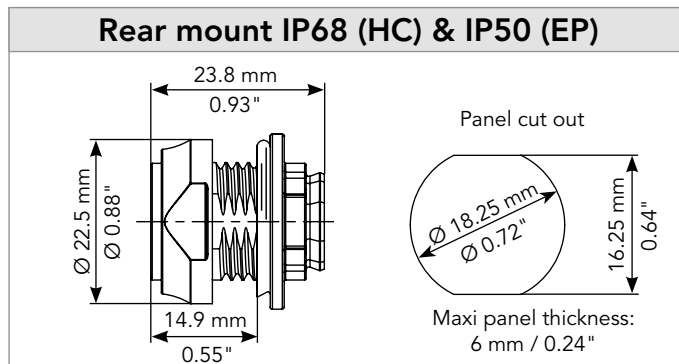
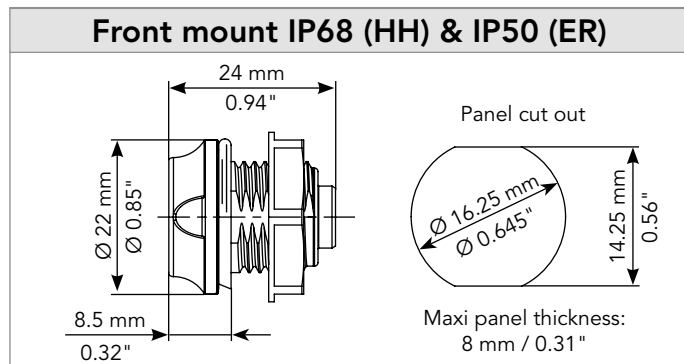

Connector color coding

Coding	Color	Part number ⁽¹⁾					
		Receptacle IP68		Receptacle IP50		Plug IP68	Plug IP50
		Front mount	Rear mount	Front mount	Rear mount	Straight	Straight
G	None	JMXHH1G02**UDSU	JMXHC1G**UDSU	JMXER1G02**UDSU	JMXEP1G02**UDSU	JMXFD1G02**UDSU	JMXFH1G02**UDSU
A	Blue	JMXHH1A02**UDSA	JMXHC1A02**UDSA	JMXER1A02**UDSA	JMXEP1A02**UDSA	JMXFD1A02**UDSA	JMXFH1A02**UDSA
B	Red	JMXHH1B02**UDSR	JMXHC1B02**UDSR	JMXER1B02**UDSR	JMXEP1B02**UDSR	JMXFD1B02**UDSR	JMXFH1B02**UDSR
C	Green	JMXHH1C02**UDSV	JMXHC1C02**UDSV	JMXER1C02**UDSV	JMXEP1C02**UDSV	JMXFD1C02**UDSV	JMXFH1C02**UDSV
D	Orange	JMXHH1D02**UDSO	JMXHC1D02**UDSO	JMXER1D02**UDSO	JMXEP1D02**UDSO	JMXFD1D02**UDSO	JMXFH1D02**UDSO
E	Yellow	JMXHH1E02**UDSJ	JMXHC1E02**UDSJ	JMXER1E02**UDSJ	JMXEP1E02**UDSJ	JMXFD1E02**UDSJ	JMXFH1E02**UDSJ

"**": Gender / Termination

JMX1-02 (2 x Ø 1.3 mm / 2 x Ø 0.051")

Accessories

Receptacle dust cap



Part number
JMXBR1

Plug dust cap

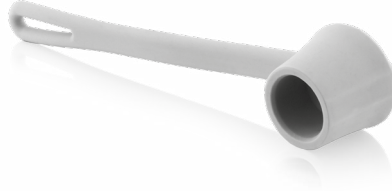

Part number
JMXBF1

Tooling for crimp contacts

Crimp tooling



Part number
M22520/7-01

Locator



Part number	
Male	Female
JBX10UTLP13	JBX10UTLS13

Extraction tool



Part number
JBXOUTDC13

JMX1-02 (2 x Ø 1.3 mm / 2 x Ø 0.051")

Contacts

Ø 1.3 mm / Ø 0.051"	Contact type	Plating	Contact locking type	AWG
Solder	Machined	0.5 µm gold over 3 to 5 µm Ni	Removable on plugs	20 and smaller
Crimp	Machined	0.5 µm gold over 3 to 5 µm Ni	Removable	18 - 20 - 22

For more information see pages 57 to 58

Mated connector length

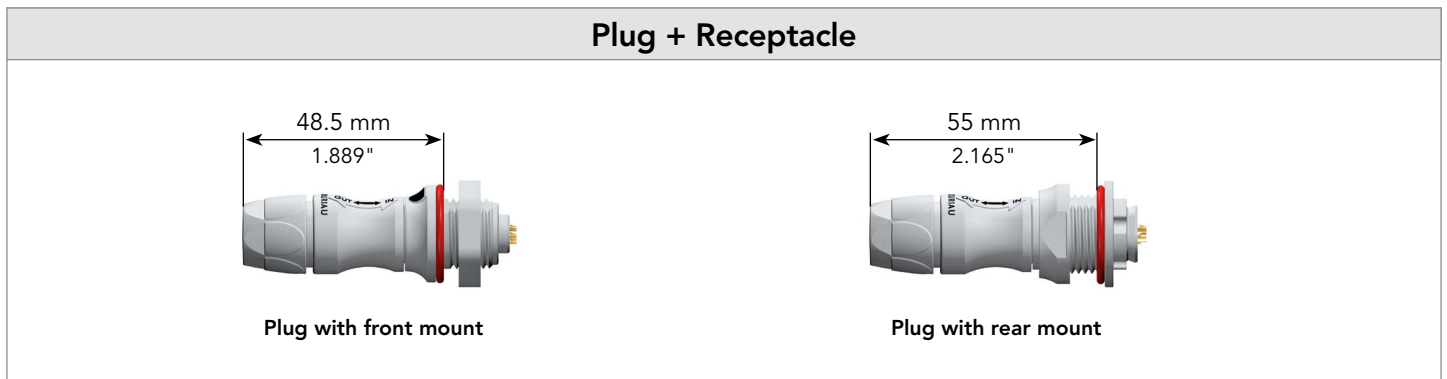



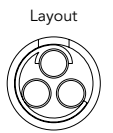

IEC / UL characteristics	
<p>IEC 10A 840 Vdc 1.5 kV 2</p>	<p>UL 10A 300V UL94 HB</p>

JMX1-03 (3 x Ø 1.3 mm / 3 x Ø 0.051")



Connector part number (Products without color coding)

Sealing	Contact type	Connector type	Description	Part number		
				Male insert	Female insert	
IP68	Solder contacts see page 25	Receptacle	Front mount, nut fixing (HH) 	JMXHH1G03MSUDSU	JMXHH1G03FSUDSU	
			Rear Mount, nut fixing (HC) 	JMXHC1G03MSUDSU	JMXHC1G03FSUDSU	
	Solder contacts see page 25	Plug	Straight plug (FH)		JMXFH1G03MSUDSU	JMXFH1G03FSUDSU
			Receptacle	Front mount, nut fixing (HH)	JMXHH1G03MCUDSU	JMXHH1G03FCUDSU
		Rear Mount, nut fixing (HC)		JMXHC1G03MCUDSU	JMXHC1G03FCUDSU	
		Plug	Straight plug (FH)		JMXFH1G03MCUDSU	JMXFH1G03FCUDSU
Straight PC Tail see page 59	Receptacle		Rear Mount, nut fixing (HC) 	Please consult us	JMXHC1G03FPUDSU	
90° PC Tail see page 60	Receptacle	Rear Mount, nut fixing (HC) 	Please consult us	JMXHC1G03FQUDSU		
IP50	Solder contacts see page 25	Receptacle	Front mount, nut fixing (ER)	JMXER1G03MSUDSU	JMXER1G03FSUDSU	
			Rear Mount, nut fixing (EP)	JMXEP1G03MSUDSU	JMXEP1G03FSUDSU	
	Solder contacts see page 25	Plug	Straight plug (FD)		JMXFD1G03MSUDSU	JMXFD1G03FSUDSU
			Receptacle	Front mount, nut fixing (ER)	JMXER1G03MCUDSU	JMXER1G03FCUDSU
		Rear Mount, nut fixing (EP)		JMXEP1G03MCUDSU	JMXEP1G03FCUDSU	
		Plug	Straight plug (FD)		JMXFD1G03MCUDSU	JMXFD1G03FCUDSU
	Straight PC Tail see page 59		Receptacle	Rear Mount, nut fixing (EP)	Please consult us	JMXEP1G03FPUDSU
	90° PC Tail see page 60	Receptacle	Rear Mount, nut fixing (EP)	Please consult us	JMXEP1G03FQUDSU	

 : Sealed in Unmated Condition

 : Preferred part numbers with shorter leadtimes

JMX1-03 (3 x Ø 1.3 mm / 3 x Ø 0.051")

Dimensions (For mated connector lengths see page 25)

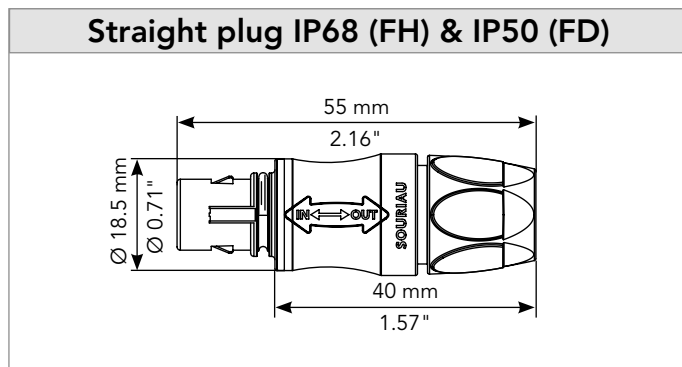
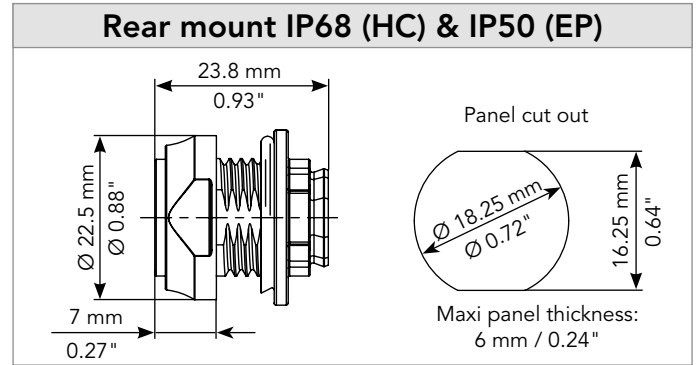
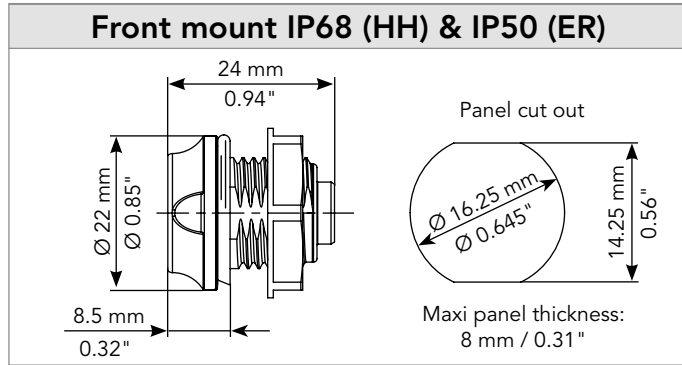

Connector color coding

Coding	Color	Part number ⁽¹⁾					
		Receptacle IP68		Receptacle IP50		Plug IP68	Plug IP50
		Front mount	Rear mount	Front mount	Rear mount	Straight	Straight
G	None	JMXHH1G03**UDSU	JMXHC1G**UDSU	JMXER1G03**UDSU	JMXEP1G03**UDSU	JMXFD1G03**UDSU	JMXFH1G03**UDSU
A	Blue	JMXHH1A03**UDSA	JMXHC1A03**UDSA	JMXER1A03**UDSA	JMXEP1A03**UDSA	JMXFD1A03**UDSA	JMXFH1A03**UDSA
B	Red	JMXHH1B03**UDSR	JMXHC1B03**UDSR	JMXER1B03**UDSR	JMXEP1B03**UDSR	JMXFD1B03**UDSR	JMXFH1B03**UDSR
C	Green	JMXHH1C03**UDSV	JMXHC1C03**UDSV	JMXER1C03**UDSV	JMXEP1C03**UDSV	JMXFD1C03**UDSV	JMXFH1C03**UDSV
D	Orange	JMXHH1D03**UDSO	JMXHC1D03**UDSO	JMXER1D03**UDSO	JMXEP1D03**UDSO	JMXFD1D03**UDSO	JMXFH1D03**UDSO
E	Yellow	JMXHH1E03**UDSJ	JMXHC1E03**UDSJ	JMXER1E03**UDSJ	JMXEP1E03**UDSJ	JMXFD1E03**UDSJ	JMXFH1E03**UDSJ

"**": Gender / Termination

JMX1-03 (3 x Ø 1.3 mm / 3 x Ø 0.051")

Accessories

Receptacle dust cap



Part number
JMXBR1

Plug dust cap

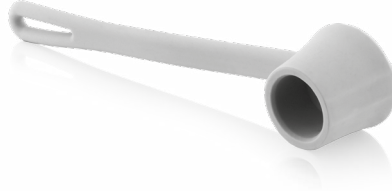

Part number
JMXBF1

Tooling for crimp contacts

Crimp tooling



Part number
M22520/7-01

Locator



Part number	
Male	Female
JBX10UTLP13	JBX10UTLS13

Extraction tool



Part number
JBXOUTDC13

JMX1-03 (3 x Ø 1.3 mm / 3 x Ø 0.051")

Contacts

Ø 1.3 mm / Ø 0.051"	Contact type	Plating	Contact locking type	AWG
Solder	Machined	0.5 µm gold over 3 to 5 µm Ni	Removable on plugs	20 and smaller
Crimp	Machined	0.5 µm gold over 3 to 5 µm Ni	Removable	18 - 20 - 22

For more information see pages 57 to 58

Mated connector length

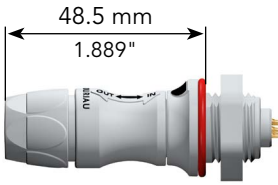
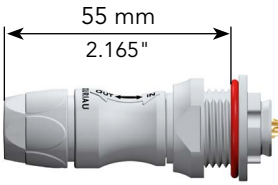
Plug + Receptacle	
 <p>48.5 mm 1.889"</p> <p>Plug with front mount</p>	 <p>55 mm 2.165"</p> <p>Plug with rear mount</p>

IEC / UL characteristics	
<p>IEC 9A 840 Vdc 1.5 kV 2</p>	<p>UL 9A 230V UL94 HB</p>

JMX1-04 (4 x Ø 0.9 mm / 4 x Ø 0.035")

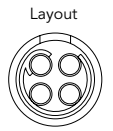

Connector part number (Products without color coding)

Sealing	Contact type	Connector type	Description	Part number	
				Male insert	Female insert
IP68	Crimp contacts see page 29	Receptacle	Front mount, nut fixing (HH) ☁	JMXHH1G04MSUDSU	JMXHH1G04FSUDSU
			Rear Mount, nut fixing (HC) ☁	JMXHC1G04MSUDSU	JMXHC1G04FSUDSU
		Plug	Straight plug (FH)	JMXFH1G04MSUDSU	JMXFH1G04FSUDSU
	Crimp contacts see page 29	Receptacle	Front mount, nut fixing (HH)	JMXHH1G04MCUDSU	JMXHH1G04FCUDSU
			Rear Mount, nut fixing (HC)	JMXHC1G04MCUDSU	JMXHC1G04FCUDSU
		Plug	Straight plug (FH)	JMXFH1G04MCUDSU	JMXFH1G04FCUDSU
	Straight PC Tail see page 59	Receptacle	Rear Mount, nut fixing (HC) ☁	Please consult us	JMXHC1G04FPUDSU
90° PC Tail see page 60	Receptacle	Rear Mount, nut fixing (HC) ☁	Please consult us	JMXHC1G04FQUDSU	
IP50	Crimp contacts see page 29	Receptacle	Front mount, nut fixing (ER)	JMXER1G04MSUDSU	JMXER1G04FSUDSU
			Rear Mount, nut fixing (EP)	JMXEP1G04MSUDSU	JMXEP1G04FSUDSU
		Plug	Straight plug (FD)	JMXFD1G04MSUDSU	JMXFD1G04FSUDSU
	Crimp contacts see page 29	Receptacle	Front mount, nut fixing (ER)	JMXER1G04MCUDSU	JMXER1G04FCUDSU
			Rear Mount, nut fixing (EP)	JMXEP1G04MCUDSU	JMXEP1G04FCUDSU
		Plug	Straight plug (FD)	JMXFD1G04MCUDSU	JMXFD1G04FCUDSU
	Straight PC Tail see page 59	Receptacle	Rear Mount, nut fixing (EP)	Please consult us	JMXEP1G04FPUDSU
90° PC Tail see page 60	Receptacle	Rear Mount, nut fixing (EP)	Please consult us	JMXEP1G04FQUDSU	

☁ : Sealed in Unmated Condition

■ : Preferred part numbers with shorter leadtimes

JMX1-04 (4 x Ø 0.9 mm / 4 x Ø 0.035")

Dimensions (For mated connector lengths see page 29)

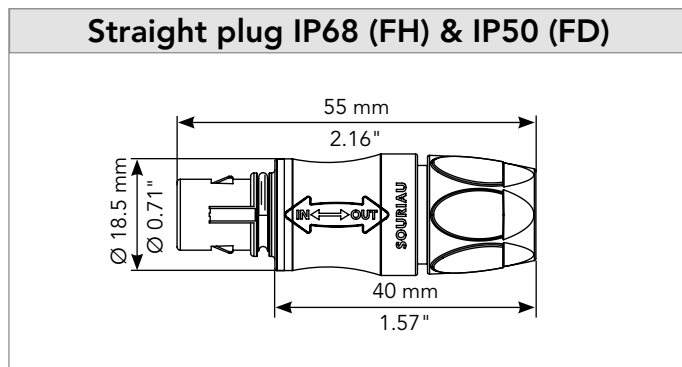
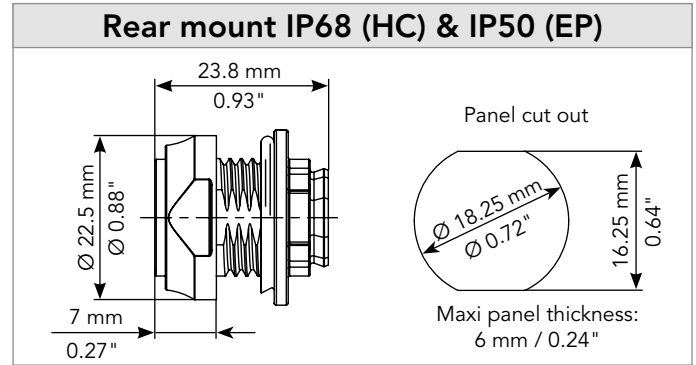
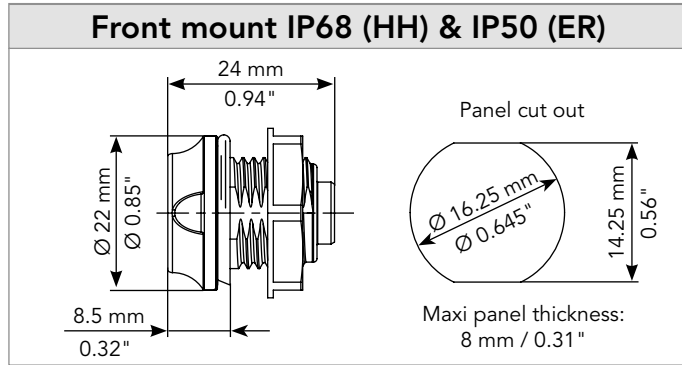

Connector color coding

Coding	Color	Part number ⁽¹⁾					
		Receptacle IP68		Receptacle IP50		Plug IP68	Plug IP50
		Front mount	Rear mount	Front mount	Rear mount	Straight	Straight
G	None	JMXHH1G04**UDSU	JMXHC1G**UDSU	JMXER1G04**UDSU	JMXEP1G04**UDSU	JMXFD1G04**UDSU	JMXFH1G04**UDSU
A	Blue	JMXHH1A04**UDSA	JMXHC1A04**UDSA	JMXER1A04**UDSA	JMXEP1A04**UDSA	JMXFD1A04**UDSA	JMXFH1A04**UDSA
B	Red	JMXHH1B04**UDSR	JMXHC1B04**UDSR	JMXER1B04**UDSR	JMXEP1B04**UDSR	JMXFD1B04**UDSR	JMXFH1B04**UDSR
C	Green	JMXHH1C04**UDSV	JMXHC1C04**UDSV	JMXER1C04**UDSV	JMXEP1C04**UDSV	JMXFD1C04**UDSV	JMXFH1C04**UDSV
D	Orange	JMXHH1D04**UDSO	JMXHC1D04**UDSO	JMXER1D04**UDSO	JMXEP1D04**UDSO	JMXFD1D04**UDSO	JMXFH1D04**UDSO
E	Yellow	JMXHH1E04**UDSJ	JMXHC1E04**UDSJ	JMXER1E04**UDSJ	JMXEP1E04**UDSJ	JMXFD1E04**UDSJ	JMXFH1E04**UDSJ

"**": Gender / Termination

JMX1-04 (4 x Ø 0.9 mm / 4 x Ø 0.035")

Accessories

Receptacle dust cap



Part number
JMXBR1

Plug dust cap

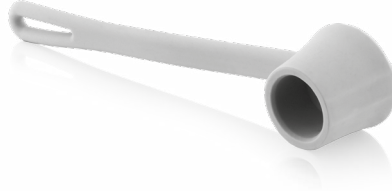

Part number
JMXBF1

Tooling for crimp contacts

Crimp tooling



Part number
M22520/7-01

Locator



Part number	
Male	Female
JBX10UTLP09	JBX10UTLS09

Extraction tool



Part number
JBXOUTDC09

JMX1-04 (4 x Ø 0.9 mm / 4 x Ø 0.035")

Contacts

Ø 0.9 mm / Ø 0.035"	Contact type	Plating	Contact locking type	AWG
Solder	Machined	0.5 µm gold over 3 to 5 µm Ni	Removable on plugs	22 and smaller
Crimp	Machined	0.5 µm gold over 3 to 5 µm Ni	Removable	20 - 22 - 24

For more information see pages 57 to 58

Mated connector length

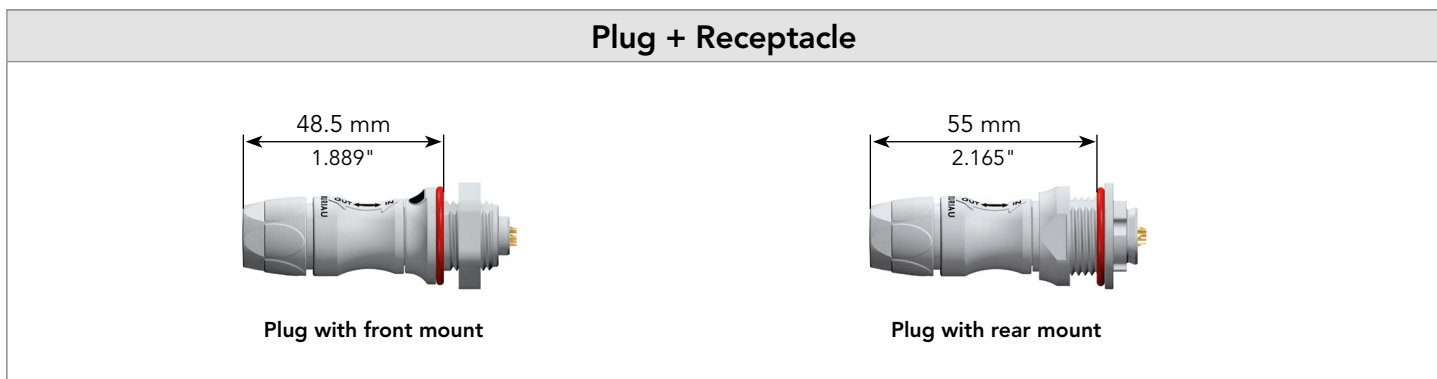

IEC / UL characteristics	
<p>IEC 8A 840 Vdc 1.5 kV 2</p>	<p>UL 8A 230V UL94 HB</p>

JMX1-05 (5 x Ø 0.9 mm / 5 x Ø 0.035")

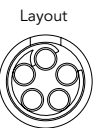

Connector part number (Products without color coding)

Sealing	Contact type	Connector type	Description	Part number		
				Male insert	Female insert	
IP68	Solder contacts see page 33	Receptacle	Front mount, nut fixing (HH) ☁	JMXHH1G05MSUDSU	JMXHH1G05FSUDSU	
			Rear Mount, nut fixing (HC) ☁	JMXHC1G05MSUDSU	JMXHC1G05FSUDSU	
	Solder contacts see page 33	Plug	Straight plug (FH)		JMXFH1G05MSUDSU	JMXFH1G05FSUDSU
			Receptacle	Front mount, nut fixing (HH)	JMXHH1G05MCUDSU	JMXHH1G05FCUDSU
		Rear Mount, nut fixing (HC)		JMXHC1G05MCUDSU	JMXHC1G05FCUDSU	
		Plug	Straight plug (FH)		JMXFH1G05MCUDSU	JMXFH1G05FCUDSU
Straight PC Tail see page 59	Receptacle		Rear Mount, nut fixing (HC) ☁	Please consult us	JMXHC1G05FPUDSU	
90° PC Tail see page 60	Receptacle	Rear Mount, nut fixing (HC) ☁	Please consult us	JMXHC1G05FQUDSU		
IP50	Solder contacts see page 33	Receptacle	Front mount, nut fixing (ER)	JMXER1G05MSUDSU	JMXER1G05FSUDSU	
			Rear Mount, nut fixing (EP)	JMXEP1G05MSUDSU	JMXEP1G05FSUDSU	
	Solder contacts see page 33	Plug	Straight plug (FD)		JMXFD1G05MSUDSU	JMXFD1G05FSUDSU
			Receptacle	Front mount, nut fixing (ER)	JMXER1G05MCUDSU	JMXER1G05FCUDSU
		Rear Mount, nut fixing (EP)		JMXEP1G05MCUDSU	JMXEP1G05FCUDSU	
		Plug	Straight plug (FD)		JMXFD1G05MCUDSU	JMXFD1G05FCUDSU
	Straight PC Tail see page 59		Receptacle	Rear Mount, nut fixing (EP)	Please consult us	JMXEP1G05FPUDSU
	90° PC Tail see page 60	Receptacle	Rear Mount, nut fixing (EP)	Please consult us	JMXEP1G05FQUDSU	

☁ : Sealed in Unmated Condition

■ : Preferred part numbers with shorter leadtimes

JMX1-05 (5 x Ø 0.9 mm / 5 x Ø 0.035")

Dimensions (For mated connector lengths see page 33)

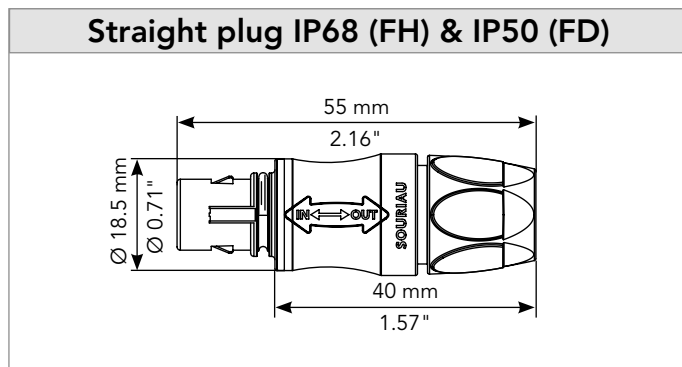
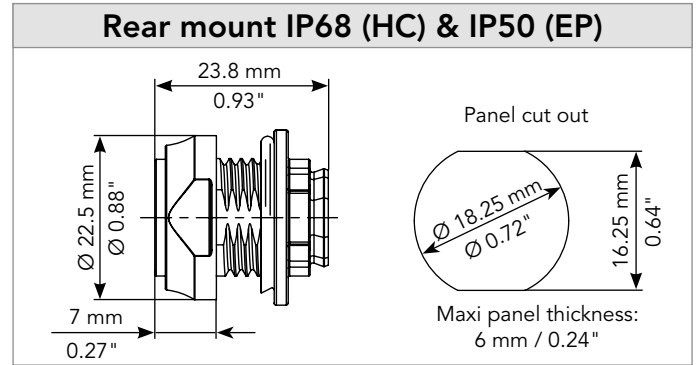
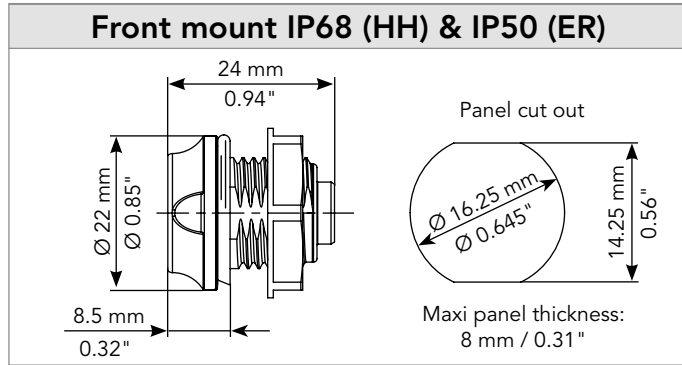

Connector color coding

Coding	Color	Part number ⁽¹⁾					
		Receptacle IP68		Receptacle IP50		Plug IP68	Plug IP50
		Front mount	Rear mount	Front mount	Rear mount	Straight	Straight
G	None	JMXHH1G05**UDSU	JMXHC1G**UDSU	JMXER1G05**UDSU	JMXEP1G05**UDSU	JMXFD1G05**UDSU	JMXFH1G05**UDSU
A	Blue	JMXHH1A05**UDSA	JMXHC1A05**UDSA	JMXER1A05**UDSA	JMXEP1A05**UDSA	JMXFD1A05**UDSA	JMXFH1A05**UDSA
B	Red	JMXHH1B05**UDSR	JMXHC1B05**UDSR	JMXER1B05**UDSR	JMXEP1B05**UDSR	JMXFD1B05**UDSR	JMXFH1B05**UDSR
C	Green	JMXHH1C05**UDSV	JMXHC1C05**UDSV	JMXER1C05**UDSV	JMXEP1C05**UDSV	JMXFD1C05**UDSV	JMXFH1C05**UDSV
D	Orange	JMXHH1D05**UDSO	JMXHC1D05**UDSO	JMXER1D05**UDSO	JMXEP1D05**UDSO	JMXFD1D05**UDSO	JMXFH1D05**UDSO
E	Yellow	JMXHH1E05**UDSJ	JMXHC1E05**UDSJ	JMXER1E05**UDSJ	JMXEP1E05**UDSJ	JMXFD1E05**UDSJ	JMXFH1E05**UDSJ

"**": Gender / Termination

JMX1-05 (5 x Ø 0.9 mm / 5 x Ø 0.035")

Accessories

Receptacle dust cap



Part number
JMXBR1

Plug dust cap



Part number
JMXBF1

Tooling for crimp contacts

Crimp tooling



Part number
M22520/7-01

Locator



Part number	
Male	Female
JBX10UTLP09	JBX10UTLS09

Extraction tool



Part number
JBXOUTDC09

JMX1-05 (5 x Ø 0.9 mm / 5 x Ø 0.035")

Contacts

Ø 0.7 mm / Ø 0.027"	Contact type	Plating	Contact locking type	AWG
Solder	Machined	0.5 µm gold over 3 to 5 µm Ni	Removable on plugs	22 and smaller
Crimp	Machined	0.5 µm gold over 3 to 5 µm Ni	Removable	20 - 22 - 24

For more information see pages 57 to 58

Mated connector length

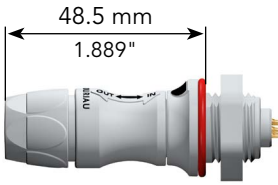
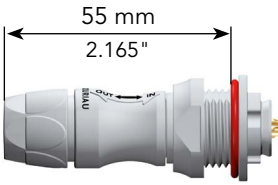
Plug + Receptacle	
 <p>48.5 mm 1.889"</p> <p>Plug with front mount</p>	 <p>55 mm 2.165"</p> <p>Plug with rear mount</p>

IEC / UL characteristics	
<p>IEC 7A 840 Vdc 1.5 kV 2</p>	<p>UL 7A 230V UL94 HB</p>

JMX1-06 (6 x Ø 0.7 mm / 6 x Ø 0.027")

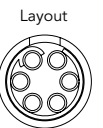

Connector part number (Products without color coding)

Sealing	Contact type	Connector type	Description	Part number	
				Male insert	Female insert
IP68	Solder contacts see page 37	Receptacle	Front mount, nut fixing (HH) ☁	JMXHH1G06MSUDSU	JMXHH1G06FSUDSU
			Rear Mount, nut fixing (HC) ☁	JMXHC1G06MSUDSU	JMXHC1G06FSUDSU
		Plug	Straight plug (FH)	JMXFH1G06MSUDSU	JMXFH1G06FSUDSU
	Solder contacts see page 37	Receptacle	Front mount, nut fixing (HH)	JMXHH1G06MCUDSU	JMXHH1G06FCUDSU
			Rear Mount, nut fixing (HC)	JMXHC1G06MCUDSU	JMXHC1G06FCUDSU
		Plug	Straight plug (FH)	JMXFH1G06MCUDSU	JMXFH1G06FCUDSU
	Straight PC Tail see page 59	Receptacle	Rear Mount, nut fixing (HC) ☁	Please consult us	JMXHC1G06FPUDSU
	90° PC Tail see page 60	Receptacle	Rear Mount, nut fixing (HC) ☁	Please consult us	JMXHC1G06FQUDSU
IP50	Solder contacts see page 37	Receptacle	Front mount, nut fixing (ER)	JMXER1G06MSUDSU	JMXER1G06FSUDSU
			Rear Mount, nut fixing (EP)	JMXEP1G06MSUDSU	JMXEP1G06FSUDSU
		Plug	Straight plug (FD)	JMXFD1G06MSUDSU	JMXFD1G06FSUDSU
	Solder contacts see page 37	Receptacle	Front mount, nut fixing (ER)	JMXER1G06MCUDSU	JMXER1G06FCUDSU
			Rear Mount, nut fixing (EP)	JMXEP1G06MCUDSU	JMXEP1G06FCUDSU
		Plug	Straight plug (FD)	JMXFD1G06MCUDSU	JMXFD1G06FCUDSU
	Straight PC Tail see page 59	Receptacle	Rear Mount, nut fixing (EP)	Please consult us	JMXEP1G06FPUDSU
	90° PC Tail see page 60	Receptacle	Rear Mount, nut fixing (EP)	Please consult us	JMXEP1G06FQUDSU

☁ : Sealed in Unmated Condition

■ : Preferred part numbers with shorter leadtimes

JMX1-06 (6 x Ø 0.7 mm / 6 x Ø 0.027")

Dimensions (For mated connector lengths see page 37)

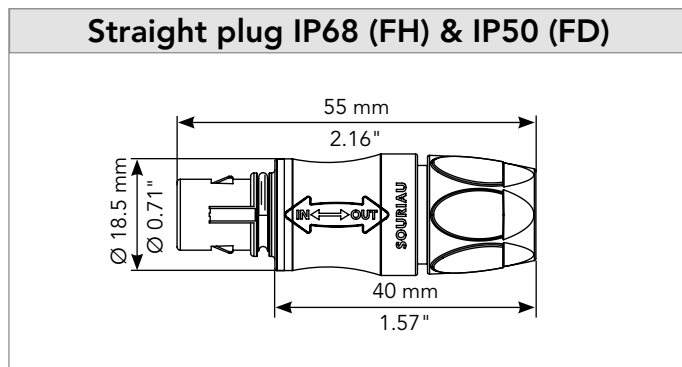
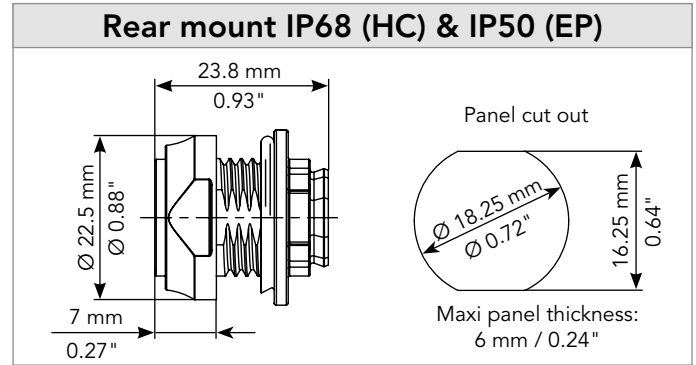
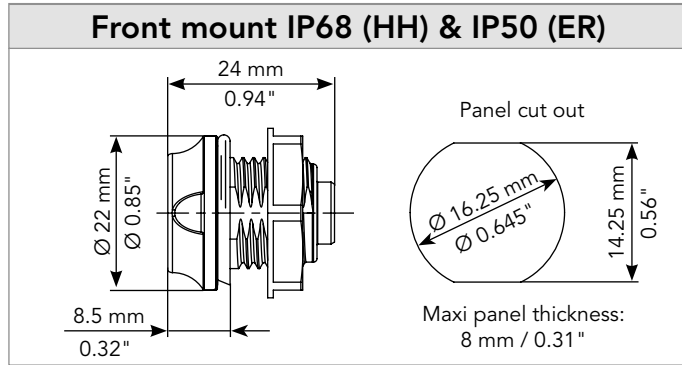

Connector color coding

Coding	Color	Part number ⁽¹⁾					
		Receptacle IP68		Receptacle IP50		Plug IP68	Plug IP50
		Front mount	Rear mount	Front mount	Rear mount	Straight	Straight
G	None	JMXHH1G06**UDSU	JMXHC1G**UDSU	JMXER1G06**UDSU	JMXEP1G06**UDSU	JMXFD1G06**UDSU	JMXFH1G06**UDSU
A	Blue	JMXHH1A06**UDSA	JMXHC1A06**UDSA	JMXER1A06**UDSA	JMXEP1A06**UDSA	JMXFD1A06**UDSA	JMXFH1A06**UDSA
B	Red	JMXHH1B06**UDSR	JMXHC1B06**UDSR	JMXER1B06**UDSR	JMXEP1B06**UDSR	JMXFD1B06**UDSR	JMXFH1B06**UDSR
C	Green	JMXHH1C06**UDSV	JMXHC1C06**UDSV	JMXER1C06**UDSV	JMXEP1C06**UDSV	JMXFD1C06**UDSV	JMXFH1C06**UDSV
D	Orange	JMXHH1D06**UDSO	JMXHC1D06**UDSO	JMXER1D06**UDSO	JMXEP1D06**UDSO	JMXFD1D06**UDSO	JMXFH1D06**UDSO
E	Yellow	JMXHH1E06**UDSJ	JMXHC1E06**UDSJ	JMXER1E06**UDSJ	JMXEP1E06**UDSJ	JMXFD1E06**UDSJ	JMXFH1E06**UDSJ

"**": Gender / Termination

JMX1-06 (6 x Ø 0.7 mm / 6 x Ø 0.027")

Accessories

Receptacle dust cap



Part number
JMXBR1

Plug dust cap

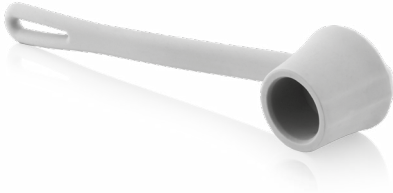

Part number
JMXBF1

Tooling for crimp contacts

Crimp tooling



Part number
M22520/7-01

Locator



Part number	
Male	Female
JBX10UTLP07	JBX10UTLS07

Extraction tool



Part number
JBXOUTDC07

JMX1-06 (6 x Ø 0.7 mm / 6 x Ø 0.027")

Contacts

Ø 0.7 mm / Ø 0.027"	Contact type	Plating	Contact locking type	AWG
Solder	Machined	0.5 µm gold over 3 to 5 µm Ni	Fixed	22 and smaller
Crimp	Machined	0.5 µm gold over 3 to 5 µm Ni	Removable	22 - 24 - 26

For more information see pages 57 to 58

Mated connector length

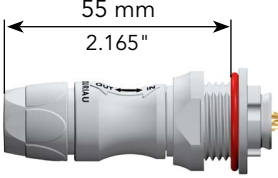
Plug + Receptacle	
 <p>48.5 mm 1.889"</p> <p>Plug with front mount</p>	 <p>55 mm 2.165"</p> <p>Plug with rear mount</p>



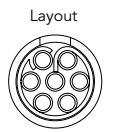

Connector

IEC / UL characteristics	
<p>IEC 6A 840 Vdc 1.5 kV 2</p>	<p>UL 6A 160V UL94 HB</p>

JMX1-07 (7 x Ø 0.7 mm / 7 x Ø 0.027")



Connector part number (Products without color coding)

Sealing	Contact type	Connector type	Description	Part number	
				Male insert	Female insert
IP68	Solder contacts see page 41	Receptacle	Front mount, nut fixing (HH) 	JMXHH1G07MSUDSU	JMXHH1G07FSUDSU
			Rear Mount, nut fixing (HC) 	JMXHC1G07MSUDSU	JMXHC1G07FSUDSU
		Plug	Straight plug (FH)	JMXFH1G07MSUDSU	JMXFH1G07FSUDSU
	Solder contacts see page 41	Receptacle	Front mount, nut fixing (HH)	JMXHH1G07MCUDSU	JMXHH1G07FCUDSU
			Rear Mount, nut fixing (HC)	JMXHC1G07MCUDSU	JMXHC1G07FCUDSU
		Plug	Straight plug (FH)	JMXFH1G07MCUDSU	JMXFH1G07FCUDSU
	Straight PC Tail see page 59	Receptacle	Rear Mount, nut fixing (HC) 	Please consult us	JMXHC1G07FPUDSU
90° PC Tail see page 60	Receptacle	Rear Mount, nut fixing (HC) 	Please consult us	JMXHC1G07FQUDSU	
IP50	Solder contacts see page 41	Receptacle	Front mount, nut fixing (ER)	JMXER1G07MSUDSU	JMXER1G07FSUDSU
			Rear Mount, nut fixing (EP)	JMXEP1G07MSUDSU	JMXEP1G07FSUDSU
		Plug	Straight plug (FD)	JMXFD1G07MSUDSU	JMXFD1G07FSUDSU
	Solder contacts see page 41	Receptacle	Front mount, nut fixing (ER)	JMXER1G07MCUDSU	JMXER1G07FCUDSU
			Rear Mount, nut fixing (EP)	JMXEP1G07MCUDSU	JMXEP1G07FCUDSU
		Plug	Straight plug (FD)	JMXFD1G07MCUDSU	JMXFD1G07FCUDSU
	Straight PC Tail see page 59	Receptacle	Rear Mount, nut fixing (EP)	Please consult us	JMXEP1G07FPUDSU
90° PC Tail see page 60	Receptacle	Rear Mount, nut fixing (EP)	Please consult us	JMXEP1G07FQUDSU	

 : Sealed in Unmated Condition

 : Preferred part numbers with shorter leadtimes

JMX Series | Connector

JMX1-07 (7 x Ø 0.7 mm / 7 x Ø 0.027")

Dimensions (For mated connector lengths see page 41)

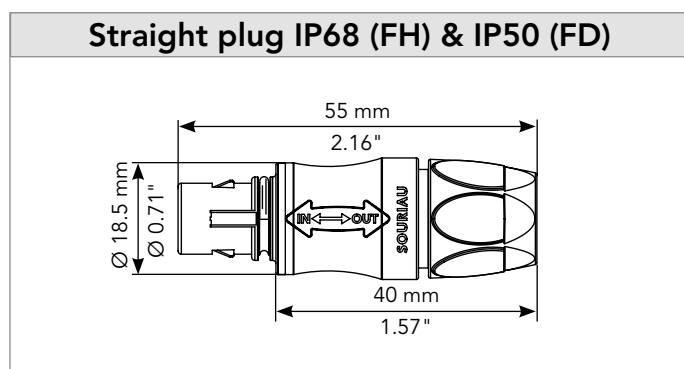
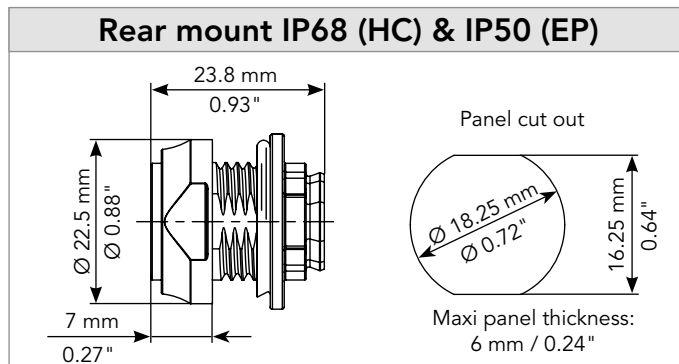
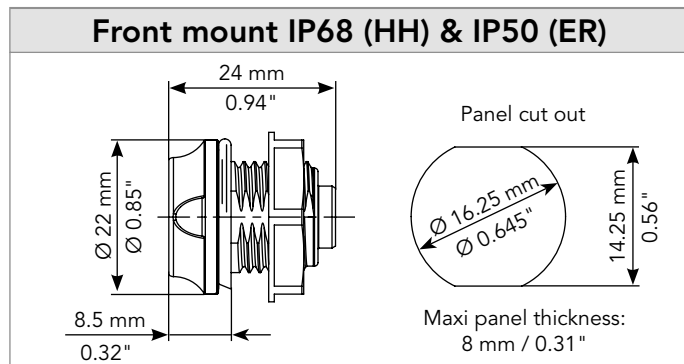

Connector color coding

Coding	Color	Part number ⁽¹⁾					
		Receptacle IP68		Receptacle IP50		Plug IP68	Plug IP50
		Front mount	Rear mount	Front mount	Rear mount	Straight	Straight
G	None	JMXHH1G07**UDSU	JMXHC1G**UDSU	JMXER1G07**UDSU	JMXEP1G07**UDSU	JMXFD1G07**UDSU	JMXFH1G07**UDSU
A	Blue	JMXHH1A07**UDSA	JMXHC1A07**UDSA	JMXER1A07**UDSA	JMXEP1A07**UDSA	JMXFD1A07**UDSA	JMXFH1A07**UDSA
B	Red	JMXHH1B07**UDSR	JMXHC1B07**UDSR	JMXER1B07**UDSR	JMXEP1B07**UDSR	JMXFD1B07**UDSR	JMXFH1B07**UDSR
C	Green	JMXHH1C07**UDSV	JMXHC1C07**UDSV	JMXER1C07**UDSV	JMXEP1C07**UDSV	JMXFD1C07**UDSV	JMXFH1C07**UDSV
D	Orange	JMXHH1D07**UDSO	JMXHC1D07**UDSO	JMXER1D07**UDSO	JMXEP1D07**UDSO	JMXFD1D07**UDSO	JMXFH1D07**UDSO
E	Yellow	JMXHH1E07**UDSJ	JMXHC1E07**UDSJ	JMXER1E07**UDSJ	JMXEP1E07**UDSJ	JMXFD1E07**UDSJ	JMXFH1E07**UDSJ

"**": Gender / Termination

JMX1-07 (7 x Ø 0.7 mm / 7 x Ø 0.027")

Accessories

Receptacle dust cap



Part number
JMXBR1

Plug dust cap

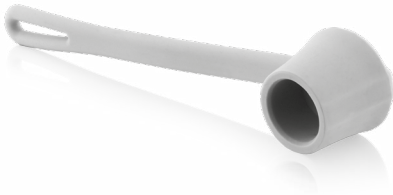

Part number
JMXBF1

Tooling for crimp contacts

Crimp tooling



Part number
M22520/7-01

Locator



Part number	
Male	Female
JBX10UTLP07	JBX10UTLS07

Extraction tool



Part number
JBXOUTDC07

JMX1-07 (7 x Ø 0.7 mm / 7 x Ø 0.027")

Contacts

Ø 0.7 mm / Ø 0.027"	Contact type	Plating	Contact locking type	AWG
Solder	Machined	0.5 µm gold over 3 to 5 µm Ni	Fixed	22 and smaller
Crimp	Machined	0.5 µm gold over 3 to 5 µm Ni	Removable	22 - 24 - 26

For more information see pages 57 to 58

Mated connector length

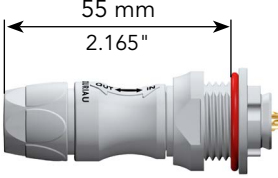
Plug + Receptacle	
 <p>48.5 mm 1.889"</p> <p>Plug with front mount</p>	 <p>55 mm 2.165"</p> <p>Plug with rear mount</p>

Connector

IEC / UL characteristics	
<p>IEC 5A 840 Vdc 1.5 kV 2</p>	<p>UL 5A 160V UL94 HB</p>

JMX1-08 (8 x Ø 0.7 mm / 8 x Ø 0.027")

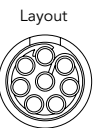

Connector part number (Products without color coding)

Sealing	Contact type	Connector type	Description	Part number		
				Male insert	Female insert	
IP68	Solder contacts see page 45	Receptacle	Front mount, nut fixing (HH)	JMXHH1G08MSUDSU	JMXHH1G08FSUDSU	
			Rear Mount, nut fixing (HC)	JMXHC1G08MSUDSU	JMXHC1G08FSUDSU	
	Solder contacts see page 45	Plug	Straight plug (FH)		JMXFH1G08MSUDSU	JMXFH1G08FSUDSU
			Receptacle	Front mount, nut fixing (HH)	JMXHH1G08MCUDSU	JMXHH1G08FCUDSU
		Rear Mount, nut fixing (HC)		JMXHC1G08MCUDSU	JMXHC1G08FCUDSU	
		Plug	Straight plug (FH)		JMXFH1G08MCUDSU	JMXFH1G08FCUDSU
Straight PC Tail see page 59	Receptacle		Rear Mount, nut fixing (HC)	Please consult us	JMXHC1G08FPUDSU	
90° PC Tail see page 60	Receptacle	Rear Mount, nut fixing (HC)	Please consult us	JMXHC1G08FQUDSU		
IP50	Solder contacts see page 45	Receptacle	Front mount, nut fixing (ER)	JMXER1G08MSUDSU	JMXER1G08FSUDSU	
			Rear Mount, nut fixing (EP)	JMXEP1G08MSUDSU	JMXEP1G08FSUDSU	
	Solder contacts see page 45	Plug	Straight plug (FD)		JMXFD1G08MSUDSU	JMXFD1G08FSUDSU
			Receptacle	Front mount, nut fixing (ER)	JMXER1G08MCUDSU	JMXER1G08FCUDSU
		Rear Mount, nut fixing (EP)		JMXEP1G08MCUDSU	JMXEP1G08FCUDSU	
		Plug	Straight plug (FD)		JMXFD1G08MCUDSU	JMXFD1G08FCUDSU
Straight PC Tail see page 59	Receptacle		Rear Mount, nut fixing (EP)	Please consult us	JMXEP1G08FPUDSU	
90° PC Tail see page 60	Receptacle	Rear Mount, nut fixing (EP)	Please consult us	JMXEP1G08FQUDSU		

: Sealed in Unmated Condition

: Preferred part numbers with shorter leadtimes

JMX Series | Connector

JMX1-08 (8 x Ø 0.7 mm / 8 x Ø 0.027")

Dimensions (For mated connector lengths see page 45)

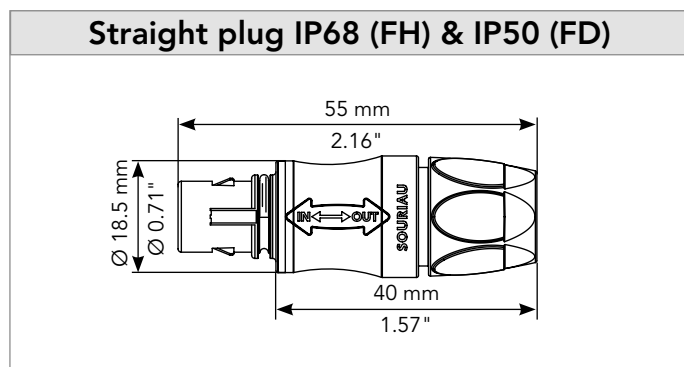
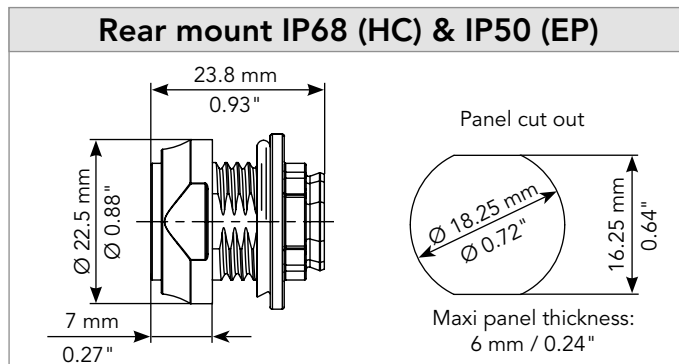
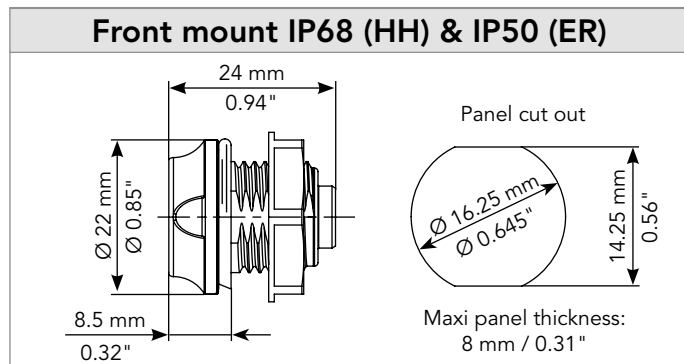

Connector color coding

Coding	Color	Part number ⁽¹⁾					
		Receptacle IP68		Receptacle IP50		Plug IP68	Plug IP50
		Front mount	Rear mount	Front mount	Rear mount	Straight	Straight
G	None	JMXHH1G08**UDSU	JMXHC1G**UDSU	JMXER1G08**UDSU	JMXEP1G08**UDSU	JMXFD1G08**UDSU	JMXFH1G08**UDSU
A	Blue	JMXHH1A08**UDSA	JMXHC1A08**UDSA	JMXER1A08**UDSA	JMXEP1A08**UDSA	JMXFD1A08**UDSA	JMXFH1A08**UDSA
B	Red	JMXHH1B08**UDSR	JMXHC1B08**UDSR	JMXER1B08**UDSR	JMXEP1B08**UDSR	JMXFD1B08**UDSR	JMXFH1B08**UDSR
C	Green	JMXHH1C08**UDSV	JMXHC1C08**UDSV	JMXER1C08**UDSV	JMXEP1C08**UDSV	JMXFD1C08**UDSV	JMXFH1C08**UDSV
D	Orange	JMXHH1D08**UDSO	JMXHC1D08**UDSO	JMXER1D08**UDSO	JMXEP1D08**UDSO	JMXFD1D08**UDSO	JMXFH1D08**UDSO
E	Yellow	JMXHH1E08**UDSJ	JMXHC1E08**UDSJ	JMXER1E08**UDSJ	JMXEP1E08**UDSJ	JMXFD1E08**UDSJ	JMXFH1E08**UDSJ

"**": Gender / Termination

JMX1-08 (8 x Ø 0.7 mm / 8 x Ø 0.027")

Accessories

Receptacle dust cap



Part number
JMXBR1

Plug dust cap

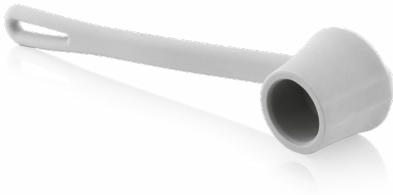

Part number
JMXBF1

Tooling for crimp contacts

Crimp tooling



Part number
M22520/7-01

Locator



Part number	
Male	Female
JBX10UTLP07	JBX10UTLS07

Extraction tool



Part number
JBXOUTDC07

JMX1-08 (8 x Ø 0.7 mm / 8 x Ø 0.027")

Contacts

Ø 0.7 mm / Ø 0.027"	Contact type	Plating	Contact locking type	AWG
Solder	Machined	0.5 µm gold over 3 to 5 µm Ni	Fixed	22 and smaller
Crimp	Machined	0.5 µm gold over 3 to 5 µm Ni	Removable	22 - 24 - 26

For more information see pages 57 to 58

Mated connector length

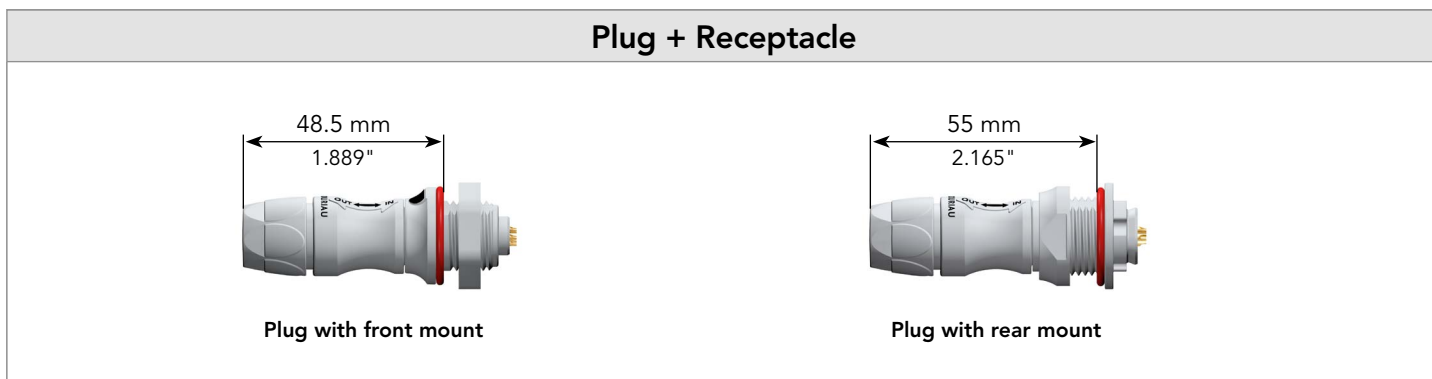

IEC / UL characteristics	
<p>IEC 5A 840 Vdc 1.5 kV 2</p>	<p>UL 5A 100V UL94 HB</p>

JMX1-10 (10 x Ø 0.5 mm / 10 x Ø 0.019")

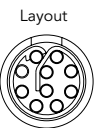

Connector part number (Products without color coding)

Sealing	Contact type	Connector type	Description	Part number		
				Male insert	Female insert	
IP68	Solder contacts see page 49	Receptacle	Front mount, nut fixing (HH) ☁	JMXHH1G10MSUDSU	JMXHH1G10FSUDSU	
			Rear Mount, nut fixing (HC) ☁	JMXHC1G10MSUDSU	JMXHC1G10FSUDSU	
	Plug	Straight plug (FH)	JMXFH1G10MSUDSU	JMXFH1G10FSUDSU		
			Receptacle	Rear Mount, nut fixing (HC) ☁	Please consult us	JMXHC1G10FPUDSU
				Receptacle	Rear Mount, nut fixing (HC) ☁	Please consult us
IP50	Solder contacts see page 49	Receptacle	Front mount, nut fixing (ER)	JMXER1G10MSUDSU	JMXER1G10FSUDSU	
			Rear Mount, nut fixing (EP)	JMXEP1G10MSUDSU	JMXEP1G10FSUDSU	
		Plug	Straight plug (FD)	JMXFD1G10MSUDSU	JMXFD1G10FSUDSU	
	Straight PC Tail see page 59	Receptacle	Rear Mount, nut fixing (EP)	Please consult us	JMXEP1G10FPUDSU	
		Receptacle	Rear Mount, nut fixing (EP)	Please consult us	Please consult us	

☁ : Sealed in Unmated Condition

■ : Preferred part numbers with shorter leadtimes

JMX1-10 (10 x Ø 0.5 mm / 10 x Ø 0.019")

Dimensions (For mated connector lengths see page 49)

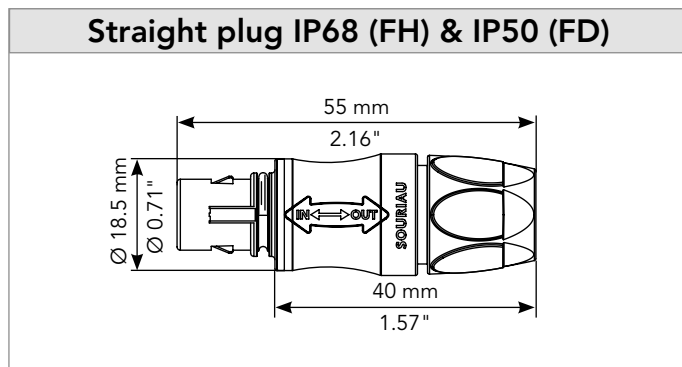
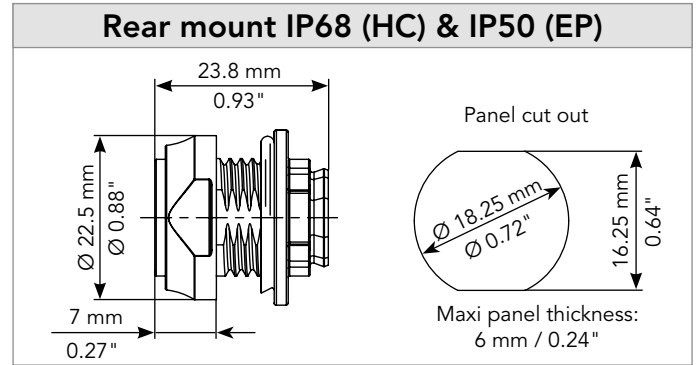
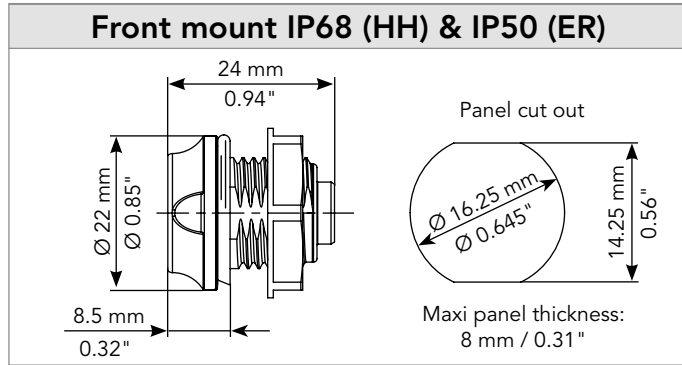

Connector color coding

Coding	Color	Part number ⁽¹⁾					
		Receptacle IP68		Receptacle IP50		Plug IP68	Plug IP50
		Front mount	Rear mount	Front mount	Rear mount	Straight	Straight
G	None	JMXHH1G10**UDSU	JMXHC1G**UDSU	JMXER1G10**UDSU	JMXEP1G10**UDSU	JMXFD1G10**UDSU	JMXFH1G10**UDSU
A	Blue	JMXHH1A10**UDSA	JMXHC1A10**UDSA	JMXER1A10**UDSA	JMXEP1A10**UDSA	JMXFD1A10**UDSA	JMXFH1A10**UDSA
B	Red	JMXHH1B10**UDSR	JMXHC1B10**UDSR	JMXER1B10**UDSR	JMXEP1B10**UDSR	JMXFD1B10**UDSR	JMXFH1B10**UDSR
C	Green	JMXHH1C10**UDSV	JMXHC1C10**UDSV	JMXER1C10**UDSV	JMXEP1C10**UDSV	JMXFD1C10**UDSV	JMXFH1C10**UDSV
D	Orange	JMXHH1D10**UDSO	JMXHC1D10**UDSO	JMXER1D10**UDSO	JMXEP1D10**UDSO	JMXFD1D10**UDSO	JMXFH1D10**UDSO
E	Yellow	JMXHH1E10**UDSJ	JMXHC1E10**UDSJ	JMXER1E10**UDSJ	JMXEP1E10**UDSJ	JMXFD1E10**UDSJ	JMXFH1E10**UDSJ

"**": Gender / Termination

JMX1-10 (10 x Ø 0.5 mm / 10 x Ø 0.019")

Accessories

Receptacle dust cap

Part number
JMXBR1

Plug dust cap

Part number
JMXBF1

JMX1-10 (10 x Ø 0.5 mm / 10 x Ø 0.019")

Contacts

Ø 0.5 mm / Ø 0.019"	Contact type	Plating	Contact locking type	AWG
Solder	Machined	0.5 µm gold over 3 to 5 µm Ni	Fixed	28 and smaller
Crimp	Not available			

For more information see pages 57 to 58

Mated connector length

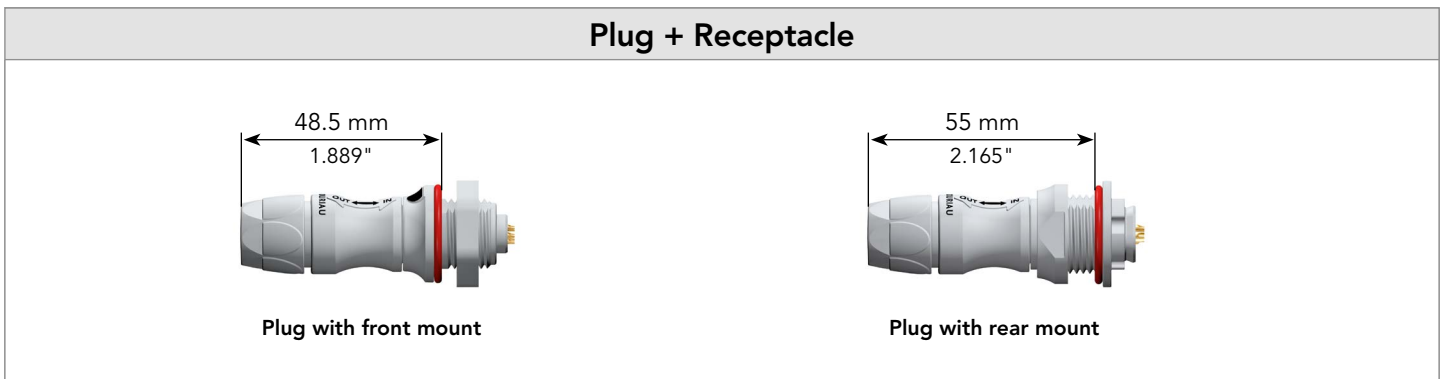

IEC / UL characteristics	
<p>IEC 2.5A 840 Vdc 1.5 kV 2</p>	<p>UL 2.5A 100V UL94 HB</p>

JMX1-12 (12 x Ø 0.5 mm / 12 x Ø 0.019")

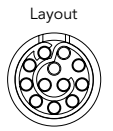

Connector part number (Products without color coding)

Sealing	Contact type	Connector type	Description	Part number		
				Male insert	Female insert	
IP68	Solder contacts see page 53	Receptacle	Front mount, nut fixing (HH) ☁	JMXHH1G12MSUDSU	JMXHH1G12FSUDSU	
			Rear Mount, nut fixing (HC) ☁	JMXHC1G12MSUDSU	JMXHC1G12FSUDSU	
	Plug	Straight plug (FH)	JMXFH1G12MSUDSU	JMXFH1G12FSUDSU		
			Receptacle	Rear Mount, nut fixing (HC) ☁	Please consult us	JMXHC1G12FPUDSU
				Receptacle	Rear Mount, nut fixing (HC) ☁	Please consult us
IP50	Solder contacts see page 53	Receptacle	Front mount, nut fixing (ER)	JMXER1G12MSUDSU	JMXER1G12FSUDSU	
			Rear Mount, nut fixing (EP)	JMXEP1G12MSUDSU	JMXEP1G12FSUDSU	
		Plug	Straight plug (FD)	JMXFD1G12MSUDSU	JMXFD1G12FSUDSU	
	Straight PC Tail see page 59	Receptacle	Rear Mount, nut fixing (EP)	Please consult us	JMXEP1G12FPUDSU	
			Receptacle	Rear Mount, nut fixing (EP)	Please consult us	Please consult us

☁ : Sealed in Unmated Condition

■ : Preferred part numbers with shorter leadtimes

JMX1-12 (12 x Ø 0.5 mm / 12 x Ø 0.019")

Dimensions (For mated connector lengths see page 53)

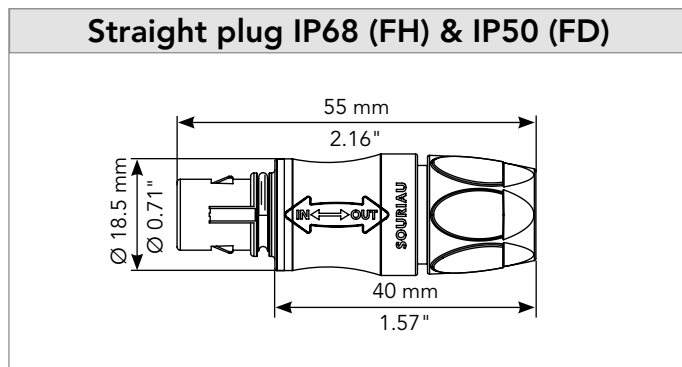
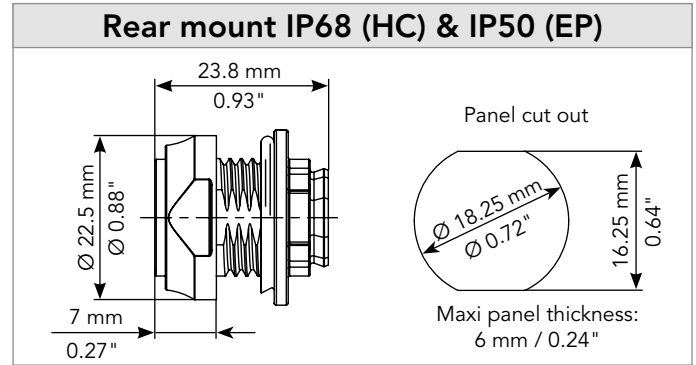
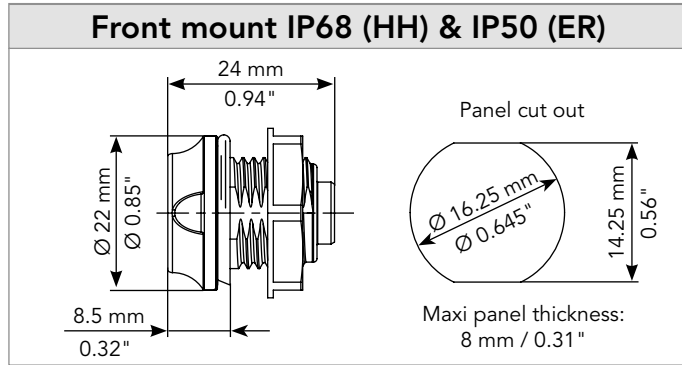

Connector color coding

Coding	Color	Part number ⁽¹⁾					
		Receptacle IP68		Receptacle IP50		Plug IP68	Plug IP50
		Front mount	Rear mount	Front mount	Rear mount	Straight	Straight
G	None	JMXHH1G12**UDSU	JMXHC1G**UDSU	JMXER1G12**UDSU	JMXEP1G12**UDSU	JMXFD1G12**UDSU	JMXFH1G12**UDSU
A	Blue	JMXHH1A12**UDSA	JMXHC1A12**UDSA	JMXER1A12**UDSA	JMXEP1A12**UDSA	JMXFD1A12**UDSA	JMXFH1A12**UDSA
B	Red	JMXHH1B12**UDSR	JMXHC1B12**UDSR	JMXER1B12**UDSR	JMXEP1B12**UDSR	JMXFD1B12**UDSR	JMXFH1B12**UDSR
C	Green	JMXHH1C12**UDSV	JMXHC1C12**UDSV	JMXER1C12**UDSV	JMXEP1C12**UDSV	JMXFD1C12**UDSV	JMXFH1C12**UDSV
D	Orange	JMXHH1D12**UDSO	JMXHC1D12**UDSO	JMXER1D12**UDSO	JMXEP1D12**UDSO	JMXFD1D12**UDSO	JMXFH1D12**UDSO
E	Yellow	JMXHH1E12**UDSJ	JMXHC1E12**UDSJ	JMXER1E12**UDSJ	JMXEP1E12**UDSJ	JMXFD1E12**UDSJ	JMXFH1E12**UDSJ

"**": Gender / Termination

JMX1-12 (12 x Ø 0.5 mm / 12 x Ø 0.019")

Accessories

Receptacle dust cap

Part number
JMXBR1

Plug dust cap

Part number
JMXBF1

JMX1-12 (12 x Ø 0.5 mm / 12 x Ø 0.019")

Contacts

Ø 0.5 mm / Ø 0.019"	Contact type	Plating	Contact locking type	AWG
Solder	Machined	0.5 µm gold over 3 to 5 µm Ni	Fixed	28 and smaller
Crimp	Not available			

For more information see pages 57 to 58

Mated connector length

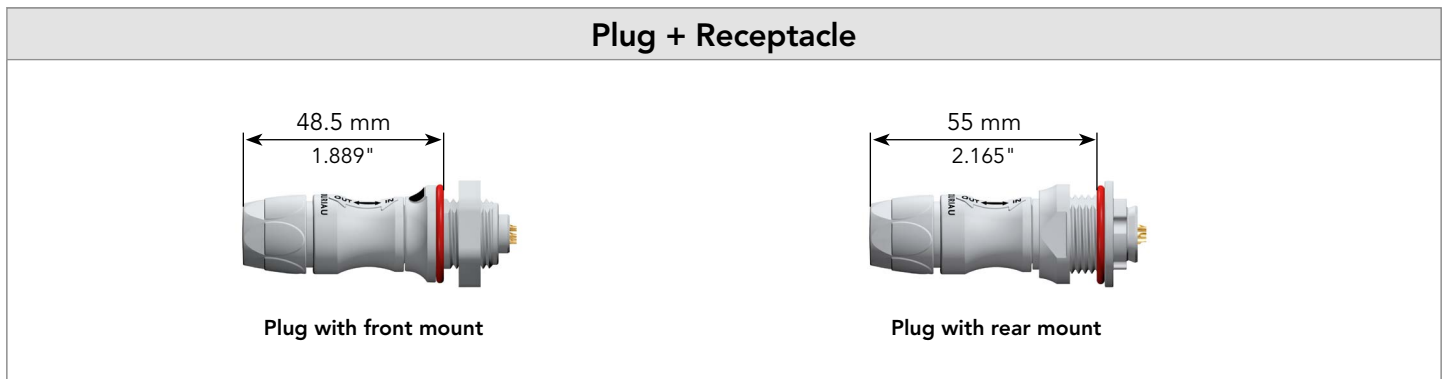

IEC / UL characteristics	
<p>IEC 2.5A 840 Vdc 1.5 kV 2</p>	<p>UL 2.5A 100V UL94 HB</p>

JMX SERIES

Contacts

■ Description	56
■ Packaging	56
■ Solder contacts	57
■ Crimp contacts	58
■ Straight PC tail contacts	59
■ 90° PC tail contacts	60
■ Tooling	61

Contacts

Description

The JMX Series is delivered with golded machined contacts to ensure the 2,000 cycles mating/unmating resistance. SOURIAU contacts are designed for simple snap-in installation and therefore eliminate the need for insertion tooling.

Please note that solder contacts diam 0.7 mm and diam 0.5 mm are not available in spare parts



• Solder



• Crimp



• Straight PC tail



• 90° PC tail

Packaging for contacts. Not available for solder contacts Ø 0.7 mm & Ø 0.5 mm

Due to the wide variety of applications, contact packaging is offered in bulk package.



• 100 pieces loose package

Solder contacts

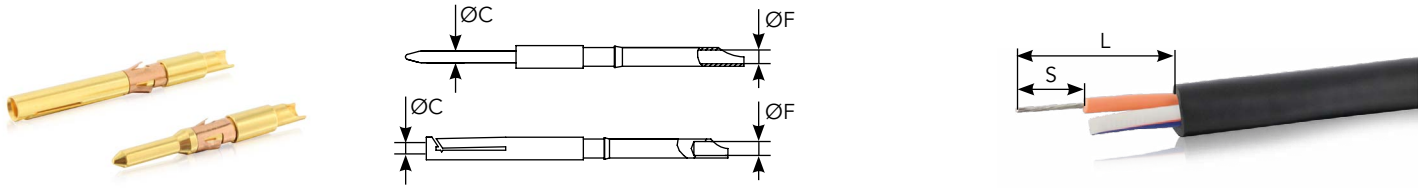

Contact size ØC	ØF		Wire size (Stranded)		Part number		Max current rating (A)
	mm	inch	AWG (maxi)	mm ² (maxi)	Male	Female	
#24 Ø 0.5 mm / Ø 0.019"	0.50	0.019"	28	0.09	Not available	Not available	5
#22 Ø 0.7 mm / Ø 0.027"	0.80	0.031"	22	0.34	Not available	Not available	7
#20 Ø 0.9 mm / Ø 0.035"	0.80	0.031"	22	0.34	JBX1CTMS09	JBX1CTFS09	10
#18 Ø 1.3 mm / Ø 0.051"	1.10	0.043"	20	0.50	JBX1CTMS13	JBX1CTFS13	15

* Part numbers for removal contacts only

Wire stripping instructions

Contact size	L		S	
	mm	inch	mm	inch
#24 Ø 0.5 mm / Ø 0.019"	20	0.790"	2	0.079"
#22 Ø 0.7 mm / Ø 0.027"	20	0.790"	3	0.118"
#20 Ø 0.9 mm / Ø 0.035"	20	0.790"	3	0.118"
#18 Ø 1.3 mm / Ø 0.051"	20	0.790"	3.5	0.138"

Crimp contacts (Not available in Ø 0.5 mm versions)

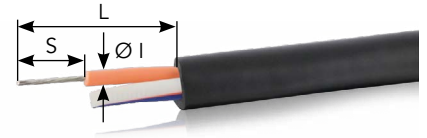
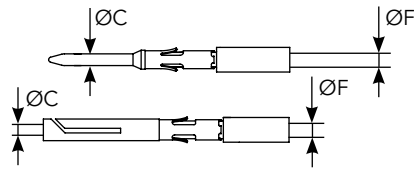

Contact size ØC	ØF		Wire size (Stranded)		Part number*		Max current rating (A)
	mm	inch	AWG (min-maxi)	mm ² (min-maxi)	Male	Female	
#22 Ø 0.7 mm/ Ø 0.027"	0.85	0.033"	26-22	0.14-0.34	JBX1CTMC07	JBX1CTFC07	7
#20 Ø 0.9 mm/ Ø 0.035"	1.10	0.043"	24-20	0.25-0.50	JBX1CTMC09	JBX1CTFC09	10
#18 Ø 1.3 mm/ Ø 0.051"	1.40	0.055"	22-18	0.50-1.00	JBX1CTMC13	JBX1CTFC13	15

* Part numbers for removal contacts only

Wire stripping instructions

Contact size	Ø I (diameter over insulation)		L		S	
	mm	inch	mm	inch	mm	inch
#22 Ø 0.7 mm/ Ø 0.027"	> 1.35	≤ 0.053"	20	0.790"	4	0.157"
	> 1.35	> 0.053"			5.5	0.217"
#20 Ø 0.9 mm/ Ø 0.035"	≤ 1.60	≤ 0.062"	20	0.790"	4	0.157"
	> 1.60	> 0.062"			5.5	0.217"
#18 Ø 1.3 mm/ Ø 0.051"	≤ 2.10	≤ 0.082"	20	0.790"	4	0.157"
	> 2.10	> 0.082"			5.5	0.217"

Straight PC tail contacts

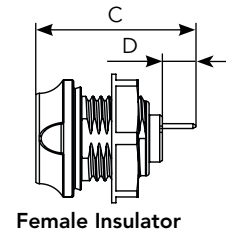
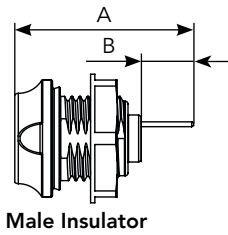

Shell size	Contact size	Layout	Contact range		Max current rating (A)	A	B	C	D
			Male contact	Female contact					
1	#25 Ø 0.5 mm	12	No	Yes	5	-	-	24.0	5.1
		10	No	Yes	5	-	-	24.0	5.1
	#22 Ø 0.7 mm	08	Yes	Yes	7	26.3	5.9	24.3	3.9
		07	Yes	Yes	7	26.3	5.9	24.3	3.9
		06	Yes	Yes	7	26.3	5.9	24.3	3.9
	#20 Ø 0.9 mm	05	No	Yes	10	-	-	24.3	3.9
		04	No	Yes	10	-	-	24.3	3.9
	#18 Ø 1.3 mm	03	No	Yes	15	-	-	24.3	3.9
		02	No	Yes	15	-	-	24.3	3.9

90° PC tail contacts

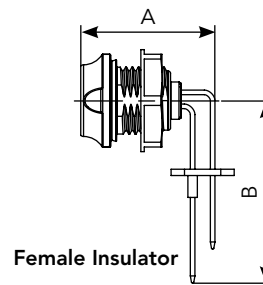

Shell size	Contact size	Layout	Contact range	Max current rating (A)	A	B
			Female contact			
1	#22 Ø 0.7 mm	08	Yes	7	27.6	32.5
		07	Yes	7	27.6	32.4
		06	Yes	7	27.6	32.4
	#20 Ø 0.9 mm	05	Yes	10	27.6	32.1
		04	Yes	10	25.0	31.8
	#18 Ø 1.3 mm	03	Yes	15	25.0	31.5

Tooling

Crimp tool table

Crimp contacts

Contact size	Shell type	Part number*		Crimp tooling	Locator		Extraction tools
		Male	Female		Male	Female	
#22 Ø 0.7 mm/ Ø 0.027"	1	JBX1CTMC07	JBX1CTFC07	M22520/7-01	JBX10UTLP07	JBX10UTLS07	JBXOUTDC07
#20 Ø 0.9 mm/ Ø 0.035"	1	JBX1CTMC09	JBX1CTFC09	M22520/7-01	JBX10UTLP09	JBX10UTLS09	JBXOUTDC09
#18 Ø 1.3 mm/ Ø 0.051"	1	JBX1CTMC13	JBX1CTFC13	M22520/7-01	JBX10UTLP13	JBX10UTLS13	JBXOUTDC13

* Part numbers for removal contacts only

Contact extraction instruction

- Place the tool into the cavity from front face of the insulator
- Push on the handle
- Remove the contact by pulling on it.



JMX SERIES

Technical Information

■ Receptacle assembly instructions	64
■ Plug assembly instructions	65
■ Which Standard to select ?	66
■ UL94 + UL1977	67
■ IEC 61984 & IP codes explained	70
■ What is NEMA Rating ?	72
■ What is CE Marking ?	72
■ Sterilization	73
■ Ethernet for the Layman	74

JMX receptacle assembly instructions

JMXHH - JMXER assembly

- 1) Solder or crimp the wires to the contacts (see pages 57 & 58)
- 2) Check carefully the presence of the o-ring on the receptacle for the JMXHH version
- 3) Place the receptacle in the panel cut out. Make sure the panel thickness is inferior to E maxi
- 4) Screw the hex nut to the bulkhead with a wrench according to the recommended tightening torque
- 5) Insert contacts manually in the cavities for removable contacts versions

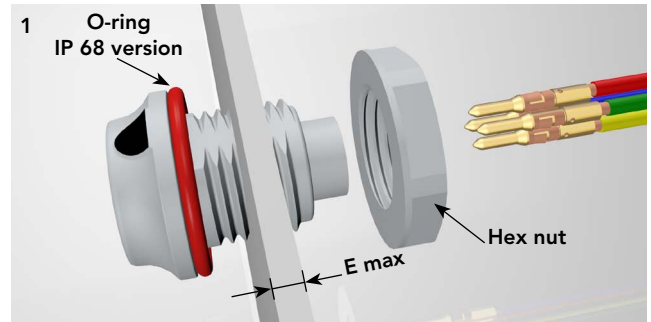

Tightening torque (Nm) maxi	Wrench size	E Panel maxi thicknesses	
		mm	inch
2.5	22 mm	8	0.177"

JMXHC - JMXEP assembly

Solder and crimp versions:

- 1) Solder, crimp the wires to the contacts (see pages 57 & 58)

Straight PC tail & 90° PC Tail:

- 1) Sold the PC tail contacts on the PCB board
- 2) Check carefully the presence of the o-ring on the receptacle for the JMXHC version
- 3) Place the receptacle in the panel cut out. Make sure the panel thickness is inferior to E maxi
- 4) Screw the hex nut to the bulkhead with a wrench according to the recommended tightening torque
- 5) Insert contacts manually in the cavities for removable contacts versions

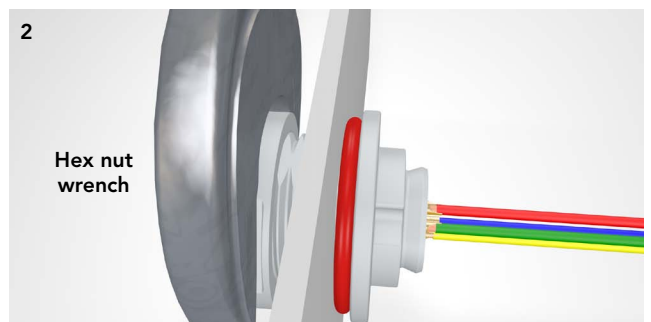
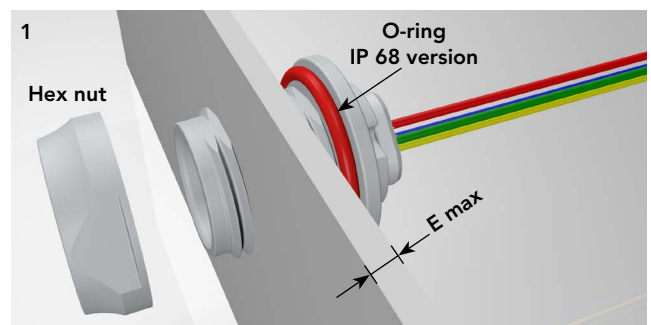

Tightening torque (Nm) maxi	Wrench size	E Panel maxi thicknesses	
		mm	inch
2.5	25 mm	6	0.236"

Note: Assembly operations mentioned above shall not interfere or to be in contradiction with the IPC-WHMA-A-620B

JMX plug assembly instructions (Instruction included in the plug packaging)

JMXFH & JMXFD assembly

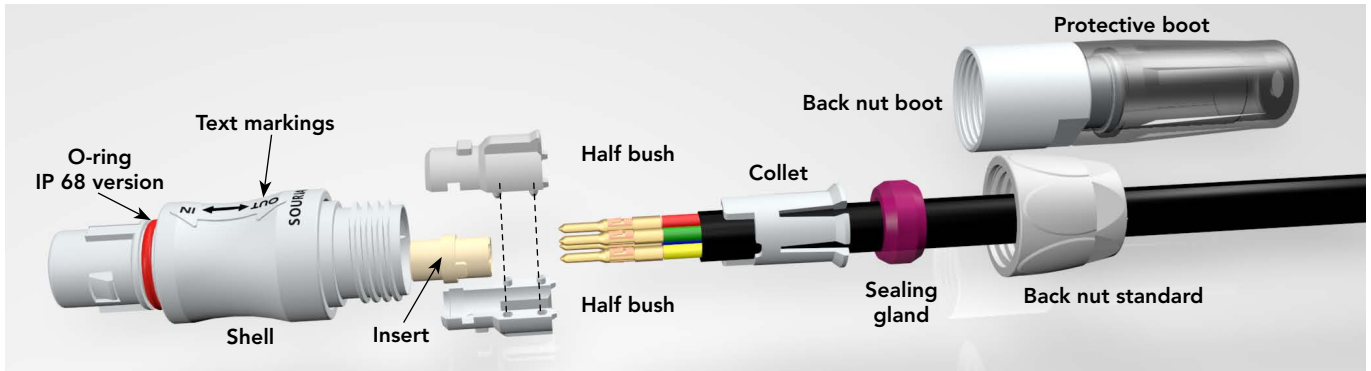

- 1) Slide the backnut, the sealing gland and the collet onto the cable (see "collet & sealing gland selection" table). Strip the external cable jacket and wires (see dimensions pages 57 & 58). Solder or crimp the wires to the contacts (see pages 57 & 58). For removable contacts, insert them manually in the insert.
- 2) Place the insert keyway into the half bushes windows (fig. 2).
- 3) Align the half bushes window with the plug arrow (fig. 3).

- 4) Slide the subassembly until hearing an audible click (fig. 4).
- 5) Slide the collet, the sealing gland and the backnut (fig. 5).
- 6) Apply a torque of 1.5 Nm on the backnut with a wrench size 14 mm (fig. 6).

Collet & sealing gland selection			
Ø cable maxi	Indice	Ø cable maxi	Indice
7.5 mm/0.295"	A	4.8 mm/0.189"	C
6.2 mm/0.242"	B	3.5 mm/0.138"	D

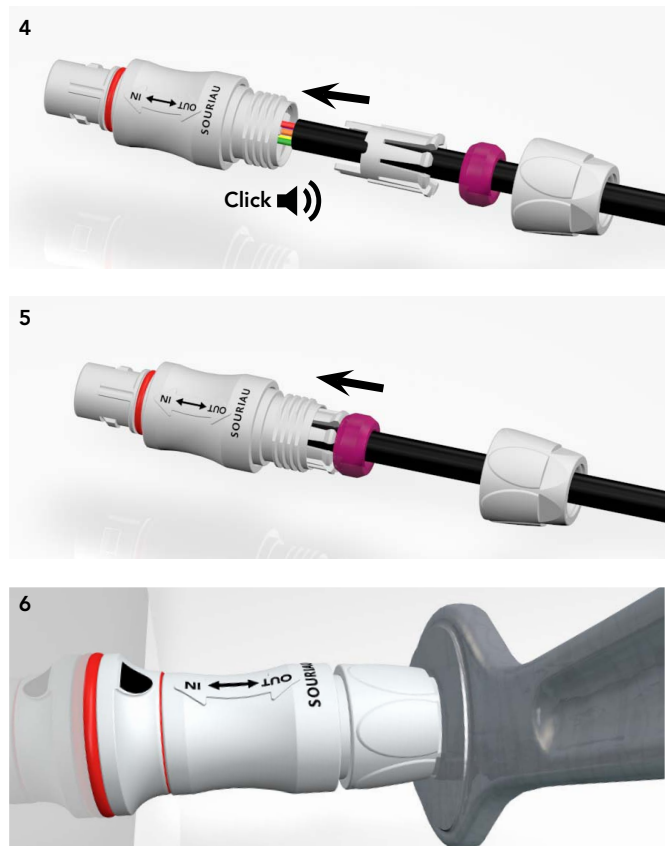
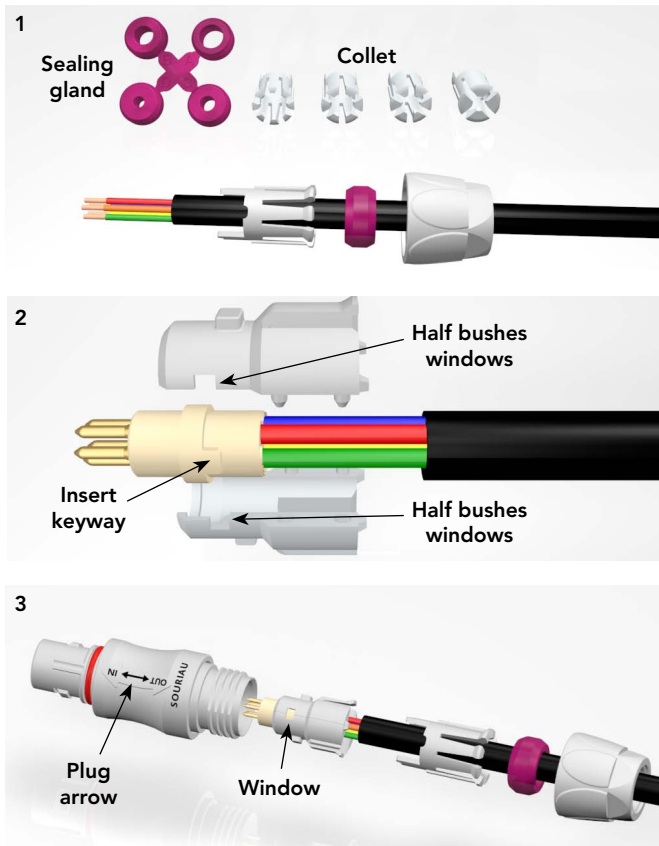

Note: Assembly operations mentioned above shall not interfere or to be in contradiction with the IPC-WHMA-A-620B

Which Standard to select ?

Standard qualification benefits:

Safety and essential performance requirements for "Medical electrical equipments" are defined by the general standard IEC 60601-1.

It is a requirement for the commercialization of electrical medical equipments. Compliance to the IEC 60601-1 requests a qualification to component standards as the connector standards UL 1977 (US) and IEC 61984 (Europe).

It avoids to re-proceed to a full qualification of the connectors and simplifies the equipment qualification process.

JMX connectors are compliant to the UL 1977 and IEC 61984 and therefore ensure a fully compliance with the IEC 60601-1.

IEC 60601-1
General Standard
Medical Electrical Equipment



UL 60601
North America Standard
Medical Electrical Equipment



EN 60601
European Standard
Medical Electrical Equipment



UL 1977 / CSA 22.2
North America Standard



IEC 61984
(SOURIAU relevant standard)
European Connector Standard

UL94 + UL1977

Underwriter laboratories



There are two main standards for industrial connectors: UL94 & UL1977

UL94

This standard is dedicated to plastics flammability. It characterizes how the material burns in various orientation and thicknesses.

The JMX Plastic series is rated at **V-0 for the shell and HB for the insert.**

Procedure: A specimen is supported in a vertical or horizontal position and a flame is applied to the bottom of the specimen. The flame is applied for ten seconds and then removed until flaming stops, at which time the flame is reapplied for another ten seconds and then removed. Two sets of five specimens are tested.

More details on the Flammability UL 94 could be found on the following link:
www.ultrc.com/en/solutions/test-methods/combustion-fire.html

V-0 Vertical burning:

- Specimens must not burn with flaming combustion for more than 10 seconds after each test flame application
- Total flaming combustion time must not exceed 50 seconds for each set of 5 specimens
- Specimens must not burn with flaming or glowing combustion up to the specimen holding clamp
- Specimens must not drip flaming particles that ignite the cotton
- No specimen can have glowing combustion remain for longer than 30 seconds after removal of the test flame.

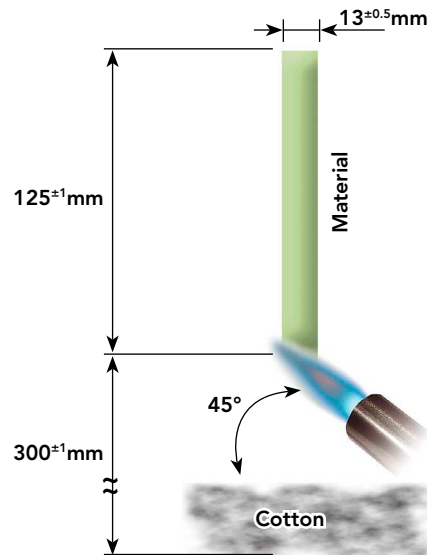

HB Horizontal burning:

- A material classified HB shall not have a burning rate exceeding 40mm per minute over a 75mm span for specimens having a thickness of 3.0 to 13mm
- A material classified HB shall not have a burning rate exceeding 75mm per minute over a 75mm span for specimens having a thickness less than 3.0mm
- A material classified HB shall cease to burn before the 100mm reference mark.

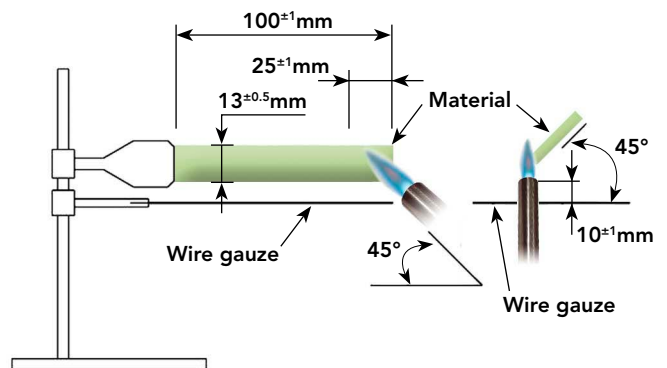

UL94 + UL1977



UL1977

The connector standard UL1977 covers single and multipole connectors intended for factory assembly. Requirements apply to devices taking into account intensity and voltage. The categories are as follow:

	0	30 V (42 V peak)	600 V	6000 V
0	Type 0	Type 1A	Type 5	
8.3 A				
31 A	Type 1B	Type 2	Type 5	
200 A		Type 3		
1000 A	Type 4			

According to above table, the level of performance to be reached could be different. Most of them are explained in the following page.

Insulating materials:

For all the types described in the above table, JMX inserts are rated HB and have a RTI of 130°C / 266°F.

Assembly:

Connector has to be keyed to prevent any mismatching that can damage the machine or hurt the user. In the same way, plugs and sockets have to be equipped to protect persons against contact with live parts.

UL94 + UL1977



UL1977

Spacing / Dielectric Withstanding Voltage:

UL1977 defines minimum clearance and creepage distances for voltage below and above 250V. An alternative way to determine voltage rating is the Dielectric Withstanding Voltage (DWW) test. No arc-over or breakdown must occur during one minute.

Different Dielectric Withstanding Voltage requirements shall be considered depending on the connector type. DWW requirement are shown in the table below.

• **Applicability of spacing requirements**

Type	Current rating (A)	U=Voltage rating (Vrms)	Dielectric Withstanding Voltage requirement to considered (during 1 minute)
0	0 to 8.3	0 to 30	No requirement for type 0
1A	0 to 8.3	30 to 600	2U+1,000
1B	8.3 to 200	0 to 30	500V Minimum
2	8.3 to 31	30 to 600	2U+1,000
3	31 to 200	30 to 600	2U+1,000
4	200 to 1,000	0 to 600	2U+1,000
5	0 to 31	600 to 6,000	2,200V Minimum

Marking:

A device shall be legibly marked with the manufacturer's trade name, trade mark, or other descriptive marking by which the organization responsible for the product may be identified. (Exception: If the device is too small, or where the legibility would be difficult to attain, the manufacturer's name, trademark, or other descriptive marking may appear on the smallest unit container or carton)

The following shall be marked on the device or on the smallest unit container or carton or on a stuffer sheet in the smallest unit container or carton:

- a) The catalog number or an equivalent designation
- b) The electrical rating in both volts and amperes, if assigned
- c) Whether ac or dc, if restricted
- d) Flammability class, if identified

Example - Marking for the 2 contacts layout:

10A 300V UL94 HB

IEC 61984 & IP codes explained

IEC 61984

This standard is dedicated to connectors with rated voltage above 50V and up to 1000V and rated currents up to 125A per contact. Depending on your application connectors should be compliant with another standard. This has to be double checked with the customer.

There are a lot of constructional requirements and performances specified in that standard. Most of them are illustrated in greater details hereafter.

IP code:

IP is a coding system defined by the IEC 60529 to indicate the degrees of protection provided by an enclosure. The aim of this is to give information regarding the accessibility of live parts against ingress of water and other foreign bodies.

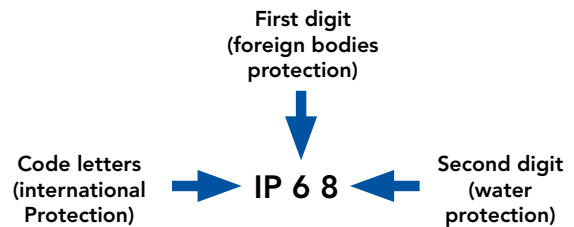

1 st digit	Degree of protection	2 nd digit	Degree of protection
0	No protection against accidental contact. No protection against solid foreign bodies.	0	No protection against water.
1	Protection against contact with any large area by hand and against large solid foreign bodies with a diameter bigger than 50 mm.	1	Drip-proof. Protection against vertical water drips.
2	Protection against contact with the fingers. Protection against solid foreign bodies with a diameter bigger than 12 mm.	2	Drip-proof. Protection against water drips up to a 15° angle.
3	Protection against tools, wires or similar objects with a diameter bigger than 2.5 mm. Protection against small solid bodies with a diameter bigger than 2.5 mm.	3	Spray-proof. Protection against diagonal water drips up to a 60° angle.
4	Same as 3 however diameter is bigger than 1 mm.	4	Splash-proof. Protection against splashed water from all directions.
5	Full protection against contact. Protection against interior injurious dust deposits.	5	Hose-proof. Protection against water (out of a nozzle) from all directions.
6	Total protection against contact. Protection against penetration of dust.	6	Protection against temporary flooding.
		7	Protection against temporary immersions.
		8	Protection against water pressure. Pressure to be specified by supplier.

JMX offers high sealing performance IP68 (1bar during 1 week):

- In mated condition Plug + Receptacle
- In mated condition with the caps
- In unmated condition for solder Receptacles

IEC 61984 ed.2.0 "Copyright © 2008 IEC Geneva, Switzerland.www.iec.ch"
IEC 60664-1 ed.2.0 "Copyright © 2007 IEC Geneva, Switzerland.www.iec.ch"

IEC 61984 & IP codes explained

IEC 61984

Overvoltage

Per the IEC 60664-1 (formerly VDE 0110) each category is linked to the end application and where the device will be implemented:

- **Category IV** (primary overcurrent protection equipment):
Origin of the installation
- **Category III** (Any fixed installation with a permanent connection)
Fixed installation and equipment and for cases where the reliability and the availability is subject to special requirements
- **Category II** (Domestic appliances):
Energy consuming equipment to be supplied from the fixed installation
- **Category I** (Protected electronic circuit):
For connection to circuit in which measures are taken to limit transient overvoltage.

The "Nominal Voltage" will define for what category JMX connectors could be used. The "Rated Impulse voltage" of the JMX is 1500V. Below a table showing the applicable categories:

Nominal voltage of the supply system based on IEC 60038		Voltage line to neutral derived from nominal voltages a.c. or d.c. up to and including V	Rated impulse voltage			
Three phase	Single phase		Overvoltage category (V)			
			I	II	III	IV
		50	330	500	800	1,500
		100	500	800	1,500	2,500
	120-240	150	800	1,500	2,500	4,000
230/400 277/480		300	1,500	2,500	4,000	6,000
400/690		600	2,500	4,000	6,000	8,000
1,000		1,000	4,000	6,000	8,000	12,000

■ Nominal Voltage ■ Rated Impulse Voltage ■ Non recommended voltage

Pollution degree

Per the IEC 60664-1 (formerly VDE 0110) the environment affects the performance of the insulation. Particles can build a bridge between two metal parts. As a rule dust mixed with water can be conductive and more generally speaking metal dust is conductive. Finally, the standard defines 4 levels of pollution:

- **Degree 1** (Air conditioned dry room):
No pollution or only dry, non conductive pollution occurs. The pollution has no influence.
- **Degree 2** (Personal computer in a residential area):
Only non conductive pollution occurs except that occasionally a temporary conductivity caused by condensation is to be expected.
- **Degree 3** (Machine tools):
Conductive pollution occurs or dry non-conductive pollution occurs which becomes conductive due to condensation which is to be expected.
- **Degree 4** (Equipments on roof, locomotives):
Continuous conductivity occurs due to conductive dust, rain or other wet conditions.

Finally, the harsher the environment is, the longer clearance and creepage distances should be.

Marking

The marking should give enough details to the user to know what the main characteristics are and without going deep in technical documentation. Below is an example of how JMX packagings are marked.

Rated current 10A, working voltage 840 Vdc, rated Impulse voltage 1.5kV, Pollution degree 2

10A 840 Vdc 1.5 kV 2

What is NEMA Rating ?

- NEMA ratings vs IP ratings

Whereas IP ratings only consider protection against ingress of foreign bodies (first digit) and ingress of water (second digit), NEMA ratings consider these but also verify protection from external ice, corrosive materials, oil immersion, etc.

The correlation between NEMA & IP being limited only to dust and water, we can state that a NEMA type is equivalent to an IP rating but it is not possible to say the contrary.

Below a list of some NEMA standards:

Enclosure rating	IP20	IP22	IP55	IP64	IP65	IP66	IP67	IP68
Type 1	•							
Type 3				•				
Type 3R		•						
Type 3S				•				
Type 4						•		
Type 4X						•		
Type 6							•	
Type 6P								•
Type 12			•					
Type 13					•			

• indicates compliance



Type 6 rating can be either Type 6 or Type 6P - please see below:

6	IP67	Enclosures constructed for either indoor or outdoor use to provide a degree of protection to personnel against incidental contact with the enclosed equipment, falling dirt, hose-directed water, the entry of water during occasional temporary submersion at a limited depth and damage from external ice formation.
6P	IP68	Enclosures constructed for either indoor or outdoor use to provide a degree of protection to personnel against incidental contact with the enclosed equipment, falling dirt, hose-directed water, the entry of water during prolonged submersion at a limited depth and damage from external ice formation.

What is C€ Marking ?

CE marking means that the device complies with the European safety directives.

CE marking **does not apply to components such as connectors** but only on complete equipment.

Sterilization

Steam autoclave sterilization:

JMX connectors withstand up to 200 cycles on steam autoclave sterilization according to gravitation or pre-vacuum process per EN13060.

Both processes are described below:

- Gravity process: Steam displaces air in the chamber by gravity through a drain port.
- Pre-vacuum process: The air is removed from the chamber and steam is injected through a series of vacuum and pressure pulses. This allows the steam to penetrate porous areas of the load that could not otherwise be reached with simple gravity displacement.

Cycle is defined at 134°C / 273.2°F during 4 min.

JMX is qualified to ensure a Sterility Assurance Level (SAL) of 10^{-6} for re-usable medical devices sterilized according to ISO 14937 & ISO 17665-1 with a pre-vacuum process.

For other sterilization processes, please contact us.

SOURIAU is equipped with autoclave devices to proceed with additional tests if needed.



Ethernet for the Layman

In order to explain basic Ethernet theory, we can use a functional comparison to a busy city with highways, buildings and cars. To illustrate this, the table below provides correlation between the different components/pieces/links that encompass Ethernet network connectivity, and the larger scale infrastructure of a metropolitan city.

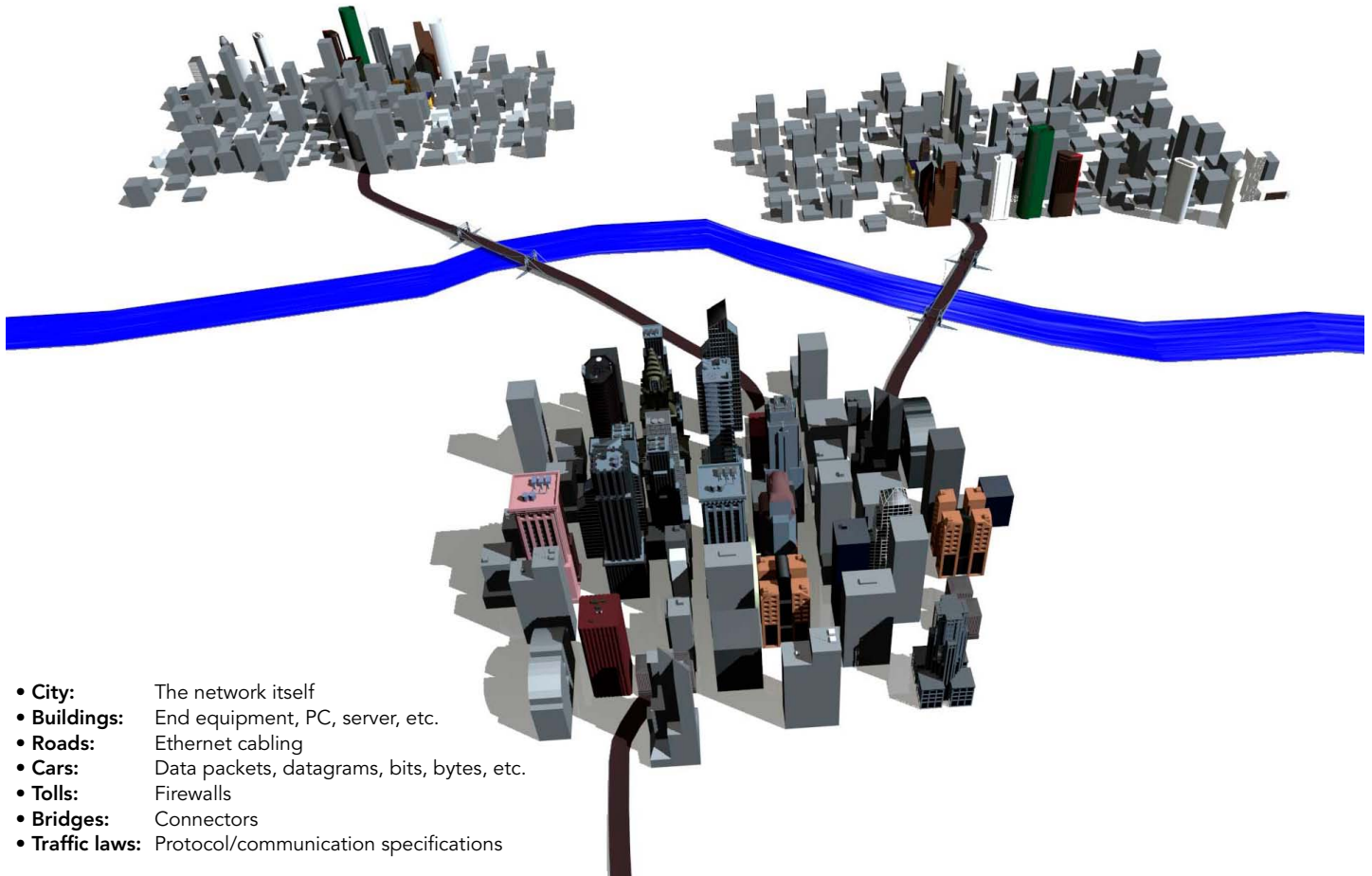

- **City:** The network itself
- **Buildings:** End equipment, PC, server, etc.
- **Roads:** Ethernet cabling
- **Cars:** Data packets, datagrams, bits, bytes, etc.
- **Tolls:** Firewalls
- **Bridges:** Connectors
- **Traffic laws:** Protocol/communication specifications

Ethernet Basics

Ethernet is a widely used communications protocol that is used to transmit data packets (datagrams) between network devices. Imagine a highway in a large metropolitan area six lanes wide at rush hour. The vehicles on the highway need rules to follow so that they get to their destination without crashing into each other. In an Ethernet network link, there could be 100 million bits of information transmitted in one second. In the Ethernet standard, there exist rules to govern packet structure, transmission requirements, error correction, communication with end equipment, etc.

Examining the differences between 100Mhz, 100 Base TX, Cat5e/Cat6. What does it all mean?

When discussing connectors and Ethernet, there are a few key details to be aware of:

- 100Mhz is a measurement of Frequency for the signal
 - Comparable to the Speed Limit of a highway
- 100BaseTX (or Fast Ethernet) is an Ethernet link standard and identifies available link bandwidth. The bandwidth is measured in units of Mbits/S (megabits per second)
 - Comparable to the number of cars that pass a point in one second
- Cat5e/Cat6 are an EIA/TIA standard for performance and physical characteristics for cables and connectors
 - Comparable to performance specifications of the car and highway.

In connectors and cables, Fast Ethernet uses 2 pairs. One for transmit and one for receive. This way data traffic can flow in both directions simultaneously.

Notes

A large grid area for taking notes, consisting of 20 columns and 30 rows of small squares.

JMX SERIES

Appendices

■ Glossary of Terms	78
■ Safety notice	79
■ Part Number Index	80



Glossary of terms

- **Clearance**

Per the IEC 60664-1 it is the shortest distance between two conductive parts even over the air.

- **Creepage distance**

Per the IEC 60664-1 it represents the shortest distance along the surface of the insulating material between two conductive parts.

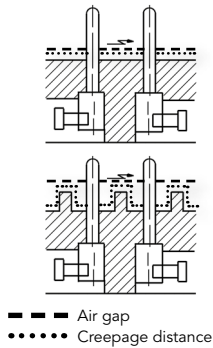

- **Test Voltage**

Measured according to the IEC 60512-2 test 4a, Test voltage corresponds to 75% of the mean dielectric withstanding voltage.

Operating voltage: It could be calculated following the method:

$$\frac{\text{Test Voltage}}{3}$$

- **Rated impulse voltage**

Impulse withstands voltage value assigned by the manufacturer to the equipment or to a part of it characterizing the specified withstand capability of its insulation against transient overvoltage.

- **Working current**

It is the maximum continuous and not interrupted current able to be carried by all contacts without exceeding the maximum temperature of the insulating material.

- **Transient voltage**

Extract from the IEC 60664-1: Short duration overvoltage of a few millisecond or less, oscillatory or non-oscillatory, usually highly damped.

- **CTI (Comparative Tracking Index)**

The CTI value is commonly used to characterize the electrical breakdown properties of an insulating material. It allows users to know the tendency to create creepage paths. This value represents the maximum voltage after 50 drops of ammonium chloride solution without any breakdown.

- **RTI (Relative temperature Index):**

Extract from ULs website:

Maximum service temperature for a material, where a class of critical property will not be unacceptably compromised through chemical thermal degradation, over the reasonable life of an electrical product, relative to a reference material having a confirmed, acceptable corresponding performance defined RTI.

- **RTI Elec:** Electrical RTI, associated with critical electrical insulating properties.
- **RTI Mech Imp:** Mechanical Impact RTI, associated with critical impact resistance, resilience and flexibility properties.
- **RTI Mech Str:** Mechanical Strength (Mechanical without Impact) RTI, associated with critical mechanical strength where impact resistance, resilience and flexibility are not essential.

Safety notice

Please read and follow all instructions carefully. Relevant national and international safety regulations must be considered for your application. Improper use of connectors can result in hazardous situations.

1 - Electrical safety

Short circuits, overheating, risk of electrical shock could be generated for the following situations:

- Improper mating of the connector
- Incorrect wiring
- Presence of foreign objects such as metal debris or liquid residue
- Damaged components

Mated components should never be disconnected while live as this may result in an exposed electric arc and local overheating, resulting in possible damage to components.

Connectors with exposed electrical contacts should never be installed on the live side of the circuit. Under normal conditions voltages above 30 VAC/42 VDC are considered dangerous and proper precautions should be taken to eliminate all risk of transmission of such voltages to any exposed metal part of the connector

The maximum admissible operating voltage depends upon the national or international standards in force for the application in question. Air and creepage distances impact the operating voltage; reference values are indicated in the catalog however these may be influenced by PC board design and / or wiring harnesses.

2 - Installation

Esterline - SOURIAU cannot ensure the correct functionality of the connectors if proper tools are not used for the installation/assembly.

Connectors shall remain packaged before use to maintain their technical characteristics.

Connectors and their components should be visually inspected for damage prior to installation and assembly.

Connector assembly and installation should only be carried out by properly trained personnel.

JMX connectors are not intended to be implanted into the human body.

3 - CE marking

CE marking means that the device complies with the European safety directives.

CE marking does not apply to components such as connectors but only on complete equipment.

4 - Product improvements

Esterline - SOURIAU reserves the right to modify and improve our products or specifications without providing prior notification.

5 - Lubrication

O-rings are pre-lubricated before delivery and can result in lubrication traces on the connector.

6 - Product return

SOURIAU cannot accept any product return that may be contaminated.

Part number index

Connectors

JMXEP1G02FCUDSU.....	P. 18	JMXER1G02FCUDSU.....	P. 18	JMXFH1G02FSUDSU.....	P. 18
JMXEP1G02FPUDSU.....	P. 18	JMXER1G02FSUDSU.....	P. 18	JMXFH1G02MCUDSU.....	P. 18
JMXEP1G02FQUDSU.....	P. 18	JMXER1G02MCUDSU.....	P. 18	JMXFH1G02MSUDSU.....	P. 18
JMXEP1G02FSUDSU.....	P. 18	JMXER1G02MSUDSU.....	P. 18	JMXFH1G03FCUDSU.....	P. 22
JMXEP1G02MCUDSU.....	P. 18	JMXER1G03FCUDSU.....	P. 22	JMXFH1G03FSUDSU.....	P. 22
JMXEP1G02MPUDSU.....	P. 18	JMXER1G03FSUDSU.....	P. 22	JMXFH1G03MCUDSU.....	P. 22
JMXEP1G02MQUDSU.....	P. 18	JMXER1G03MCUDSU.....	P. 22	JMXFH1G03MSUDSU.....	P. 22
JMXEP1G02MSUDSU.....	P. 18	JMXER1G03MSUDSU.....	P. 22	JMXFH1G04FCUDSU.....	P. 26
JMXEP1G03FCUDSU.....	P. 22	JMXER1G04FCUDSU.....	P. 26	JMXFH1G04FSUDSU.....	P. 26
JMXEP1G03FPUDSU.....	P. 22	JMXER1G04FSUDSU.....	P. 26	JMXFH1G04MCUDSU.....	P. 26
JMXEP1G03FQUDSU.....	P. 22	JMXER1G04MCUDSU.....	P. 26	JMXFH1G04MSUDSU.....	P. 26
JMXEP1G03FSUDSU.....	P. 22	JMXER1G04MSUDSU.....	P. 26	JMXFH1G05FCUDSU.....	P. 30
JMXEP1G03MCUDSU.....	P. 22	JMXER1G05FCUDSU.....	P. 30	JMXFH1G05FSUDSU.....	P. 30
JMXEP1G03MPUDSU.....	P. 22	JMXER1G05FSUDSU.....	P. 30	JMXFH1G05MCUDSU.....	P. 30
JMXEP1G03MQUDSU.....	P. 22	JMXER1G05MCUDSU.....	P. 30	JMXFH1G05MSUDSU.....	P. 30
JMXEP1G03MSUDSU.....	P. 22	JMXER1G05MSUDSU.....	P. 30	JMXFH1G06FCUDSU.....	P. 34
JMXEP1G04FCUDSU.....	P. 26	JMXER1G06FCUDSU.....	P. 34	JMXFH1G06FSUDSU.....	P. 34
JMXEP1G04FPUDSU.....	P. 26	JMXER1G06FSUDSU.....	P. 34	JMXFH1G06MCUDSU.....	P. 34
JMXEP1G04FQUDSU.....	P. 26	JMXER1G06MCUDSU.....	P. 34	JMXFH1G06MSUDSU.....	P. 34
JMXEP1G04FSUDSU.....	P. 26	JMXER1G06MSUDSU.....	P. 34	JMXFH1G07FCUDSU.....	P. 38
JMXEP1G04MCUDSU.....	P. 26	JMXER1G07FCUDSU.....	P. 38	JMXFH1G07FSUDSU.....	P. 38
JMXEP1G04MPUDSU.....	P. 26	JMXER1G07FSUDSU.....	P. 38	JMXFH1G07MCUDSU.....	P. 38
JMXEP1G04MQUDSU.....	P. 26	JMXER1G07MCUDSU.....	P. 38	JMXFH1G07MSUDSU.....	P. 38
JMXEP1G04MSUDSU.....	P. 26	JMXER1G07MSUDSU.....	P. 38	JMXFH1G08FCUDSU.....	P. 42
JMXEP1G05FCUDSU.....	P. 30	JMXER1G08FCUDSU.....	P. 42	JMXFH1G08FSUDSU.....	P. 42
JMXEP1G05FPUDSU.....	P. 30	JMXER1G08FSUDSU.....	P. 42	JMXFH1G08MCUDSU.....	P. 42
JMXEP1G05FQUDSU.....	P. 30	JMXER1G08MCUDSU.....	P. 42	JMXFH1G08MSUDSU.....	P. 42
JMXEP1G05FSUDSU.....	P. 30	JMXER1G08MSUDSU.....	P. 42	JMXFH1G10FSUDSU.....	P. 46
JMXEP1G05MCUDSU.....	P. 30	JMXER1G10FSUDSU.....	P. 46	JMXFH1G10MSUDSU.....	P. 46
JMXEP1G05MPUDSU.....	P. 30	JMXER1G10MSUDSU.....	P. 46	JMXFH1G12FSUDSU.....	P. 50
JMXEP1G05MQUDSU.....	P. 30	JMXER1G12FSUDSU.....	P. 50	JMXFH1G12MSUDSU.....	P. 50
JMXEP1G05MSUDSU.....	P. 30	JMXER1G12MSUDSU.....	P. 50	JMXFD1G02FCUDSU.....	P. 18
JMXEP1G06FCUDSU.....	P. 34	JMXFD1G02FCUDSU.....	P. 18	JMXFD1G02FSUDSU.....	P. 18
JMXEP1G06FPUDSU.....	P. 34	JMXFD1G02FSUDSU.....	P. 18	JMXFD1G02MCUDSU.....	P. 18
JMXEP1G06FQUDSU.....	P. 34	JMXFD1G02MCUDSU.....	P. 18	JMXFD1G02MSUDSU.....	P. 18
JMXEP1G06FSUDSU.....	P. 34	JMXFD1G02MSUDSU.....	P. 18	JMXFD1G03FCUDSU.....	P. 22
JMXEP1G06MCUDSU.....	P. 34	JMXFD1G03FCUDSU.....	P. 22	JMXFD1G03FSUDSU.....	P. 22
JMXEP1G06MPUDSU.....	P. 34	JMXFD1G03FSUDSU.....	P. 22	JMXFD1G03MCUDSU.....	P. 22
JMXEP1G06MQUDSU.....	P. 34	JMXFD1G03MCUDSU.....	P. 22	JMXFD1G03MSUDSU.....	P. 22
JMXEP1G06MSUDSU.....	P. 34	JMXFD1G03MSUDSU.....	P. 22	JMXFD1G04FCUDSU.....	P. 26
JMXEP1G07FCUDSU.....	P. 38	JMXFD1G04FCUDSU.....	P. 26	JMXFD1G04FSUDSU.....	P. 26
JMXEP1G07FPUDSU.....	P. 38	JMXFD1G04FSUDSU.....	P. 26	JMXFD1G04MCUDSU.....	P. 26
JMXEP1G07FQUDSU.....	P. 38	JMXFD1G04MCUDSU.....	P. 26	JMXFD1G04MSUDSU.....	P. 26
JMXEP1G07FSUDSU.....	P. 38	JMXFD1G04MSUDSU.....	P. 26	JMXFD1G05FCUDSU.....	P. 30
JMXEP1G07MCUDSU.....	P. 38	JMXFD1G05FCUDSU.....	P. 30	JMXFD1G05FSUDSU.....	P. 30
JMXEP1G07MPUDSU.....	P. 38	JMXFD1G05FSUDSU.....	P. 30	JMXFD1G05MCUDSU.....	P. 30
JMXEP1G07MQUDSU.....	P. 38	JMXFD1G05MCUDSU.....	P. 30	JMXFD1G05MSUDSU.....	P. 30
JMXEP1G07MSUDSU.....	P. 38	JMXFD1G05MSUDSU.....	P. 30	JMXFD1G06FCUDSU.....	P. 34
JMXEP1G08FCUDSU.....	P. 42	JMXFD1G06FCUDSU.....	P. 34	JMXFD1G06FSUDSU.....	P. 34
JMXEP1G08FPUDSU.....	P. 42	JMXFD1G06FSUDSU.....	P. 34	JMXFD1G06MCUDSU.....	P. 34
JMXEP1G08FQUDSU.....	P. 42	JMXFD1G06MCUDSU.....	P. 34	JMXFD1G06MSUDSU.....	P. 34
JMXEP1G08FSUDSU.....	P. 42	JMXFD1G06MSUDSU.....	P. 34	JMXFD1G07FCUDSU.....	P. 38
JMXEP1G08MCUDSU.....	P. 42	JMXFD1G07FCUDSU.....	P. 38	JMXFD1G07FSUDSU.....	P. 38
JMXEP1G08MPUDSU.....	P. 42	JMXFD1G07FSUDSU.....	P. 38	JMXFD1G07MCUDSU.....	P. 38
JMXEP1G08MQUDSU.....	P. 42	JMXFD1G07MCUDSU.....	P. 38	JMXFD1G07MSUDSU.....	P. 38
JMXEP1G08MSUDSU.....	P. 42	JMXFD1G07MSUDSU.....	P. 38	JMXFD1G08FCUDSU.....	P. 42
JMXEP1G10FPUDSU.....	P. 46	JMXFD1G08FCUDSU.....	P. 42	JMXFD1G08FSUDSU.....	P. 42
JMXEP1G10FSUDSU.....	P. 46	JMXFD1G08FSUDSU.....	P. 42	JMXFD1G08MCUDSU.....	P. 42
JMXEP1G10MPUDSU.....	P. 46	JMXFD1G08MCUDSU.....	P. 42	JMXFD1G08MSUDSU.....	P. 42
JMXEP1G10MQUDSU.....	P. 46	JMXFD1G08MSUDSU.....	P. 42	JMXFD1G10FSUDSU.....	P. 46
JMXEP1G10MSUDSU.....	P. 46	JMXFD1G10FSUDSU.....	P. 46	JMXFD1G10MSUDSU.....	P. 46
JMXEP1G12FPUDSU.....	P. 50	JMXFD1G10MSUDSU.....	P. 46	JMXFD1G12FSUDSU.....	P. 50
JMXEP1G12FSUDSU.....	P. 50	JMXFD1G12FSUDSU.....	P. 50	JMXFD1G12MSUDSU.....	P. 50
JMXEP1G12MPUDSU.....	P. 50	JMXFD1G12MSUDSU.....	P. 50	JMXFH1G02FCUDSU.....	P. 18
JMXEP1G12MSUDSU.....	P. 50	JMXFH1G02FCUDSU.....	P. 18	JMXFH1G02FSUDSU.....	P. 18

Part number index

JMXHC1G06FQUDSU.....	P. 34
JMXHC1G06FSUDSU.....	P. 34
JMXHC1G06MCUDSU.....	P. 34
JMXHC1G06MPUDSU.....	P. 34
JMXHC1G06MQUDSU.....	P. 34
JMXHC1G06MSUDSU.....	P. 34
JMXHC1G07FCUDSU.....	P. 38
JMXHC1G07FPUDSU.....	P. 38
JMXHC1G07FQUDSU.....	P. 38
JMXHC1G07FSUDSU.....	P. 38
JMXHC1G07MCUDSU.....	P. 38
JMXHC1G07MPUDSU.....	P. 38
JMXHC1G07MQUDSU.....	P. 38
JMXHC1G07MSUDSU.....	P. 38
JMXHC1G08FCUDSU.....	P. 42
JMXHC1G08FPUDSU.....	P. 42
JMXHC1G08FQUDSU.....	P. 42
JMXHC1G08FSUDSU.....	P. 42
JMXHC1G08MCUDSU.....	P. 42
JMXHC1G08MPUDSU.....	P. 42
JMXHC1G08MQUDSU.....	P. 42
JMXHC1G08MSUDSU.....	P. 42
JMXHC1G10FPUDSU.....	P. 46
JMXHC1G10FSUDSU.....	P. 46
JMXHC1G10MPUDSU.....	P. 46
JMXHC1G10MSUDSU.....	P. 46
JMXHC1G12FPUDSU.....	P. 50
JMXHC1G12FSUDSU.....	P. 50
JMXHC1G12MPUDSU.....	P. 50
JMXHC1G12MSUDSU.....	P. 50
JMXHH1G02FCUDSU.....	P. 18
JMXHH1G02FSUDSU.....	P. 18
JMXHH1G02MCUDSU.....	P. 18
JMXHH1G02MSUDSU.....	P. 18
JMXHH1G03FCUDSU.....	P. 22
JMXHH1G03FSUDSU.....	P. 22
JMXHH1G03MCUDSU.....	P. 22
JMXHH1G03MSUDSU.....	P. 22
JMXHH1G04FCUDSU.....	P. 26
JMXHH1G04FSUDSU.....	P. 26
JMXHH1G04MCUDSU.....	P. 26
JMXHH1G04MSUDSU.....	P. 26
JMXHH1G05FCUDSU.....	P. 30
JMXHH1G05FSUDSU.....	P. 30
JMXHH1G05MCUDSU.....	P. 30
JMXHH1G05MSUDSU.....	P. 30
JMXHH1G06FCUDSU.....	P. 34
JMXHH1G06FSUDSU.....	P. 34
JMXHH1G06MCUDSU.....	P. 34
JMXHH1G06MSUDSU.....	P. 34
JMXHH1G07FCUDSU.....	P. 38
JMXHH1G07FSUDSU.....	P. 38
JMXHH1G07MCUDSU.....	P. 38
JMXHH1G07MSUDSU.....	P. 38
JMXHH1G08FCUDSU.....	P. 42
JMXHH1G08FSUDSU.....	P. 42
JMXHH1G08MCUDSU.....	P. 42
JMXHH1G08MSUDSU.....	P. 42
JMXHH1G10FSUDSU.....	P. 46
JMXHH1G10MSUDSU.....	P. 46
JMXHH1G12FSUDSU.....	P. 50
JMXHH1G12MSUDSU.....	P. 50

Accessories

JBXBF1.....	P. 20
JBXBR1.....	P. 20

Contacts

JBX1CTFC07.....	P. 58
JBX1CTFC09.....	P. 58
JBX1CTFC13.....	P. 58
JBX1CTFS09.....	P. 57
JBX1CTFS13.....	P. 57
JBX1CTMC07.....	P. 58
JBX1CTMC09.....	P. 58
JBX1CTMC13.....	P. 58
JBX1CTMS09.....	P. 57
JBX1CTMS13.....	P. 57

Tooling

JBX1OUTLP07.....	P. 61
JBX1OUTLP09.....	P. 61
JBX1OUTLP13.....	P. 61
JBX1OUTLS07.....	P. 61
JBX1OUTLS09.....	P. 61
JBX1OUTLS13.....	P. 61
JBXOUTDCS07.....	P. 61
JBXOUTDC09.....	P. 61
JBXOUTDC13.....	P. 61
M22520/7-01.....	P. 61

Notes

A large grid of graph paper for taking notes, consisting of 20 columns and 30 rows of small squares.

Reliable People, Reliable Solutions



Your local contact



Our contribution to environmental protection:
This catalog is printed on PEFC certified paper
Advancement of sustainable wood cultivation. www.pefc.org

www.esterline-connection-technologies.com
technical-emear-ect@esterline.com (Europe - Asia - Africa)
technical-americas-ect@esterline.com (North America)

