

**1W** NATURAL CONVECTION

DC-DC POWER SUPPLIES

The single output IES01 series is an ideal solution for isolating voltage rails in a distributed power supply architecture such as analog, digital, data and relay circuits. This product family offers a compact design with high efficiency, 1.5kV isolation with 3.0kV optional, short circuit protection and high operating temperature.



## Features

- Unregulated single output
- $\pm 10\%$  input range
- Single outputs 3.3 to 24VDC
- SMD8 DIP package
- Industry standard pinout
- 1.5kVDC isolation, 3kVDC option
- UL62368-1 safety approvals
- Continuous short circuit protection
- Tape & reel option
- Operating temperature  $-40^{\circ}\text{C}$  to  $+105^{\circ}\text{C}$
- Full load to  $100^{\circ}\text{C}$
- 3 year warranty

## Applications



Industrial Electronics



Instrumentation



Technology

## Dimensions

0.52" x 0.335" x 0.285" (13.2 x 8.5 x 7.25 mm)

## Models & Ratings

Model Number <sup>(5,6)</sup>	Input Voltage	Output Voltage	Input Current <sup>(1)</sup>		Output Current		Maximum Capacitive Load	Efficiency <sup>(2)</sup>
			No Load	Full Load	Minimum	Maximum		
IES0105S03	5V (4.5-5.5V)	3.3V	5mA	270mA	30mA	303mA	2400 $\mu\text{F}$	74%
IES0105S05		5V	5mA	270mA	20mA	200mA	2400 $\mu\text{F}$	82%
IES0105S06 <sup>(3)</sup>		6V	5mA	270mA	17mA	167mA	2400 $\mu\text{F}$	82%
IES0105S09		9V	12mA	241mA	12mA	111mA	1000 $\mu\text{F}$	83%
IES0105S12		12V	12mA	241mA	9mA	84mA	560 $\mu\text{F}$	83%
IES0105S15		15V	18mA	241mA	7mA	67mA	560 $\mu\text{F}$	83%
IES0105S24		24V	18mA	241mA	4mA	42mA	220 $\mu\text{F}$	85%
IES0112S05	12V (10.8 - 13.2V)	5V	8mA	107mA	20mA	200mA	2400 $\mu\text{F}$	82%
IES0112S09		9V	8mA	106mA	12mA	111mA	1000 $\mu\text{F}$	83%
IES0112S12		12V	8mA	106mA	9mA	84mA	560 $\mu\text{F}$	83%
IES0112S15		15V	8mA	106mA	7mA	67mA	560 $\mu\text{F}$	83%
IES0112S24		24V	8mA	103mA	4mA	42mA	220 $\mu\text{F}$	85%
IES0115S05	15V (13.5-16.5V)	5V	8mA	86mA	20mA	200mA	2400 $\mu\text{F}$	82%
IES0115S15		15V	8mA	85mA	7mA	67mA	560 $\mu\text{F}$	83%
IES0124S05	24V (21.6 - 26.4V)	5V	8mA	55mA	20mA	200mA	2400 $\mu\text{F}$	82%
IES0124S09		9V	8mA	55mA	12mA	111mA	1000 $\mu\text{F}$	83%
IES0124S12		12V	8mA	55mA	9mA	84mA	560 $\mu\text{F}$	83%
IES0124S15		15V	8mA	55mA	7mA	67mA	560 $\mu\text{F}$	83%
IES0124S24		24V	8mA	53mA	4mA	42mA	220 $\mu\text{F}$	85%

### Notes:

1. Typical input currents measured at nominal input voltage.
2. Typical value at full load.
3. 6V model 1.5kV isolation only. Designed to meet UL62368-1.

4. Standard tube quantity = 38.
5. For tape & reel option add suffix -TR. Reel quantity = 500.
6. Optional 3kVDC isolation add suffix '-H'.

## Input

Characteristic	Minimum	Typical	Maximum	Units	Notes & Conditions
Input Voltage	4.5		26.4	VDC	See models and ratings table
Input Reflected Ripple		15/30	63	mA pk-pk	Through 4.7μH inductor and 220μF capacitor, 5V input/other models
Input Surge			9	VDC	IES0105 for max 1s
			18		IES0112 for max 1s
			21		IES0115 for max 1s
			30		IES0124 for max 1s
Input Current	See models and ratings table				
Input Filter	Capacitor				

## Output

Characteristic	Minimum	Typical	Maximum	Units	Notes & Conditions
Output Voltage	3.3		24	VDC	See models and ratings table
Initial Set Accuracy	See Load Regulation curves				
Minimum Load	10			%	
Line Regulation			±1.2	%	Per ±1% change of input voltage
Load Regulation	See Load Regulation curves				
Ripple and Noise		30 (50)	75 (100)	mV pk-pk	For models ≤15V/24V output, 20 MHz bandwidth, measured using 0.1μF capacitor
Short Circuit Protection	Continuous, with auto recovery				
Maximum Capacitive Load	See Models and Ratings table				
Temperature Coefficient			±0.02	%/°C	

## General

Characteristic	Minimum	Typical	Maximum	Units	Notes & Conditions
Efficiency	See Models and Ratings table				
Isolation: Input to Output	1500/3000			VDC	IES/IES-H functional
Switching Frequency	260	270	278	kHz	Low input voltage 10% load to high input voltage at full load
Isolation Resistance	10 <sup>9</sup>			Ω	Input to output, tested at 500VDC
Isolation Capacitance		20		pF	Input to output
Power Density			20.8	W/in <sup>3</sup>	
Mean Time Between Failure	3500			khrs	MIL-HDBK-217F, 25°C GB.
Weight		0.003 (1.4)		lb(g)	
Recommended Solder Profile	IPC/JEDEC J-STD-020D.1, peak temp ≤245°C, max duration, ≤60s at 217°C				
MSL	Level 1				
Case Material	Black plastic, flame retardant UL94V-0				
Pin Material	Phosphor bronze, solder coated				
Water Wash	Non-soaking water wash with de-ionised water. Dry thoroughly.				

## Mechanical Details

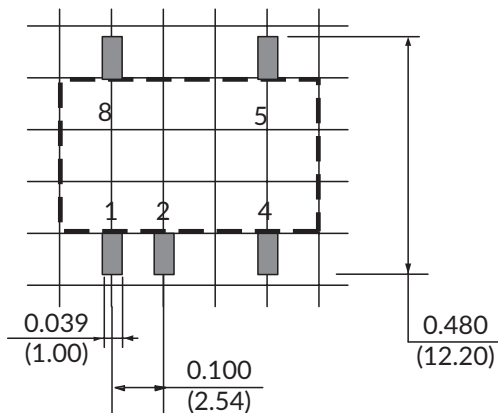
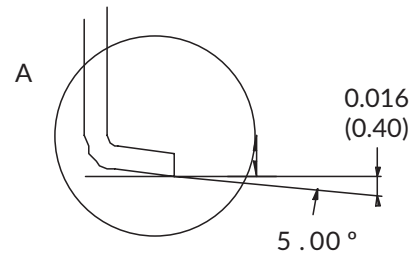
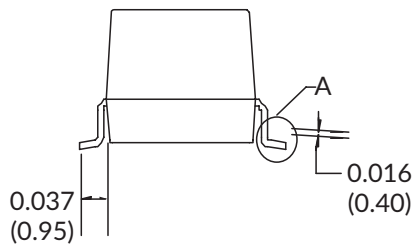
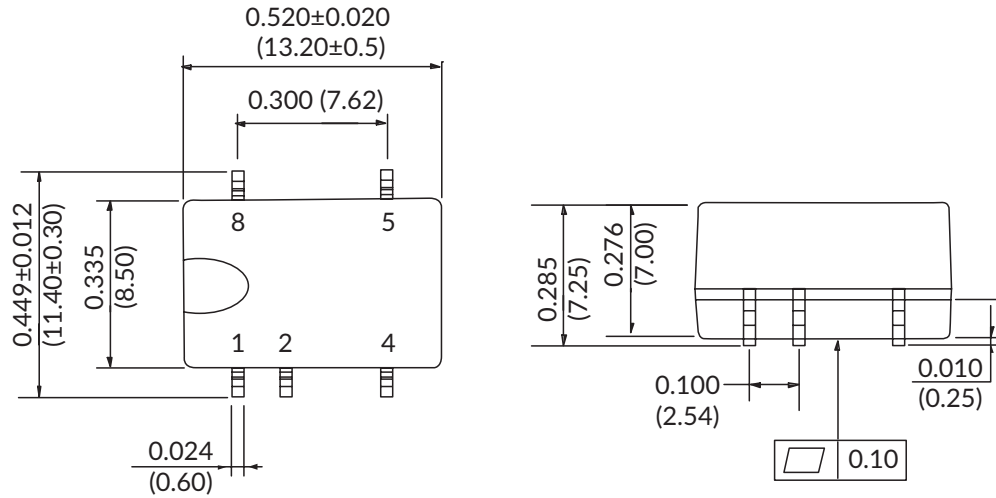

Pin Connections	
Pin	Function
1	-Vin
2	+Vin
4	-Vout
5	+Vout
8	No Connection <sup>(5)</sup>

Recommended Footprint  
 Top View grid: 0.1 x 0.1 in (2.54 x 2.54 mm)

### Notes:

- All dimensions are in inches (mm).
- Weight: 0.003lbs (1.4g) typical.
- Pin pitch and length tolerance:  $\pm 0.004$  ( $\pm 0.10$ ).
- Case tolerance:  $\pm 0.02$  ( $\pm 0.5$ ).
- Pin 8 leave floating.

## Environmental

Characteristic	Minimum	Typical	Maximum	Units	Notes & Conditions
Operating Temperature	-40		+105	°C	Derate from 100% load at +100°C to 80% load at 105°C
Storage Temperature	-55		+125	°C	
Case Temperature			+105	°C	
Case Temperature Rise		25/15		%RH	Ambient 25°C , 3V3 output/others
Operating Humidity			95	m	Non-condensing
Cooling	Natural convection				

## Safety Approvals

Safety Agency	Standard	Notes & Conditions
UL	UL62368-1	
CE	Meets all applicable directives	
UKCA	Meets all applicable legislation	

## EMC: Emissions

Phenomenon	Standard	Test Level	Notes & Conditions
Conducted	EN55032	Class B	See Application Note for Class B filter
Radiated	EN55032	Class B	

## EMC: Immunity

Phenomenon	Standard	Test Level	Criteria	Notes & Conditions
ESD Immunity	EN61000-4-2	±4kV contact / ±8kV air discharge	B	

## Load Regulation

5V input series

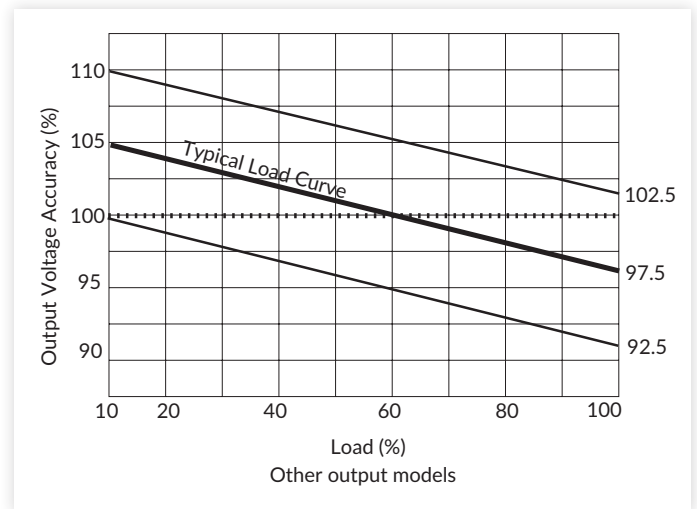
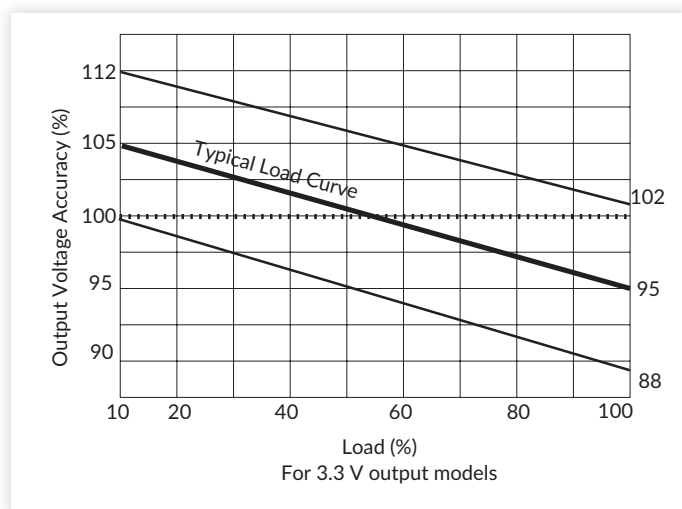

## Application Notes

### Other Input Series

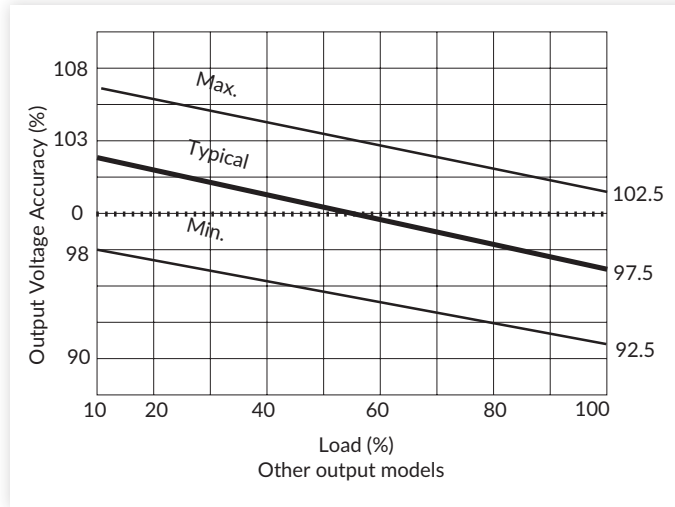

### EMI Filter for Class B Emissions

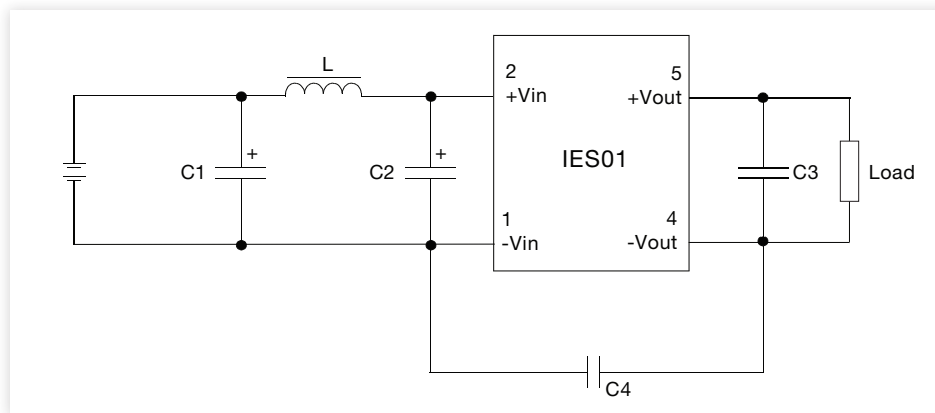

5V Input:				
Output Voltage	C1, C2	C3	C4	L
3.3V	4.7μF, 25V	10μF, 16V	Not fitted	6.8μH
5V		10μF, 16V		
9V		2.2μF, 25V		
12V		2.2μF, 25V	1nF	
15V		1μF, 25V		
24V		0.47μF, 50V		

C4: 2kV, ceramic. Upgrade C4 to 4kV for 3kV isolation option -H.

Other Input Series:				
Output Voltage	C1, C2	C3	C4	L
5V	4.7μF, 50V	10μF, 16V	270pF	6.8μH
9V		2.2μF, 16V		
12V		2.2μF, 25V		
15V		1μF, 25V		
24V		1μF, 50V		

C4: 2kV, ceramic. Upgrade C4 to 4kV for 3kV isolation option -H.

Application Notes

Temperature Derating Curve

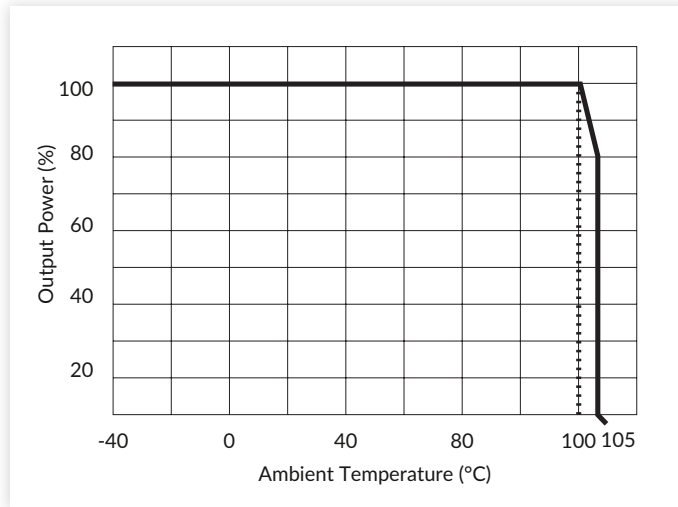

Efficiency vs Input Voltage (IES0105S05)

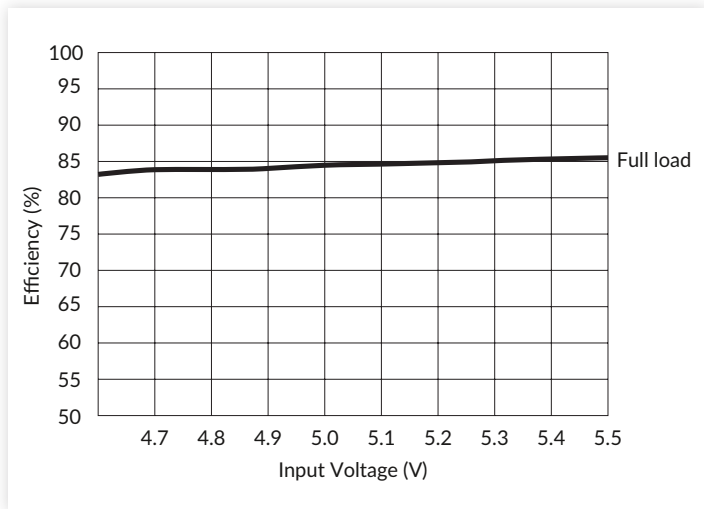

Efficiency vs Output Load (IES0105S05)

