



CENTURY SERIES INDUSTRIAL CONTROL TRANSFORMERS

*Engineered solutions for
power and the environment*



As we celebrate our 100th Anniversary,

the Dongan Team wishes to thank you for your past, present and future business participation. We look forward to providing your transformer requirements well into our next century.

Dongan is pleased to showcase our new Century Series Encapsulated Industrial Control Transformer System. Series IC Transformers are encapsulated in electrical grade epoxy to help seal out the harmful effects of moisture and airborne contaminants while providing excellent thermal transfer properties for longevity.

The IC Transformer System provides a platform from which multiple fusing, mounting and finger safe capabilities can be configured.



Table of Contents

Introduction	Page	2
Warranty	Page	2
Series IC	Page	3-9
Series ES	Page	10-11
Series HC	Page	12-15
Series 50	Page	16-20
Transformer Sizing	Page	21-22
Overcurrent Protection	Page	23



Warranty

Dongan Electric Manufacturing Company (Dongan), at Dongan's option, warrants to the original purchaser to correct by repair, refund of the original purchase price, or replacement, products that fail within the warranty period cited below.

Standard Catalog Transformers	10 Years
Custom Transformers	2 Years

Said warranty applies from the date of manufacture, provided the product has been installed, operated and maintained in accordance with all accepted industry practices and standards, that conditions of operation have been normal at all times, and that the product has not been subjected to any undue stress from excess voltage, frequency, load, or insufficient or inadequate ventilation.

Prompt written notice of any defect must be submitted to Dongan within the warranty period as provided above. The warranty applies on condition that Dongan's examination determines that the warranty claim is valid as submitted by the original purchaser.

Dongan's obligation under this warranty is in lieu of all other warranties expressed or implied including any warranties of merchantability and fitness for purpose and is limited to a refund of the original purchase price, replacement, or repair of the defective product.

Dongan will not be liable for any incidental, consequential, contingent or special damages, including loss of use, function or profits arising out of or in connection with the use of Dongan's products, and shall have no other liability for payment of any other damages. The remedy provided herein is Dongan's entire liability and the purchaser's sole remedy.

IC - Century Series Industrial Control Transformers

Features



- ◆ Voltage and fuse combinations suitable for global applications
- Epoxy encapsulated copper windings
- UL Class 105°C insulation system
- Cool operation with 55°C temperature rise
- All designs rated 50 / 60 Hertz
- DIN Rail mounting options 50 - 100 VA
- Combination screw heads for ease of installation
- IP 20 when finger safe terminal and/or fuse cover options are installed
- Meets or exceeds UL 5085, NEMA ST-1 and ANSI standards
- Jumper links provided

IC Series Voltage Combinations

Suffix	Primary	Secondary
-102	120 x 240	24
-103	240 x 480	120, Triple Rated
-107	240 x 480	120/240, Triple Rated
-109	380/400/415	110/220
-122	120 x 240	24, w/Dual Primary Fuse Holders
-123	240 x 480	120 Triple Rated, w/Dual Primary Fuse Holders
-127	240 x 480	120/240, Triple Rated, w/Dual Primary Fuse Holders
-129	380/400/415	110/220, w/Dual Primary Fuse Holders
-132	120 x 240	24, w/Three Primary Fuse Holders
-133	240 x 480	120, Triple Rated, w/Three Primary Fuse Holders
-137	240 x 480	120/240, Triple Rated, w/Three Primary Fuse Holder
-139	380/400/415	110/220, w/Three Primary Fuse Holders

Consult the factory or your Dongan Sales Representative for desired voltage combinations other than shown.



Suffix -102

Primary 120 x 240 - Secondary 24									Primary Max Amps 120/240 V	Secondary Max Amps 24 V
VA Rating	Catalog Number	Weight lbs	Dimensions (Inches/mm)			Mounting Dimensions (Inches/mm)				
			Height A	Width B	Depth C	W1	W2	D		
50	IC-0050-102	2.7	2.63/67	3.00/76	3.94/100	2.10/53.3	2.50/63.5	2.00/51	.42/.21	2.08
75	IC-0075-102	3.7	2.63/67	3.00/76	4.44/113	2.10/53.3	2.50/63.5	2.50/64	.63/.31	3.13
100	IC-0100-102	4.2	2.94/75	3.38/86	4.19/106	2.44/62	2.813/71.5	2.38/60	.83/.42	4.17
150	IC-0150-102	6.8	3.25/83	3.75/95	4.63/117	2.75/70	3.13/79	2.75/70	1.25/.63	6.25
250	IC-0250-102	9.2	3.88/98	4.50/114	4.44/113	3.56/90	3.94/100	2.75/70	2.08/1.04	10.42
350	IC-0350-102	12.5	3.88/98	4.50/114	5.44/138	3.56/90	3.94/100	3.75/95	2.92/1.46	14.58
500	IC-0500-102	18.2	4.50/114	5.25/133	5.44/138	4.00/101	4.38/111	3.63/92	4.17/2.08	20.83
750	IC-0750-102	22.2	5.00/127	5.25/133	6.94/176	4.00/101	4.38/111	5.25/133	6.25/3.13	31.25
1000	IC-1000-102	28.4	5.00/127	5.25/133	6.94/176	4.00/101	4.38/111	5.25/133	8.33/4.17	41.67

Suffix -103

Primary 240 x 480, 230 x 460, 220 x 440 - Secondary 120, 115, 110, Triple Rated									Primary Max Amps 240/480 V	Secondary Max Amps 120 V
VA Rating	Catalog Number	Weight lbs	Dimensions (Inches/mm)			Mounting Dimensions (Inches/mm)				
			Height A	Width B	Depth C	W1	W2	D		
50	IC-0050-103	2.7	2.63/67	3.00/76	3.94/100	2.10/53.3	2.50/63.5	2.00/51	.21/.10	.41
75	IC-0075-103	3.7	2.63/67	3.00/76	4.44/113	2.10/53.3	2.50/63.5	2.50/64	.31/.16	.62
100	IC-0100-103	4.2	2.94/75	3.38/86	4.19/106	2.44/62	2.813/71.5	2.38/60	.42/.21	.83
150	IC-0150-103	6.8	3.25/83	3.75/95	4.63/117	2.75/70	3.13/79	2.75/70	.63/.31	1.25
250	IC-0250-103	9.2	3.88/98	4.50/114	4.44/113	3.56/90	3.94/100	2.75/70	1.04/.52	2.08
350	IC-0350-103	12.5	3.88/98	4.50/114	5.44/138	3.56/90	3.94/100	3.75/95	1.46/.73	2.91
500	IC-0500-103	18.2	4.50/114	5.25/133	5.44/138	4.00/101	4.38/111	3.63/92	2.08/1.04	4.16
750	IC-0750-103	22.2	5.00/127	5.25/133	6.94/176	4.00/101	4.38/111	5.25/133	3.13/1.56	6.25
1000	IC-1000-103	28.4	5.00/127	5.25/133	6.94/176	4.00/101	4.38/111	5.25/133	4.17/2.08	8.33
1500	IC-1500-103	32	6.75/171	7.50/190	6.25/159	4.25/108	5.31/135	4.50/114	6.25/3.125	12.5
2000	IC-2000-103	38	6.75/172	7.50/191	7.25/184	4.25/109	5.31/135	5.50/140	8.3/4.16	16.7
3000	IC-3000-103	50	6.75/173	7.50/192	8.25/210	4.25/110	5.31/135	6.50/165	12.5/6.25	25

Suffix -107

Primary 240 x 480, 230 x 460, 220 x 440 - Secondary 120/240, 115/230, 110/220 Triple Rated									Primary Max Amps	Secondary Max Amps
VA Rating	Catalog Number	Weight lbs	Dimensions (Inches/mm)			Mounting Dimensions (Inches/mm)			240/480 V	120/240 V
			Height A	Width B	Depth C	W1	W2	D		
50	IC-0050-107	2.7	2.63/67	3.00/76	3.94/100	2.10/53.3	2.50/63.5	2.00/51	.21/.10	.41/.21
75	IC-0075-107	3.7	2.63/67	3.00/76	4.44/113	2.10/53.3	2.50/63.5	2.50/64	.31/.16	.63/.31
100	IC-0100-107	4.2	2.94/75	3.38/86	4.19/106	2.44/62	2.813/71.5	2.38/60	.42/.21	.83/.42
150	IC-0150-107	6.8	3.25/83	3.75/95	4.63/117	2.75/70	3.13/79	2.75/70	.63/.31	1.25/.63
250	IC-0250-107	9.2	3.88/98	4.50/114	4.44/113	3.56/90	3.94/100	2.75/70	1.04/.52	2.08/1.04
350	IC-0350-107	12.5	3.88/98	4.50/114	5.44/138	3.56/90	3.94/100	3.75/95	1.46/.73	2.92/1.46
500	IC-0500-107	18.2	4.50/114	5.25/133	5.44/138	4.00/101	4.38/111	3.63/92	2.08/1.04	4.17/2.08
750	IC-0750-107	22.2	5.00/127	5.25/133	6.94/176	4.00/101	4.38/111	5.25/133	3.13/1.56	6.25/3.13
1000	IC-1000-107	28.4	5.00/127	5.25/133	6.94/176	4.00/101	4.38/111	5.25/133	4.17/2.08	8.33/4.17
1500	IC-1500-107	32	6.75/171	7.50/190	6.25/159	4.25/108	5.31/135	4.50/114	6.25/3.125	12.5/6.25
2000	IC-2000-107	38	6.75/172	7.50/191	7.25/184	4.25/109	5.31/135	5.50/140	8.3/4.16	16.7/8.3
3000	IC-3000-107	50	6.75/173	7.50/192	8.25/210	4.25/110	5.31/135	6.50/165	12.5/6.25	25/12.5

Dimensions and weights may change. Consult factory for Certified Drawings.

Suffix -109

Primary 380/400/415 - Secondary 110/220									Primary Max Amps	Secondary Max Amps
VA Rating	Catalog Number	Weight lbs	Dimensions (Inches/mm)			Mounting Dimensions (Inches/mm)			380/400/415 V	110/220 V
			Height A	Width B	Depth C	W1	W2	D		
50	IC-0050-109	2.7	2.63/67	3.00/76	3.94/100	2.10/53.3	2.50/63.5	2.00/51	.13/.13/.12	.45/.23
75	IC-0075-109	3.7	2.63/67	3.00/76	4.44/113	2.10/53.3	2.50/63.5	2.50/64	.20/.19/.18	.68/.34
100	IC-0100-109	4.2	2.94/75	3.38/86	4.19/106	2.44/62	2.813/71.5	2.38/60	.26/.25/.24	.91/.45
150	IC-0150-109	6.8	3.25/83	3.75/95	4.63/117	2.75/70	3.13/79	2.75/70	.39/.38/.36	1.36/.68
250	IC-0250-109	9.2	3.88/98	4.50/114	4.44/113	3.56/90	3.94/100	2.75/70	.66/.63/.60	2.27/1.14
350	IC-0350-109	12.5	3.88/98	4.50/114	5.44/138	3.56/90	3.94/100	3.75/95	.92/.88/.84	3.18/1.59
500	IC-0500-109	18.2	4.50/114	5.25/133	5.44/138	4.00/101	4.38/111	3.63/92	1.32/1.25/1.20	4.55/2.27
750	IC-0750-109	22.2	5.00/127	5.25/133	6.94/176	4.00/101	4.38/111	5.25/133	1.97/1.88/1.81	6.82/3.41
1000	IC-1000-109	28.4	5.00/127	5.25/133	6.94/176	4.00/101	4.38/111	5.25/133	2.63/2.50/2.41	9.09/4.55
1500	IC-1500-109	32	6.75/171	7.50/190	6.25/159	4.25/108	5.31/135	4.50/114	3.95/3.75/3.61	13.6/6.81
2000	IC-2000-109	38	6.75/172	7.50/191	7.25/184	4.25/109	5.31/135	5.50/140	5.26/5/4.81	18.1/9.09
3000	IC-3000-109	50	6.75/173	7.50/192	8.25/210	4.25/110	5.31/135	6.50/165	7.89/7.50/7.22	27.3/13.6

Suffix -122

Primary 120 x 240 - Secondary 24 Featuring Factory Installed Dual Primary Fuse Holders									Primary Max Amps	Secondary Max Amps
VA Rating	Catalog Number	Weight lbs	Dimensions (Inches/mm)			Mounting Dimensions (Inches/mm)				
			Height A	Width B	Depth C	W1	W2	D	120/240 V	24 V
50	IC-0050-122	2.7	4.88/124	3.00/76	3.94/100	2.10/53.3	2.50/63.5	2.00/51	.42/.21	2.08
75	IC-0075-122	3.7	4.88/124	3.00/76	4.44/113	2.10/53.3	2.50/63.5	2.50/64	.63/.31	3.13
100	IC-0100-122	4.2	5.19/132	3.38/86	4.19/106	2.44/62	2.813/71.5	2.38/60	.83/.42	4.17
150	IC-0150-122	6.8	5.50/140	3.75/95	4.63/117	2.75/70	3.13/79	2.75/70	1.25/.63	6.25
250	IC-0250-122	9.2	6.13/156	4.50/114	4.44/113	3.56/90	3.94/100	2.75/70	2.08/1.04	10.42
350	IC-0350-122	12.5	6.13/156	4.50/114	5.44/138	3.56/90	3.94/100	3.75/95	2.92/1.46	14.58
500	IC-0500-122	18.2	6.75/171	5.25/133	5.44/138	4.00/101	4.38/111	3.63/92	4.17/2.08	20.83
750	IC-0750-122	22.2	6.75/171	5.25/133	6.94/176	4.00/101	4.38/111	5.25/133	6.25/3.13	31.25
1000	IC-1000-122	28.4	6.75/171	5.25/133	6.94/176	4.00/101	4.38/111	5.25/133	8.33/4.17	41.67

*Factory installed three pole fuse holders are available by ordering suffix -132. Note: The two primary fuse positions are rejection style (Class CC). Fuses are sold separately.

Suffix -123

Primary 240 x 480, 230 x 460, 220 x 440 - Secondary 120, 115, 110, Triple Rated Featuring Factory Installed Dual Primary Fuse Holders									Primary Max Amps	Secondary Max Amps
VA Rating	Catalog Number	Weight lbs	Dimensions (Inches/mm)			Mounting Dimensions (Inches/mm)				
			Height A	Width B	Depth C	W1	W2	D	240/480 V	120 V
50	IC-0050-123	2.7	4.88/124	3.00/76	3.94/100	2.10/53.3	2.50/63.5	2.00/51	.21/.10	.41
75	IC-0075-123	3.7	4.88/124	3.00/76	4.44/113	2.10/53.3	2.50/63.5	2.50/64	.31/.16	.62
100	IC-0100-123	4.2	5.19/132	3.38/86	4.19/106	2.44/62	2.813/71.5	2.38/60	.42/.21	.83
150	IC-0150-123	6.8	5.50/140	3.75/95	4.63/117	2.75/70	3.13/79	2.75/70	.63/.31	1.25
250	IC-0250-123	9.2	6.13/156	4.50/114	4.44/113	3.56/90	3.94/100	2.75/70	1.04/.52	2.08
350	IC-0350-123	12.5	6.13/156	4.50/114	5.44/138	3.56/90	3.94/100	3.75/95	1.46/.73	2.91
500	IC-0500-123	18.2	6.75/171	5.25/133	5.44/138	4.00/101	4.38/111	3.63/92	2.08/1.04	4.16
750	IC-0750-123	22.2	6.75/171	5.25/133	6.94/176	4.00/101	4.38/111	5.25/133	3.13/1.56	6.25
1000	IC-1000-123	28.4	6.75/171	5.25/133	6.94/176	4.00/101	4.38/111	5.25/133	4.17/2.08	8.33
1500	IC-1500-123	32	8.25/209.6	7.50/190	6.25/159	4.25/108	5.31/135	4.50/114	6.25/3.12	12.5
2000	IC-2000-123	38	8.25/209.6	7.50/191	7.25/184	4.25/109	5.31/136	5.50/140	8.33/4.16	16.66
3000	IC-3000-123	50	8.25/209.6	7.50/192	8.25/210	4.25/110	5.31/137	6.50/165	12.5/6.25	25

*Factory installed three pole fuse holders are available by ordering suffix -132. Note: The two primary fuse positions are rejection style (Class CC). Fuses are sold separately.

Dimensions and weights may change. Consult factory for Certified Drawings.

Suffix -127

Primary 240 x 480, 230 x 460, 220 x 440 - Secondary 120/240, 115/230, 110/220 Triple Rated Featuring Factory Installed Dual Primary Fuse Holders									Primary Max Amps	Secondary Max Amps
VA Rating	Catalog Number	Weight lbs	Dimensions (Inches/mm)			Mounting Dimensions (Inches/mm)				
			Height A	Width B	Depth C	W1	W2	D	240/480 V	120/240 V
50	IC-0050-127	2.7	4.88/124	3.00/76	3.94/100	2.10/53.3	2.50/63.5	2.00/51	.21/.10	.41/.21
75	IC-0075-127	3.7	4.88/124	3.00/76	4.44/113	2.10/53.3	2.50/63.5	2.50/64	.31/.16	.63/.31
100	IC-0100-127	4.2	5.19/132	3.38/86	4.19/106	2.44/62	2.813/71.5	2.38/60	.42/.21	.83/.42
150	IC-0150-127	6.8	5.50/140	3.75/95	4.63/117	2.75/70	3.13/79	2.75/70	.63/.31	1.25/.63
250	IC-0250-127	9.2	6.13/156	4.50/114	4.44/113	3.56/90	3.94/100	2.75/70	1.04/.52	2.08/1.04
350	IC-0350-127	12.5	6.13/156	4.50/114	5.44/138	3.56/90	3.94/100	3.75/95	1.46/.73	2.92/1.46
500	IC-0500-127	18.2	6.75/171	5.25/133	5.44/138	4.00/101	4.38/111	3.63/92	2.08/1.04	4.17/2.08
750	IC-0750-127	22.2	6.75/171	5.25/133	6.94/176	4.00/101	4.38/111	5.25/133	3.13/1.56	6.25/3.13
1000	IC-1000-127	28.4	6.75/171	5.25/133	6.94/176	4.00/101	4.38/111	5.25/133	4.17/2.08	8.33/4.17
1500	IC-1500-123	32	8.25/209.6	7.50/190	6.25/159	4.25/108	5.31/135	4.50/114	6.25/3.12	12.5/6.25
2000	IC-2000-123	38	8.25/209.7	7.50/191	7.25/184	4.25/109	5.31/136	5.50/140	8.33/4.16	16.66/8.33
3000	IC-3000-123	50	8.25/209.8	7.50/192	8.25/210	4.25/110	5.31/137	6.50/165	12.5/6.25	25/12.5

*Factory installed three pole fuse holders are available by ordering suffix -132. Note: The two primary fuse positions are rejection style (Class CC). Fuses are sold separately.

Suffix -129

Primary 380/400/415 - Secondary 110/220 Featuring Factory Installed Dual Primary Fuse Holders									Primary Max Amps	Secondary Max Amps
VA Rating	Catalog Number	Weight lbs	Dimensions (Inches/mm)			Mounting Dimensions (Inches/mm)				
			Height A	Width B	Depth C	W1	W2	D	380/400/415 V	110/220 V
50	IC-0050-129	2.7	4.88/124	3.00/76	3.94/100	2.10/53.3	2.50/63.5	2.00/51	.13/.13/.12	.45/.23
75	IC-0075-129	3.7	4.88/124	3.00/76	4.44/113	2.10/53.3	2.50/63.5	2.50/64	.20/.19/.18	.68/.34
100	IC-0100-129	4.2	5.19/132	3.38/86	4.19/106	2.44/62	2.813/71.5	2.38/60	.26/.25/.24	.91/.45
150	IC-0150-129	6.8	5.50/140	3.75/95	4.63/117	2.75/70	3.13/79	2.75/70	.39/.38/.36	1.36/.68
250	IC-0250-129	9.2	6.13/156	4.50/114	4.44/113	3.56/90	3.94/100	2.75/70	.66/.63/.60	2.27/1.14
350	IC-0350-129	12.5	6.13/156	4.50/114	5.44/138	3.56/90	3.94/100	3.75/95	.92/.88/.84	3.18/1.59
500	IC-0500-129	18.2	6.75/171	5.25/133	5.44/138	4.00/101	4.38/111	3.63/92	1.32/1.25/1.20	4.55/2.27
750	IC-0750-129	22.2	6.75/171	5.25/133	6.94/176	4.00/101	4.38/111	5.25/133	1.97/1.88/1.81	6.82/3.41
1000	IC-1000-129	28.4	6.75/171	5.25/133	6.94/176	4.00/101	4.38/111	5.25/133	2.63/2.50/2.41	9.09/4.55

*Factory installed three pole fuse holders are available by ordering suffix -132. Note: The two primary fuse positions are rejection style (Class CC). Fuses are sold separately.

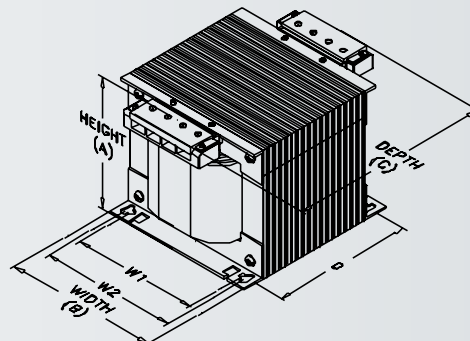

Dimensions and weights may change. Consult factory for Certified Drawings.

IC Century Series

Suffix -102 & -122				
Primary			Secondary	
Voltage	Jumper	Connect Incoming Lines To	Voltage	Connect Load To
120	H1 to H3 & H2 to H4	H1 & H4	24	X1 & X2
240	H2 to H3	H1 & H4		

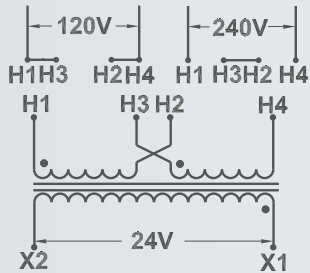

Suffix -103 & -123				
Primary			Secondary	
Voltage	Jumper	Connect Incoming Lines To	Voltage	Connect Load To
240 230 220	H1 to H3 & H2 to H4	H1 & H4	120 115 110	X1 & X2
480 460 440	H2 to H3	H1 & H4		

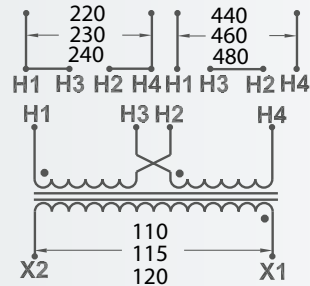

Suffix -109 & -129					
Primary			Secondary		
Voltage	Jumper	Connect Incoming Lines To	Voltage	Jumper	Connect Load To
380	-	H1 & H2	110	X1 to X3 & X2 to X4	X1 & X4
400	-	H1 & H3			
415	-	H1 & H4	220	X2 to X3	X1 & X4

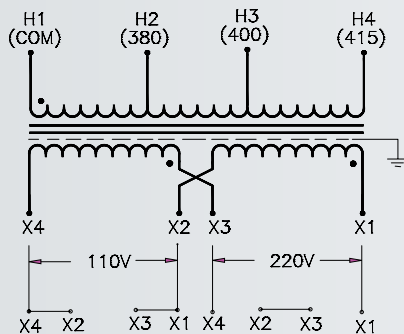

Suffix -107 & -127					
Primary			Secondary		
Voltage	Jumper	Connect Incoming Lines To	Voltage	Jumper	Connect Load To
240 230 220	H1 to H3 & H2 to H4	H1 & H4	120 115 110	X1 to X3 & X2 to X4	X1 & X4
480 460 440	H2 to H3	H1 & H4	120 115 110	X1 to X3 & X2 to X4	X1 & X4
240 230 220	H1 to H3 & H2 to H4	H1 & H4	240 230 220	X2 to X3	X1 & X4
480 460 440	H2 to H3	H1 & H4	240 230 220	X2 to X3	X1 & X4

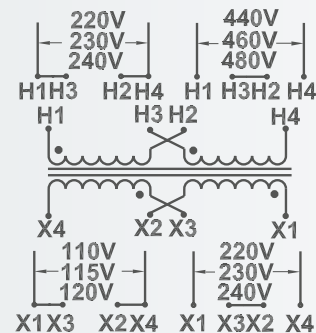

Series IC - Accessory Installation Instructions

Series IC Secondary Fuse Kit FCSEC 13/32" x 1 1/4" Fuses

	Max. Torque In-Lbs.	Wire Size Rating	Max. Fuse Rating
Terminal Screw	18	10 - 22 AWG	30 Amps @ 250 Volts

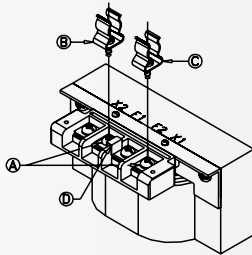

Fusing X1 Side of Secondary

- Remove the screws from F1 & X1
- Install Jumper Link (D) along with the 2 Fuse Clips (B & C) using a 10-32 Screw provided.
- Connect one side of Jumper Link to F1 and the other to F2. Insure the fuse clip end stops are facing away from each other.
- Tighten screws to rated torque from chart above. Do not overtighten.
- Connect the secondary load wires to F2 and X2.

Fusing X2 Side of Secondary

- Remove the screws from F2 & X2
- Install Jumper Link (D) along with the 2 Fuse Clips (B & C) using a 10-32 Screw provided.
- Connect one side of Jumper Link to F2 and the other to F1. Insure the fuse clip end stops are facing away from each other.
- Tighten screws to rated torque from chart above. Do not overtighten.
- Connect the secondary load wires to F1 and X1.

FCSEC Fuse Kit Contents

- 2 Fuse Clips
- 2 #10-32 Screws
- 1 Jumper Link
- 1 Instruction Sheet

Series IC Primary Fuse Kit FP2 Type CC Fuses

	Max. Torque In-Lbs.	Wire Size Rating	Max. Fuse Rating
Terminal Block	18	10 - 22 AWG	30 Amps @ 600 Volts
Fuse Block	20	10 - 22 AWG	

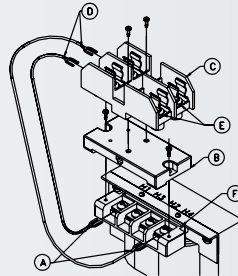

- Verify the primary jumpers are in the correct location for the desired input voltage.
- Connect one end of one of the Jumpers (A) to H1 and the other side to H4. (If using only fuse, connect one primary source wire to H4)
- Mount the Fuse Adapter Plate (B) to the Terminal Block using the 2 thread forming screws. The ridge on the bottom of the Fuse Adapter Plate must fit into the slot (F) of the Terminal Block.
- Mount the enclosed Fuse Block (C) to the Fuse Adapter Plate (B) using the 2 included machine screws.
- Connect the other side of the Jumpers (D) to the two Screw Terminals on the Fuse Block.
- Connect the primary source leads to the two Screw Terminals (E) on the Fuse Block.

FP2 Fuse Kit Contents

- 1 Fuse Adapter Plate
- 1 Two pole 13/32 x 1 1/2 Class CC, Rejection type Fuse Block
- 2 Machine Screws
- 2 Thread Forming Screws
- 2 Jumper w/Ring Terminals
- 1 Instruction Sheet

Series IC Primary Fuse Kit FP3 Type CC Fuses

	Max. Torque In-Lbs.	Wire Size Rating	Max. Fuse Rating
Terminal Block	18	10 - 22 AWG	30 Amps @ 600 Volts
Fuse Block	20	10 - 22 AWG	

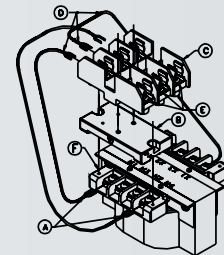

- Verify the primary jumpers are in the correct location for the desired input voltage.
- Connect one end of one of the Jumpers (A) to H1 and the other side to H4.
- Connect one side of the third lead wire to X1.
- Mount the Fuse Adapter Plate (B) to the Terminal Block using the 2 thread forming screws. The ridge on the bottom of the Fuse Adapter Plate must fit into the slot (F) of the Terminal Block.
- Mount the enclosed Fuse Block (C) to the Fuse Adapter Plate (B) using the 2 included machine screws.
- Connect the other side of the Jumpers (D) to the two Screw Terminals on the Fuse Block.
- Two will go to the primary fuse and one to the secondary fuse.
- Connect the primary source leads to the two Screw Terminals (E) on the Fuse Block.
- Connect one side of load to the secondary Fuse Block Terminal.

FP3 Fuse Kit Contents

- 1 Fuse Adapter Plate
- 1 Three pole 13/32 x 1 1/2 Class CC, Rejection type Fuse Block
- 2 Machine Screws
- 2 Thread Forming Screws
- 3 Jumper w/Ring Terminals
- 1 Instruction Sheet

Series IC - Accessory Installation Instructions

Series IC Secondary Fuse Kit FBSEC 1/4" x 1 1/4" Fuses			
	Max. Torque In-Lbs.	Wire Size Rating	Max. Fuse Rating
Terminal Block	18	10 - 22 AWG	30 Amps @ 300 Volts
Fuse Block	10	10 - 22 AWG	

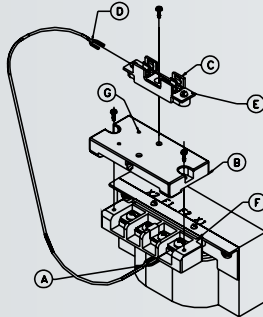

- Connect one side of the secondary load wire to X2
- Connect one secondary Jumper Wire (A) to X1
- Mount the Fuse Plate Adapter (B) to the terminal block using the 2 thread forming screws provided. The ridge on the bottom of the Fuse Plate Adapter Plate (B) must fit into the slot (F) of the Terminal Block.
- Mount the Fuse Block (C) to the Fuse Plate Adapter Plate (B) using one of the machine screws provided. Make sure the pin on the bottom of the Fuse Block is inserted into the hole (G) on the Fuse Plate Adapter (B).
- Connect the other side of the Jumper (D) to one side of the Fuse Block (C),
- Connect the other side of the secondary load wire to the open Fuse Block Terminal (E).

FBSEC Fuse Kit Contents

- 1 Fuse Adapter Plate
- 1 1/4 x 1 1/4 Fuse Block
- 1 Machine Screw
- 2 Thread Forming Screws
- 1 Jumper w/Ring Terminal
- 1 Instruction Sheet

Series IC Primary Fuse Kit FPS3 2-Type CC Fuses & 1-FNM Fuse			
	Max. Torque In-Lbs.	Wire Size Rating	Max. Fuse Rating
Terminal Block	18	10 - 22 AWG	30 Amps @ 250 Volts
Fuse Block	20	10 - 22 AWG	

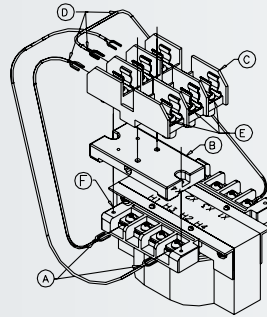

- Connect one side of the secondary load wire to X2
- Connect one secondary Jumper Wire (A) to X1
- Mount the Fuse Plate Adapter (B) to the terminal block using the 2 thread forming screws provided. The ridge on the bottom of the Fuse Plate Adapter Plate (B) must fit into the slot (F) of the Terminal Block.
- Mount the Fuse Block (C) to the Fuse Plate Adapter Plate (B) using one of the machine screws provided. Make sure the pin on the bottom of the Fuse Block is inserted into the hole (G) on the Fuse Plate Adapter (B).
- Connect the other side of the Jumper (D) to one side of the Fuse Block (C),
- Connect the other side of the secondary load wire to the open Fuse Block Terminal (E).

FPS3 Fuse Kit Contents

- 1 Fuse Adapter Plate
- 1 Three Pole Fuse Block 13/32 x 1 1/2 Class CC, 2 Poles Rejection, 1 Pole Standard
- 1 Machine Screw
- 2 Thread Forming Screws
- 3 Jumpers w/Ring Terminals
- 1 Instruction Sheet

Secondary Fuse Clips FCSEC

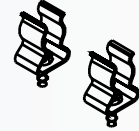

Secondary Fuse Cover FSC

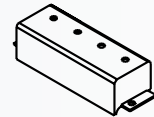

Low Terminal Cover TC-1

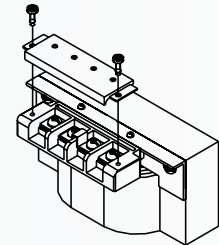

PFC Primary Class CC Fuse Cover - PFC

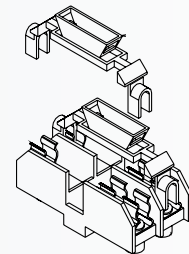

Fuse Adapter Plate FA

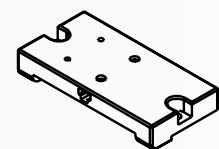

Features



- All Copper Windings
- IEC type finger safe terminals
- 200°C Insulation Systems
- 50/60 Hz
- Class 1, General Use, Isolating Transformer
- Electrostatic Shield, (earth metal screen)
- Regulation equals or exceeds industry standards
- Color coded protective earth (PE) terminal
- Nonstandard designs are available by consulting the factory or your Dongan Representative

ES Series Voltage Combinations		
Suffix	Primary	Secondary
.326	380/400/416/440/460/480/575	110/115/120
.366	380/416/480	120/24 (24 Volt load is limited to 20% of rated kVA maximum)
.376	380/400/416	110/220 115/230 120/240
.386	220/380/400/416	95/115/120

VA	Catalog Number	Catalog Number	Catalog Number	Catalog Number	Dimensions (Inches/mm)			Mounting Dimensions (Inches/mm)			Weight
					Height A	Width B	Depth C	D	E	F	
150	ES-10100.326	ES-10100.366	ES-10100.376	ES-10100.386	5.31/135	4.50/114	4.00/102	2.75/70	3.75/95	.203x.375 (5.2 x 9.5)	8
250	ES-10130.326	ES-10130.366	ES-10130.376	ES-10130.386	6.31/160	4.50/114	5.25/133	3.25/83	3.75/95	.312 x .625 (7.9 x 15.9)	10
375	ES-10150.326	ES-10150.366	ES-10150.376	ES-10150.386	6.31/160	4.50/114	6.00/152	4.50/114	3.75/95	.312 x .625 (7.9 x 15.9)	13
500	ES-10170.326	ES-10170.366	ES-10170.376	ES-10170.386	6.88/175	5.25/133	5.25/133	3.25/83	4.38/111	.312 x .625 (7.9 x 15.9)	15
750	ES-10190.326	ES-10190.366	ES-10190.376	ES-10190.386	7.81/198	6.38/162	6.00/152	4.00/102	5.31/135	.312 x .625 (7.9 x 15.9)	26
1000	ES-10200.326	ES-10200.366	ES-10200.376	ES-10200.386	7.81/198	6.38/162	6.50/165	4.50/114	5.31/135	.312 x .625 (7.9 x 15.9)	30
1500	ES-10210.326	ES-10210.366	ES-10210.376	ES-10210.386	8.81/224	7.50/191	6.00/152	4.00/102	6.00/152	.312 x .625 (7.9 x 15.9)	36
2000	ES-10230.326	ES-10230.366	ES-10230.376	ES-10230.386	8.81/224	7.50/191	7.00/178	5.00/127	6.00/152	.312 x .625 (7.9 x 15.9)	50
3000	ES-10250.326		ES-10250.376	ES-10250.386	8.88/226	7.50/191	8.00/203	6.00/152	6.00/152	.312 x .625 (7.9 x 15.9)	60
5000	ES-10300.326		ES-10300.376	ES-10300.386	10.31/262	9.00/229	9.00/229	6.50/165	6.50/165	.312 x .625 (7.9 x 15.9)	90

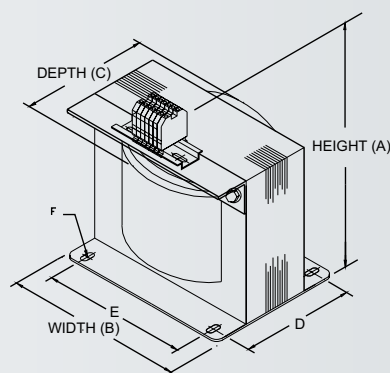

Series ES
Style of terminals may vary depending on availability.

A Certificate of Compliance is available by contacting your Dongan Representative or the factory Customer Service Department.

Dimensions and weights may change. Consult factory for Certified Drawings.

Suffix - .366			
Primary		Secondary	
Voltage	Connect Incoming Lines To	Secondary Voltage	Connect Load To
380	H1 & H3	24*	X1 & X3
416	H1 & H4	120	X1 & X4
480	H1 & H5		

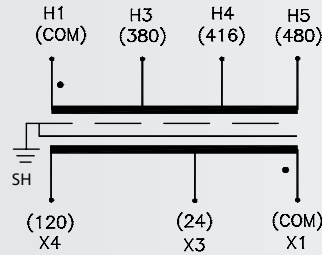

*Maximum permissible load on the 24 volt secondary is limited to 20% of the transformer's kVA. When 24 and 120 volts are used simultaneously, the total of both loads must not exceed the total transformer kVA.

Suffix - .326			
Primary		Secondary	
Voltage	Connect Incoming Lines To	Secondary Voltage	Connect Load To
380	H1 & H3	110	X1 & X3
400	H1 & H3	115	X1 & X3
416	H1 & H4	115	X1 & X4
440	H1 & H4	120	X1 & X4
460	H1 & H4	115	X1 & X3
480	H1 & H4	120	X1 & X3
575	H1 & H5	120	X1 & X4

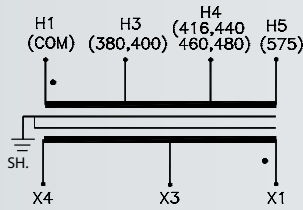

Suffix - .376				
Primary		Secondary		
Voltage	Connect Incoming Lines To	Secondary Voltage	Interconnect	Connect Load To
380	H1 & H2	110	X1 to X3	X1 & X4
400	H1 & H2	115	& X2 to X4	X1 & X4
416	H1 & H2	120	X2 to X4	X1 & X4
380	H1 & H2	220		X1 & X4
400	H1 & H2	230	X2 to X3	X1 & X4
416	H1 & H2	240		X1 & X4
416	H1 & H2	120/240	X2 to X3	X1 & X2/X3 & X4

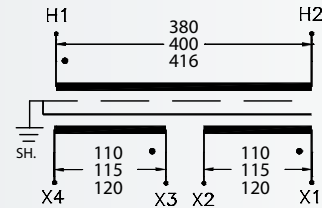

Suffix - .386			
Primary		Secondary	
Voltage	Connect Incoming Lines To	Secondary Voltage	Connect Load To
220	H1 & H3	95	X1 & X3
380	H1 & H4	115	X1 & X4
400	H1 & H5	120	X1 & X5
416	H1 & H6		

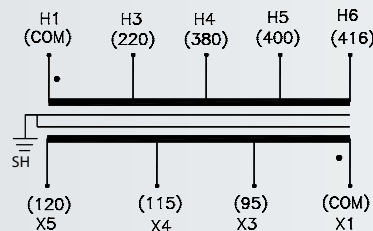

Features



- All Copper Windings
- Core mounted, barrier type terminal panels
- Series/parallel jumper clips provided
- Secondary fuse kits (FKS) furnished
- Easy installation of available primary fuse kit (FK2P)
- Regulation equals or exceeds industry standards
- UL Class 180°C insulation system, 55°C temperature rise through 150 VA
- UL Class 180°C insulation system, 115°C temperature rise 250 VA and above
- All designs rated 50 / 60 Hertz up to 750 VA, 60 Hertz 1000 VA and above
- Primary fuse blocks and secondary fuse holders available
- Combination screw heads for ease of installation
- Meets or exceeds UL 506, NEMA ST-1 and ANSI standards
- Nonstandard designs are available by consulting the factory or your Dongan Representative

HC Series Voltage Combinations

Suffix	Primary	Secondary
-41	240 x 480	120 Triple Rated
-4100	240 x 480	120 Triple Rated w/ Fuse Blocks Installed
-44	208/240/480	120
-4400	208/240/480	120 w/ Fuse Blocks Installed
-46	600/575/550	120/115/110
-47	240/480/600	120/115/110

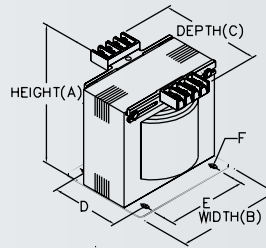

Outline Drawing
HC Suffix -41, -44, -46, -47

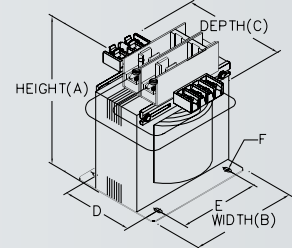

Outline Drawing
HC Suffix -4100, -4400

Suffix -41

VA	Catalog Number	Weight	Primary 240 x 480, 230 x 460, 220 x 440 - Secondary 120, 115, 110 - Triple Rated						Primary Max Amps	Secondary Max Amps
			Dimensions (Inches/mm)			Mounting Dimensions (Inches/mm)				
			Height A	Width B	Depth C	D	E	F	240/480 V	120 V
50	HC-0050-41	3	3.25/83	3.00/76	4.75/121	2.00/51	2.50/64	.203x.375 (5.2 x 9.5)	.21/.10	.42
75	HC-0075-41	4	3.25/83	3.00/76	5.25/133	2.50/64	2.50/64	.203x.375 (5.2 x 9.5)	.31/.16	.63
100	HC-0100-41	5	3.25/83	3.00/76	5.62/143	2.87/73	2.50/64	.203x.375 (5.2 x 9.5)	.42/.21	.83
150	HC-0150-41	7	3.75/95	3.75/95	5.25/133	2.62/67	3.13/80	.203x.375 (5.2 x 9.5)	.63/.31	1.25
250	HC-0250-41	8.5	3.75/95	3.75/95	5.62/143	2.87/73	3.13/80	.203x.375 (5.2 x 9.5)	1.04/.52	2.08
300	HC-0300-41	9.5	3.75/95	3.75/95	6.00/152	3.25/83	3.13/80	.203x.375 (5.2 x 9.5)	1.25/.63	2.50
375	HC-0375-41	10	4.25/108	4.50/114	5.50/140	2.75/70	3.75/95	.203x.375 (5.2 x 9.5)	1.56/.78	3.13
500	HC-0500-41	11.5	4.25/108	4.50/114	6.00/142	3.25/83	3.75/95	.203x.375 (5.2 x 9.5)	2.08/1.04	4.17
750	HC-0750-41	15.5	4.25/108	4.50/114	6.87/175	4.12/105	3.75/95	.203x.375 (5.2 x 9.5)	3.12/1.56	6.25
1000	HC-1000-41	19	4.87/124	5.25/133	6.50/165	3.87/98	4.37/111	.281x562 (7.1 x 14.3)	4.16/2.08	8.33
1500	HC-1500-41	27	4.87/124	5.25/133	7.87/200	5.12/130	4.37/111	.281x562 (7.1 x 14.3)	6.25/3.12	12.50
2000	HC-2000-41	32	4.87/124	5.25/133	9.12/232	6.40/163	4.37/111	.281x562 (7.1 x 14.3)	8.33/4.16	16.67

Suffix -44

VA	Catalog Number	Weight	Primary 208 / 240 / 480 - Secondary 120						Primary Max Amps	Secondary Max Amps
			Dimensions (Inches/mm)			Mounting Dimensions (Inches/mm)				
			Height A	Width B	Depth C	D	E	F	208/240/480 V	120 V
50	HC-0050-44	3	3.25/83	3.00/76	5.00/127	2.25/57	2.50/64	.203x.375 (5.2 x 9.5)	.24/.21/.10	.42
75	HC-0075-44	4	3.25/83	3.00/76	5.62/143	2.87/73	2.50/64	.203x.375 (5.2 x 9.5)	.36/.31/.16	.63
100	HC-0100-44	5.5	3.75/95	3.75/95	5.25/133	2.50/64	3.13/80	.203x.375 (5.2 x 9.5)	.48/.42/.21	.83
150	HC-0150-44	7.5	3.75/95	3.75/95	6.12/155	3.31/84	3.13/80	.203x.375 (5.2 x 9.5)	.72/.63/.31	1.25
250	HC-0250-44	8.5	4.30/1.09	4.50/114	5.25/133	2.50/64	3.75/95	.203x.375 (5.2 x 9.5)	1.21/1.04/.52	2.08
300	HC-0300-44	10.5	4.30/1.09	4.50/114	6.00/152	3.25/83	3.75/95	.203x.375 (5.2 x 9.5)	1.4/1.25/.63	2.50
375	HC-0375-44	11.5	4.30/1.09	4.50/114	6.00/152	3.25/83	3.75/95	.203x.375 (5.2 x 9.5)	1.8/1.56/.78	3.13
500	HC-0500-44	13.5	4.30/1.09	4.50/114	6.50/165	3.75/95	3.75/95	.203x.375 (5.2 x 9.5)	2.4/2.08/1.04	4.17
750	HC-0750-44	18.5	4.87/124	5.25/133	6.50/165	3.75/95	4.37/111	.203x.375 (5.2 x 9.5)	3.6/3.12/1.56	6.25
1000	HC-1000-44	20	4.87/124	5.25/133	6.75/171	4.00/102	4.37/111	.281x562 (7.1 x 14.3)	4.8/4.16/2.08	8.33
1500	HC-1500-44	29.5	4.87/124	5.25/133	8.50/216	5.87/149	4.37/111	.281x562 (7.1 x 14.3)	7.2/6.25/3.12	12.50
2000	HC-2000-44	32	6.25/159	4.25/108	8.50/216	5.93/151	3.43/87	.281x562 (7.1 x 14.3)	9.6/8.33/4.16	16.67

Dimensions and weights may change. Consult factory for Certified Drawings.

Suffix -46

Primary 600/575/550 - Secondary 120, 115, 110 - Triple Rated									Primary Max Amps	Secondary Max Amps
VA	Catalog Number	Weight lbs	Dimensions (Inches/mm)			Mounting Dimensions (Inches/mm)				
			Height A	Width B	Depth C	D	E	F	600 V	120 V
50	HC-0050-46	3	3.25/83	3.00/76	4.75/121	2.00/51	2.50/64	.203x.375 (5.2 x 9.5)	.08	.42
75	HC-0075-46	4	3.25/83	3.00/76	5.25/133	2.50/64	2.50/64	.203x.375 (5.2 x 9.5)	.13	.63
100	HC-0100-46	5	3.25/83	3.00/76	5.62/143	2.87/73	2.50/64	.203x.375 (5.2 x 9.5)	.17	.83
150	HC-0150-46	7	3.75/95	3.75/95	5.25/133	2.62/67	3.13/80	.203x.375 (5.2 x 9.5)	.25	1.25
250	HC-0250-46	8.5	3.75/95	3.75/95	5.62/143	2.87/73	3.13/80	.203x.375 (5.2 x 9.5)	.42	2.08
300	HC-0300-	9.5	3.75/95	3.75/95	6.00/142	3.25/83	3.13/80	.203x.375 (5.2 x 9.5)	.50	2.50
375	HC-0375-46	10	4.2/107	4.50/114	5.30/135	2.75/70	3.75/95	.203x.375 (5.2 x 9.5)	.63	3.13
500	HC-0500-46	11.5	4.25/108	4.50/114	6.00/142	3.25/83	3.75/95	.203x.375 (5.2 x 9.5)	.83	4.17
750	HC-0750-46	15.5	4.25/108	4.50/114	6.87/175	4.12/105	3.75/95	.203x.375 (5.2 x 9.5)	1.3	6.25
1000	HC-1000-46	19	4.87/124	5.25/133	6.50/165	3.87/98	4.37/111	.281x562 (7.1 x 14.3)	1.7	8.33
1500	HC-1500-46	27	4.87/124	5.25/133	7.87/200	5.12/130	4.37/111	.281x562 (7.1 x 14.3)	2.5	12.50
2000	HC-2000-46	32	4.87/124	5.25/133	9.12/232	6.40/163	4.37/111	.281x562 (7.1 x 14.3)	3.3	16.67

Suffix -47

Primary 240/480/600, 230/460/575, 220/440/550 - Secondary 120/115/110 Triple Rated									Primary Max Amps	Secondary Max Amps
VA	Catalog Number	Weight lbs	Dimensions (Inches/mm)			Mounting Dimensions (Inches/mm)				
			Height A	Width B	Depth C	D	E	F	208/240/480 V	120 V
50	HC-0050-47	3	3.25/83	3.00/76	5.00/127	2.25/57	2.50/64	.203x.375 (5.2 x 9.5)	.21/1.10/0.08	.42
75	HC-0075-47	4	3.25/83	3.00/76	5.62/143	2.87/73	2.50/64	.203x.375 (5.2 x 9.5)	.31/1.16/1.13	.63
100	HC-0100-47	5.5	3.75/95	3.75/95	5.25/133	2.50/64	3.13/80	.203x.375 (5.2 x 9.5)	.42/2.1/1.17	.83
150	HC-0150-47	7.5	3.75/95	3.75/95	6.12/155	3.31/84	3.13/80	.203x.375 (5.2 x 9.5)	.63/3.1/1.25	1.25
250	HC-0250-47	8.5	4.30/1.09	4.50/114	5.25/133	2.50/64	3.75/95	.203x.375 (5.2 x 9.5)	1.04/1.52/1.42	2.08
300	HC-0300-47	10.5	4.30/1.09	4.50/114	6.00/152	3.25/83	3.75/95	.203x.375 (5.2 x 9.5)	1.25/1.63/1.50	2.50
375	HC-0375-47	11.5	4.30/1.09	4.50/114	6.00/152	3.25/83	3.75/95	.203x.375 (5.2 x 9.5)	1.56/1.78/1.63	3.13
500	HC-0500-47	13.5	4.30/1.09	4.50/114	6.50/165	3.75/95	3.75/95	.203x.375 (5.2 x 9.5)	2.08/1.04/1.83	4.17
750	HC-0750-47	18.5	4.87/124	5.25/133	6.50/165	3.75/95	4.37/111	.203x.375 (5.2 x 9.5)	3.1/1.6/1.3	6.25
1000	HC-1000-47	20	4.87/124	5.25/133	6.75/171	4.00/102	4.37/111	.281x562 (7.1 x 14.3)	4.16/2.08/1.7	8.33
1500	HC-1500-47	29.5	4.87/124	5.25/133	8.50/216	5.87/149	4.37/111	.281x562 (7.1 x 14.3)	6.25/3.12/2.5	12.50
2000	HC-2000-47	32	6.25/159	4.25/108	8.50/216	5.93/151	3.43/87	.281x562 (7.1 x 14.3)	8.33/4.16/3.3	16.67

Features Pre-Connected Dual Primary Fuse Blocks

Suffix -4100

Primary 240 x 480, 230 x 460, 220 x 440 - Secondary 120, 115, 110 - Triple Rated									Primary Max Amps	Secondary Max Amps
VA	Catalog Number	Weight lbs	Dimensions (Inches/mm)			Mounting Dimensions (Inches/mm)				
			Height A	Width B	Depth C	D	E	F	240/480 V	120 V
50	HC-0050-4100	3	4.25/108	3.00/76	4.75/121	2.00/51	2.50/64	.203x.375 (5.2 x 9.5)	.21/1.10	.42
75	HC-0075-4100	4	4.25/108	3.00/76	5.25/133	2.50/64	2.50/64	.203x.375 (5.2 x 9.5)	.31/1.16	.63
100	HC-0100-4100	5	4.25/108	3.00/76	5.62/143	2.87/73	2.50/64	.203x.375 (5.2 x 9.5)	.42/2.1	.83
150	HC-0150-4100	7	4.75/121	3.75/95	5.25/133	2.62/67	3.13/80	.203x.375 (5.2 x 9.5)	.63/3.1	1.25
250	HC-0250-4100	8.5	4.75/121	3.75/95	5.62/143	2.87/73	3.13/80	.203x.375 (5.2 x 9.5)	1.04/1.52	2.08
300	HC-0300-4100	9.5	4.75/121	3.75/95	6.00/152	2.87/73	3.13/80	.203x.375 (5.2 x 9.5)	1.25/1.63	2.50
375	HC-0375-4100	10	5.30/135	4.50/114	5.50/140	2.75/70	3.75/95	.203x.375 (5.2 x 9.5)	1.56/1.78	3.13
500	HC-0500-4100	11.5	5.25/133	4.50/114	6.00/142	3.25/83	3.75/95	.203x.375 (5.2 x 9.5)	2.08/1.04	4.17
750	HC-0750-4100	15.5	5.25/133	4.50/114	6.87/175	4.12/105	3.75/95	.203x.375 (5.2 x 9.5)	3.12/1.56	6.25
1000	HC-1000-4100	19	5.87/149	5.25/133	6.50/165	3.87/98	4.37/111	.281x562 (7.1 x 14.3)	4.16/2.08	8.33
1500	HC-1500-4100	27	5.87/149	5.25/133	7.87/200	5.12/130	4.37/111	.281x562 (7.1 x 14.3)	6.25/3.12	12.50
2000	HC-2000-4100	32	5.87/149	5.25/133	9.12/232	6.40/163	4.37/111	.281x562 (7.1 x 14.3)	8.33/4.16	16.67

Dimensions and weights may change. Consult factory for Certified Drawings.



Suffix -4400

Features Pre-Connected Dual Primary Fuse Blocks

Primary 208 / 240 / 480 - Secondary 120									Primary Max Amps	Secondary Max Amps
VA	Catalog Number	Weight lbs	Dimensions (Inches/mm)			Mounting Dimensions (Inches/mm)				
			Height A	Width B	Depth C	D	E	F	208/240/480 V	120 V
50	HC-0050-4400	3	4.25/108	3.00/76	5.00/127	2.25/57	2.50/64	.203x.375 (5.2 x 9.5)	.24/.21/.10	.42
75	HC-0075-4400	4	4.25/108	3.00/76	5.62/143	2.87/73	2.50/64	.203x.375 (5.2 x 9.5)	.36/.31/.16	.63
100	HC-0100-4400	5.5	4.75/121	3.75/95	5.25/133	2.50/64	3.13/80	.203x.375 (5.2 x 9.5)	.48/.42/.21	.83
150	HC-0150-4400	7.5	4.75/121	3.75/95	6.12/155	3.31/84	3.13/80	.203x.375 (5.2 x 9.5)	.72/.63/.31	1.25
250	HC-0250-4400	8.5	5.50/140	4.50/114	5.25/133	2.50/64	3.75/95	.203x.375 (5.2 x 9.5)	1.21/1.04/.52	2.08
300	HC-0300-4400	10.5	5.50/140	4.50/114	6.00/152	3.25/83	3.75/95	.203x.375 (5.2 x 9.5)	1.41/1.25/.63	2.50
375	HC-0375-4400	11.5	5.50/140	4.50/114	6.00/152	3.25/83	3.75/95	.203x.375 (5.2 x 9.5)	1.8/1.56/.78	3.13
500	HC-0500-4400	13.5	5.50/140	4.50/114	6.50/165	3.75/95	3.75/95	.203x.375 (5.2 x 9.5)	2.4/2.08/1.04	4.17
750	HC-0750-4400	18.5	6.25/159	5.25/133	6.50/165	3.75/95	4.37/111	.203x.375 (5.2 x 9.5)	3.6/3.12/1.56	6.25
1000	HC-1000-4400	20	6.25/159	5.25/133	6.75/171	4.00/102	4.37/111	.281x562 (7.1 x 14.3)	4.8/4.16/2.08	8.33
1500	HC-1500-4400	29.5	6.25/159	5.25/133	8.50/216	5.87/149	4.37/111	.281x562 (7.1 x 14.3)	7.2/6.25/3.12	12.50
2000	HC-2000-4400	32	5.25/133	4.25/108	8.50/216	5.93/151	3.43/87	.281x562 (7.1 x 14.3)	9.6/8.33/4.16	16.67

Series HC Primary Fuse Kit Installation

Fuse Kit FKP2

- Meets UL 508
- Meets NEC Article 450
- Uses Class CC Fuses

Installation Procedure

- Locate the mounting hole in the terminal block of primary side of transformer.
- Fasten FKP2 Fuse Holder to primary side of transformer terminal block with the screw provided.
- Connect the Fuse Holder leads to the transformer terminals with the jumper leads furnished.

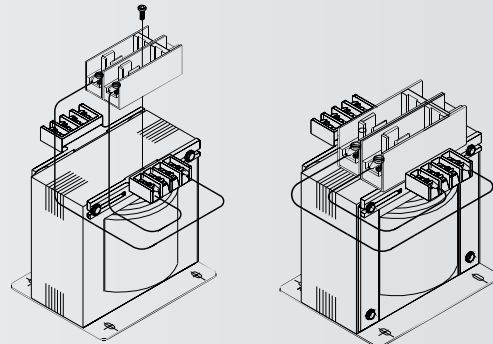

Series HC Recommended Fuse Type by Manufacturer

Manufacturer	Bussman	Gould	Littlefuse
Primary Fuse Type	FNQ-R	ATQR / ATDR	KLDR / CCRM
Secondary Fuse Type	FNM / FNQ (250V) (500V)	TRM / ATQ (250V) (500V)	FLM / FLQ (250V) (500V)

Note: Fuses sold separately.

Series HC Secondary Fuse Kit Installation

Fuse Kit FKS

- Meets UL 508
- Meets NEC Article 450
- Uses 13/32" x 1 1/2" Fuses

Installation Procedure

- To fuse Terminal X1, remove #10 screws in Terminals X1, XF, and unmarked terminal slot.
- Fasten Fuse Clip to transformer Terminal X1 using a #10 screw.
- Fasten a #10 screw through Fuse Clip and Jumper Terminal and into unmarked Terminal slot.
- Fasten #10 screw through Jumper Terminal and into Terminal XF.
- Connect load to terminals X2 and XF.

Secondary Fuse Kit FKS
Furnished with each Transformer

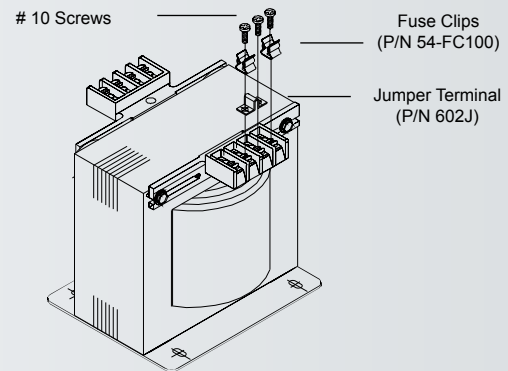

Note: Fuses sold separately.

Dimensions and weights may change. Consult factory for Certified Drawings.

Series HC are shipped with Jumper Clips connected in Series

Jumpers shown stacked for Series Connections

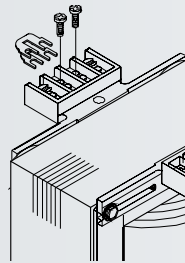

Jumpers shown spread for Parallel Connections

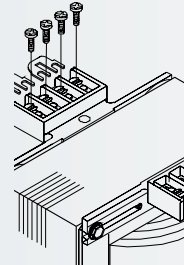

Suffix -41				
Primary		Connect Incoming Lines To	Secondary	
Voltage	Jumper		Voltage	Connect Load To
240	H1 to H3 & H2 to H4	H1 & H4	120	X1 & X2
230			115	
220			110	
480	H2 to H3	H1 & H4		
460				
440				

Suffix -44				
Primary		Connect Incoming Lines To	Secondary	
Voltage	Jumper		Voltage	Connect Load To
208	-	H1 & H2		
240	-	H1 & H3	120	X1 & X2
480	-	H1 & H4		

Suffix -46				
Primary		Connect Incoming Lines To	Secondary	
Voltage	Jumper		Voltage	Connect Load To
600	-	H1 & H2	120	X1 & X2

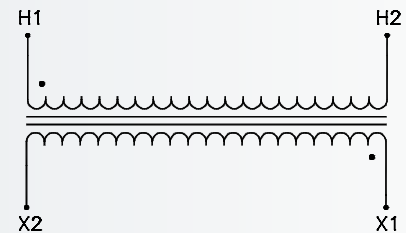
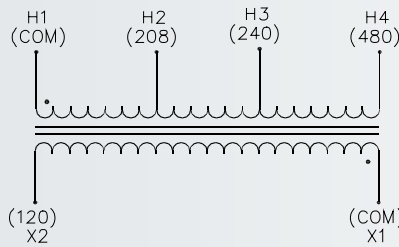
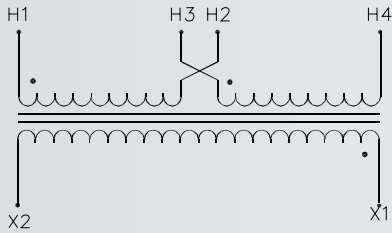

Suffix -47				
Primary		Connect Incoming Lines To	Secondary	
Voltage	Jumper		Voltage	Connect Load To
240	-	H1 & H2		
480	-	H1 & H3	120	X1 & X2
600	-	H1 & H4		

Suffix -4100				
Primary		Connect Incoming Lines To	Secondary	
Voltage	Jumper		Voltage	Connect Load To
240	H1 to H3 & H2 to H4	H1 & H4	120	XF & X2
230			115	
220			110	
480	H2 to H3	H1 & H4		
460				
440				

Suffix -4400				
Primary		Connect Incoming Lines To	Secondary	
Voltage	Jumper		Voltage	Connect Load To
208	-	H1 & H2		
240	-	H1 & H3	120	XF & X2
480	-	H1 & H4		

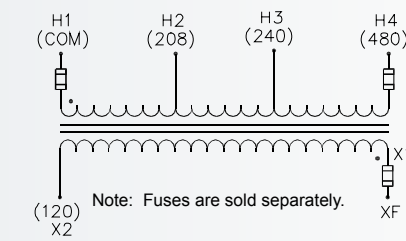
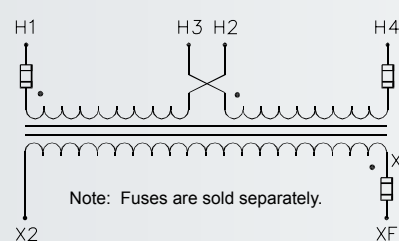
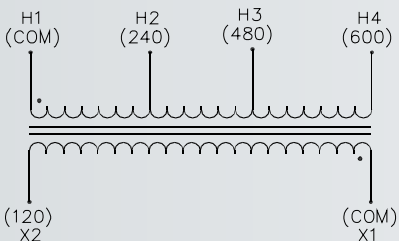

Features



- All Copper Windings
- Rugged coil mounted screw terminals
- UL Class 105°C insulation system, 55°C temperature rise through 750 VA
- UL Class 180°C insulation system, 115°C temperature rise 1000 VA and above
- All designs rated 50 / 60 Hertz
- Primary fuse blocks and secondary fuse holders available
- Combination screw heads for ease of installation
- Meets or exceeds UL 506, NEMA ST-1 and ANSI standards
- Nonstandard designs are available by consulting the factory or your Dongan Representative.

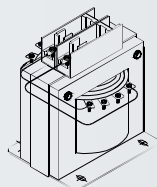
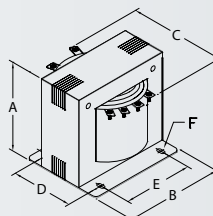

50 Series Voltage Combinations

Suffix	Primary	Secondary
-052	120 x 240	24
-053	240 x 480	120 Triple Rated
-054	208	120
-056	600	120
-058	220/380/415	95/115
-059	208 or 500	85/100/110
	220/380/440/550	91/110/120
	230/400/460/575	95/115/125
	240/416/480/600	99/120/130
-134	240 x 480	120 / 240 Triple Rated

Suffix -052

Primary 120 x 240 - Secondary 24									Primary Max Amps	Secondary Max Amps
VA	Catalog Number	Weight lbs	Dimensions (Inches/mm)			Mounting Dimensions (Inches/mm)			120/240 V	24 V
			Height A	Width B	Depth C	D	E	F		
50	50-0050-052	3	2.50/64	3.00/76	3.00/76	2.00/51	2.50/64	.203x.375 (5.2 x 9.5)	.42/21	2.08
75	50-0075-052	3	2.50/64	3.00/76	3.38/86	2.50/64	2.50/64	.203x.375 (5.2 x 9.5)	.63/.31	3.13
100	50-0100-052	4	2.81/71	3.38/86	3.38/86	2.38/60	2.81/71	.203x.375 (5.2 x 9.5)	.83/.42	4.17
150	50-0150-052	6	3.13/80	3.75/95	3.90/99	2.63/67	3.13/80	.203x.375 (5.2 x 9.5)	1.25/.63	6.25
200	50-0200-052	8	3.75/95	4.50/114	4.12/105	2.50/64	3.75/95	.203x.375 (5.2 x 9.5)	1.67/.83	8.33
250	50-0250-052	9	3.75/95	4.50/114	4.25/108	2.75/70	3.75/95	.203x.375 (5.2 x 9.5)	2.08/1.04	10.42
300	50-0300-052	11	3.75/95	4.50/114	4.75/121	3.13/80	3.75/95	.203x.375 (5.2 x 9.5)	2.50/1.25	12.50
375	50-0375-052	12	3.75/95	4.50/114	5.25/133	3.63/92	3.75/95	.203x.375 (5.2 x 9.5)	3.13/1.56	15.63
500	50-0500-052	17	4.38/111	5.25/133	5.88/149	3.63/92	4.38/111	.281x562 (7.1 x 14.3)	4.17/2.08	20.83
750	50-0750-052	25	4.38/111	5.25/133	7.50/191	5.25/133	4.38/111	.281x562 (7.1 x 14.3)	6.25/3.13	31.25
1000	50-1000-052	26	4.38/111	5.25/133	7.50/191	5.25/133	4.38/111	.281x562 (7.1 x 14.3)	8.33/4.17	41.67

Suffix -053

Primary 240 x 480, 230 x 460, 220 x 440 - Secondary 120, 115, 110 - Triple Rated									Primary Max Amps	Secondary Max Amps
VA	Catalog Number	Weight lbs	Dimensions (Inches/mm)			Mounting Dimensions (Inches/mm)			240/480 V	120 V
			Height A	Width B	Depth C	D	E	F		
50	50-0050-053	3	2.50/64	3.00/76	3.00/76	2.00/51	2.50/64	.203x.375 (5.2 x 9.5)	.21/.10	.42
75	50-0075-053	3	2.50/64	3.00/76	3.38/86	2.50/64	2.50/64	.203x.375 (5.2 x 9.5)	.31/.16	.63
100	50-0100-053	4	2.81/71	3.38/86	3.38/86	2.38/60	2.81/71	.203x.375 (5.2 x 9.5)	.42/.21	.83
150	50-0150-053	6	3.13/80	3.75/95	3.90/99	2.63/67	3.13/80	.203x.375 (5.2 x 9.5)	.63/.31	1.25
200	50-0200-053	8	3.75/95	4.50/114	4.12/105	2.50/64	3.75/95	.203x.375 (5.2 x 9.5)	.83/.42	1.67
250	50-0250-053	9	3.75/95	4.50/114	4.25/108	2.75/70	3.75/95	.203x.375 (5.2 x 9.5)	1.04/.52	2.08
300	50-0300-053	11	3.75/95	4.50/114	4.75/121	3.13/80	3.75/95	.203x.375 (5.2 x 9.5)	1.25/.63	2.50
375	50-0375-053	12	3.75/95	4.50/114	5.25/133	3.63/92	3.75/95	.203x.375 (5.2 x 9.5)	1.56/.78	3.13
500	50-0500-053	17	4.38/111	5.25/133	5.88/149	3.63/92	4.38/111	.281x562 (7.1 x 14.3)	2.08/1.04	4.17
750	50-0750-053	25	4.38/111	5.25/133	7.50/191	5.25/133	4.38/111	.281x562 (7.1 x 14.3)	3.13/1.56	6.25
1000	50-1000-053	26	4.38/111	5.25/133	7.50/191	5.25/133	4.38/111	.281x562 (7.1 x 14.3)	4.17/2.08	8.33
1500	50-1500-053	32	5.62/143	6.38/162	7.00/178	4.50/114	5.31/135	.312x.625 (7.9 x 15.9)	6.25/3.13	12.50
2000	50-2000-053	38	5.62/143	6.38/162	7.62/194	5.00/127	5.31/135	.312x.625 (7.9 x 15.9)	8.33/4.17	16.67
3000	50-3000-053	50	6.62/168	7.50/191	7.75/197	4.75/121	6.75/171	.312x.625 (7.9 x 15.9)	12.50/6.25	25.00
5000	50-5000-053	70	6.62/168	7.5/191	10.25/	6.88/	6.75/171	.312x.625 (7.9 x 15.9)	20.83/10.42	41.67

Dimensions and weights may change. Consult factory for Certified Drawings.



Suffix -054

Primary 208 - Secondary 120									Primary Max Amps	Secondary Max Amps
VA	Catalog Number	Weight lbs	Dimensions (Inches/mm)			Mounting Dimensions (Inches/mm)				
			Height A	Width B	Depth C	D	E	F	208 V	120 V
50	50-0050-054	3	2.50/64	3.00/76	3.00/76	2.00/51	2.50/64	.203x.375 (5.2 x 9.5)	.24	.42
75	50-0075-054	3	2.50/64	3.00/76	3.38/86	2.50/64	2.50/64	.203x.375 (5.2 x 9.5)	.36	.63
100	50-0100-054	4	2.81/71	3.38/86	3.38/86	2.38/60	2.81/71	.203x.375 (5.2 x 9.5)	.48	.83
150	50-0150-054	6	3.13/80	3.75/95	3.90/99	2.63/67	3.13/80	.203x.375 (5.2 x 9.5)	.72	1.25
200	50-0200-054	8	3.75/95	4.50/114	4.12/105	2.50/64	3.75/95	.203x.375 (5.2 x 9.5)	.96	1.67
250	50-0250-054	9	3.75/95	4.50/114	4.25/108	2.75/70	3.75/95	.203x.375 (5.2 x 9.5)	1.20	2.08
300	50-0300-054	11	3.75/95	4.50/114	4.75/121	3.13/80	3.75/95	.203x.375 (5.2 x 9.5)	1.44	2.50
375	50-0375-054	12	3.75/95	4.50/114	5.25/133	3.63/92	3.75/95	.203x.375 (5.2 x 9.5)	1.80	3.13
500	50-0500-054	17	4.38/111	5.25/133	5.88/149	3.63/92	4.38/111	.281x562 (7.1 x 14.3)	2.40	4.17
750	50-0750-054	25	4.38/111	5.25/133	7.50/191	5.25/133	4.38/111	.281x562 (7.1 x 14.3)	3.61	6.25
1000	50-1000-054	26	4.38/111	5.25/133	7.50/191	5.25/133	4.38/111	.281x562 (7.1 x 14.3)	4.81	8.33
1500	50-1500-054	32	5.62/143	6.38/162	7.00/178	4.50/114	5.31/135	.312x.625 (7.9 x 15.9)	7.21	12.50
2000	50-2000-054	38	5.62/143	6.38/162	7.62/194	5.00/127	5.31/135	.312x.625 (7.9 x 15.9)	9.62	16.67
3000	50-3000-054	50	6.62/168	7.50/191	7.75/197	4.75/121	6.75/171	.312x.625 (7.9 x 15.9)	14.42	25.00

Suffix -056

Primary 600/575/550 - Secondary 120/115/110 Triple Rated									Primary Max Amps	Secondary Max Amps
VA	Catalog Number	Weight lbs	Dimensions (Inches/mm)			Mounting Dimensions (Inches/mm)				
			Height A	Width B	Depth C	D	E	F	600 V	120 V
50	50-0050-056	3	2.50/64	3.00/76	3.00/76	2.00/51	2.50/64	.203x.375 (5.2 x 9.5)	.08	.42
75	50-0075-056	3	2.50/64	3.00/76	3.38/86	2.50/64	2.50/64	.203x.375 (5.2 x 9.5)	.13	.63
100	50-0100-056	4	2.81/71	3.38/86	3.38/86	2.38/60	2.81/71	.203x.375 (5.2 x 9.5)	.17	.83
150	50-0150-056	6	3.13/80	3.75/95	3.90/99	2.63/67	3.13/80	.203x.375 (5.2 x 9.5)	.25	1.25
200	50-0200-056	8	3.75/95	4.50/114	4.12/105	2.50/64	3.75/95	.203x.375 (5.2 x 9.5)	.33	1.67
250	50-0250-056	9	3.75/95	4.50/114	4.25/108	2.75/70	3.75/95	.203x.375 (5.2 x 9.5)	.42	2.08
300	50-0300-056	11	3.75/95	4.50/114	4.75/121	3.13/80	3.75/95	.203x.375 (5.2 x 9.5)	.50	2.50
375	50-0375-056	12	3.75/95	4.50/114	5.25/133	3.63/92	3.75/95	.203x.375 (5.2 x 9.5)	.63	3.13
500	50-0500-056	17	4.38/111	5.25/133	5.88/149	3.63/92	4.38/111	.281x562 (7.1 x 14.3)	.83	4.17
750	50-0750-056	25	4.38/111	5.25/133	7.50/191	5.25/133	4.38/111	.281x562 (7.1 x 14.3)	1.25	6.25
1000	50-1000-056	26	4.38/111	5.25/133	7.50/191	5.25/133	4.38/111	.281x562 (7.1 x 14.3)	1.67	8.33
1500	50-1500-056	32	5.62/143	6.38/162	7.00/178	4.50/114	5.31/135	.312x.625 (7.9 x 15.9)	2.50	12.50
2000	50-2000-056	38	5.62/143	6.38/162	7.62/194	5.00/127	5.31/135	.312x.625 (7.9 x 15.9)	3.33	16.67
3000	50-3000-056	50	6.62/168	7.50/191	7.75/197	4.75/121	6.75/171	.312x.625 (7.9 x 15.9)	5.00	25.00

Suffix -058

Primary 220/380/415 - Secondary 95/115									Primary Max Amps	Secondary Max Amps
VA	Catalog Number	Weight lbs	Dimensions (Inches/mm)			Mounting Dimensions (Inches/mm)				
			Height A	Width B	Depth C	D	E	F	220/380/415 V	95/115 V
250	50-0250-058	11	3.75/95	4.50/114	4.81/122	3.38/86	3.75/95	.203x.375 (5.2 x 9.5)	1.14/66/60	2.63/2.17
500	50-0500-058	22	4.38/111	5.25/133	6.63/168	4.60/117	4.38/111	.281x562 (7.1 x 14.3)	2.27/1.32/1.20	5.26/4.35
750	50-0750-058	23	4.25/108	5.75/146	7.38/187	4.38/111	4.94/125	.281x562 (7.1 x 14.3)	3.41/1.97/1.81	7.89/6.52
1000	50-1000-058	32	5.31/135	6.38/162	6.75/171	4.50/114	5.31/135	.312x.625 (7.9 x 15.9)	4.5/2.6/2.4	10.5/8.7
1500	50-1500-058	41	6.25/159	7.50/191	6.25/159	4.00/102	6.75/171	.312x.625 (7.9 x 15.9)	6.8/3.9/3.6	15.7/13.0
2000	50-2000-058	49	6.25/159	7.50/191	7.80/198	4.75/121	6.75/171	.312x.625 (7.9 x 15.9)	9.0/5.2/4.8	21.0/17.3
3000	50-3000-058	75	6.25/159	7.50/191	9.88/251	6.88/175	6.75/171	.312x.625 (7.9 x 15.9)	13.6/7.8/7.2	31.5/26.0
5000	50-5000-058	113	7.50/191	9.00/229	9.12/232	6.93/176	7.50/191	.437x.750 (11.1 x 19.1)	22.7/13.1/12.0	52.6/43.4

Dimensions and weights may change. Consult factory for Certified Drawings.



Suffix -059

Primary - Secondary 208/500 - 85/100/110 220/380/440/550 - 91/110/120 230/400/460/575 - 95/115/125 240/416/480/600 - 99/120/130									Secondary Max Amps
VA	Catalog Number	Weight lbs	Dimensions (Inches/mm)			Mounting Dimensions (Inches/mm)			
			Height A	Width B	Depth C	D	E	F	
150	50-0250-059	11	4.38/111	5.25/133	4.57/116	2.63/	4.38/111	.281x562 (7.1 x 14.3)	1.25
250	50-0250-059	15	4.38/111	5.25/133	5.25/133	3.38/86	4.38/111	.281x562 (7.1 x 14.3)	2.25
375	50-0375-059	18	4.25/108	5.75/146	6.25/159	3.44/	4.94/	.281x562 (7.1 x 14.3)	3.2
500	50-0500-059	22	4.25/108	5.75/146	6.68/	4.38/111	4.94/	.281x562 (7.1 x 14.3)	4.5
750	50-0750-059	32	5.31/135	6.38/162	6.75/170	4.50/114	5.31/135	.312x.625 (7.9 x 15.9)	6.25
1000	50-1000-059	35	5.31/135	6.38/162	7.25/	5.00/	5.31/135	.312x.625 (7.9 x 15.9)	9
1500	50-1500-059	53	6.25/159	7.50/191	8.63/	5.25/	6.75/171	.312x.625 (7.9 x 15.9)	15
2000	50-2000-059	60	6.25/159	7.50/191	8.75/	5.80/	6.75/171	.312x.625 (7.9 x 15.9)	20
3000	50-3000-059	74	6.25/159	7.50/191	10.25/	6.88/	6.75/171	.312x.625 (7.9 x 15.9)	25

Suffix -134

Primary 240 x 480, 230 x 460, 220 x 440 - Secondary 120/240, 115/230, 110/220 - Triple Rated									Primary Max Amps	Secondary Max Amps
VA	Catalog Number	Weight lbs	Dimensions (Inches/mm)			Mounting Dimensions (Inches/mm)				
			Height A	Width B	Depth C	D	E	F	240/480 V	120/240 V
50	50-0050-134	3	2.50/64	3.00/76	3.00/76	2.00/51	2.50/64	.203x.375 (5.2 x 9.5)	.21/.10	.42/21
75	50-0075-134	3	2.50/64	3.00/76	3.38/86	2.50/64	2.50/64	.203x.375 (5.2 x 9.5)	.31/.16	.63/.31
100	50-0100-134	4	2.81/71	3.38/86	3.38/86	2.38/60	2.81/71	.203x.375 (5.2 x 9.5)	.42/.21	.83/.42
150	50-0150-134	6	3.13/80	3.75/95	3.90/99	2.63/67	3.13/80	.203x.375 (5.2 x 9.5)	.63/.31	1.25/.63
200	50-0200-134	8	3.75/95	4.50/114	4.12/105	2.50/64	3.75/95	.203x.375 (5.2 x 9.5)	.83/.42	1.67/.83
250	50-0250-134	9	3.75/95	4.50/114	4.25/108	2.75/70	3.75/95	.203x.375 (5.2 x 9.5)	1.04/.52	2.08/1.04
300	50-0300-134	11	3.75/95	4.50/114	4.75/121	3.13/80	3.75/95	.203x.375 (5.2 x 9.5)	1.25/.63	2.50/1.25
375	50-0375-134	12	3.75/95	4.50/114	5.25/133	3.63/92	3.75/95	.203x.375 (5.2 x 9.5)	1.56/.78	3.13/1.56
500	50-0500-134	17	4.38/111	5.25/133	5.88/149	3.63/92	4.38/111	.281x562 (7.1 x 14.3)	2.08/1.04	4.17/2.08
750	50-0750-134	25	4.38/111	5.25/133	7.50/191	5.25/133	4.38/111	.281x562 (7.1 x 14.3)	3.13/1.56	6.25/3.13
1000	50-1000-134	26	4.38/111	5.25/133	7.50/191	5.25/133	4.38/111	.281x562 (7.1 x 14.3)	4.17/2.08	8.33/4.17
1500	50-1500-134	32	5.62/143	6.38/162	7.00/178	4.50/114	5.31/135	.312x.625 (7.9 x 15.9)	6.25/3.13	12.50/6.25
2000	50-2000-134	38	5.62/143	6.38/162	7.62/194	5.00/127	5.31/135	.312x.625 (7.9 x 15.9)	8.33/4.17	16.67/8.33
3000	50-3000-134	50	6.62/168	7.50/191	7.75/197	4.75/121	6.75/171	.312x.625 (7.9 x 15.9)	12.50/6.25	25.00/12.50

Dimensions and weights may change. Consult factory for Certified Drawings.

50 Series

Suffix -052				
Primary			Secondary	
Voltage	Jumper	Connect Incoming Lines To	Voltage	Connect Load To
120	H1 to H3 & H2 to H4	H1 & H4	24	X1 & X2
240	H2 to H3	H1 & H4		

Suffix -053				
Primary			Secondary	
Voltage	Jumper	Connect Incoming Lines To	Voltage	Connect Load To
240	H1 to H3 & H2 to H4	H1 & H4	120	X1 & X2
480			115	
460	H2 to H3	H1 & H4	110	
440				

Suffix -054				
Primary			Secondary	
Voltage	Jumper	Connect Incoming Lines To	Voltage	Connect Load To
208	-	H1 & H2	120	X1 & X2

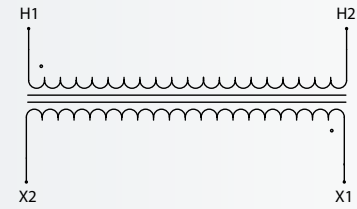
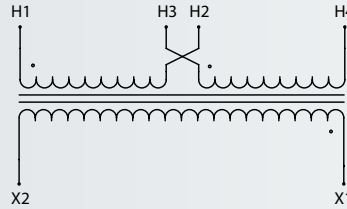
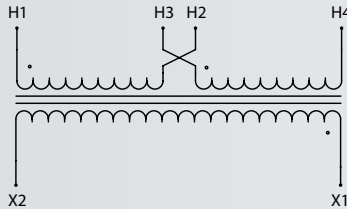

Suffix -056				
Primary			Secondary	
Voltage	Jumper	Connect Incoming Lines To	Voltage	Connect Load To
600	-	H1 & H2	120	X1 & X2
575			115	X1 & X2
550			110	X1 & X2

Suffix -058				
Primary			Secondary	
Voltage	Jumper	Connect Incoming Lines To	Voltage	Connect Load To
220	-	H1 & H2	95	X1 & X2
380	-	H1 & H3		
415	-	H1 & H4	115	X1 & X3

Suffix -134					
Primary			Secondary		
Voltage	Jumper	Connect Incoming Lines To	Voltage	Jumper	Connect Load To
240	H1 to H3 & H2 to H4	H1 & H4	120	X1 to X3 & X2 to X4	X1 & X4
480			120	X1 to X3 & X2 to X4	X1 & X4
460	H2 to H3	H1 & H4	115	&	X1 & X4
440			110	X2 to X4	
240	H1 to H3 & H2 to H4	H1 & H4	240	X2 to X3	X1 & X4
230			230		
220			220		
480			240		
460	H2 to H3	H1 & H4	230	X2 to X3	X1 & X4
440			220		

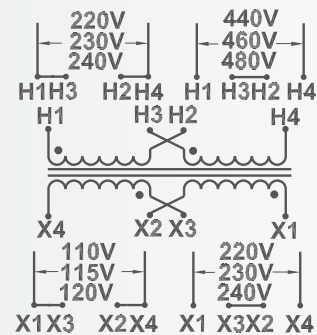
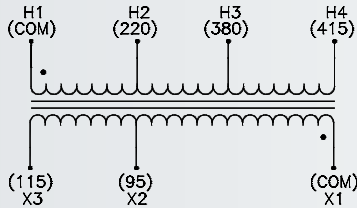
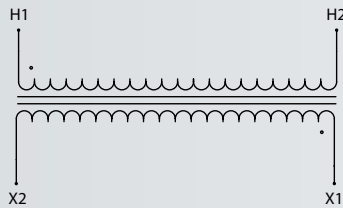

Suffix -059						
Primary				Secondary		
Connect Incoming Lines To H1 & H2	Connect Incoming Lines To H1 & H3	Connect Incoming Lines To H1 & H4	Connect Incoming Lines To H1 & H5	Connect Load To X1 & X2	Connect Load To X1 & X3	Connect Load To X1 & X4
208	-	-	500	85	100	110
220	380	440	550	91	110	120
230	400	460	575	95	115	125
240	416	480	600	99	120	130

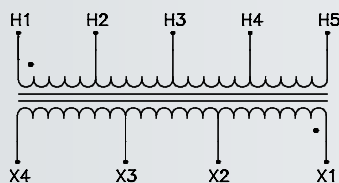

Series 50 Primary Fuse Kit BR-734

I Fuse Kit BR-734

- Meets UL 508
- Meets NEC Article 450
- Uses Class CC Fuses

Installation Procedure

- Loosen bolts holding transformer to the panel backplate.
- Slide the BR-734 bracket over the transformer.
- Connect the Fuse Holder leads to the transformer terminals with the Jumper Leads furnished.

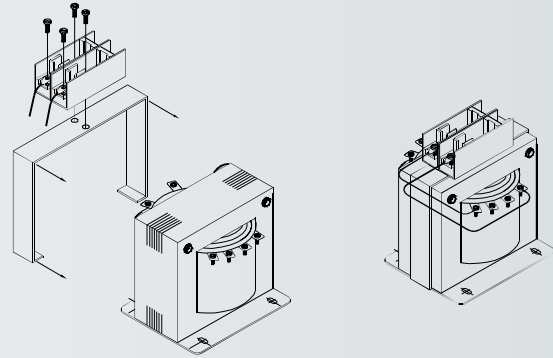

Series 50 Recommended Fuse Type by Manufacturer

Manufacturer	Bussman	Gould	Littlefuse
Primary Fuse Type	FNQ-R	ATQR / ATDR	KLDR / CCRM
Secondary Fuse Type Fuse Holder 265-B	FNM / FNQ (250V) (500v)	TRM / ATQ (250V) (500V)	FLM / FLQ (250V) (500V)
Secondary Fuse Type Fuse Holder GLF 1 1/4	MDQ (250V)	GDL (250V)	3AB (250V)

Note: Fuses sold separately.

Primary Fuse Holder Brackets for 50 Series							
Series VA	052	053	054	056	058	059	134
50	BR-734-1	BR-734-1	BR-734-1	BR-734-1			BR-734-1
75	BR-734-1	BR-734-1	BR-734-1	BR-734-1			BR-734-1
100	BR-734-2	BR-734-2	BR-734-2	BR-734-2			BR-734-2
150	BR-734-3	BR-734-3	BR-734-3	BR-734-3		BR-734-6	BR-734-3
200	BR-734-4	BR-734-4	BR-734-4	BR-734-4			BR-734-4
250	BR-734-4	BR-734-4	BR-734-4	BR-734-4	BR-734-4	BR-734-6	BR-734-4
300	BR-734-4	BR-734-4	BR-734-4	BR-734-4			BR-734-4
375	BR-734-4	BR-734-4	BR-734-4	BR-734-4		BR-734-5	BR-734-4
500	BR-734-6	BR-734-6	BR-734-6	BR-734-6	BR-734-6	BR-734-5	BR-734-6
750	BR-734-6	BR-734-6	BR-734-6	BR-734-6	BR-734-5	BR-734-7	BR-734-6
1000	BR-734-6	BR-734-6	BR-734-6	BR-734-6	BR-734-7	BR-734-7	BR-734-6
1500		BR-734-7	BR-734-7	BR-734-7	BR-734-8	BR-734-8	BR-734-7
2000		BR-734-7	BR-734-7	BR-734-7	BR-734-8	BR-734-8	BR-734-7
3000		BR-734-8	BR-734-8	BR-734-8	BR-734-8	BR-734-8	BR-734-8
5000		BR-734-8			BR-734-9		

Series 50 Secondary Fuse Kits

Fuse Kit 265 B

- Meets UL 508
- Meets NEC Article 450
- Uses Class 13/32 x 1 1/2 Fuses

Installation Procedure

- Remove the #10 screw in the transformer terminal to be fused.
- Fasten 265 B Fuse Holder to the transformer terminal with the longer #10 screw provided, as shown in the diagram.
- Connect the load lead to the terminal provided on the 265 B Fuse Holder

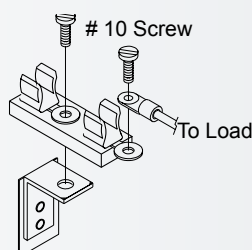

Note: Fuses sold separately.

Fuse Kit GLF 1 1/4

- Meets UL 508
- Meets NEC Article 450
- Uses Class 1/4 x 1 1/4 Fuses

Installation Procedure

- Remove the #6 screw in the transformer terminal to be fused.
- Fasten GLF 1 1/4 Fuse Holder to the transformer terminal with the longer #6 screw provided, as shown in the diagram.
- Connect the load lead to the terminal provided on the GLF 1 1/4 Fuse Holder

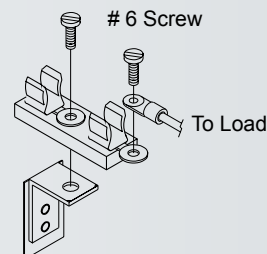

Selecting and Sizing an Industrial Control Transformer

Selecting The Correct Transformer VA Capacity

Once Selection VA is calculated by one of the above methods, the selection charts on the right can be used.

Calculated Selection Inrush VA should be equal to or greater than the maximum inrush VA from the chart. To assure adequate capacity, a power factor of 40% has been employed in the selection chart.

The use of the 90% or 95% of rated secondary voltage column is recommended for transformer selection. The use of the 85% rated secondary voltage column may not provide adequate voltage output to accommodate existing below normal distribution voltages and voltage dips during equipment and motor startups.

Example:
Sizing Data:

Sealed VA = 270 VA
Inrush VA = 1,728 VA

Using the formula in Method 1:
Selection Inrush VA

$$= \sqrt{(VA \text{ sealed})^2 + (VA \text{ inrush})^2}$$

$$= \sqrt{(270)^2 + (1,728)^2}$$

$$= 1,749 \text{ VA}$$

In the above example, at 95% of rated secondary voltage (.4 PF), the correct transformer size is 500 VA.

Using the formula in Method 2:
= VA Sealed + VA Inrush
= 270 + 1728
= 1,998 VA

In the above example, at 95% of rated secondary voltage (.4 PF), the correct transformer size is 750 VA.

Conversion to kVA:

The formula used to convert single phase VA to kVA is as follows:

$$kVA = \frac{VA \text{ (Volt Amperes)}}{1000}$$

Typical Va Requirements of 3 pole, 60 Hz, 120 volt contractors are listed in the chart below:

Selection Inrush VA Charts

Series IC Inrush VA		Selection Inrush VA at 85%, 90%, and 95% of Rated Secondary Voltage					
VA Rating	Catalog Number	20% Power Factor			40% Power Factor		
		85%	90%	95%	85%	90%	95%
50	IC-0050-xxx	330	270	210	240	200	140
75	IC-0075-xxx	520	430	340	370	310	220
100	IC-0100-xxx	840	690	540	590	480	352
150	IC-0150-xxx	1390	1150	900	1280	1030	722
250	IC-0250-xxx	2850	2300	1850	1980	1650	1060
350	IC-0350-xxx	3980	3200	2580	2900	2400	1680
500	IC-0500-xxx	7400	6130	4800	5200	4340	3200
750	IC-0750-xxx	12000	10400	8100	8800	7400	5100
1000	IC-1000-xxx	19100	15700	11400	13500	11200	7700

Series 50 Inrush VA		Selection Inrush VA at 85%, 90%, and 95% of Rated Secondary Voltage					
VA Rating	Catalog Number	20% Power Factor			40% Power Factor		
		85%	90%	95%	85%	90%	95%
50	50-0050-xxx	270	230	190	250	185	140
75	50-0075-xxx	580	480	350	460	340	250
100	50-0100-xxx	820	660	490	520	410	305
150	50-0150-xxx	1350	1000	820	1250	900	640
200	50-0200-xxx	1920	1380	840	1320	960	690
250	50-0250-xxx	2780	1990	1190	1840	1290	790
300	50-0300-xxx	3600	2680	1630	2470	1800	1070
375	50-0375-xxx	4580	3300	2050	3100	2250	1300
500	50-0500-xxx	6150	4450	2750	4350	3100	1900
750	50-0750-xxx	10200	7300	4300	8450	5500	3700
1000	50-1000-xxx	11800	8400	4600	8900	5900	3950
1500	50-1500-xxx	22400	16300	9200	16500	12900	6900
2000	50-2000-xxx	24600	16800	9800	19600	13300	7200
3000	50-3000-xxx	32500	23600	13900	26500	19600	11700
5000	50-5000-xxx	62000	46000	26800	49800	37200	29500

Series HC Inrush VA		Selection Inrush VA at 85%, 90%, and 95% of Rated Secondary Voltage					
VA Rating	Catalog Number	20% Power Factor			40% Power Factor		
		85%	90%	95%	85%	90%	95%
50	HC-0050-xxx	270	230	190	250	185	140
75	HC-0075-xxx	580	480	350	460	340	250
100	HC-0100-xxx	810	630	440	620	530	350
150	HC-0150-xxx	1350	1050	820	1250	900	640
250	HC-0250-xxx	2040	1610	1170	1940	1420	980
375	HC-0375-xxx	3240	2450	2030	2900	2050	1650
500	HC-0500-xxx	5600	4050	2900	4500	3500	2350
750	HC-0750-xxx	9300	6650	4800	7100	5650	3850
1000	HC-1000-xxx	14500	11000	7900	12600	9700	5800
1500	HC-1500-xxx	24200	18700	13500	19500	14100	9800
2000	HC-2000-xxx	37500	27500	19800	27500	20500	14000

Selecting and Sizing an Industrial Control Transformer

Control Circuit Overcurrent Protection

Current North American Standards specify overcurrent protection on all control circuit transformers. These standards include the US National Electric Code® and UL 508. Specified overcurrent protection may be accomplished by one of two options.

Option 1: Provide primary overcurrent protection based on the parameters below.

Option 2: Provide both primary and secondary overcurrent protection. When this option is followed,

the primary overcurrent device should be rated at no more than 250% of rated primary current and the secondary overcurrent device at no more than 125% of rated secondary current.

Option 2 is the preferred method of overcurrent protection, as it minimizes nuisance trips due to startup inrush.

In either method, it is recommended that Class CC, time delay primary fuses be used in order to help prevent nuisance trips.

Recommended Primary Fuse Chart

Primary Voltage																		
VA ↓	115	120	200	208	220	230	240	277	380	400	416	440	460	480	550	575	600	VA ↓
50	1 ¼	1 ¼	¾	¾	¾	¾	¾	½	¾	¾	¾	¾	¾	¾	¼	¼	¾	50
75	1 ⅝	1 ⅝	1 ⅝	1	1	¾	¾	¾	½	½	½	½	¾	¾	¾	¾	¾	75
100	2 ½	2 ¼	1 ½	1 ⅝	1 ¼	1 ¼	1 ¼	1	¾	¾	¾	¾	¾	¾	½	½	½	100
150	3 ½	3 ½	2 ¼	2	2	1 ⅝	1 ⅝	1 ⅝	1 ⅝	1 ⅝	1	1	¾	¾	¾	¾	¾	150
200	5	5	3	2 ⅝	2 ½	2 ½	2 ¼	2	1 ½	1 ½	1 ⅝	1 ¼	1 ¼	1 ¼	1	1	¾	200
250	4	4	3 ½	3 ½	3 ⅝	3 ⅝	3	2 ½	1 ⅝	1 ⅝	1 ⅝	1 ⅝	1 ⅝	1 ½	1 ¼	1 ¼	1 ¼	250
300	5	5	4 ½	4	4	3 ½	3 ½	3 ⅝	2 ¼	2 ¼	2	2	1 ⅝	1 ⅝	1 ⅝	1 ½	1 ½	300
350	5	5	5	5	4 ½	4 ½	4	3 ½	2 ½	2 ½	2 ½	2 ¼	2 ¼	2	1 ⅝	1 ⅝	1 ⅝	350
500	8	8	4 ½	5	4	4	3 ½	5	3 ½	3 ½	3 ½	3 ⅝	3 ⅝	3	2 ½	2 ½	2 ¼	500
750	10	10	7	6	6	6	5	5	5 ⅝	5 ⅝	5	5	4 ½	4 ½	4	3 ½	3 ½	750
1000	15	15	9	8	8	8	7	6	4 ½	4 ½	4	4	3 ½	3 ½	5	5	5	1000
1500	20	15	15	12	12	10	10	9	6 ¼	6 ¼	6	6	6	5	4 ½	4 ½	4	1500
2000	25	20	15	15	15	15	15	12	9	9	8	8	8	7	6	6	6	2000
3000		20	20	20	20	15	15	15	12	12	12	12	12	10	9	9	9	3000
5000				30	30	30	30	25	20	15	15	15	15	15	15	15	15	5000

Recommended Secondary Fuse Chart

Secondary Voltage												
VA ↓	24	95	100	110	115	120	125	130	220	230	240	VA ↓
50	3 ⅝	¾	¾	¾	¾	¾			¾	¾	¾	50
75	5	1 ¼	1 ¼	1 ⅝	1	1			½	½	½	75
100	6 ¼	1 ⅝	1 ⅝	1 ½	1 ⅝	1 ¼			¾	¾	¾	100
150	10	2 ½	2 ½	2 ¼	2	2			1 ⅝	1	1	150
200	12	3 ½	3 ⅝	3	2 ⅝	2 ½			1 ½	1 ⅝	1 ¼	200
250	15	4	4	3 ½	3 ½	3 ⅝			1 ⅝	1 ⅝	1 ⅝	250
300	20	5	5	4 ½	4	4			2 ¼	2	2	300
350	20	6	5 ⅝	5	5	4 ½			2 ½	2 ½	2 ¼	350
500	30	8	8	7 ½	7	6 ¼			3 ½	3 ½	3 ⅝	500
750		12	12	10	10	10			5 ⅝	5	5	750
1000		15	15	15	15	15			7	7	7	1000
1500		20	20	20	20	20			9	8	8	1500
2000		30	30	20	30	20			15	15	12	2000
3000									20	20	20	3000
5000									30	30	30	5000

Transformers and Custom Magnetics

Factory and Local Warehouse

Stocks for:

- Industrial Control Transformers
- General Purpose
 - Single Phase
 - Three Phase
- Motor Drive Isolation
- Control Transformers
- K - Factor Transformers
- High Voltage Ignition
 - Gas Ignition
 - Oil Ignition
 - Solid State
- Transformer Lighting Disconnects
- Signaling
- Hospital Isolation
- Epoxy Encapsulated
- CE Marked Transformers
- Constant Voltage
- Auto Transformers
- High Voltage Transformers

Custom Designs Available:

- Domestic & Export Voltages
- Custom Colors
- Special Frequencies
- Custom Enclosures
- Match Current or Custom Dimensions
- Core & Coil Units
- CE Marked Transformers
- Chokes
- Reactors
- Comprehensive Family Approvals for



Dongan Electric Manufacturing Company

2987 Franklin Street
Detroit, MI 48207 USA

800.428.2626 • 313.567.8500
Fax: 313.567.8828

www.dongan.com • sales@dongan.com

Pioneer Transformer Company
A Wholly Owned Subsidiary
500 Cedar Street
Pioneer, OH 43554 USA

