

mm inch

FEATURES

- High sensitivity: 150 mW/200 mW
- A wide range of ambient temperature: -40°C to $+70^{\circ}\text{C}$ -40°F to $+158^{\circ}\text{F}$
- Sealed construction
- Rating: 1 A 30 V DC

RoHS Directive compatibility information
<http://www.nais-e.com/>

SPECIFICATIONS

Contact

Arrangement	1 Form C	
Initial contact resistance, max. (By voltage drop 6 V DC 1 A)	100 m Ω	
Contact material	Gold-clad silver	
Rating (resistive)	Nominal switching capacity	1 A 30 V DC
	Max. switching power	30 W
	Max. switching voltage	60 V DC
	Max. switching current	1 A
	Max. carrying current	2 A
Expected life (min. operations)	Min. switching capacity (Reference value) ^{#1}	1 mA, 1 V DC
	Mechanical (at 180 cpm)	10^7
	Electrical (at 20 cpm) 1 A 30 V DC	10^5

Coil

Nominal operating power	Standard type	200 mW
	High sensitivity type	150 mW

Note:

#1 This value can change due to the switching frequency, environmental conditions, and desired reliability level, therefore it is recommended to check this with the actual load.

Remarks

- * Specifications will vary with foreign standards certification ratings.
- *1 Measurement at same location as "Initial breakdown voltage" section
- *2 Detection current: 10mA
- *3 Excluding contact bounce time
- *4 Half-wave pulse of sine wave: 11ms; detection time: 10 μ s
- *5 Half-wave pulse of sine wave: 6ms
- *6 Detection time: 10 μ s
- *7 Refer to 6. Conditions for operation, transport and storage mentioned in AMBIENT ENVIRONMENT .

Characteristics (at 25°C 77°F, 50% Relative humidity)

Max. operating speed	20 cpm (at nominal voltage)	
Initial insulation resistance*1	Between contacts	Min. 100 M Ω at 500 V DC
	Between contact and coil	Min. 100 M Ω at 500 V DC
Initial breakdown voltage*2	Between open contacts	500 Vrms
	Between contacts and coil	1,000 Vrms
Operate time*3 (at nominal voltage)	Max. 5 ms	
Release time (without diode)*3 (at nominal voltage)	Max. 4 ms	
Temperature rise at nominal voltage Contact carrying current 1 A at 20°C	Max. 50°C	
Shock resistance	Functional*4	Min. 98 m/s ² (10 G)
	Destructive*5	Min. 980 m/s ² (100 G)
Vibration resistance	Functional*6	58.8 m/s ² {6 G}, 10 to 55 Hz at double amplitude of 1 mm
	Destructive	117.6 m/s ² {12 G}, 10 to 55 Hz at double amplitude of 2 mm
Conditions for operation, transport and storage*7 (Not freezing and condensing at low temperature)	Ambient temp.	-40°C to $+70^{\circ}\text{C}$ -40°F to $+158^{\circ}\text{F}$
	Humidity	5 to 85% R.H.
Unit weight	1.8 g .063 oz	

TYPICAL APPLICATIONS

- Automotive: Switching to small motor
 - 1) Automirror controller
 - 2) Retractable head light controller
- Push button device: Dial pulsing
- Low-voltage signal switching and motor control of small home appliances such as portable video tape recorders and audio devices.
- Operating of dish-control motors for PCs and word processors

ORDERING INFORMATION

Ex. HY 1 Z — 3V

Contact arrangement	Sensitivity	Coil voltage (DC)
1: 1 Form C	Nil: High sensitivity 150 mW Z: Standard 200 mW	1.5, 3, 4.5, 5, 6, 9, 12, 24 V

Standard packing: Tube: 50 pcs.; Case: 2,000 pcs.

TYPES AND COIL DATA (at 20°C 68°F)

200 mW Standard type

Part No.	Nominal voltage, V DC	Pick-up voltage, V DC (max.)	Drop-out voltage, V DC (min.)	Coil resistance, Ω (±10%)	Nominal operating current, mA	Nominal operating power, mW	Max. allowable voltage, V DC (at 70°C 158°F)
HY1Z-1.5V	1.5	1.125	0.15	11.25	133.3	200	1.8
HY1Z-3V	3	2.25	0.3	45	66.7	200	3.6
HY1Z-4.5V	4.5	3.375	0.45	101.2	44.5	200	5.4
HY1Z-5V	5	3.75	0.5	125	40	200	6
HY1Z-6V	6	4.5	0.6	180	33.3	200	7.2
HY1Z-9V	9	6.75	0.9	405	22.2	200	10.8
HY1Z-12V	12	9	1.2	720	16.7	200	14.4
HY1Z-24V	24	18	2.4	2,880	8.3	200	28.8

150 mW High sensitivity type

Part No.	Nominal voltage, V DC	Pick-up voltage, V DC (max.)	Drop-out voltage, V DC (min.)	Coil resistance, Ω (±10%)	Nominal operating current, mA	Nominal operating power, mW	Max. allowable voltage, V DC (at 70°C 158°F)
HY1-1.5V	1.5	1.125	0.15	15	100	150	2.1
HY1-3V	3	2.25	0.3	60	50	150	4.2
HY1-4.5V	4.5	3.375	0.45	135	33.3	150	6.3
HY1-5V	5	3.75	0.5	166	30.1	150	7
HY1-6V	6	4.5	0.6	240	25	150	8.4
HY1-9V	9	6.75	0.9	540	16.7	150	12.6
HY1-12V	12	9	1.2	960	12.5	150	16.8
HY1-24V	24	18	2.4	3,840	6.25	150	33.6

DIMENSIONS

mm inch

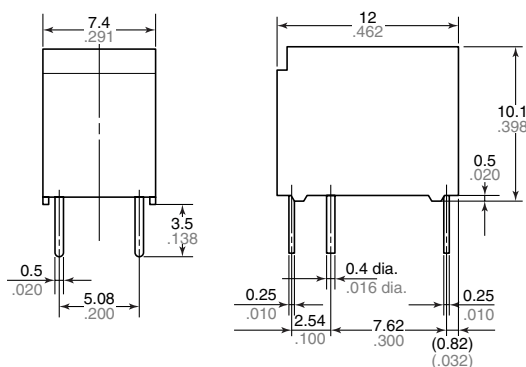

PC board pattern (Copper-side view)

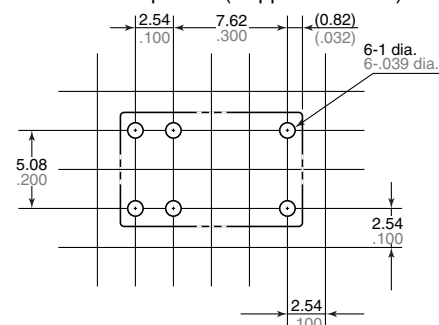

Schematic (Bottom view)

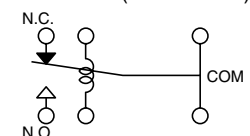

General tolerance: ±0.3 ±0.012

Tolerance: ±0.1 ±0.004

REFERENCE DATA

1. Maximum switching power

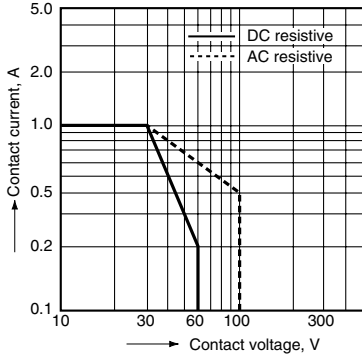

2. Life curve

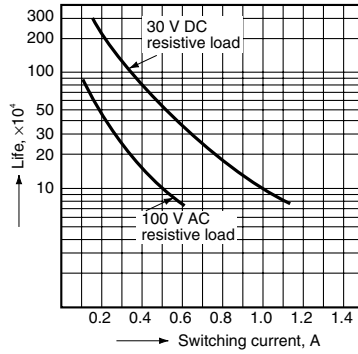

3. Mechanical life

Tested sample: HY1Z-12V, 10 pcs.
Ambient temperature: 20°C to 25°C 68°F to 77°F

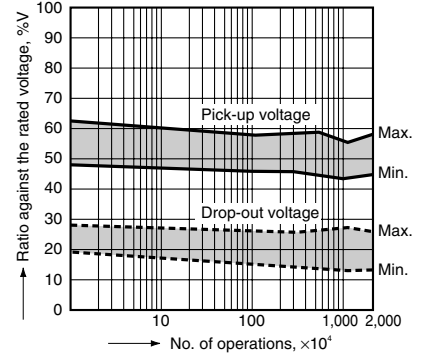

4. Electrical life

Tested sample: HY1-12V, 6 pcs.
Condition: 1 A 30 V DC resistive load, 30 cpm

Circuit:

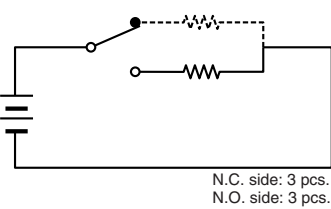

Change of pick-up and drop-out voltage

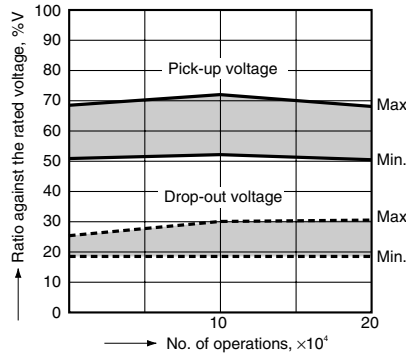

Change of contact resistance

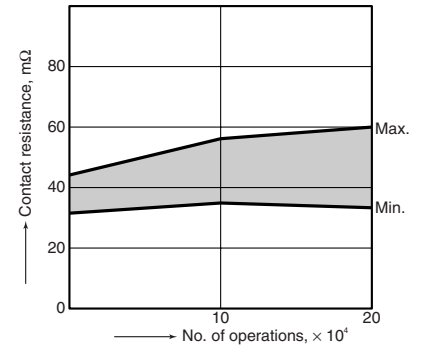

5-(1). Coil temperature rise (150 mW high sensitivity type)

Tested sample: HY1-9V, 5 pcs.
Ambient temperature: 24°C 75°F

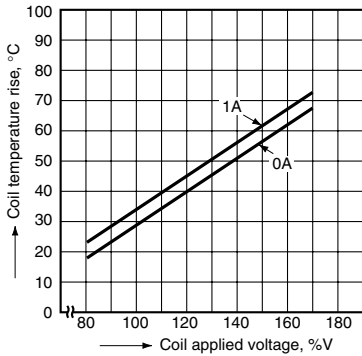

5-(2). Coil temperature rise (200 mW Standard type)

Tested sample: HY1Z-12V, 5 pcs.
Ambient temperature: 23°C 74°F

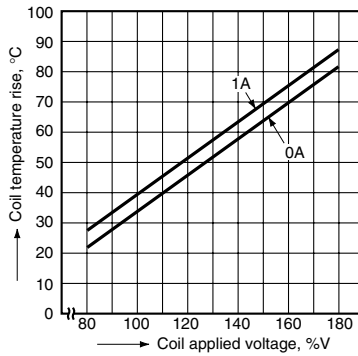

6. Operate/release time characteristics

Tested sample: HY1Z-12V, 5 pcs.
Ambient temperature: 25°C 77°F

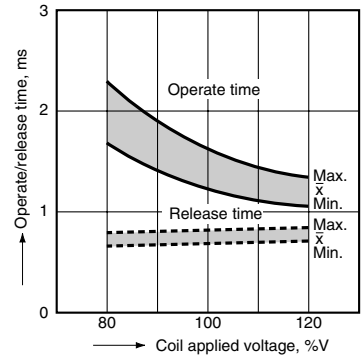

7. Distribution of pick-up and drop-out voltages

Tested sample: HY1-12V, 50 pcs.
Ambient temperature: 23°C 74°F

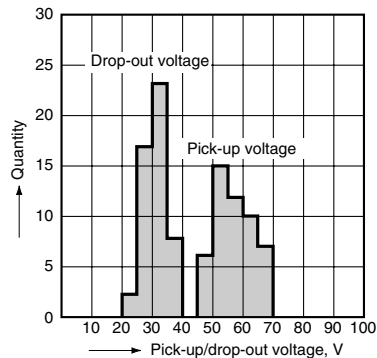

8. Distribution of contact resistance

Tested sample: HY1-12V, 50 pcs.
N.C. side N.O. side

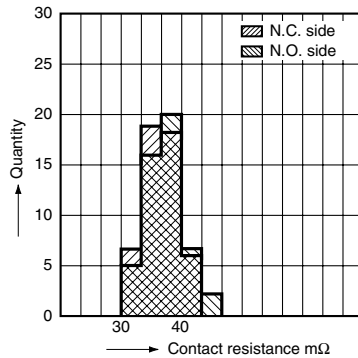

9. Malfunction shock

Tested sample: HY1Z-12V, 6 pcs.

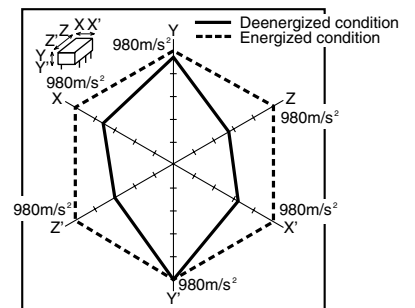

NOTE**Soldering and cleaning**

HY relays have the sealed construction. It is possible to do automatic soldering and automatic cleaning, but avoid the ultrasonic cleaning.

For cleaning, it is recommended that a fluorinated hydrocarbon or other alcoholic solvent be used.

For Cautions for Use, see Relay Technical Information.