



(2.54 mm) .100"

THROUGH-HOLE .025" SQ POST HEADER

Board Mates:

SSW, SSQ, SSM, ESW, ESQ, BCS, BSW, CES, SLW

Cable Mates:

IDSD, IDSS, SMSD, SMSS

SPECIFICATIONS

For complete specifications see www.samtec.com?TSW or www.samtec.com?HTSW

Insulator Material:

TSW: Black Glass Filled Polyester

HTSW: Natural Liquid Crystal Polymer

Terminal Material:

Phosphor Bronze

Plating:

Au or Sn over 50 μm (1.27 μm) Ni

Operating Temp Range:

-55 °C to +125 °C with Gold

-55 °C to +105 °C with Tin

Voltage Rating:

550 VAC mated with SSW;

500 VAC mated with BCS or ESQ;

450 VAC -RA/-RE mated with BCS or SSM

400 VAC mated with CES

RoHS Compliant: Yes

Lead-Free Solderable:

HTSW: Yes

TSW: No, Lead Wave Only

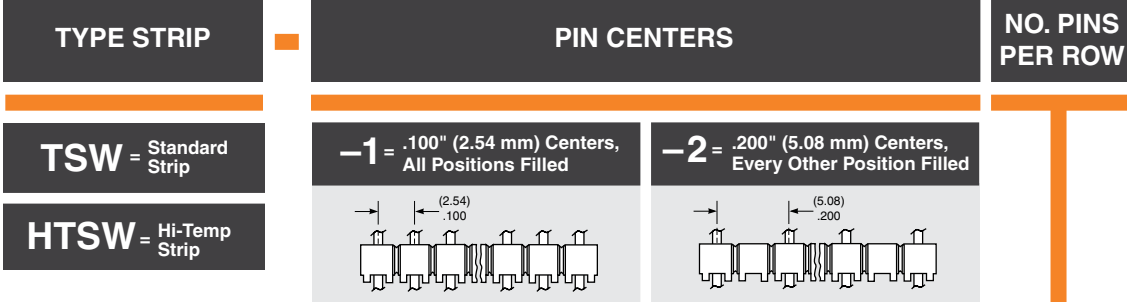

CURRENT RATING (PER PIN)						
TSW mated with						
ESW	SSW	SLW	SSQ	SSM	BCS	SNT
5.2 A	5.7 A	5.2 A	6.3 A	5.2 A	4.6 A	4.3 A

2 POSITIONS POWERED

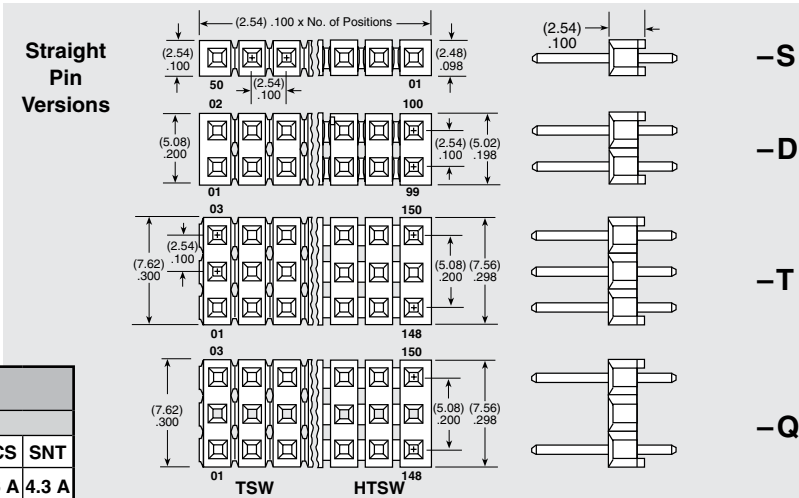

01 thru 50
= .100" (2.54 mm)
Center Version

RECOGNITIONS

For complete scope of recognitions see www.samtec.com/quality

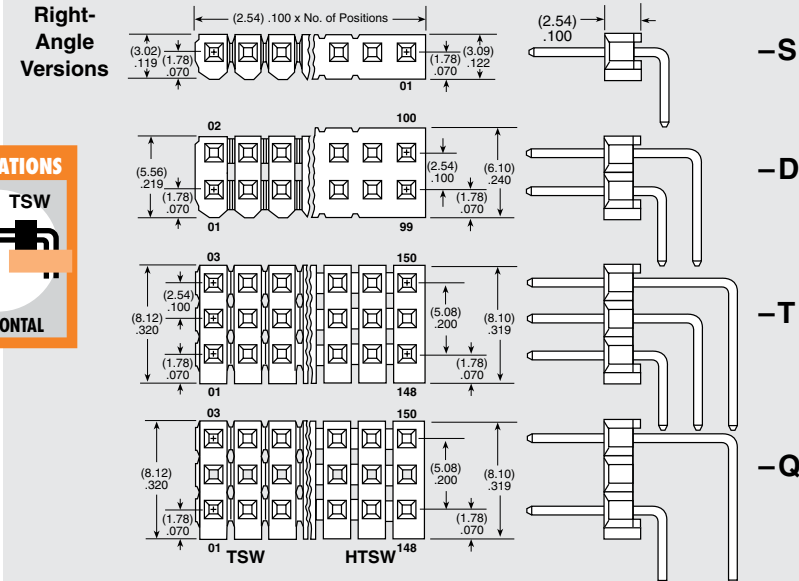
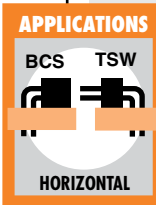

02 thru 25
= .200" (5.08 mm)
Center Version

ALSO AVAILABLE (MOQ Required)

- Other platings
- Contact Samtec.

Note: Some lengths, styles and options are non-standard, non-returnable.

Due to technical progress, all designs, specifications and components are subject to change without notice.

WWW.SAMTEC.COM

All parts within this catalog are built to Samtec's specifications. Customer specific requirements must be approved by Samtec and identified in a Samtec customer-specific drawing to apply.

TSW-109-10-F-D-RA

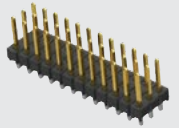

TSW-112-07-G-T

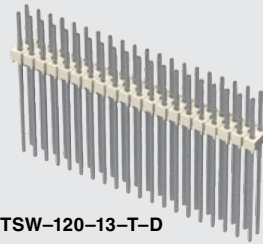
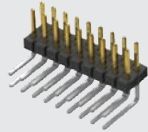

HTSW-120-13-T-D



TSW-114-16-G-S-RE

TSW, HTSW SERIES

LEAD STYLE

PLATING OPTION

ROW OPTION

OTHER OPTIONS

-F

= Gold flash on post, Matte Tin on tail

-L

= 10 μ" (0.25 μm) Gold on post, Matte Tin on tail

-G

= 10 μ" (0.25 μm) Gold on post, Gold flash on balance

-T

= Matte Tin

OTHER SOLUTIONS

- Elevated Right-angle option
- Shunts
- Contact Samtec

-S
= Single Row

-D
= Double Row

-T
= Triple Row

-Q
= Double Row (5.08 mm) .200" row space

-RA or -RE
= Right-angle

-NA
= Right-angle (using straight body for coplanar mating with SSW-RA series)

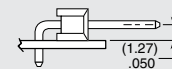

-LL
= Locking Lead

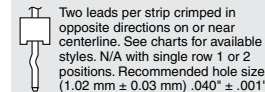

-LC

= Locking Clip (Styles -08 thru -13 & -22 only)

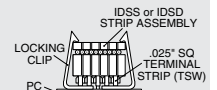

Requires 4 pin minimum (NA with -T, -Q, -RA or -RE)

-LA

= -RA Option with -LL Option

-“XXX”

= Polarized Position

Straight Pin Versions

(Specify "LEAD STYLE" from chart)

STYLE	A	B	C
* -05	(3.30) .130	(8.51) .335	(2.67) .105
* -06	(2.41) .095	(7.62) .300	(2.67) .105
* -07	(2.54) .100	(10.92) .430	
* -08	(5.08) .200	(13.46) .530	
-09	(10.16) .400	(18.54) .730	(5.84) .230
-10	(12.70) .500	(21.08) .830	
-11	(15.24) .600	(23.62) .930	
-12	(17.78) .700	(26.16) .1030	
-13	(22.86) .900	(31.24) .1230	
-14	(2.79) .110	(13.46) .530	(8.13) .320
* -15		(18.54) .730	(13.21) .520
* -16	(7.87) .310		(8.13) .320
* -17	(2.79) .110	(21.08) .830	(15.74) .620

* Available with -LL (Locking Lead) Option

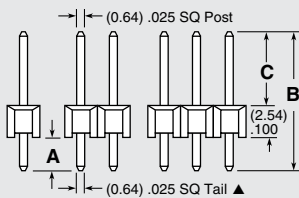

Specify -07 for best mate with IDXX Series IDC Cable

STYLE	A	B	C
* -18		(23.62) .930	(18.29) .720
* -19	(2.79) .110	(26.16) .1030	(20.83) .820
* -20		(31.24) .1230	(25.91) .1020
* -21		(36.32) .1430	(30.99) .1220
* -22	(7.62) .300	(16.00) .630	(5.84) .230
* -23	(2.92) .115	(11.30) .445	
* -24		(12.15) .490	(6.73) .265
* -25	(5.33) .210	(16.00) .630	(8.13) .320
▲ -26	(3.20) .126	(11.58) .456	
-27	(25.40) .1000	(33.78) .1330	(5.84) .230
-28	(20.32) .800	(28.70) .1130	
-29	(23.11) .910	(33.78) .1330	(8.13) .320
-30	(18.03) .710	(28.70) .1130	
+ -41	(0.89) .035	(9.27) .365	(5.84) .230
+ -42	(1.27) .050	(11.94) .470	(8.13) .320

+ Style -41 & -42 available with HTSW only.

▲ Except: Style -26 (0.46) .018 DIA Tail

Right-Angle Versions

(Specify "LEAD STYLE" from chart and select -RA or -RE from other options)

-RA LEAD STYLE	SINGLE (-S)		DOUBLE (-D)	TRIPLE (-T & -Q)
	A	C	A	A
-08	(2.29) .090		(2.29) .090	(2.29) .090
-09	(7.37) .290		(7.37) .290	(7.37) .290
-10	(9.91) .390	(5.84) .230	(9.91) .390	(9.91) .390
-11	(12.45) .490		(12.45) .490	(12.45) .490
-12	(14.99) .590		(14.99) .590	(14.99) .590
-13	(20.07) .790			N/A
* -16	(5.08) .200	(8.13) .320	(5.08) .200	(5.08) .200
* -21	(25.15) .990	(5.84) .230	N/A	N/A
* -22	(4.83) .190		(4.83) .190	(4.83) .190
* -25	(2.54) .100	(8.13) .320	(2.54) .100	(2.54) .100
-27	(22.61) .890	(5.84) .230	N/A	
-28	(17.53) .690		(17.53) .690	
-29	(20.32) .800	(8.13) .320	N/A	N/A
-30	(15.24) .600		(15.24) .600	

-RE LEAD STYLE	SINGLE A	C
-09	(4.83) .190	
-10	(7.37) .290	
-11	(9.91) .390	(5.84) .230
-12	(12.45) .490	
-13	(17.53) .690	
-16	(2.54) .100	(8.13) .320
-21	(22.61) .890	
-22	(2.29) .090	(5.84) .230
-27	(20.07) .790	
-28	(14.99) .590	

* Available with -LA (Locking Lead) Option

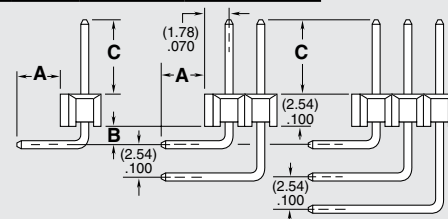

LEAD STYLE	B
-RA	(1.52) .060
-RE	(4.06) .160

Due to technical progress, all designs, specifications and components are subject to change without notice.

WWW.SAMTEC.COM

All parts within this catalog are built to Samtec's specifications. Customer specific requirements must be approved by Samtec and identified in a Samtec customer-specific drawing to apply.