

10 AMP POWER RELAY

HP RELAYS



RoHS Directive compatibility information
<http://www.mew.co.jp/ac/e/environment/>

FEATURES

1. High-capacity and long life

Mechanical life is more than 10 million operations and, with electrical life of more than 200,000 operations (resistive load 10 A; inductive load 7.5 A), the relay has excellent inductive load durability.

2. Easy mounting and wiring

The terminal arrangement is apparent at a glance and wiring is easy. Moreover, quick tab terminal is also possible.

3. Operation indicator option

Optional operation indicators are available for easy visual confirmation that relays are operating. They simplify maintenance.

4. UL/CSA approved

5. Wide range of sockets and terminal sockets

To enable use with DIN rails, DIN terminal sockets are also available.

TYPICAL APPLICATIONS

HP relays enjoy wide use in various applications, particularly in automation controls and remote controls.

Applications include:

1. Industrial machinery

For controlling positioning, pressure, and temperature in molding equipment, boilers, pumps, charging pressure equipment, measuring and evaluation equipment, textile machines, etc.

2. Machine tools

Control of positioning and directional change in turning machines, lathes, borers, etc.

3. Food processing packing machines

Automatic control of packing equipment for milk and seafood, bottling, canning, and packaging

4. Office equipment

Control of copiers, time recorders, etc.

5. Coin operate machines

Control of food, cigarette, and other vending machines

6. Transportation

Amplification of control signals in control devices for vehicles and vessels, functional parts of all kinds of equipment, control signal repeating installation in signaling devices and equipment.

7. Measuring devices and equipment

For repeating installation of control signals and in power amplifiers

8. Generators, transformers and power receiving equipment.

Functional parts in protective equipment, functional assistance in automatic adjustment equipment, telemeters and other remote monitoring equipment

9. Control of conveyance equipment

Control panels for elevators, escalators, and other conveyance equipment, control of all kinds industrial transport equipment such as conveyors.

10. Amusement equipment

Control of equipment in amusement parks, etc., control of bowling alley equipment, control of fountains in public parks

About Cd-free contacts

We have introduced Cadmium free type products to reduce Environmental Hazardous Substances. (The suffix "F" should be added to the part number. The Suffix "F" is required only for 4 Form C contact type. The 2 Form C and 3 Form C contact type is originally cadmium-free, the suffix "F" is not required.)

Please replace parts containing Cadmium with Cadmium-free products and evaluate them with your actual application before use because the life of a relay depends on the contact material and load.

ORDERING INFORMATION



Contact arrangement

- 2: 2 Form C
- 3: 3 Form C
- 4: 4 Form C

Terminal arrangement

- Nil: Standard plug-in terminal
- TM: TM type (2 Form C only)
- M: Direct mounting (3 Form C only)

Operation indication

- Nil: Without indication
- L: With indication

Coil voltage

- AC 6, 12, 24, 48, 100, (115), 200, (220), (240) V
- DC 6, 12, 24, 48, 100, (110) V

Contact material

- F: 4 Form C, Silver alloy (cadmium-free)
- Nil: 2 Form C, 3 Form C (Silver)

With LED indicator type









Coil voltage: 6, 12, 24 V AC 6, 12, 24, 48 V DC

With neon lamp type

Coil voltage: 100, 115, 200, 220, 240 V AC 100, 110 V DC

TYPES













1. Plug-in type

Coil voltage	2 Form C		3 Form C		4 Form C	
		Part No.		Part No.		Part No.
6V AC		HP2-AC6V		HP3-AC6V		HP4-AC6V-F
12V AC		HP2-AC12V		HP3-AC12V		HP4-AC12V-F
24V AC		HP2-AC24V		HP3-AC24V		HP4-AC24V-F
48V AC		HP2-AC48V		HP3-AC48V		HP4-AC48V-F
100V AC		HP2-AC100V		HP3-AC100V		HP4-AC100V-F
115V AC		HP2-AC115V		HP3-AC115V		HP4-AC115V-F
200V AC		HP2-AC200V		HP3-AC200V		HP4-AC200V-F
220V AC		HP2-AC220V		HP3-AC220V		HP4-AC220V-F
240V AC		HP2-AC240V		HP3-AC240V		HP4-AC240V-F
6V DC		HP2-DC6V		HP3-DC6V		HP4-DC6V-F
12V DC		HP2-DC12V		HP3-DC12V		HP4-DC12V-F
24V DC		HP2-DC24V		HP3-DC24V		HP4-DC24V-F
48V DC		HP2-DC48V		HP3-DC48V		HP4-DC48V-F
100V DC		HP2-DC100V		HP3-DC100V		HP4-DC100V-F
110V DC		HP2-DC110V		HP3-DC110V		HP4-DC110V-F

Standard packing (2 Form C): Carton: 20 pcs.; Case: 100 pcs.

Standard packing (3 Form C, 4 Form C): Carton: 10 pcs.; Case: 50 pcs.









2. Plug-in type (with LED indication)

	Coil voltage	2 Form C		3 Form C		4 Form C	
			Part No.		Part No.		Part No.
With LED indication	6V AC		HP2-L-AC6V		HP3-L-AC6V		HP4-L-AC6V-F
	12V AC		HP2-L-AC12V		HP3-L-AC12V		HP4-L-AC12V-F
	24V AC		HP2-L-AC24V		HP3-L-AC24V		HP4-L-AC24V-F
With neon lamp	100V AC		HP2-L-AC100V		HP3-L-AC100V		HP4-L-AC100V-F
	115V AC		HP2-L-AC115V		HP3-L-AC115V		HP4-L-AC115V-F
	200V AC		HP2-L-AC200V		HP3-L-AC200V		HP4-L-AC200V-F
	220V AC		HP2-L-AC220V		HP3-L-AC220V		HP4-L-AC220V-F
	240V AC		HP2-L-AC240V		HP3-L-AC240V		HP4-L-AC240V-F
With LED indication	6V DC		HP2-L-DC6V		HP3-L-DC6V		HP4-L-DC6V-F
	12V DC		HP2-L-DC12V		HP3-L-DC12V		HP4-L-DC12V-F
	24V DC		HP2-L-DC24V		HP3-L-DC24V		HP4-L-DC24V-F
	48V DC		HP2-L-DC48V		HP3-L-DC48V		HP4-L-DC48V-F
With neon lamp	100V DC		HP2-L-DC100V		HP3-L-DC100V		HP4-L-DC100V-F
	110V DC		HP2-L-DC110V		HP3-L-DC110V		HP4-L-DC110V-F

Standard packing (2 Form C): Carton: 20 pcs.; Case: 100 pcs.

Standard packing (3 Form C, 4 Form C): Carton: 10 pcs.; Case: 50 pcs.

3. TM type and Direct mount type

Coil voltage	2 Form C (TM type)		3 Form C (direct mount type)	
		Part No.		Part No.
6V AC		HP2-TM-AC6V		HP3-M-AC6V
12V AC		HP2-TM-AC12V		HP3-M-AC12V
24V AC		HP2-TM-AC24V		HP3-M-AC24V
48V AC		HP2-TM-AC48V		HP3-M-AC48V
100V AC		HP2-TM-AC100V		HP3-M-AC100V
115V AC		HP2-TM-AC115V		HP3-M-AC115V
200V AC		HP2-TM-AC200V		HP3-M-AC200V
220V AC		HP2-TM-AC220V		HP3-M-AC220V
240V AC		HP2-TM-AC240V		HP3-M-AC240V
6V DC		HP2-TM-DC6V		HP3-M-DC6V
12V DC		HP2-TM-DC12V		HP3-M-DC12V
24V DC		HP2-TM-DC24V		HP3-M-DC24V
48V DC		HP2-TM-DC48V		HP3-M-DC48V
100V DC		HP2-TM-DC100V		HP3-M-DC100V
110V DC		HP2-TM-DC110V		HP3-M-DC110V

Standard packing: Carton: 10 pcs.; Case: 50 pcs.

4. Direct mount type (with LED indication)

	Coil voltage	3 Form C	
			Part No.
With neon lamp	100V AC		HP3-ML-AC100V
	115V AC		HP3-ML-AC115V
	200V AC		HP3-ML-AC200V
	220V AC		HP3-ML-AC220V
	240V AC		HP3-ML-AC240V
	100V DC		HP3-ML-DC100V
	110V DC		HP3-ML-DC110V

Standard packing: Carton: 10 pcs.; Case: 50 pcs.

Notes: 1. Standard packaging is handled in units of inner cartons. Please specify if you require inner cartons to be boxed.







2. Sockets, terminal sockets and installation brackets are not included. Please order these separately.

3. For products compliant with international standards, please refer to the standards chart.



RATING

1. Coil data

1) AC coils

Contact arrangement	Nominal coil voltage	Nominal coil current (mA)		Nominal operating power (VA)		Inductance (H)		Pick-up voltage (at 20°C 68°F)	Drop-out voltage (at 20°C 68°F)	Max. allowable voltage (at 20°C 68°F)
		50Hz	60Hz	50Hz	60Hz	50Hz	60Hz			
2 Form C	 6V AC	349mA	310mA	2.09VA	1.9VA	0.051	0.049	80%V or less of nominal voltage (Initial)	30%V or more of nominal voltage (Initial)	110%V of nominal voltage
	 12V AC	181.2mA	160mA	2.17VA	1.9VA	0.198	0.190			
	24V AC	94mA	78mA	2.25VA	1.9VA	0.753	0.776			
	48V AC	46.5mA	39mA	2.23VA	1.9VA	3.055	3.106			
	100V AC	25.3mA	21mA	2.36VA	2.1VA	12.60	12.03			
	115V AC	23.1mA	18mA	2.31VA	2.1VA	16.70	15.83			
	200V AC	12.4mA	11mA	2.48VA	2.2VA	48.03	45.81			
	220V AC	10.6mA	9.5mA	2.34VA	2.1VA	61.28	57.90			
240V AC	10.0mA	9.0mA	2.40VA	2.2VA	69.00	66.26				
3 Form C	 6V AC	594mA	520mA	3.56VA	3.1VA	0.03	0.030	80%V or less of nominal voltage (Initial)	30%V or more of nominal voltage (Initial)	110%V of nominal voltage
	 12V AC	297mA	260mA	3.56VA	3.1VA	0.123	0.119			
	24V AC	148.7mA	130mA	3.56VA	3.1VA	0.0494	0.475			
	48V AC	74.2mA	65mA	3.56VA	3.1VA	1.976	1.899			
	100V AC	36.4mA	32mA	3.64VA	3.2VA	8.500	8.038			
	115V AC	32.5mA	28.5mA	3.74VA	3.3VA	10.79	10.36			
	200V AC	18.2mA	16mA	3.65VA	3.2VA	33.53	32.10			
	220V AC	16.0mA	14.2mA	3.54VA	3.1VA	41.35	39.32			
240V AC	15.8mA	13.9mA	3.79VA	3.3VA	45.94	44.05				
4 Form C	 6V AC	909mA	800mA	5.46VA	4.8VA	0.020	0.019	80%V or less of nominal voltage (Initial)	30%V or more of nominal voltage (Initial)	110%V of nominal voltage
	 12V AC	456mA	400mA	5.47VA	4.8VA	0.080	0.077			
	24V AC	229mA	200mA	5.49VA	4.8VA	0.320	0.309			
	48V AC	108mA	95mA	5.18VA	4.6VA	1.348	1.292			
	100V AC	57.3mA	50mA	5.73VA	5.0VA	5.348	5.156			
	115V AC	47.6mA	42mA	5.47VA	4.8VA	7.264	6.953			
	200V AC	28.5mA	25mA	5.69VA	5.0VA	21.27	20.45			
	220V AC	23.8mA	21mA	5.24VA	4.6VA	27.75	26.57			
240V AC	23.3mA	20.5mA	5.58VA	4.9VA	30.98	29.75				

2) DC coils (20°C 68°F)

Contact arrangement	Nominal coil voltage	Nominal coil current (mA)	Nominal operating power (W)	Coil resistance (Ω)	Pick-up voltage (at 20°C 68°F)	Drop-out voltage (at 20°C 68°F)	Max. allowable voltage (at 20°C 68°F)
2 Form C	 6V DC	240mA	1.5W	25Ω	80%V or less of nominal voltage (Initial)	15%V or more of nominal voltage (Initial)	110%V of nominal voltage
	12V DC	109mA	1.3W	110Ω			
	24V DC	54.5mA	1.3W	440Ω			
	48V DC	26.7mA	1.3W	1,800Ω			
	100V DC	14.9mA	1.5W	6,700Ω			
	110V DC	15.0mA	1.7W	7,300Ω			
3 Form C	 6V DC	250mA	1.5W	24Ω	80%V or less of nominal voltage (Initial)	15%V or more of nominal voltage (Initial)	110%V of nominal voltage
	12V DC	120mA	1.4W	100Ω			
	24V DC	60mA	1.4W	400Ω			
	48V DC	31mA	1.5W	1,560Ω			
	100V DC	15.6mA	1.6W	6,400Ω			
	110V DC	14.9mA	1.6W	7,450Ω			
4 Form C	 6V DC	273mA	1.6W	22Ω	80%V or less of nominal voltage (Initial)	15%V or more of nominal voltage (Initial)	110%V of nominal voltage
	12V DC	127mA	1.5W	95Ω			
	24V DC	63mA	1.5W	380Ω			
	48V DC	32.0mA	1.5W	1,500Ω			
	100V DC	16.3mA	1.6W	5,950Ω			
	110V DC	15.7mA	1.7W	7,000Ω			

Notes: 1. The rated current area is ±15% (60Hz) [AC coils], ±10% (20°C) [DC coils]

2. The coil resistance for DC operation is the value measured when the coil temperature is 20°C 68°F. Compensate ±0.4% for every ±1°C change in temperature.

3. The relay operates in a range of 80% to 110% V of the voltage rating, but ideally, in consideration of temporary voltage fluctuations, it should be operated at the rated voltage. In particular, for AC operation, if the impressed voltage drops to 80% V or more below the rated voltage, humming will occur and a large current will flow leading possibly to coil burnout.

4. For use with 200 V DC, connect a 6.7kΩ (10W) resistor, in series, to the 100 V DC relay [3 Form C type is .6.4kΩ (5W); 4 Form C type is .6.2kΩ (10W)].

5. As a general rule, only a pure DC voltage should be used for the coil drive.

However, a DC power supply that contains ripples has characteristics that differ from pure DC.

Therefore, please verify characteristics (operate voltage, release voltage, humming) using the actual circuit that will be used.

2. Specifications

Characteristics	Item	Specifications	
Contact	Arrangement	2 Form C, 3 Form C, 4 Form C	
	Initial contact resistance, max	Max. 15 mΩ (By voltage drop 6 V DC 1A)	
	Contact material	2 Form C, 3 Form C 4 Form C Ag Ag alloy (cd free)	
Rating	Nominal switching capacity	10A 250V AC (resistive load)	
	Min. switching capacity (Reference value)*1	100mA 5V DC	
Electrical characteristics	Insulation resistance (Initial)	Min. 100MΩ (at 500V DC) Measurement at same location as "Initial breakdown voltage" section.	
	Breakdown voltage (Initial)	Between open contacts	1,000 Vrms for 1min (2 Form C, 4 Form C). 2,000 Vrms for 1min (3 Form C) (Detection current: 10mA.)
		Between contact sets	1,500 Vrms for 1min (2 Form C, 4 Form C). 2,000 Vrms for 1min (3 Form C) (Detection current: 10mA.)
		Between contact and coil	1,500 Vrms for 1min (2 Form C, 4 Form C). 2,000 Vrms for 1min (3 Form C) (Detection current: 10mA.)
	Temperature rise	Max. 65°C (By temperature method, at 40°C, nominal current)	
	Operate time*2	Max. 25ms (2 Form C), Max.30ms (3 Form C, 4 Form C) (Nominal voltage applied to the coil, excluding contact bounce time.)	
Release time*2	Max. 25ms (2 Form C), Max.30ms (3 Form C, 4 Form C) (Nominal voltage applied to the coil, excluding contact bounce time.) (without diode)		
Mechanical characteristics	Shock resistance	Functional	Min. 98 m/s ² (Half-wave pulse of sine wave: 11 ms; detection time: 10μs.)
		Destructive	Min. 980 m/s ² (Half-wave pulse of sine wave: 6 ms.)
	Vibration resistance	Functional	10 to 55 Hz at double amplitude of 1 mm (Detection time: 10μs.)
		Destructive	10 to 55 Hz at double amplitude of 2 mm
Expected life	Mechanical	Min. 10 ⁷	
Conditions	Conditions for operation, transport and storage*3	Ambient temperature: -50°C to +40°C -58°F to +104°F Humidity: 5 to 85% R.H. (Not freezing and condensing at low temperature)	
	Max. Operating speed	20 cpm (at max. rating)	
Unit weight		2 Form C: approx. 60g 2.12oz, 3 Form C: approx. 100g 3.53oz, 4 Form C: approx. 125g 4.41oz	

Notes: *1 This value can change due to the switching frequency, environmental conditions and desired reliability level, therefore it is recommended to check this with the actual load.

*2 For the AC coil types, the operate/release time will differ depending on the phase.

*3 The upper operation ambient temperature limit is the maximum temperature that can satisfy the coil temperature rise value. Refer to 6. Conditions for operation, transport and storage mentioned in AMBIENT ENVIRONMENT.

3. Electrical life

1) AC load

Voltage	125V AC		250V AC		Expected life
	Resistive (A) (cosφ=1)	Inductive (A) (cosφ=0.4)	Resistive (A) (cosφ=1)	Inductive (A) (cosφ=0.4)	
Current	—	—	10	7.5	Min. 2×10 ⁵
	10	7.5	7.5	5	Min. 5×10 ⁵
	5	3	3	2	Min. 10 ⁶
	1	0.7	0.6	0.4	Min. 2×10 ⁶

Note: When the electromagnet or exciting coil (Solenoid, etc.) is the load, the value of motor or lamp load is applicable.

2) DC load

Voltage	24V DC		125V DC		Expected life
	Resistive (A)	Inductive (A)	Resistive (A)	Inductive (A)	
Current	—	7	—	—	Min. 2×10 ⁵
	7.5	5	0.5	0.4	Min. 5×10 ⁵
	5	3	0.3	0.2	Min. 10 ⁶
	1	0.6	0.1	0.06	Min. 2×10 ⁶

Note: For DC inductive loads, use an arc suppressing circuit.

Note: Cautions at DC load use

When used under a DC load operating at high repetition rate with considerable arcing, corrosion of the contacts and/or the contact blades is likely to occur.

4. Life of LED and neon lamp (with operation indication)

	Continuous	Use rating (ON time) 50%
With neon lamp	25,000 hours (approx. 3 years)	Approx. 6 years
With LED indication	50,000 hours (approx. 5.5 years)	100,000 hours (approx. 11 years)

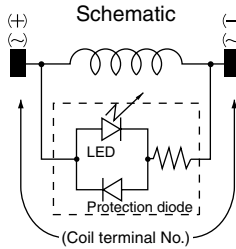
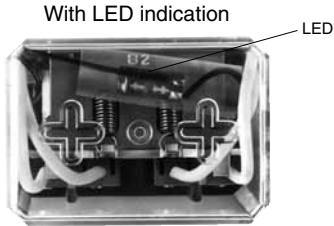
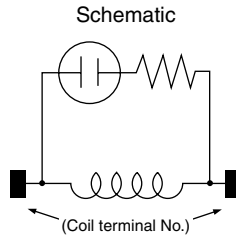
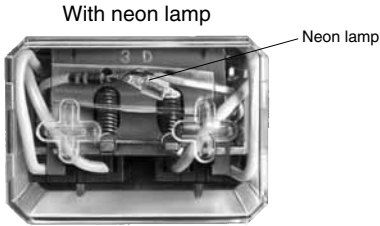

Coil terminal No. and polarity (DC type)

	Polarity	HP2	HP3	HP4
Terminal No.	(+)	7	10	10
	(-)	2	2	1

REFERENCE DATA

1. Life curve

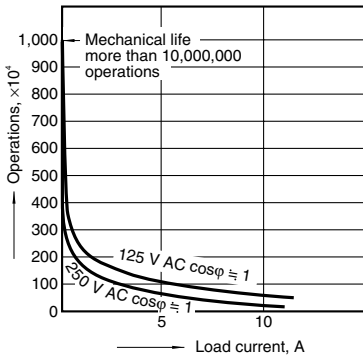

2. Max. switching capacity

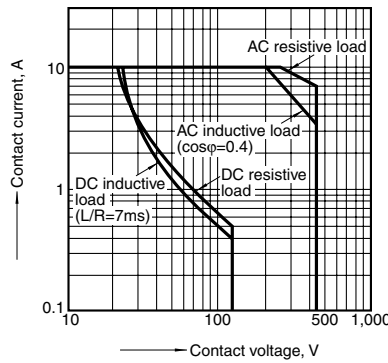

DIMENSIONS (Unit: mm inch)

Plug-in type (2 Form C)



External dimensions

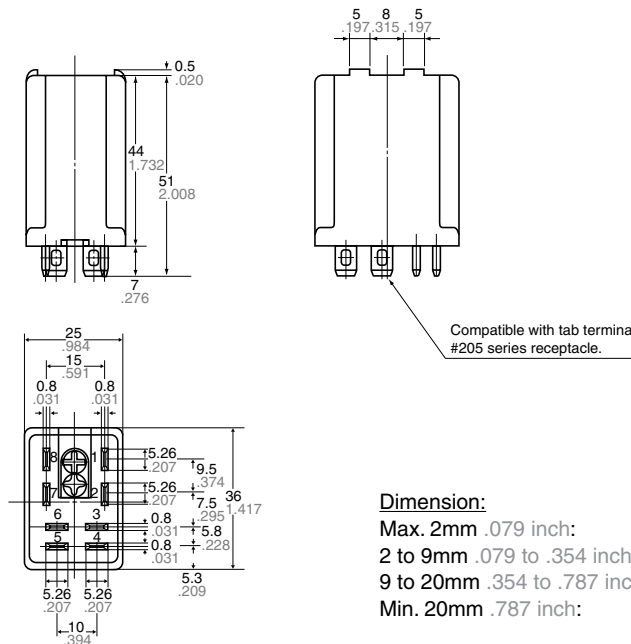

Schematic (Bottom view)

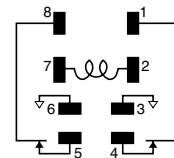

Dimension:	Tolerance
Max. 2mm .079 inch:	±0.2 ±.008
2 to 9mm .079 to .354 inch:	±0.5 ±.020
9 to 20mm .354 to .787 inch:	±1 ±.039
Min. 20mm .787 inch:	±1.5 ±.059

Plug-in type (3 Form C)

External dimensions

Schematic (Bottom view)

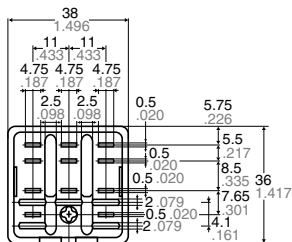
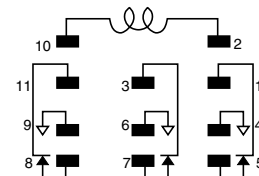
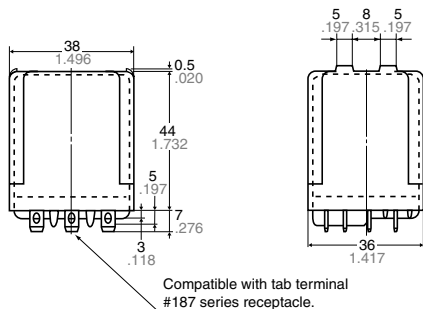

<u>Dimension:</u>	<u>Tolerance</u>
Max. 2mm .079 inch:	$\pm 0.2 \pm 0.08$
2 to 9mm .079 to .354 inch:	$\pm 0.5 \pm 0.20$
9 to 20mm .354 to .787 inch:	$\pm 1 \pm 0.39$
Min. 20mm .787 inch:	$\pm 1.5 \pm 0.59$

Plug-in type (4 Form C)

External dimensions

Schematic (Bottom view)

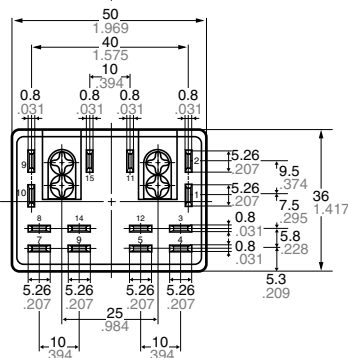
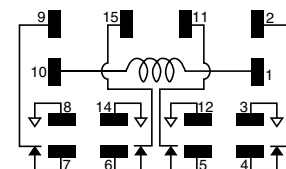
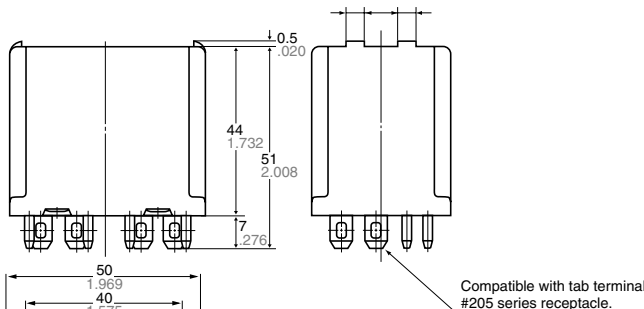

<u>Dimension:</u>	<u>Tolerance</u>
Max. 2mm .079 inch:	$\pm 0.2 \pm 0.08$
2 to 9mm .079 to .354 inch:	$\pm 0.5 \pm 0.20$
9 to 20mm .354 to .787 inch:	$\pm 1 \pm 0.39$
Min. 20mm .787 inch:	$\pm 1.5 \pm 0.59$

**TM type
(2 Form C)**



Dimension:
 Max. 2mm .079 inch: $\pm 0.2 \pm .008$
 2 to 9mm .079 to .354 inch: $\pm 0.5 \pm .020$
 9 to 20mm .354 to .787 inch: $\pm 1 \pm .039$
 Min. 20mm .787 inch: $\pm 1.5 \pm .059$

Tolerance
 $\pm 0.2 \pm .008$
 $\pm 0.5 \pm .020$
 $\pm 1 \pm .039$
 $\pm 1.5 \pm .059$

External dimensions

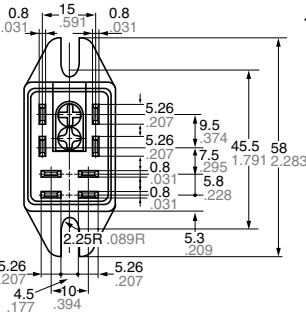
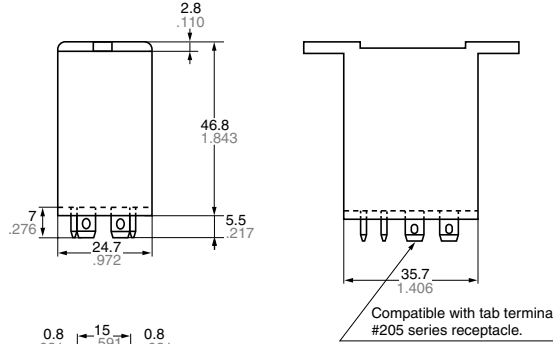

Schematic (Bottom view)

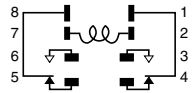

Mounting hole diagram

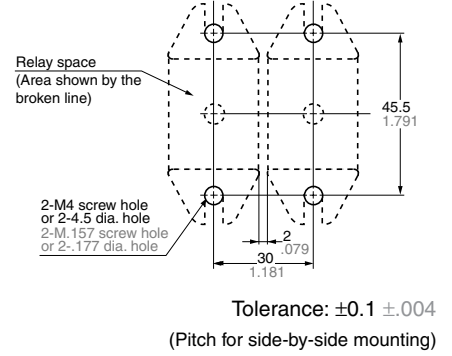

Installed relay

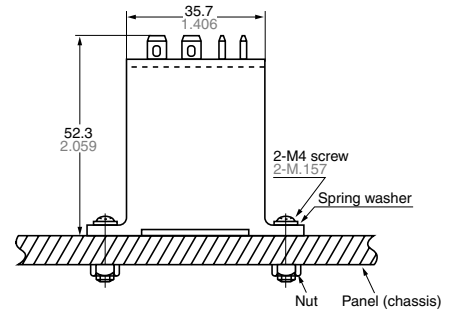

**Direct mounting type
(3 Form C)**



Dimension:
 Max. 2mm .079 inch: $\pm 0.2 \pm .008$
 2 to 9mm .079 to .354 inch: $\pm 0.5 \pm .020$
 9 to 20mm .354 to .787 inch: $\pm 1 \pm .039$
 Min. 20mm .787 inch: $\pm 1.5 \pm .059$

Tolerance
 $\pm 0.2 \pm .008$
 $\pm 0.5 \pm .020$
 $\pm 1 \pm .039$
 $\pm 1.5 \pm .059$

External dimensions

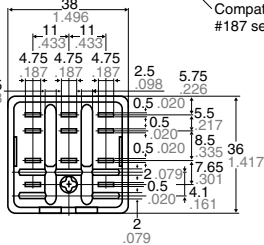
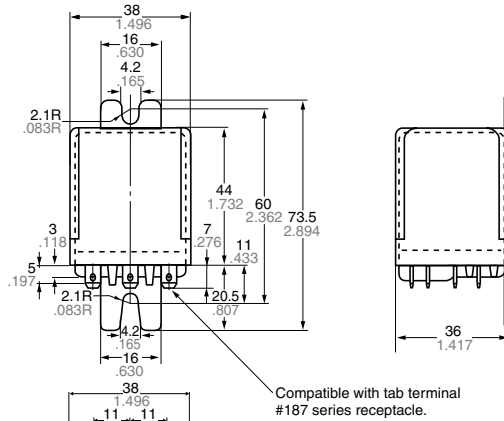

Schematic (Bottom view)

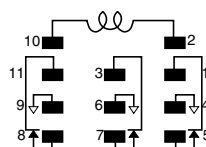

Mounting hole diagram

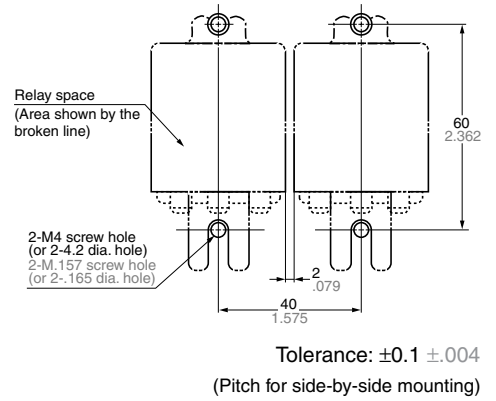

Installed relay

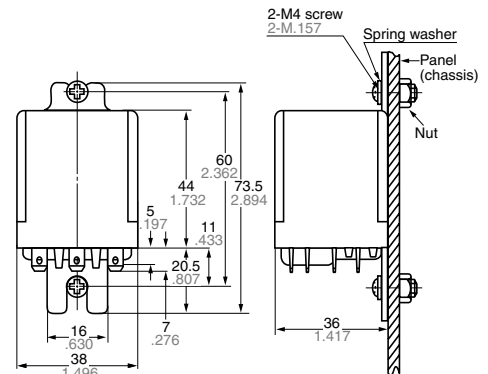

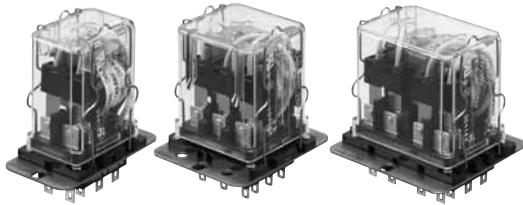

Socket for rectangular hold boring

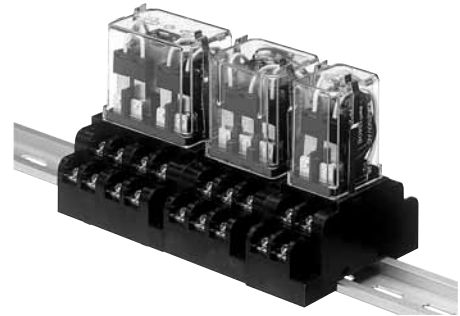

Terminal socket for DIN rail assembly

RoHS Directive compatibility information
<http://www.mew.co.jp/ac/e/environment/>

TYPES

1. For DIN rail terminal sockets, hold-down clip included.
2. For square hole sockets, powerful hold-down clip included.

Type	No. of poles	Item	Part No.	Packing quantity	
				Carton	Case
Square hole socket	2-pole	HP2-square hole socket	HP2-SRS	20 pcs.	100 pcs.
	3-pole	HP3-square hole socket	HP3-SRS	10 pcs.	50 pcs.
	4-pole	HP4-square hole socket	HP4-SRS	10 pcs.	50 pcs.
DIN rail terminal socket	2-pole	HP2-DIN terminal socket	HP2-SFD	10 pcs.	50 pcs.
	3-pole	HP3-DIN terminal socket	HP3-SFD	10 pcs.	50 pcs.
	4-pole	HP4-DIN terminal socket	HP4-SFD	5 pcs.	25 pcs.
Common part	2/3/4-pole (common)	HP-hold down clip for socket	AW5806	—	50 pcs.

Note: Socket and terminal socket conform to UL, CSA as standard.

HP RELAY ACCESSORIES

DIMENSIONS (Unit: mm inch)

1. Socket for rectangular hold boring (hold-down clip included)

HP2-Socket (HP2-SRS)



Front surface mounting

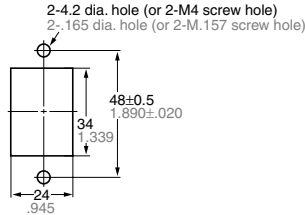

When the socket is mounted from the top of the panel (chassis).

Tolerance: $\pm 0.1 \pm .004$

Mounting dimensions

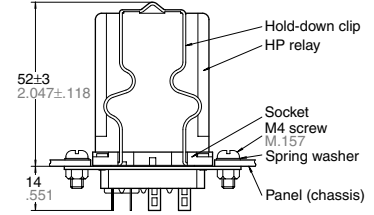

External dimensions

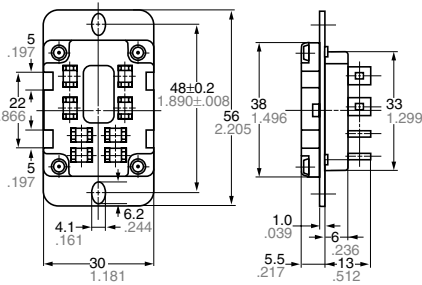

General tolerance: $\pm 0.1 \pm .004$

Rear surface mounting

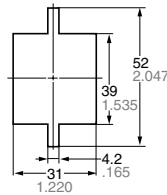

When the socket is mounted from below the panel (chassis).

Tolerance: $\pm 0.1 \pm .004$

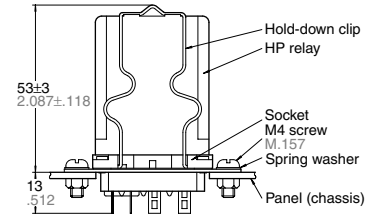

- Notes: 1. Optimum space-saving panel cut-out.
2. Can be mounted from either the front or the rear of the panel.
3. Hold-down clip is included in package.

HP3-Socket (HP3-SRS)



Front surface mounting

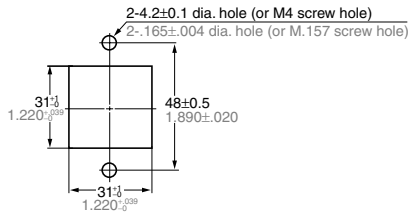

Tolerance: $\pm 0.1 \pm .004$

Mounting dimensions

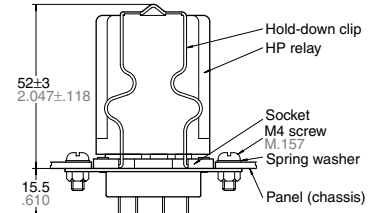

External dimensions

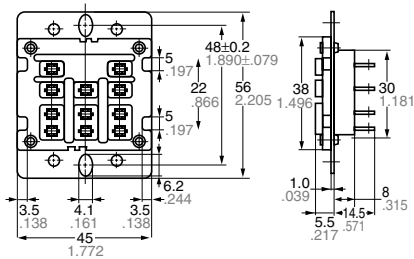

General tolerance: $\pm 0.1 \pm .004$

Rear surface mounting

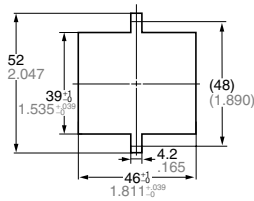

Tolerance: $\pm 0.1 \pm .004$

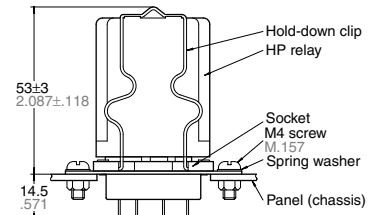

- Notes: 1. Optimum space-saving panel cut-out.
2. Can be mounted from either the front or the rear of the panel.
3. Hold-down clip is included in package.

HP RELAY ACCESSORIES

HP4-Socket (HP4-SRS)



Front surface mounting

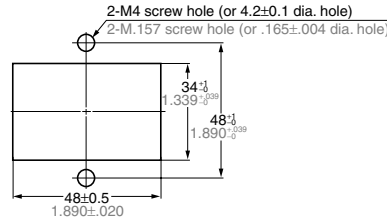

Tolerance: $\pm 0.1 \pm .004$

Mounting dimensions

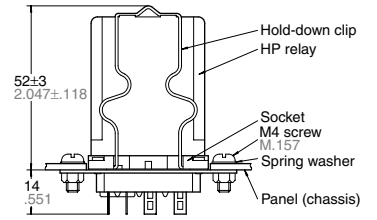

External dimensions

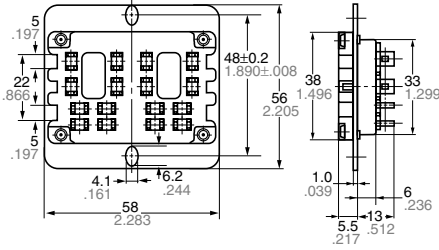

General tolerance: $\pm 0.1 \pm .004$

Rear surface mounting

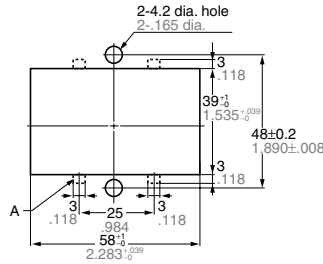

Tolerance: $\pm 0.1 \pm .004$

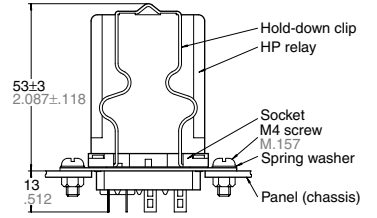

- Notes:
1. Optimum space-saving panel cut-out.
 2. Can be mounted from either the front or the rear of the panel.
 3. Hold-down clip is included in package.

* When using the former hold-down clip, it is necessary to cut out the A section marked by the broken line (not necessary with the powerful hold-down clip).

2. Terminal socket for DIN rail assembly (hold-down clip and installation screw included)

HP2-Terminal socket for DIN rail assembly (HP2-SFD)



External dimensions

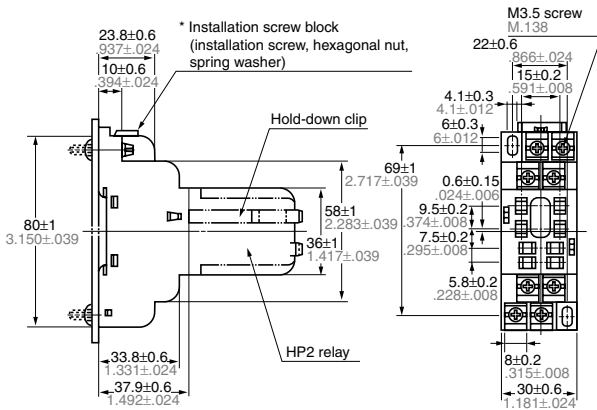

Schematic

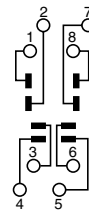

Mounting hole diagram

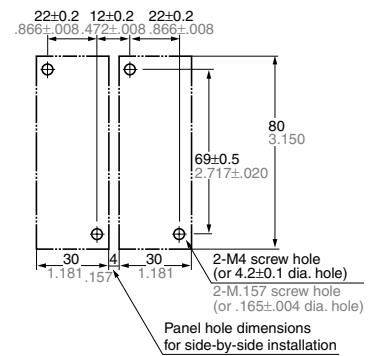

- Notes:
1. For direct mounting, use the included installation screw block.
 2. A hold-down clip is included with the terminal socket.

HP RELAY ACCESSORIES

HP3-Terminal socket for DIN rail assembly (HP3-SFD)

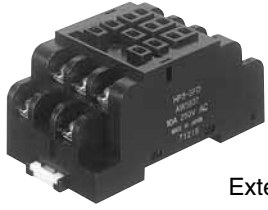

External dimensions

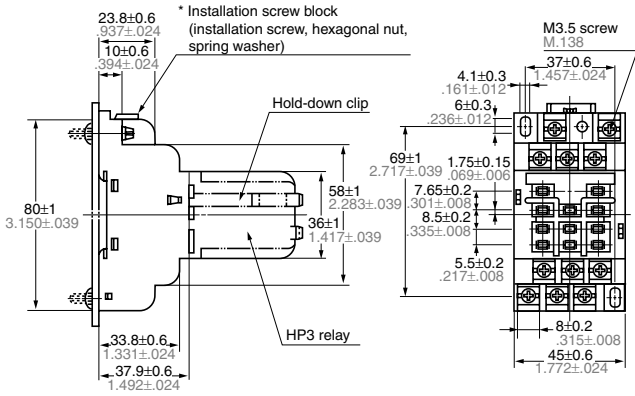

Schematic

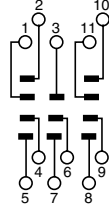

Mounting hole diagram

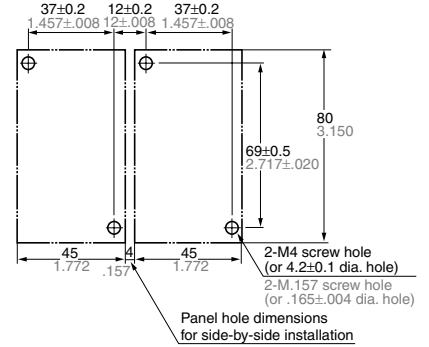

- Notes: 1. For direct mounting, use the included installation screw block.
2. A hold-down clip is included with the terminal socket.

HP4-Terminal socket for DIN rail assembly (HP4-SFD)

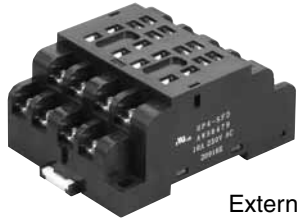

External dimensions

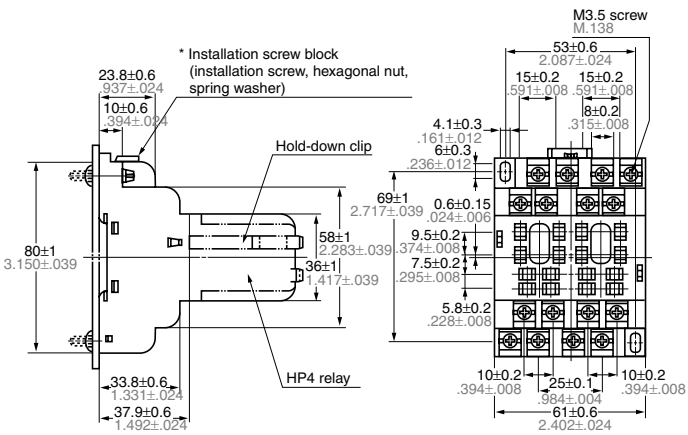

Schematic

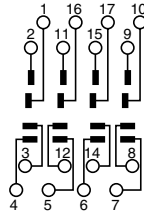

Mounting hole diagram

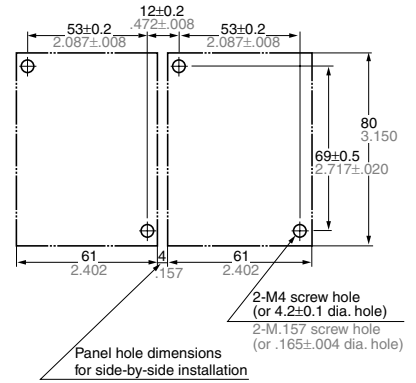

- Notes: 1. For direct mounting, use the included installation screw block.
2. A hold-down clip is included with the terminal socket.

NOTES

1. There are two types of HP relay: plug-in and direct mounting (HP2-TM and HP3-M only).

Avoid use of direct mounting types in sockets or terminal sockets.

Note: Mounting measurements for direct mounting types (HP2-TM and HP3-M) are shown in the drawing on page 146.

2. The terminals are compatible with tab terminals. Consequently, for direct mounting types, in addition to soldering, AMP terminals can be used.

Part number	Compatible tab terminal
HP2	#205 series
HP3	#187 series
HP4	#205 series

3. When tightening the fixing screws of direct mounting types, use washers to prevent damage or distortion. The optimum torque range is 0.49 to 0.69 N·m, (5 to 7 kgf·cm).

To prevent loosening of direct mounting types, terminal sockets and sockets, etc., when fixing the screws, use spring washers, etc. Moreover, wiring (soldering), should be done with care while ensuring strong connections.

4. When tightening terminal socket fixing screws, to prevent damage, the optimum torque range should be 0.784 to 0.98 N·m, (8 to 10 kgf·cm).

5. Avoid use in adverse conditions, such as where the relay will be subjected to strong vibrations or shock, where there is exposure to harmful gas, or where ambient temperatures are high (more than 40°C).

6. Use in DC load
Abnormal wear of the contacts and contact springs will occur when the switching frequency is high and there are large arcs. In particular, if high-frequency operation in hot or humid conditions is intended, use arc-suppressing circuits.

7. There is no particular specification for HP relay mounting orientation.

8. Do not insert or remove relays into or out of live circuits.

For Cautions for Use, see Relay Technical Information.