



CATALOGUE

HDMI Connector



Range Overview

Receptacle to Overmolded with Cable

Rectangle Type

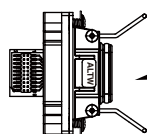

Receptacle

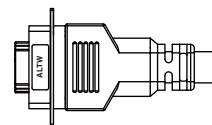

Overmolded with Cable

Circular Type

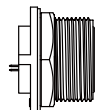

Receptacle

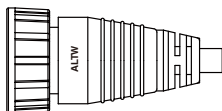

Overmolded with Cable

Accessories

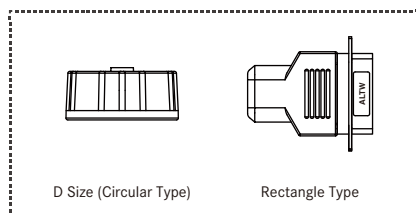

D Size (Circular Type)

Rectangle Type

Specification

Identifications	HDMI connector
Description	Receptacle Overmolded with Cable
Current Rating / Data	0.5A
Material	Contacts: Phospor Bronze Connector Body (Housing): PBT Shell: Brass
Waterproof Rating	IP67 (Mated Waterproof)
Temperature Range	Receptacle: -20°C~80°C Overmolded with Cable: -20°C~80°C
Contact Resistance	≤ 20 mΩ
Insulation Resistance	≥ 100 mΩ at DC500V
More to know	Standard Cable Length: 01~05M

Ordering Information

	1	2	3	4	5	6	7	8	9	10
Specification										
(HJ) HDMI Jack										
(HP) HDMI Plug										
Number of Contacts										
(19) 19 Contacts										
Connector Body (Style)										
> For Receptacle										
(P) Front Fastened										
> For Overmolded with Cable										
(A) With Strain Relief										
Connector (Housing) Gender										
(M) Male (Plug)										
(F) Female (Jack)										
Contact Gender										
(M) Male (Stamp)										
(F) Female (Stamp)										
Assemble Style										
> For Receptacle										
(R) 90° PCB Type										
> For Overmolded with Cable										
(P) 180° PCB Type										
(M) Overmolded with Cable										
Mating Style										
(Q) Latch										
(S) Screw Thread										
Backshell										
> For Receptacle										
(S) Rectangle										
> For Overmolded with Cable										
(C) Circular										
(L) Straight										
Waterproof Rating										
(7) IP 67										
More information										
> For Receptacle										
(001), (002).....										
Without Cable : Different										
Versions										
> For Overmolded with Cable										
(□)+(■) : Cable Type + Cable Length										
e.g. (A01) = UL20276 Cable + 1M										
□ : Cable Type										
■ : Cable Length										
(A) UL20276 Cable From 1M to 5M										
e.g. (01) = 1M										

【Note】 Design and specification are subject to change without notice.

Physical Dimension

Receptacle

Panel Cut-Out
 Rectangle Type

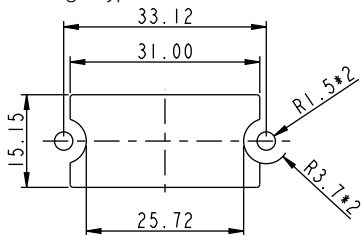

Connector Dimension

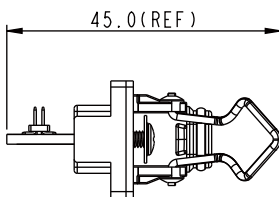

Connector Dimension

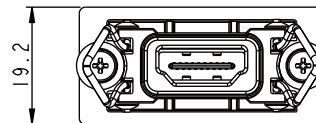

Circular Type

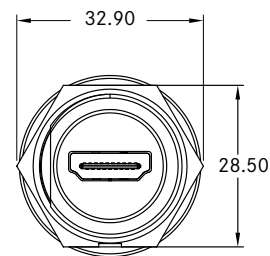
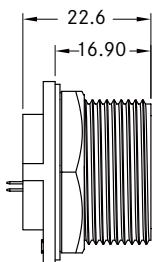
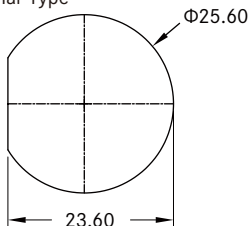

* Unit: mm

Overmolded with Cable

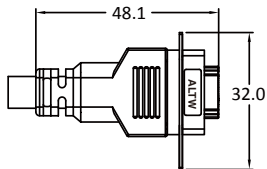

Rectangle Type

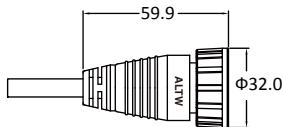

Circular Type

* Unit: mm

Contact Configuration

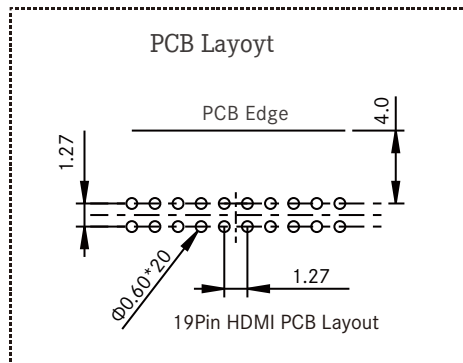
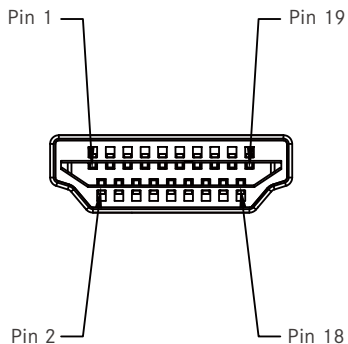

* Unit: mm

[Note] This only shows contact configuration of Jack as your reference.

Product Features

Receptacle

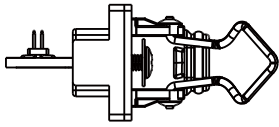

Rectangle Type

Mating Style 7

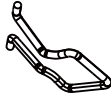

Latch (Q)

Connector Body(Style) 3

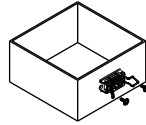

Front Fastened (P)

Backshell 8



Rectangle (S)

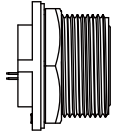

Circular Type

Mating Style 7



Screw Thread (S)

Connector Body(Style) 3

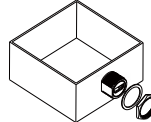

Front Fastened (P)

Backshell 8



Circular (C)

Overmolded with Cable

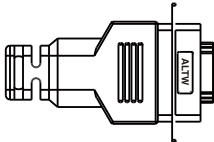

Rectangle Type

Mating Style 7

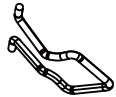

Latch (Q)

Connector Body(Style) 3

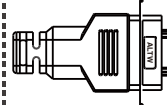

With Strain Relief (A)

Backshell 8

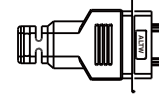

Straight (L)

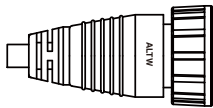

Circular Type

Mating Style 7



Screw Thread (S)

Connector Body(Style) 3



With Strain Relief (A)

Backshell 8



Straight (L)

【Note】 Design and specification are subject to change without notice.

Find Our Standard Products

Receptacle and Mating Pair

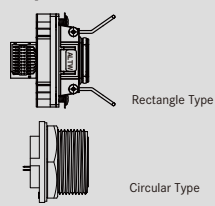
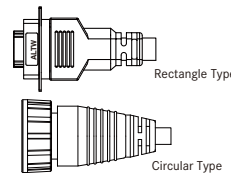
<ul style="list-style-type: none"> • Female Connector (Housing) • Female Contacts • Latch • Screw Thread 	Receptacle → 	Overmolded with Cable 	Field Installable
Connector Style	Female Connector (F) Female Contacts (F)	Male Connector (M) Male Contacts (M)	Male Connector (M) Male Contacts (M)
Rectangle Type	HJ-19PFFR-QS7001	HP-19AMMM-QL7A XX *	-
Circular Type	HJ-19PMFP-SC7001	HP-19AFMM-SL7A XX *	-

* **XX**: Choose UL20276 cable and select the cable length from 01~05m

Accessories

Waterproof Cap

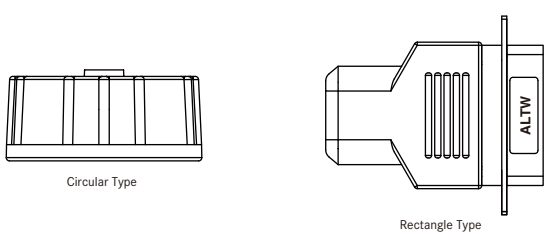
				
Size	Mating Pair	Mating Style	Mating Pair (Gender)	P/N
D Size (Circular Type)	Receptacle	Screw Thread	Male	CAP-WADMSMA 1
Rectangle Type	Receptacle	Latch Type	Female	CAP-WHDFLPA 1

Amphenol LTW Technology Co., Ltd.

5F-3, No.51, Sec.4, Zhongyang Rd., Tucheng Dist., New Taipei City 236, Taiwan
Telephone: +886-2-77416888 Fax: +886-2-77416999
www.amphenolltw.com

Kunshan Factory

No. 62, DaTong Road, Development Zone, Kunshan City, JiangSu Province, 215333 China
Telephone: +86-512-5761-0501
Fax: : +86-512-5761-0515

For further information, please contact :

Sales & Marketing Department | Email : sales@ltw-tech.com