

# NMEA 2000 Connector

## Range Overview

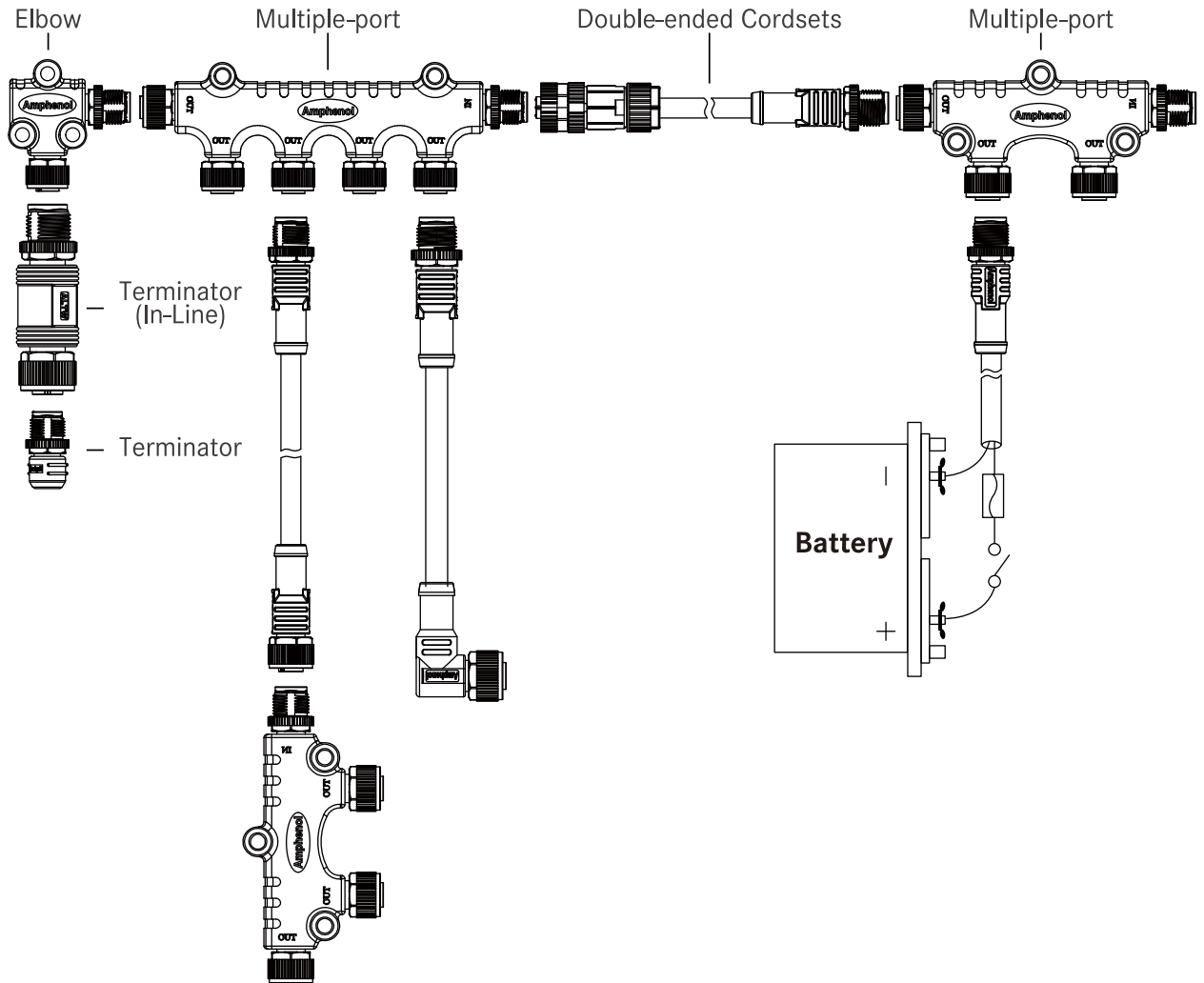

### About NMEA 2000

Amphenol LTW Technology expands its coverage targeting the marine industry that features the NMEA 2000 standard.

The NMEA 2000 standard contains the requirements of a serial data communications network to inter-connect marine electronic equipment on

vessels. It is multi-master and self-configuring, and there is no central network controller. Equipment designed to this standard will have the ability to share data, including commands and status with other compatible equipment over a status with other compatible equipment over a single channel.

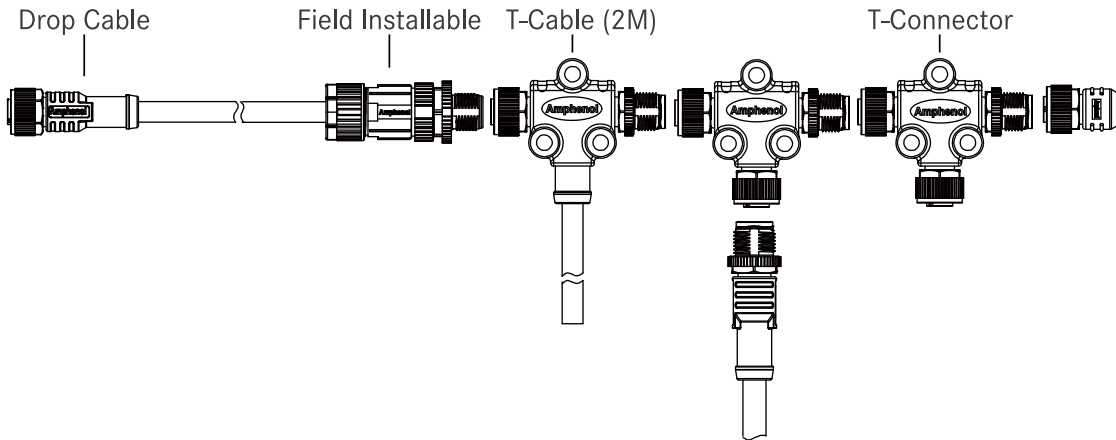

> Items (Mini to Micro)

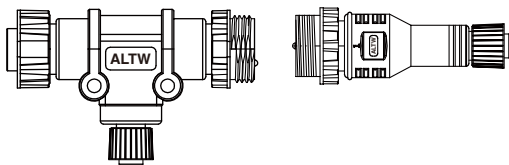

T-Adaptor  
° P13-17

I-Adaptor  
° P13-17

> Items for devices

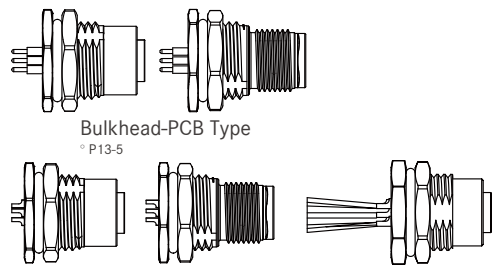

Bulkhead-PCB Type  
° P13-5

Bulkhead-Solder Type  
° P13-6

> Items for power source

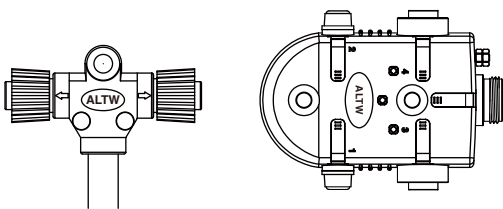

<Micro>  
T-cable  
° P13-11

<Mini>  
Power Tap Tee  
° P13-20

> More Selection

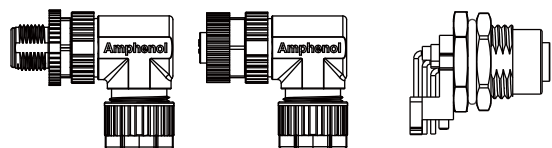

Field Installable  
° P13-9

Bulkhead  
(Right Angle)  
° P13-7

[ Note ] Design and specification are subject to change without notice.

# Specification

<b>Identifications</b>	Micro (AWG: 22 AWG, 24 AWG) Mini (AWG: 18 AWG, 15AWG)
<b>Description</b>	<p><b>Micro:</b> Bulkhead (With Wire / Double-ended / Right Angle) Cable (Drop Line / Double-ended Cordset / T-Cable) Field Installable Network Terminator (Single-ended / In-line) Adaptor (T-Adaptor / Elbow) Multi-port Waterproof Cap</p> <p><b>Mini:</b> Bulkhead (Double-ended) Cable (Drop Line / Double-ended Cordset / T-Cable) Field Installable Network Terminator (Single-ended) Adaptor (T-Adaptor / Elbow) Power Tap Tee Waterproof Cap</p> <p><b>Mini to Micro:</b> Adaptor (T-Adaptor / I-Adaptor)</p>
<b>Current Rating / Data</b>	Micro: 4A Mini: 8A
<b>Material</b>	Contacts: Copper Alloy, Gold Plated Contacts Holder: PA
<b>Waterproof Rating</b>	IP67~68
<b>Temperature Range</b>	Receptacle: -40°C ~ 85°C Overmolded with Cable: -20°C ~ 80°C Field Installable: Nylon+GF: -40°C ~ 105°C PU: -20°C ~ 85°C * Higer working temperature upon request.

## Contact Configuration

	Micro-C	Mini-C
	4A	8A
	FF or MM	FF or MM
4Pin		
5Pin		

4A  
 8A

**Number of Contacts:**  
e.g. 2 contacts (02)

**Connector (Housing) Gender:**  
Male(M) or Female(F)

**Contact Gender:**  
Male(M) or Female(F)

**More to Choose:**

- Solder (S)  
- Solder Cup

- Screw In (B)

## Cabling Information

### Micro

**NMEA Approved**

(A): (24#\* 1P+AL) + (22#\* 1P+AL) + Drain + Mylar + Braid

(B): (16#\* 1P+AL) + (20# \* 1P+AL) +D +AL +Braid

**Conforming**

(A): (24#\* 1P+AL) + (22#\* 1P+AL) + Drain + AL + Braid

(B): (22#\* 1P+AL) + (18#\* 1P+AL) + Drain + AL + Braid

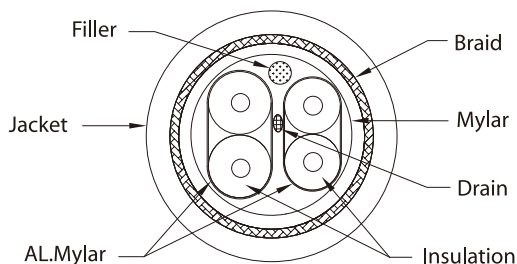

### Mini

**NMEA Approved**

(C): (18#\* 1P+AL) + (15#\* 1P+AL) + Drain + Braid

**Conforming**

(C): (18#\* 1P+AL) + (16#\* 1P+AL) + Drain + AL+Braid

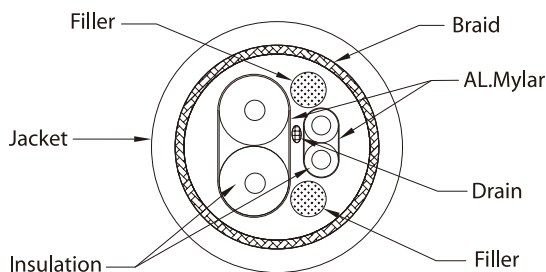

[ Note ] Design and specification are subject to change without notice.

## Find Our Standard Products

### Micro > Bulkhead (Double-ended)

<ul style="list-style-type: none"> <li>• 5 Contacts</li> <li>• Screw Thread</li> <li>• Unmated IP68</li> </ul>			
Type	Connector	Part Number (Female Connector / Female Contacts)	
Certified NMEA 2000 (4A, 60V)		UMC-000505-0FM-BS001	
None-Certified NMEA 2000 (4A, 60V)		MC-000505-0FM-BS001	

### Micro > Bulkhead (Straight) > PCB Type

<ul style="list-style-type: none"> <li>• 5 Contacts</li> <li>• Screw Thread</li> <li>• For Device Side</li> <li>• PCB Pin (180°)</li> <li>• Unmated IP68</li> </ul>		<p><b>Metal</b></p>	<p><b>Metal</b></p>
		<p><b>Plastic</b></p>	<p><b>Plastic</b></p>
Type	Connector	Part Number (Male Connector / Male Contacts)	Part Number (Female Connector / Female Contacts)
Certified NMEA 2000 (4A, 60V)	Metal	HMC-05PMMP-SF8001	HMC-05PFFP-SF8001
	Plastic	HPC-05PMMP-SF8001	HPC-05PFFP-SF8001

Micro > Bulkhead (Straight) > Solder Type

<ul style="list-style-type: none"> <li>• 5 Contacts</li> <li>• Screw Thread</li> <li>• For Device Side</li> <li>• Solder Pin (180°)</li> <li>• Unmated IP68</li> </ul>		<p><b>Certified</b></p> <p><b>Metal</b></p> <p>Maximum Panel Thickness: 4.5mm</p> <p><b>Plastic</b></p> <p>Maximum Panel Thickness: 4.5mm</p>		<p><b>Certified</b></p> <p><b>Metal</b></p> <p>Maximum Panel Thickness: 4.5mm</p> <p><b>Plastic</b></p> <p>Maximum Panel Thickness: 4.5mm</p>	
		<p><b>None-Certified</b></p> <p>Male: 25.9 Female: 22.9 Male: 20.5 Female: 20.0</p> <p>OD: 15.4 13.6</p> <p>18 (Hexagon)</p>		<p><b>None-Certified</b></p> <p>Male: 24.5 Female: 28.0 Male: 22.0 Female: 22.6</p> <p>OD: 15.4 13.6</p> <p>18 (Hexagon)</p>	
				Unit: mm	
Type	Connector	Part Number (Male Connector / Male Contacts)	Part Number (Female Connector / Female Contacts)		
Certified NMEA 2000 (4A, 60V)	Metal	HMC-05PMMS-SF8001	HMC-05PFFS-SF8001		
	Plastic	HPC-05PMMS-SF8001	HPC-05PFFS-SF8001		
None-Certified NMEA 2000 (4A, 60V)	Metal	MC-05PMMS-S <b>8</b> 8001	MC-05PFFS-S <b>8</b> 8001		

**8** Front Fastened (F) or Rear Fastened (H)

[Note] Design and specification are subject to change without notice.

Micro > Bulkhead (Right Angle)

<ul style="list-style-type: none"> <li>• 5 Contacts</li> <li>• Screw Thread</li> <li>• For device side</li> <li>• Unmated IP68 / Mated IP67</li> </ul>		<p>* IP 68 (Unmated)</p> <p>Male (29.5) Female (29.0) Male (20.5) Female (20.0)</p>	<p>* IP 67 (Mated)</p> <p>Male (24.8) Female (25.5) Male (16.2) Female (16.9)</p> <p>Unit: mm</p>
Type	Connector	Part Number (Male Connector / Male Contacts)	Part Number (Female Connector / Female Contacts)
None - Certified NMEA 2000 (4A, 60V)	Metal	12-05PMMR-SF7001	12-05PMMR-SF7001
	Plastic	12P-05PMMR-SF8001	12P-05PMMR-SF8001

Micro > Cable > Drop Line

<ul style="list-style-type: none"> <li>• 5 Contacts</li> <li>• Screw Thread</li> <li>• For Power Tap Connection</li> <li>• Mated IP68</li> <li>• Current Rating                     <ul style="list-style-type: none"> <li>- Connector: 4A</li> <li>- Cable: 3A</li> </ul> </li> </ul>			<p>Unit: mm</p>
Type	Connector	Part Number (Male Connector / Male Contacts)	Part Number (Female Connector / Female Contacts)
Certified NMEA 2000 (3A, 60V)	Metal	HMC-05BMMM-SL8A <u>XX</u> *	HMC-05BFFM-SL8A <u>XX</u> *
	Plastic	UMC-05BMMM-SL8A <u>XX</u> *	-
None - Certified NMEA 2000 (3A, 60V)	Metal	MC-05BMMM-SL8A <u>XX</u> *	MC-05BFFM-SL8A <u>XX</u> *
		MC-05BMMM-SL8B <u>XX</u> *	MC-05BFFM-SL8B <u>XX</u> *
	Plastic	MCP-05BMMM-SL8A <u>XX</u> *	MCP-05BFFM-SL8A <u>XX</u> *
		MCP-05BMMM-SL8B <u>XX</u> *	MCP-05BFFM-SL8B <u>XX</u> *

\*XX: Cable length available in 1M (01), 2M (02), 5M (05), 10M (10).

Micro > Power Cable

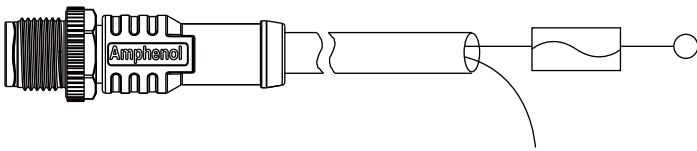
<ul style="list-style-type: none"> <li>• 5 Contacts</li> <li>• Screw Thread</li> <li>• For Powering NMEA 2000 Network System</li> <li>• Mated IP68</li> <li>• Current Rating                     <ul style="list-style-type: none"> <li>- Connector: 4A</li> <li>- Cable: 3A (With 3A Fuse)</li> </ul> </li> </ul>		Unit: mm		
<table border="1"> <tr> <td style="width: 50%;">Type</td> <td style="width: 50%;">Connector</td> </tr> </table>	Type	Connector	Part Number (Male Connector / Male Contacts)	
Type	Connector			
Certified NMEA 2000 (3A, 60V)	HPC-05CMMM-SL8A <u>XX</u> *			

\*XX: Cable length available in 1M (01), 2M (02), 5M (05), 10M (10).

Micro > Cable > Double-ended Cordset

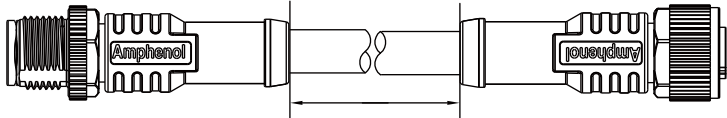
<ul style="list-style-type: none"> <li>• 5 contacts</li> <li>• Screw Thread</li> <li>• For Power Tap Connection</li> <li>• Mated IP68</li> <li>• Current Rating                     <ul style="list-style-type: none"> <li>- Connector: 4A</li> <li>- Cable: 3A</li> </ul> </li> </ul>								
<table border="1"> <tr> <td style="width: 50%;">Type</td> <td style="width: 50%;">Connector</td> </tr> </table>	Type	Connector	End 1	End 2	End 1	End 2	End 1	End 2
Type	Connector							
	Male	Female	Male	Female	Male	Female		
Certified NMEA 2000 (3A, 60V)	Metal	-	-	HMC-000505-0MF-CSA <u>XX</u> *				
	Plastic	-	-	UMC-000505-0MF-CS <u>XX</u> *				
None - Certified NMEA 2000 (3A, 60V)	Metal	MC-000505-0MM-C <u>XX</u> *	MC-000505-0FF-C <u>XX</u> *	MC-000505-0MF-CS <u>XX</u> *				
	Plastic	PC-000505-0MM-C <u>XX</u> *	PC-000505-0FF-C <u>XX</u> *	PC-000505-0MF-CS <u>XX</u> *				

\*Cable 22+24+B PVC

\*Available in 1, 2, 5, 10 M

\*XX: Cable length available in 1 (01), 2 (02), 5 (05), 10 (10)M.

[ Note ] Design and specification are subject to change without notice.



Micro > Power Cable (Double Ends)

<ul style="list-style-type: none"> <li>• 5 Contacts</li> <li>• Screw Thread</li> <li>• For Powering NMEA 2000 Network System</li> <li>• Mated IP68</li> <li>• Current Rating                             <ul style="list-style-type: none"> <li>- Connector: 4A</li> <li>- Cable: 3A</li> </ul> </li> </ul>			
Connector  Type		End 1	End 2
		Male	Female
Certified NMEA 2000 (3A, 60V)	Plastic	HPC-000505-0MF-DSAXX*	

\*XX: Cable length available in 1 (01), 2 (02), 5 (05), 10 (10)M.

Micro > Field Installable (Right Angle)

<ul style="list-style-type: none"> <li>• 5 contacts</li> <li>• Screw Thread</li> <li>• Screw-in Contacts</li> <li>• Mated IP67</li> </ul>				
		Unit: mm		
Type		Connector	Part Number (Male Connector / Male Contacts)	Part Number (Female Connector / Female Contacts)
Certified NMEA 2000 (4A, 60V)	Metal		HMC-05BMMB-SR7001 (Ø4.5 ~Ø6.0mm; 14AWG Max.)	HMC-05BFFB-SR7001 (Ø4.5 ~Ø6.0mm; 14AWG Max.)
	Plastic		HPC-05BMMB-SR7001 (Ø4.5 ~Ø6.0mm; 14AWG Max.)	HPC-05BFFB-SR7001 (Ø4.5 ~Ø6.0mm; 14AWG Max.)
None - Certified NMEA 2000 (4A, 60V)	Metal		12-05BMMB-SR7001 (Ø4.5 ~Ø6.0mm; 18AWG Max.)	12-05BFFB-SR7001 (Ø4.5 ~Ø6.0mm; 18AWG Max.)
	Plastic		12P-05BMMB-SR7001 (Ø4.5 ~Ø6.0mm; 18AWG Max.)	12P-05BFFB-SR7001 (Ø4.5 ~Ø6.0mm; 18AWG Max.)

▾ **Micro > Field Installable (Straight)**

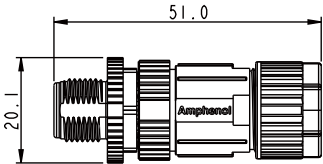
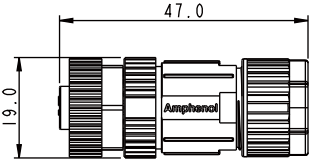
<ul style="list-style-type: none"> <li>• 5 contacts</li> <li>• Screw Thread</li> <li>• Screw-in Contacts</li> <li>• Mated IP67</li> </ul>					
		Unit: mm			
Connector		Part Number (Male Connector / Male Contacts)		Part Number (Female Connector / Female Contacts)	
Type	Metal	UMC-05BMMB-SL7001 (Ø4.5 ~ Ø7.5mm; 18AWG Max.)		UMC-05BFFB-SL7001 (Ø4.5 ~ Ø7.5mm; 18AWG Max.)	
	Plastic	HMC-05BMMB-SL7001 (Ø4.5 ~ Ø6.0mm; 14AWG Max.)		HMC-05BFFB-SL7001 (Ø4.5 ~ Ø6.0mm; 14AWG Max.)	
None - Certified NMEA 2000 (4A, 60V)	Metal	12-05BMMB-SL7001 (Ø4.5 ~ Ø6.0mm; 18AWG Max.)		12-05BFFB-SL7001 (Ø4.5 ~ Ø6.0mm; 18AWG Max.)	
	Plastic	12P-05BMMB-SL7001 (Ø4.5 ~ Ø6.0mm; 18AWG Max.)		12P-05BFFB-SL7001 (Ø4.5 ~ Ø6.0mm; 18AWG Max.)	

【Note】 Design and specification are subject to change without notice.

Micro > Cable > T-Cable

<ul style="list-style-type: none"> <li>• 5 contacts</li> <li>• Screw Thread</li> <li>• For Power Tap Connection</li> <li>• Mated IP68</li> <li>• Current Rating                             <ul style="list-style-type: none"> <li>- Connector: 4A</li> <li>- Cable: 3A</li> </ul> </li> </ul>									
						Unit: mm			
Type		Connector		End 1	End 2	End 1	End 2	End 1	End 2
				Male		Female		Male	Female
Certified NMEA 2000 (3A, 60V)	Metal			-	-			UMC-050500-FM0-TSAXX*	
	Plastic			-	-			HMC-050500-FM0-TSAXX*	
None - Certified NMEA 2000 (3A, 60V)	Metal	MC-050500-MM0-TSBXX*		MC-050500-FF0-TSBXX*		MC-050500-FM0-TSBXX*			
	Plastic	PC-050500-MM0-TSBXX*		PC-050500-FF0-TSBXX*		PC-050500-FM0-TSBXX*			

\*XX: Cable length available in 1 (01), 2 (02), 5 (05), 10 (10)M.

Micro > Network Terminator > Terminator

<ul style="list-style-type: none"> <li>• 5 contacts</li> <li>• Screw Thread</li> <li>• With 120Ω Resistor</li> <li>• Mated IP68</li> </ul>							
						Unit: mm	
Type		Connector		Part Number (Male Connector / Male Contacts)		Part Number (Female Connector / Female Contacts)	
Certified NMEA 2000 (3A, 60V)	Metal			HMC-05BMMT-SL8001		HMC-05BFFT-SL8001	
	Plastic			HMCP-05BMMT-SL8001		HMCP-05BFFT-SL8001	

Micro > Network Terminator > Terminator

<ul style="list-style-type: none"> <li>• 5 contacts</li> <li>• Screw Thread</li> <li>• With 120Ω Resistor</li> <li>• Mated IP68</li> </ul>			
Connector		Part Number (Male Connector / Male Contacts)	Part Number (Female Connector / Female Contacts)
Certified NMEA 2000 (3A, 60V)	Metal	UMC-05BMMT-SL8001	UMC-05BFFT-SL8001
None - Certified NMEA 2000 (3A, 60V)	Metal	MC-05BMMT-SL8001	MC-05BFFT-SL8001
	Plastic	MCP-05BMMT-SL8001	MCP-05BFFT-SL8001

Micro > Network Terminator > Terminator (In-Line)

<ul style="list-style-type: none"> <li>• 5 contacts</li> <li>• Screw Thread</li> <li>• With 120Ω Resistor</li> <li>• Mated IP68</li> </ul>					
Connector		End 1	End 2	End 1	End 2
Type		Male	Female	Male	Female
Certified NMEA 2000 (4A, 60V)	Metal	HMC-000505-0MF-IS001		-	
	Plastic	HPC-000505-0MF-IS001		-	
None - Certified NMEA 2000 (4A, 60V)	Metal		-	MC-000505-0MF-IS001	

[Note] Design and specification are subject to change without notice.

Micro > Adaptor > T-Adaptor

<ul style="list-style-type: none"> <li>• 5 contacts</li> <li>• Screw Thread</li> <li>• Mated IP68</li> </ul>			
		Unit: mm	
Type	Connector		End 1 (Female Connector / Female Contacts)
			End 2 (Male Connector / Male Contacts)
			End 3 (Female Connector / Female Contacts)
Certified NMEA 2000 (4A, 60V)	Metal	HMC-050505-FMF-TS001	
	Plastic	UMC-050505-FMF-TS001	
		HPC-050505-FMF-TS001	

Micro > Adaptor > Elbow (L-Adaptor)

<ul style="list-style-type: none"> <li>• 5 contacts</li> <li>• Screw Thread</li> <li>• Mated IP68</li> </ul>			
		Unit: mm	
Type	Connector		Part Number (Male Connector / Male Contacts)
			Part Number (Female Connector / Female Contacts)
Certified NMEA 2000 (4A, 60V)	Metal	HMC-000505-0FM-ES001	
	Plastic	HPC-000505-0FM-ES001	
None - Certified NMEA 2000 (4A, 60V)	Metal	MC-000505-0FM-ES001	

Micro > Multi-port T-Adaptor

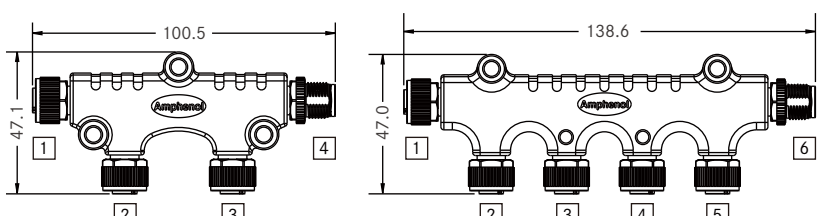
<ul style="list-style-type: none"> <li>• 5 contacts</li> <li>• Screw Thread</li> <li>• Mated IP68</li> </ul>			
		Unit: mm	
Type	Connector	End 1 (Female Connector / Female Contacts)	End 1 (Female Connector / Female Contacts)
		End 2 (Female Connector / Female Contacts)	End 2 (Female Connector / Female Contacts)
		End 3 (Female Connector / Female Contacts)	End 3 (Female Connector / Female Contacts)
		End 4 (Male Connector / Male Contacts)	End 4 (Female Connector / Female Contacts)
		-	End 5 (Female Connector / Female Contacts)
		-	End 6 (Male Connector / Male Contacts)
Certified NMEA 2000 (4A, 60V)	Metal	E-555500-FFFM00-S001	E-555555-FFFFFM-S001
	Plastic	H-555500-FFFM00-S001	H-555555-FFFFFM-S001
None - Certified NMEA 2000 (4A, 60V)	Metal	P-555500-FFFM00-S001	P-555555-FFFFFM-S001
		S-555500-FFFM00-S001	S-555500-FFFM00-S001

【Note】 Design and specification are subject to change without notice.

Micro > Multi-port > Box

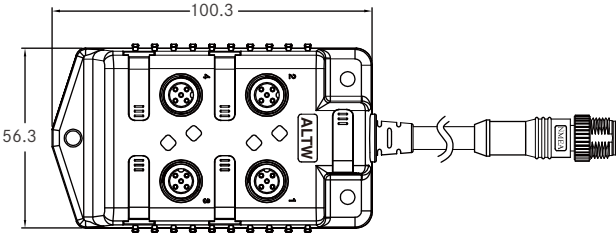
• Unmated IP68		
	Unit: mm	
Type	Part Number	
None - Certified NMEA 2000 (4A, 30V)	S-555500-FFFF00-SBXX*	
Certified NMEA 2000 (4A, 30V)	E-555500-FFFF00-SAXX*	

\* XX: Cable length available from 01 ~ 99m

Micro > Waterproof Cap

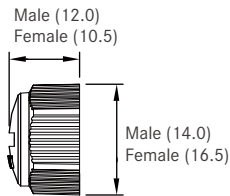
		* Plastic	* Metal	
				
		Unit: mm		
Size	Mating Pair	Mating Style	Mating Gender	Part Number
Micro	Receptacle	Screw Thread	Male	CAP-WBDMSPB2
	Receptacle and Overmolded with Cable		Male	CAP-WBDMSMA1 (Plastic)
			Male	CAP-WBDMSMA2 (Metal)
			Female	CAP-WBDFSMA1 (Plastic)
			Female	CAP-WBDFSMA2 (Metal)

Mini > Bulkhead (Double-ended)

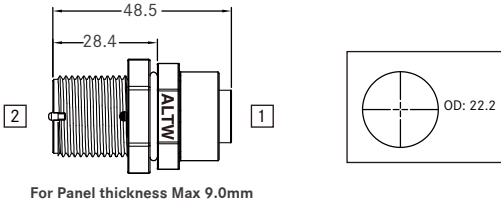
<p>• Unmated IP68</p>  <p style="text-align: right;">Unit: mm</p>	
<p>Connector Type</p>	<p>Connector 1 (Female Connector / Female Contacts)</p>
	<p>Connector 2 (Male Connector / Male Contacts)</p>
<p>None - Certified NMEA 2000 (8A, 60V)</p>	<p>MN-000505-0FM-BS001</p>
<p>Certified NMEA 2000 (8A, 60V)</p>	<p>UMN-000505-0FM-BS001</p>

Mini > Cable > Drop Line

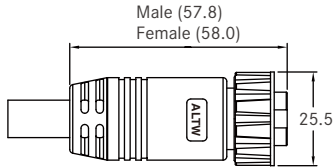
<p>• Mated IP68</p>  <p style="text-align: right;">Unit: mm</p>		
<p>Type</p>	<p>Part Number (Male Connector / Male Contacts)</p>	<p>Part Number (Female Connector / Female Contacts)</p>
<p>None - Certified NMEA 2000 (8A, 30V)</p>	<p>MN-05AMMM-SL8CXX*</p>	<p>MN-05AFFM-SL8CXX*</p>
<p>Certified NMEA 2000 (8A, 60V)</p>	<p>UMN-05AMMM-SL8CXX*</p>	<p>-</p>

\*XX: Cable length available in 1 (01), 2 (02), 5 (05), 10 (10)M.

[Note] Design and specification are subject to change without notice.



Mini > Cable > Double-ended Cordset

<ul style="list-style-type: none"> <li>• Mated IP68</li> </ul>		<p>* Available in 1, 2, 5, 10 M</p>
Connector Type	Connector 1 (Male Connector / Male Contacts)	Connector 2 (Female Connector / Female Contacts)
	None - Certified NMEA 2000 (8A, 30V)	MN-000505-0MF-CSCXX*
Certified NMEA 2000 (8A, 60V)	UMN-000505-0MF-CSCXX*	

\*XX: Cable length available in 1 (01), 2 (02), 5 (05), 10 (10)M.

Mini > Field Installable

<ul style="list-style-type: none"> <li>• Screw-in Contacts</li> <li>• Mated IP68</li> </ul>		<p>* Conforming to NMEA</p>	<p>* NMEA approved</p>
Type	Part Number (Male Connector / Male Contacts)	Part Number (Female Connector / Female Contacts)	
None - Certified NMEA 2000 (8A, 60V)	MN-05BMMB-SL7001	MN-05BFFB-SL7001	
Certified NMEA 2000 (8A, 60V)	UMN-05BMMB-SL7001	UMN-05BFFB-SL7001	

Unit: mm

\* Recommended Cable Information:  
 - None-Certified: Ø8 ~ Ø11mm; 15AWG Max.  
 - Certified NMEA 2000: Ø8 ~ Ø12.2mm; 15AWG Max.

Mini > T-Cable

<ul style="list-style-type: none"> <li>• Mated IP68</li> </ul>		
		Unit: mm
Connector  Type	Connector 1 (Female Connector / Female Contacts)	
	Connector 2 (Male Connector / Male Contacts)	
None - Certified NMEA 2000 (8A, 30V)	MN-050500-FM0-TSCXX*	

\*XX: Cable length available in 1 (01), 2 (02), 5 (05), 10 (10)M.

Mini > Network Terminator

<ul style="list-style-type: none"> <li>• With 120Ω Resistor</li> <li>• Mated IP68</li> </ul>	<ul style="list-style-type: none"> <li>* Conforming to NMEA</li> <li>* Signal function LED</li> </ul>		<ul style="list-style-type: none"> <li>* NMEA approved</li> </ul>		
Type	Part Number (Male Connector / Male Contacts)	Part Number (Female Connector / Female Contacts)			
None - Certified NMEA 2000 (8A, 250V)	MNL-05BMMT-SL8001	MNL-05BFFT-SL8001			
Certified NMEA 2000 (8A, 250V)	UMN-05AMMT-SL8001	UMN-05AFFT-SL8001			

[Note] Design and specification are subject to change without notice.

∟ Mini > T-Adaptor

• Mated IP68			
		Unit: mm	
Type	Connector	Connector 1 (Female Connector / Female Contacts)	
		Connector 2 (Male Connector / Male Contacts)	
		Connector 3 (Female Connector / Female Contacts)	
None-Certified NMEA 2000 (8A, 300V)		MN-050505-FMF-TS001	
Certified NMEA 2000 (8A, 300V)		UMN-050505-FMF-TS001	

∟ Mini > Adaptor > Elbow (L-Adaptor)

• Mated IP68			
		Unit: mm	
Type	Connector	Connector 1 (Female Connector / Female Contacts)	
		Connector 2 (Male Connector / Male Contacts)	
None-Certified NMEA 2000 (8A, 300V)		MN-000505-0FM-ES001	

Mini > Power Tap Tee

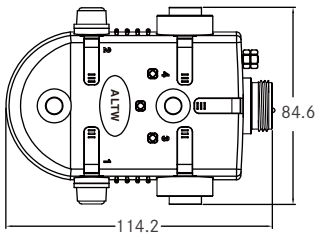
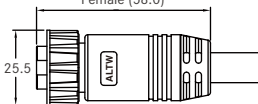
<ul style="list-style-type: none"> <li>• With replaceable fuse</li> <li>• Mated IP68</li> </ul>		<p>Recommended Mating Pair MN-04AFFM-SL8DXX</p> <p>Male (57.8) Female (58.0)</p>  <p>*XX: Cable length available in 1(01), 2(02), 5(05), 10(10)M.</p> <p>Unit: mm</p>
<p>Connector</p> <p>Type</p>	Connector 1 (Male Connector / Male Contacts)	
	Connector 2 (Female Connector / Female Contacts)	
	Connector 3 (Female Connector / Female Contacts)	
None-Certified NMEA 2000 (8A, 250V)	N-455000-MFF000-S001	
Certified NMEA 2000 (8A, 250V)	U-455000-MFF000-S001	

Mini > Waterproof Cap

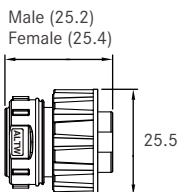
<ul style="list-style-type: none"> <li>• 5 Contacts</li> <li>• Screw Thread</li> <li>• Mated IP68</li> </ul>	 <p>Male (25.2) Female (25.4)</p> <p>25.5</p> <p>Unit: mm</p>			
Size	Mating Pair	Mating Style	Mating Gender	Part Number
Mini	Receptacle and Overmolded with Cable	Screw Thread	Female	CAP-WMNMSMA1
			Male	CAP-WMNFSA1

[Note] Design and specification are subject to change without notice.

↳ Mini to Micro > T-Adaptor

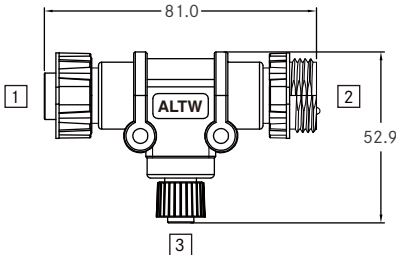
<p>• Mated IP68</p>		 <p style="text-align: right;">Unit: mm</p>	
<p>Connector</p>	<p>Connector 1 (Female Connector / Female Contacts)</p>		
	<p>Connector 2 (Male Connector / Male Contacts)</p>		
	<p>Connector 3 (Female Connector / Female Contacts)</p>		
<p>Type</p>			
<p>None- Certified NMEA 2000 (4A, 60V)</p>	<p>NC-050505-FMF-TS001</p>		
<p>Certified NMEA 2000 (4A, 60V)</p>	<p>UNC-050505-FMF-TS001</p>		

↳ Mini to Micro > I-Adaptor

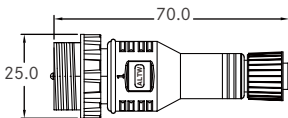
<p>• Mated IP68</p>		 <p style="text-align: right;">Unit: mm</p>	
<p>Type</p>	<p>Part Number</p>		
<p>None- Certified NMEA 2000 (4A, 60V)</p>	<p>NC-000505-0MF-IS001</p>		

# Memo

Lined area for writing a memo, consisting of horizontal dashed lines.



Scan to visit our website