

HDSP-511x, HDSP-513x, and HDSP-515A

14.22-mm (0.56-in.) General-Purpose Seven-Segment Display

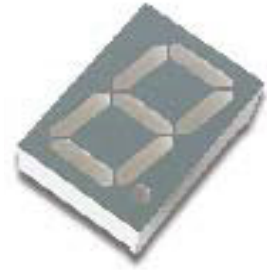

Description

This 14.22-mm (0.56-in.) LED seven-segment display uses industry-standard size package and pinout. The device is available in either common anode or common cathode. The choice of colors includes High Efficiency Red (HER), Green, AlGaAs Red, and Yellow. The displays are suitable for indoor use.

Applications

- Suitable for indoor use
- Not recommended for industrial application, that is, operating temperature requirements exceeding +85°C or below -25°C (for additional details, contact your local Broadcom® sales office or an authorized distributor)
- Extreme temperature cycling not recommended

Features

- Industry standard size
- Industry standard pinout
14.22-mm (0.56-in.) DIP lead on 2.54 mm
- Choice of colors
High Efficiency Red (HER), Green, AlGaAs Red, and Yellow
- Excellent appearance
Evenly lighted segments package gives optimum contrast
± 50° viewing angle
- Design flexibility
Common anode or common cathode
Single digit
Right-hand decimal point
- Categorized for luminous intensity
Green and yellow categorized for color

Devices

HER	Green	AlGaAs Red	Yellow	Description
HDSP-511E	HDSP-511G	HDSP-511A	HDSP-511Y	Common Anode, Gray Surface, Right-Hand Decimal
HDSP-513E	HDSP-513G	HDSP-513A	HDSP-513Y	Common Cathode, Gray Surface, Right-Hand Decimal
—	—	HDSP-515A	—	Common Cathode, Black Surface, Right-Hand Decimal

Part Numbering System

5 0 8 2 - x₁ x₂ x₃ x₄ - x₅ x₆ x₇ x₈ x₉

H D S P - x₁ x₂ x₃ x₄ - x₅ x₆ x₇ x₈ x₉

Placeholder	Description	Option	Setting	Notes
x ₁	Package			a
x ₂ x ₃	Device Specific Configuration			a
x ₄	Device Configuration/Color	A	AlGaAs Red	a
		E	High Efficiency Red	
		G	Green	
		Y	Yellow	
x ₅	Minimum Intensity Bin	0	No minimum intensity bin limitation	a, b
x ₆	Maximum Intensity Bin	0	No maximum intensity bin limitation	a, b
x ₇	Color Bin Options	0	No color bin limitation	a, b
x ₈ x ₉	Mechanical Options	00	No mechanical option	a

- a. For codes not listed in the figure, refer to the respective data sheet or contact your nearest Broadcom representative for details.
- b. Bin options, refer to shippable bins for a part number. Color and intensity bins are typically restricted to one bin per tube (exceptions may apply). Refer to the respective data sheet for specific bin limit information.

Package Dimensions

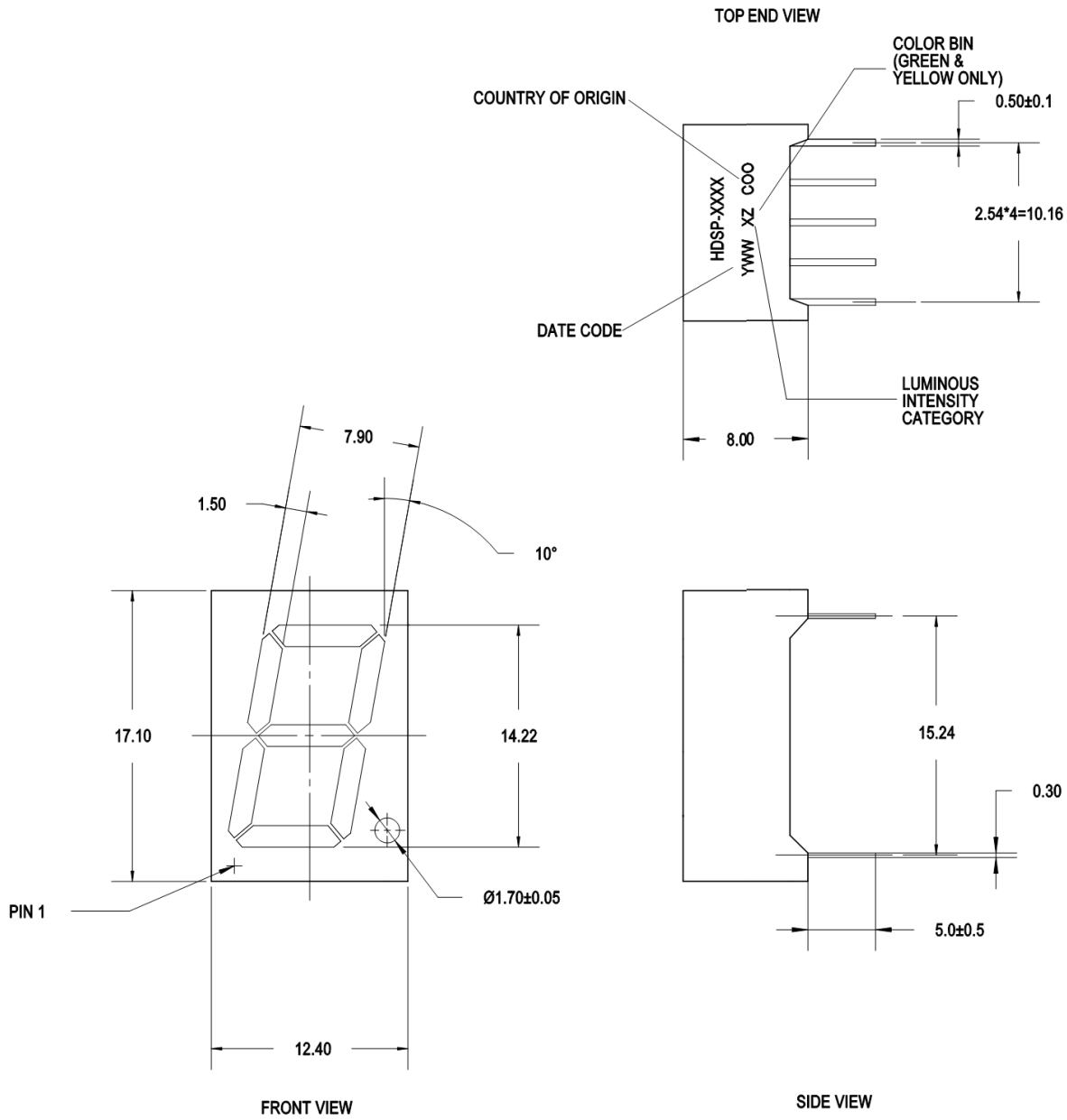

NOTE:

1. All dimensions are in millimeters (mm).
2. Tolerance is ± 0.25 mm unless otherwise specified.

Internal Circuit Diagram

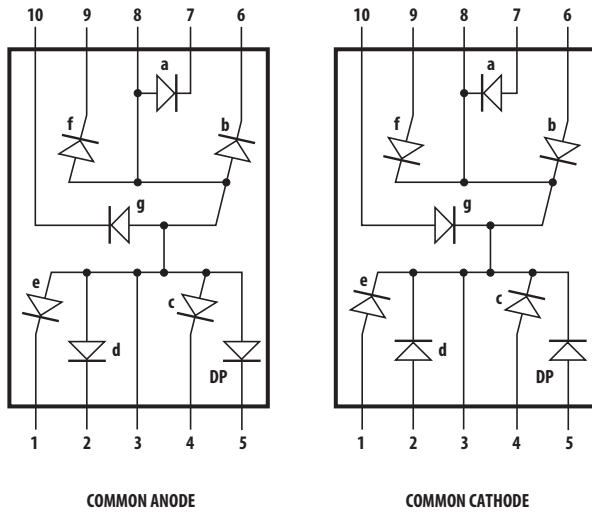

HDSP-511E/511G/511Y/511A		HDSP-513E/513G/513Y/513A/515A	
COMMON ANODE		COMMON CATHODE	
PIN	FUNCTION	PIN	FUNCTION
1	CATHODE e	1	ANODE e
2	CATHODE d	2	ANODE d
3	COMMON ANODE	3	COMMON CATHODE
4	CATHODE c	4	ANODE c
5	CATHODE DP	5	ANODE DP
6	CATHODE b	6	ANODE b
7	CATHODE a	7	ANODE a
8	COMMON ANODE	8	COMMON CATHODE
9	CATHODE f	9	ANODE f
10	CATHODE g	10	ANODE g

Absolute Maximum Ratings at T_A = 25°C

Description	HER HDSP-51xE	Green HDSP-51xG	AlGaAs Red HDSP-51xA	Yellow HDSP-51xY	Units
Power Dissipation Segment	60	65	30	52	mW
Forward Current Segment	25 ^a	25 ^b	15 ^c	20 ^d	mA
Peak Forward Current per Segment (1/10 Duty Factor at 10 kHz)	100	100	80	80	mA
Operating Temperature Range	-35 to +85	-35 to +85	-35 to +85	-35 to +85	°C
Storage Temperature Range	-35 to +85	-35 to +85	-35 to +85	-35 to +85	°C
Reverse Voltage per Segment or DP	5	5	5	5	V
Wavesoldering Temperature for 3 seconds (at 2-mm distance from the body)	250	250	250	250	°C

- a. Derate above 25°C at 0.33 mA/°C.
- b. Derate above 25°C at 0.33 mA/°C.
- c. Derate above 25°C at 0.2 mA/°C.
- d. Derate above 25°C at 0.27 mA/°C.

Electrical/Optical Characteristics at $T_A = 25^\circ\text{C}$

High Efficiency Red (HER)

Device HDSP-	Parameter	Symbol	Min.	Typ.	Max.	Units	Test Conditions
511E 513E	Luminous Intensity/Segment	I_V	—	1.73	—	mcd	$I_F = 5\text{ mA}$
			2.001	4.100	—	mcd	$I_F = 10\text{ mA}$
	Forward Voltage	V_F	—	2.05	2.40	V	$I_F = 20\text{ mA}$
	Peak Wavelength	λ_{PEAK}	—	635	—	nm	
	Dominant Wavelength	λ_d	—	620	—	nm	
Reverse Voltage	V_R	5	—	—	V	$I_R = 100\text{ }\mu\text{A}$	

Green

Device HDSP-	Parameter	Symbol	Min.	Typ.	Max.	Units	Test Conditions
511G 513G	Luminous Intensity/Segment	I_V	2.001	4.100	—	mcd	$I_F = 10\text{ mA}$
	Forward Voltage	V_F	—	2.06	—	V	$I_F = 10\text{ mA}$
			1.80	2.25	2.60	V	$I_F = 20\text{ mA}$
	Peak Wavelength	λ_{PEAK}	—	568	—	nm	
	Dominant Wavelength	λ_d	—	573	—	nm	
Reverse Voltage	V_R	5	—	—	V	$I_R = 100\text{ }\mu\text{A}$	

AlGaAs Red

Device HDSP-	Parameter	Symbol	Min.	Typ.	Max.	Units	Test Conditions
511A 513A 515A	Luminous Intensity/Segment	I_V	—	4.93	—	mcd	$I_F = 5\text{ mA}$
			3.201	6.500	—	mcd	$I_F = 10\text{ mA}$
	Forward Voltage	V_F	—	1.85	2.00	V	$I_F = 20\text{ mA}$
	Peak Wavelength	λ_{PEAK}	—	660	—	nm	
	Dominant Wavelength	λ_d	—	643	—	nm	
Reverse Voltage	V_R	5	—	—	V	$I_R = 100\text{ }\mu\text{A}$	

Yellow

Device HDSP-	Parameter	Symbol	Min.	Typ.	Max.	Units	Test Conditions
511Y 513Y	Luminous Intensity/Segment	I_V	—	1.03	—	mcd	$I_F = 5 \text{ mA}$
			1.251	2.600	—	mcd	$I_F = 10 \text{ mA}$
	Forward Voltage	V_F	—	2.15	2.60	V	$I_F = 20 \text{ mA}$
	Peak Wavelength	λ_{PEAK}	—	595	—	nm	
	Dominant Wavelength	λ_d	—	590	—	nm	
Reverse Voltage	V_R	5	—	—	V	$I_R = 100 \mu\text{A}$	

Intensity Bin Limits (mcd at 10 mA)

Bin Name	HER/Green		Yellow		AlGaAs Red	
	Min. ^a	Max. ^a	Min. ^a	Max. ^a	Min. ^a	Max. ^a
H	N/A	N/A	1.251	2.000	N/A	N/A
I	2.001	3.200	2.001	3.200	N/A	N/A
J	3.201	5.050	3.201	5.050	3.201	5.050
K	5.051	8.000	N/A	N/A	5.051	8.000
L	N/A	N/A	N/A	N/A	8.001	12.650

a. Tolerance for each bin limit is ± 10%.

Color Bin Limits (nm)

Color	Dominant Wavelength (nm)		
	Bin	Min. ^a	Max. ^a
Green	3	569.1	571.0
	4	571.1	573.0
	5	573.1	575.0
Yellow	1	585.5	588.5
	2	588.5	591.5
	3	591.5	594.5

a. Tolerance for each bin limit is 1 nm.

High Efficiency Red (HER)

Figure 1: Maximum Allowable Average or DC Current vs. Ambient Temperature

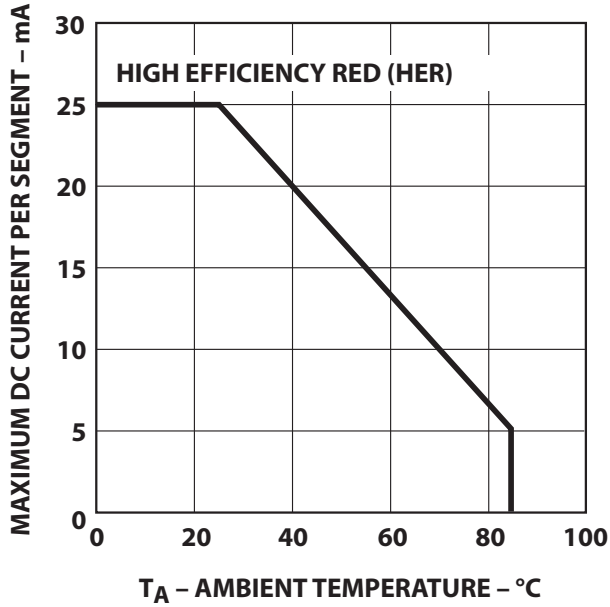

Figure 2: Forward Current vs. Forward Voltage

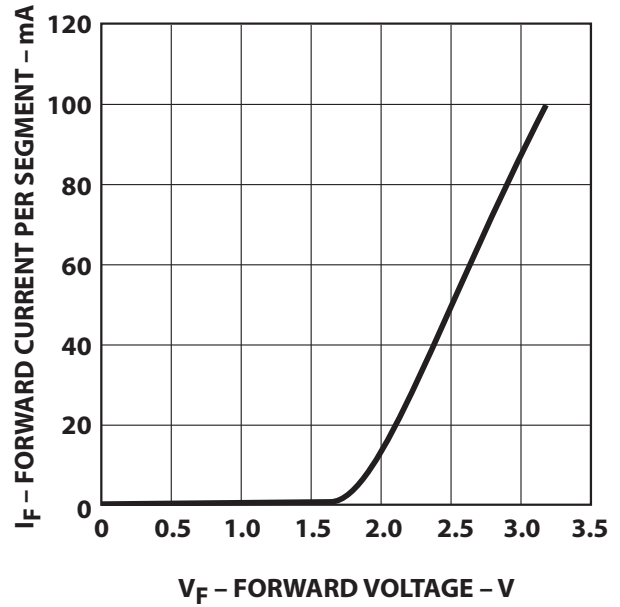

Figure 3: Relative Luminous Intensity vs. DC Forward Current

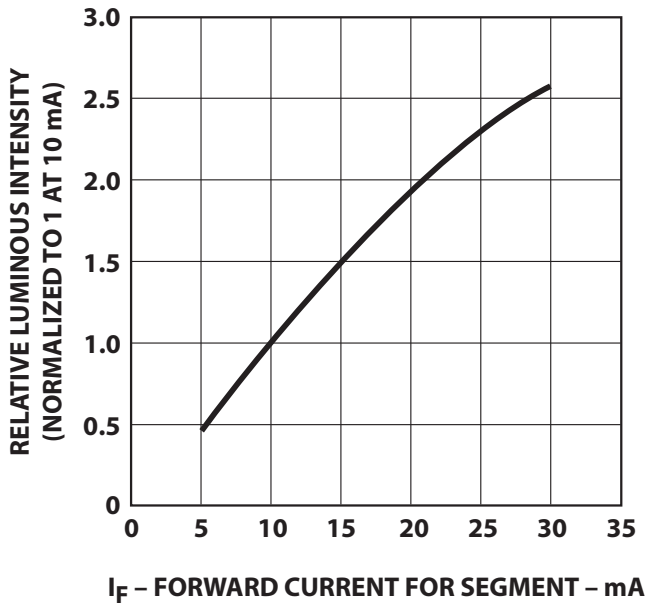
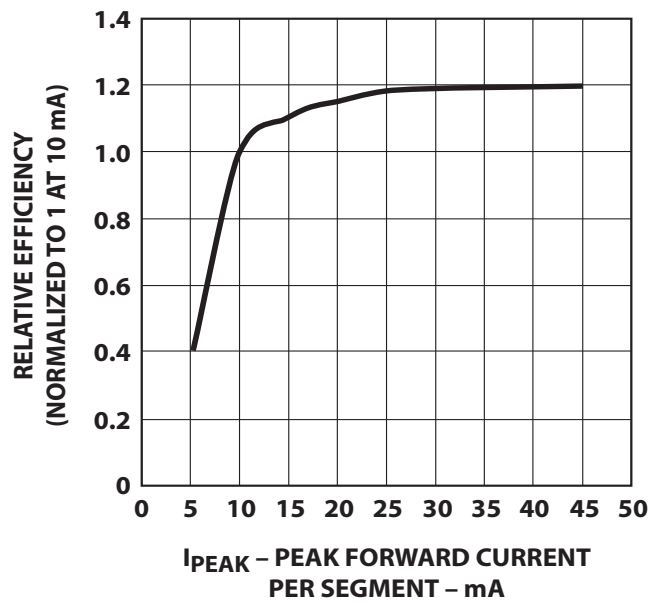

Figure 4: Relative Efficiency (Luminous Intensity per Unit Current) vs. Peak Current



Green

Figure 5: Maximum Allowable Average or DC Current vs. Ambient Temperature

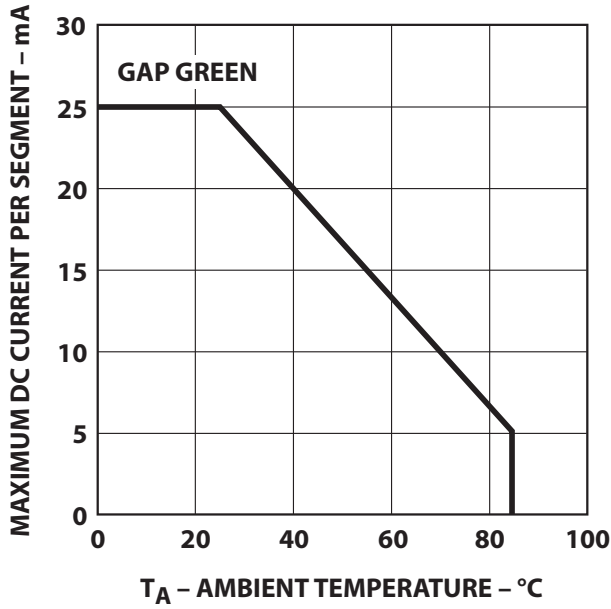

Figure 6: Forward Current vs. Forward Voltage

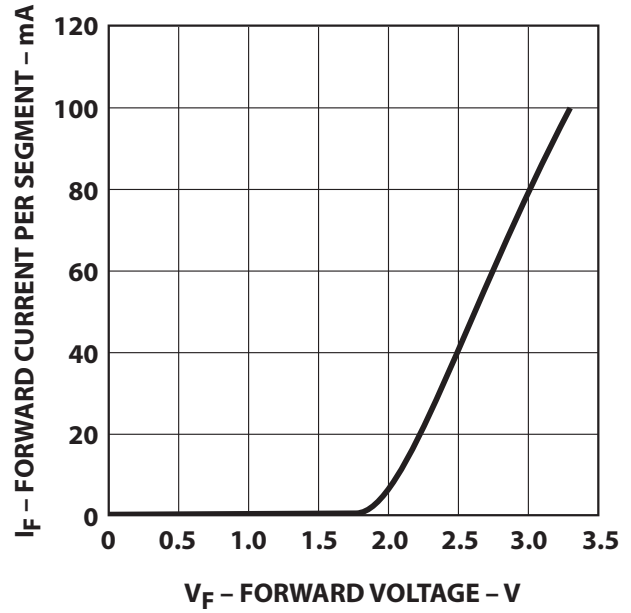

Figure 7: Relative Luminous Intensity vs. DC Forward Current

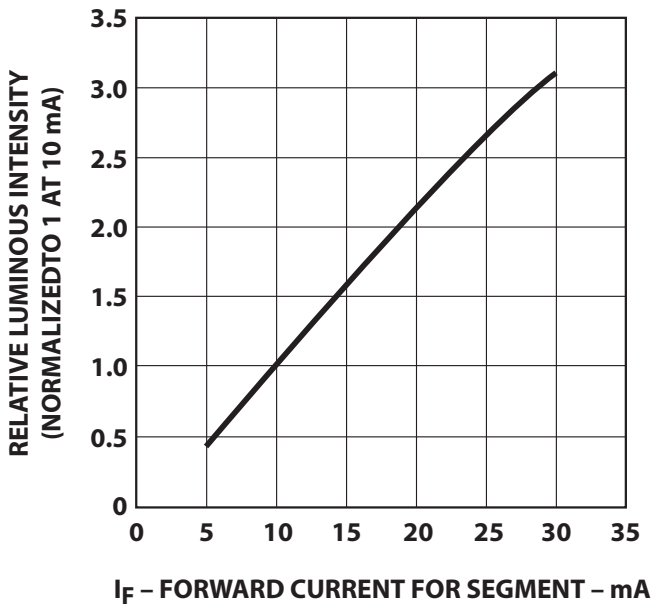
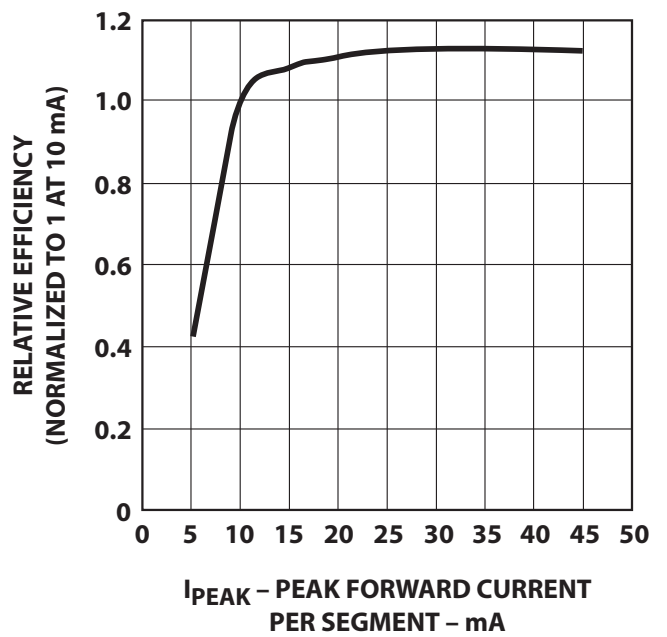

Figure 8: Relative Efficiency (Luminous Intensity per Unit Current) vs. Peak Current



AlGaAs Red

Figure 9: Maximum Allowable Average or DC Current vs. Ambient Temperature

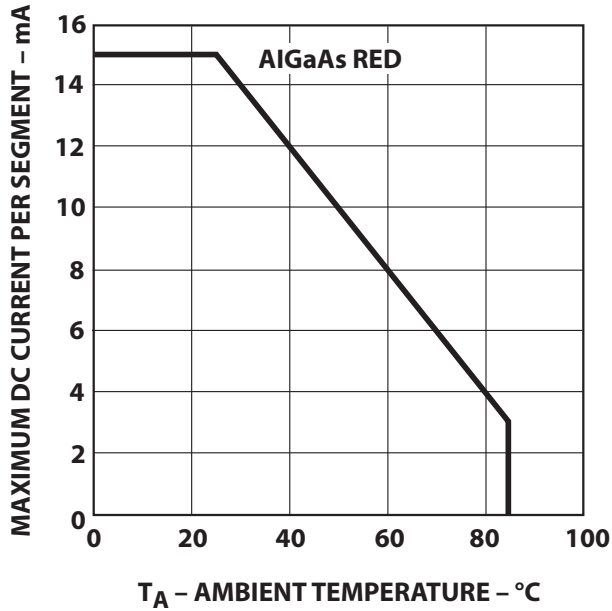

Figure 10: Forward Current vs. Forward Voltage

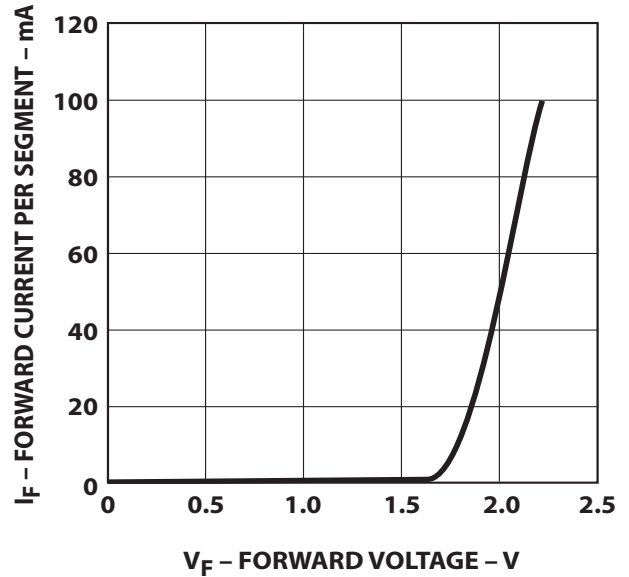

Figure 11: Relative Luminous Intensity vs. DC Forward Current

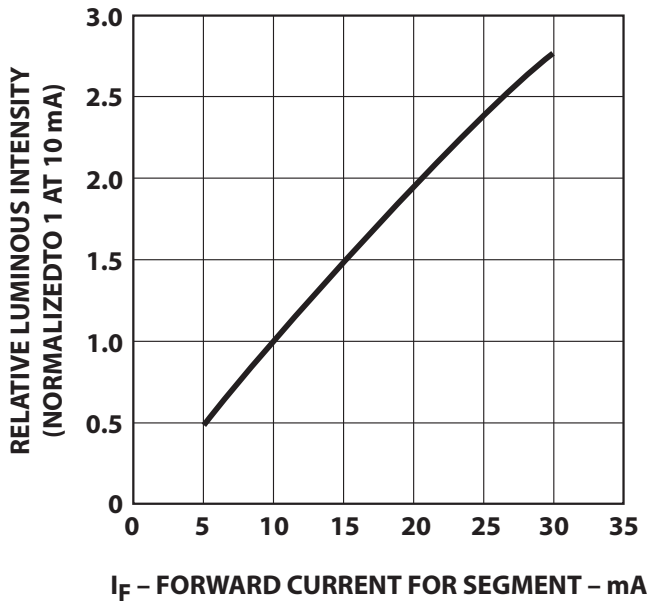
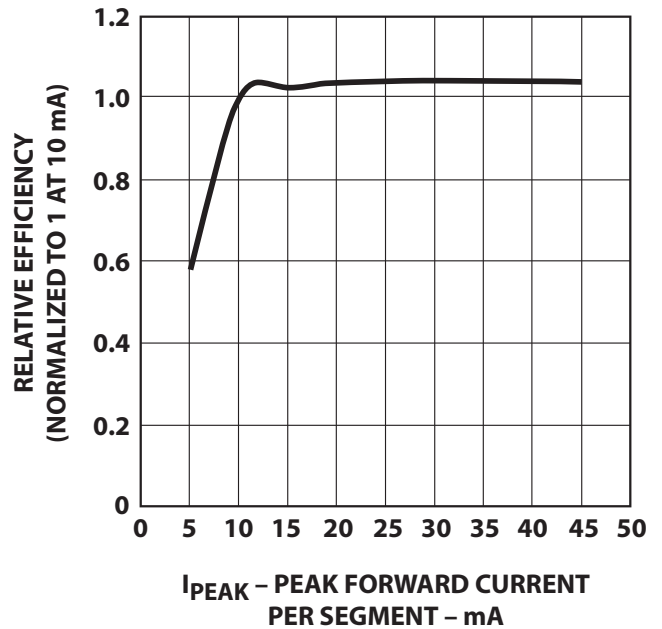

Figure 12: Relative Efficiency (Luminous Intensity per Unit Current) vs. Peak Current



Yellow

Figure 13: Maximum Allowable Average or DC Current vs. Ambient Temperature

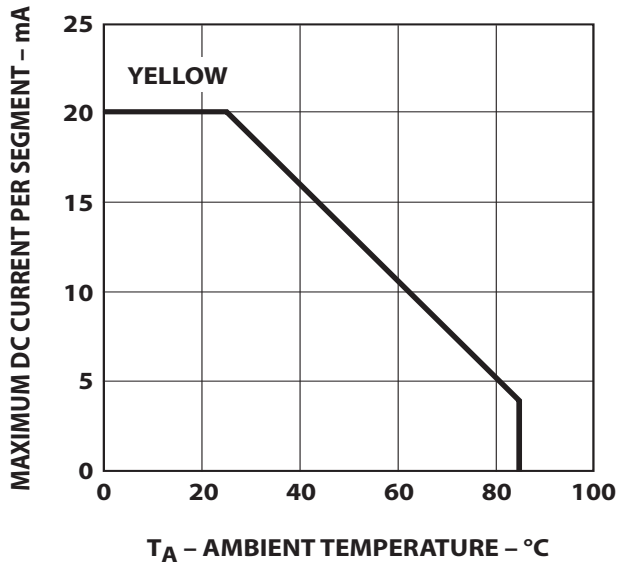

Figure 14: Forward Current vs. Forward Voltage

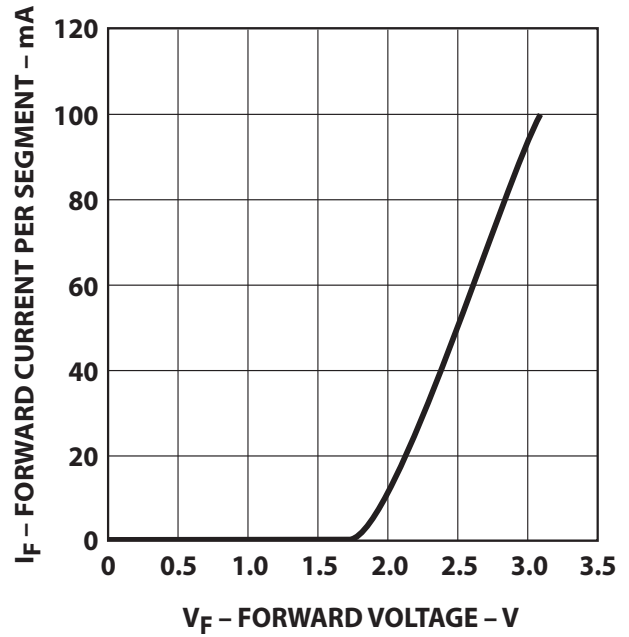

Figure 15: Relative Luminous Intensity vs. DC Forward Current

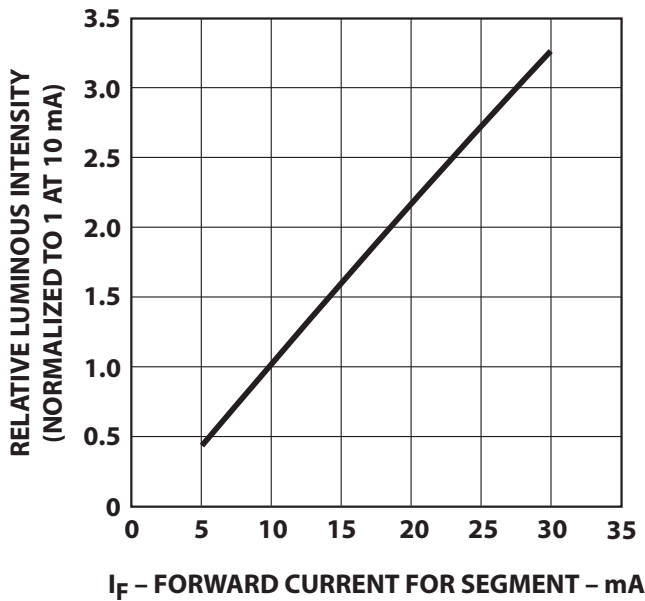
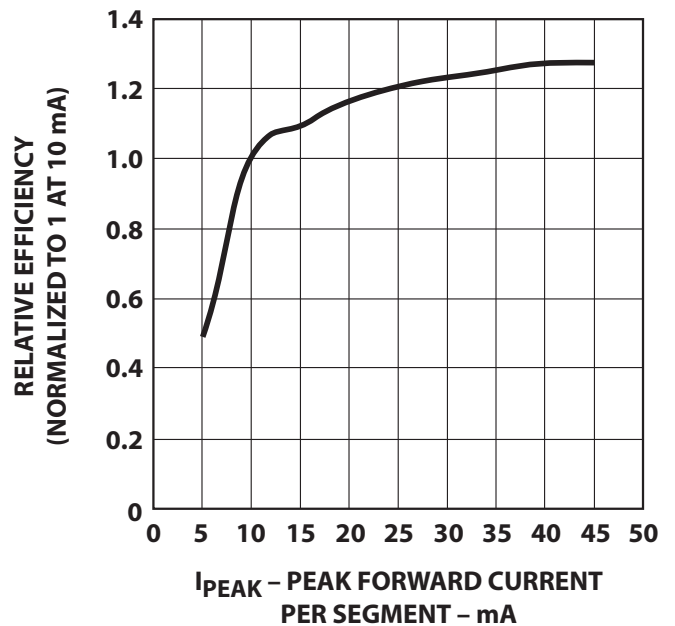

Figure 16: Relative Efficiency (Luminous Intensity per Unit Current) vs. Peak Current



Broadcom, the pulse logo, Connecting everything, Avago Technologies, Avago, and the A logo are among the trademarks of Broadcom and/or its affiliates in the United States, certain other countries, and/or the EU.

Copyright © 2008–2019 Broadcom. All Rights Reserved.

The term “Broadcom” refers to Broadcom Inc. and/or its subsidiaries. For more information, please visit www.broadcom.com.

Broadcom reserves the right to make changes without further notice to any products or data herein to improve reliability, function, or design. Information furnished by Broadcom is believed to be accurate and reliable. However, Broadcom does not assume any liability arising out of the application or use of this information, nor the application or use of any product or circuit described herein, neither does it convey any license under its patent rights nor the rights of others.