

## HCP-14

Product Family: HCP

Ostby Barton: HC93

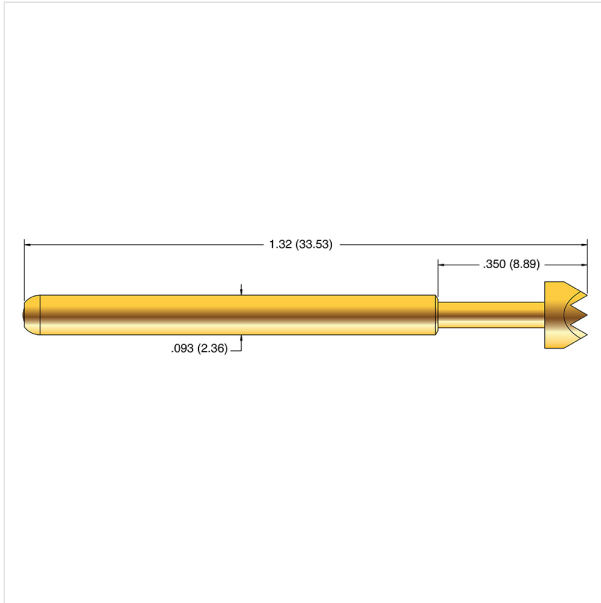

### Mechanical:

**Test Center (mil):** 187

**Test Center (mm):** 4.75

**Overall Length (mil):** 1,320

**Overall Length (mm):** 33.53

**Full Travel (mil):** 250

**Full Travel (mm):** 6.35

**Recommended Travel (mil):** 167

**Recommended Travel (mm):** 4.24

**Mechanical Life (no of cycles):** 250,000

### Thermal:

**Max Operating Temp (°C):** 150

**Min Operating Temp (°C):** -55

### Electrical:

**Current Rating (Amps):** 25

**Average Probe Resistance (mOhm):** 25

### Springs

Force Type - Preload in oz (g) - Rec. Travel in oz (g) -

Spring Material

Standard - 0.86 (24.00) - 4.80 (136.00) - Stainless Steel, Silver plated

Alternate - 4.32 (122.00) - 12.00 (340.00) - Stainless Steel, Silver plated

### Body Type

Straight

Pylon Bend

### Materials & Finishes:

**Plunger Material:** Heat-treated BeCu, Gold plated over hard Nickel

**Barrel Material:** Phosphor Bronze, Gold plated over Silver

**Bias Ball Material:** Stainless Steel

**Terminal Ball Material:** Stainless Steel

TIPS:

Tip Materials: BeCu

Tips:

HCP-14A

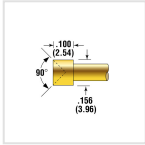

HCP-14B

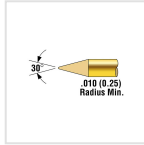

HCP-14H

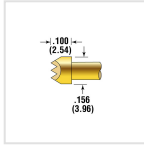

Related Products:

SPR-4W

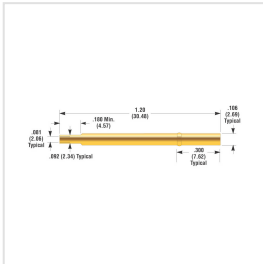

SPR-4W-1

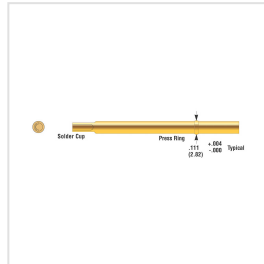

SPR-4W-2

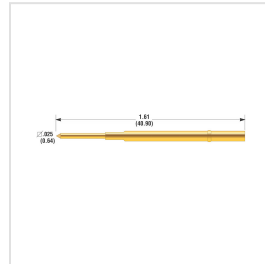

SPR-4Y

