

SECTION H



Table of Contents



Single Pole Plugs and Receptacles



Spider® II Temporary Power Boxes



Temporary Lighting and Maintenance Worklights



Single Pole Devices	Page
Series 15 - 150 Ampere, 600V AC/250V DC	
Features and Benefits	H-2
Plugs, Receptacles, Protective Caps and Snap Back Covers	H-3
Tees, Gender Reversing, Replacement Bodies and Accessories	H-4
Specifications and Dimensions	H-5
Series 16 - 300 and 400 Ampere, 600V AC/250V DC	
Features and Benefits	H-2
Plugs and Receptacles	H-6
Receptacles, Terminals, Protective Caps and Weather Protective Covers	H-7
Tees, 3-Fers, Gender Reversing Devices, and Distribution Block	H-8
Replacement Parts, Snap Back Covers and Accessories	H-8
Specifications and Dimensions	H-9
Series 18 - 300 and 400 Ampere, 600V AC/250V DC	
Features, 300 & 400A Plugs	H-10
Replacement Bodies and Accessories	H-10
Specifications and Dimensions	H-10

Temporary Power	Page
Spider® II Temporary Power Boxes	
Features and Benefits	H-11
50A and 60A Spider® II Boxes	H-12
Cable Sets, Receptacles and Replacement Parts	H-13
Temporary Power Boxes and Power Cables	H-14
Heavy-Duty Portable Outlet Boxes and Cover Plates	H-15
Temporary Lighting	
Construction Site Lighting	H-16
Maintenance Worklights, Accessories and Replacement Items	H-17
Explosion Proof/Confined Space Lighting	H-17
Pre-Wired Portable Outlet Boxes, Worklights and Accessories	H-18



Features and Benefits

Series 15 and 16 - 150, 300 and 400 Ampere, 600V AC/250V DC

Hubbell Wiring Device-Kellems offers a full line of innovative, high quality, Series 15 and Series 16 single pole plugs, receptacles and accessories for the most demanding environments.

Single pole devices are the right choice for supplying temporary electrical power distribution for entertainment, theme parks, carnival equipment, concerts, movie making and numerous other applications requiring temporary power.

Single pole devices have been designed with ease of assembly and disassembly in mind, no special tools are required. A high strength non-conductive retaining screw is all that is needed to securely lock the contacts to the insulated sleeve.

UL Enclosure Types 3R, 4X and 12 Rating suitable for use in almost any environment.



HBL15MBK



HBL15FBK



Housing Design

- Insulgrip® style housing for superior gripping, conforms to the user's hand making it easy to connect and disconnect, even with gloves on
- Easily identifiable cable, cut off points for secure fit allows you to easily customize and cut the housing to the required/correct cable size
- Accommodates wide range of cables



Contacts

- Provides high contact pressure and vibration resistant connection, which helps reduce operating temperatures and extends product life
- High conductivity brass contact provides improved performance by helping to reduce operating temperatures and extends life



Safety

- Rounded corners reduce the possibility of catching or snagging on structures or equipment
- Non-conductive retaining screw locks contacts in place and allows for easy installation; prevents contact movement within housing
- Recessed mounting screw minimizes screwdriver slippage



Assembly

- Special screw thread requires fewer turns than most competitors and reduces the risk of a conductive screw being substituted
- Extra long non-conductive inner sleeve reduces force required to install housing over contacts; easier to rotate contact in body for installing retaining screw



Identification

- Lock symbol aids in the mating of devices and provides a clear indication that the devices are properly connected
- With lock indicator symbol making mating clear and simple; devices can lock 180° to prevent unintended disconnects



Installation

- Engineered body design makes installation simple with no need for additional tools and the non-metallic retaining screw helps to make operation safe for all involved
- Strip gauge molded into every plug and receptacle housing; simplifies installation and saves time

Single Pole Devices and Temporary Power



Series 15 - 150 Ampere, 600V AC/250V DC

Enclosure Types
3R, 4X, 12



Plugs, Male

Description	Color	Male Plug
150 amp, thermoplastic elastomer, cable size #8 - #2 AWG.	Black	HBL15MBK
	White	HBL15MW
	Green	HBL15MGN
	Red	HBL15MR
	Blue	HBL15MBL
	Brown	HBL15MBN
	Orange	HBL15MO
	Yellow	HBL15MY
	Gray	HBL15MGY



Plugs, Female

Description	Color	Female Plug
150 amp, thermoplastic elastomer, cable size #8 - #2 AWG.	Black	HBL15FBK
	White	HBL15FW
	Green	HBL15FGN
	Red	HBL15FR
	Blue	HBL15FBL
	Brown	HBL15FBN
	Orange	HBL15FO
	Yellow	HBL15FY
	Gray	HBL15FGY



Receptacles, Stud Type

Description	Color	Female Receptacles	Male Receptacles
150 amp, Panel Mount, thermoplastic, cable size #8 - #2 AWG.	Black	HBL15FRSBK	HBL15MRSBK
	White	HBL15FRSW	HBL15MRSW
	Green	HBL15FRSGN	HBL15MRSGN
	Red	HBL15FRSR	HBL15MRSR
	Blue	HBL15FRSBL	HBL15MRSBL
	Brown	HBL15FRSBN	HBL15MRSBN
	Orange	HBL15FRSO	HBL15MRSO
	Yellow	HBL15FRSY	HBL15MRSY
	Gray*	—	—

Note: *Gray is available upon request. Contact factory.



Receptacles, Double Set Screw

Description	Color	Female Receptacles	Male Receptacles
150 amp, Panel Mount, thermoplastic, cable size #8 - #2 AWG.	Black	HBL15FRBK	HBL15MRBK
	White	HBL15FRW	HBL15MRW
	Green	HBL15FRGN	HBL15MRGN
	Red	HBL15FRR	HBL15MRR
	Blue	HBL15FRBL	HBL15MRBL
	Brown	HBL15FRBN	HBL15MRBN
	Orange	HBL15FRO	HBL15MRO
	Yellow	HBL15FRY	HBL15MRY
	Gray	HBL15FRGY	HBL15MRGY



Protective Caps

Description	Color	Fits Female Devices	Fits Male Devices
Fits 150 amp plugs and receptacles.	Black	HBL15FCAPBK	HBL15MCAPBK
	White	HBL15FCAPW	HBL15MCAPW
	Green	HBL15FCAPGN	HBL15MCAPGN
	Red	HBL15FCAPR	HBL15MCAPR
	Blue	HBL15FCAPBL	HBL15MCAPBL
	**	—	—

Note: **Additional colors are available upon request. Contact factory.



Weather Protective Covers

Description	Color	Catalog Number
Use with stud type or double set screw receptacles.	Clear	HBL15NCC
	Black	HBL15NCBK
	White	HBL15NCW
	Green	HBL15NCGN
	Red	HBL15NCR
	Blue	HBL15NCBL
	**	

Tees



Color	Tapping Tee (Female-Female-Male)	Paralleling Tee (Female-Male-Male)
Black	HBL15TBK	HBL15PTBK
White	HBL15TW	HBL15PTW
Green	HBL15TGN	HBL15PTGN
Red	HBL15TR	HBL15PTR
Blue	HBL15TBL	HBL15PTBL

Gender Reversing Devices



Color	Double Male (Male-Male)	Double Female (Female-Female)
Black	HBL15DMBK*	HBL15DFBK*
White	HBL15DMW	HBL15DFW
Green	HBL15DMGN	HBL15DFGN
Red	HBL15DMR*	HBL15DFR*
Blue	HBL15DMBL*	HBL15DFBL*

Note: *UL 1691 restricts the use of male-to-male or female-to-female devices to Grounding (Green) or Neutral (White) conductors. Consult factory for availability of other non UL listed colors.

Replacement Bodies (25 Pack)



Color	Male Body	Female Body
Black	HBL15MBBK	HBL15FBBK
White	HBL15MBW	HBL15FBW
Green	HBL15MBGN	HBL15FBGN
Red	HBL15MBR	HBL15FBR
Blue	HBL15MBBL	HBL15FBL

Note: **Additional colors are available upon request. Contact factory.

Replacement Contacts (25 Pack)



Description	Male Pin	Female Sleeve
Contact, 150 amp	HBL15RCM	HBL15RCF

Accessories

Description	Catalog Number
Accessory Kit, retaining screw, copper foil, terminal screws and brass wire.	HBL15PK
Replacement retaining screw (100 pack).	HBL15RS
Copper foil (100 pack).	HBL15CF
Brass wire (100 pack).	HBL15BW
Terminal screw - inline (100 pack).	HBL15TS25
Terminal screw - panel mount (100 pack).	HBL15TS375
Ferrule #2 AWG (100 pack).	HBL15F2
Ferrule #4 AWG (100 pack).	HBL15F4



HBL15PK



HBL15RS



HBL15CF



HBL15BW



HBL15TS25



HBL15TS375



HBL15F2
HBL15F4

Single Pole Devices and Temporary Power



Series 15 - 150 Ampere, 600V AC/250V DC

Specifications

Electrical	
Voltage Ratings	600V AC Maximum 250V DC Maximum
Amperage Rating	150A Maximum
Mechanical	
Terminal Accommodation	Plug: #8 AWG to #2 AWG Receptacle: #8 AWG to #2 AWG
Product ID	Ratings are a permanent part of device
Base Compound	Plug: Thermoplastic Elastomer (TPE) Receptacle: Polybutylene Terephthalate (PBT)
Contact Material	Brass
Retaining Screw Material	Nylon

Certification / Environmental

UL and cUL Listed
 UL Enclosure Types 3R, 4X, 12
 UL1691 standard for single pole locking-type separable connectors
 National Electric Code (NEC®), ANSI/NFPA 70
 Flammability: HB per UL94 or CSA 22.2. 0.17

Conductor Ampacity Chart (Type SC/PPC Wire)

Cable Size	Ampacity*
#8	80
#6	105
#4	140
#2	190

Note: *90°C column NEC Table 400.5(A)(2).

Dimensions

In Line Plugs

	A	B	C	D
Male	4.54" (115.3)	1.04" (26.4)	.86" (21.8)	3.22" (81.7)
Female	4.60" (116.8)	1.11" (28.2)	.68" (17.3)	3.28" (83.2)

Weatherproof Cover

	A	B	C
Series 15	2.03" (51.5)	1.14" (29.0)	1.49" (37.9)

Male In Line Plug

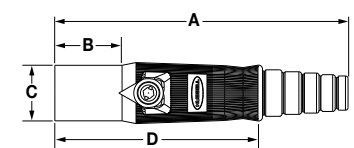

Female In Line Plug

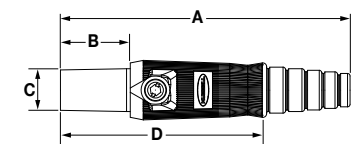

Panel Mount Receptacles

Threaded Stud	A	B	C	D	E	F	Mounting Hole	Termination
Male	1.86" (47.2)	1.37" (34.8)	2.82" (71.6)	.86" (22.0)	.80" (20.4)	1.20" (30.5)	Through 3x Ø .20"	5/16-18 Threaded Stud
Female	1.86" (47.2)	1.37" (34.8)	2.88" (73.1)	.86" (22.0)	.80" (20.4)	1.26" (32.0)	Through 3x Ø .20"	5/16-18 Threaded Stud
Double Set Screw	A	B	C	D	E	F	Mounting Hole	Termination
Male	1.86" (47.2)	1.37" (34.8)	2.90" (73.6)	.86" (22.0)	.88" (22.2)	1.20" (30.5)	Through 3x Ø .20"	(2) 5/32 Socket Head Set Screws
Female	1.86" (47.2)	1.37" (34.8)	2.95" (74.9)	.86" (22.0)	.87" (22.2)	1.26" (32.0)	Through 3x Ø .20"	(2) 5/32 Socket Head Set Screws

Weatherproof Cover

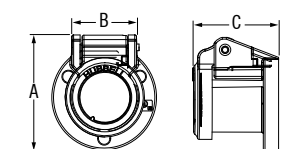

Tees

	A	B	C
Tapping Tee	2.67" (67.9)	4.28" (108.7)	.865" (21.9)
Paralleling Tee	2.67" (67.9)	4.22" (107.2)	.865" (21.9)

Gender Reversing Devices

	A	B	C
Double Male	4.22" (107.2)	.86" (21.8)	—
Double Female	4.22" (107.2)	1.05" (26.7)	.68" (17.3)

Tapping Tee

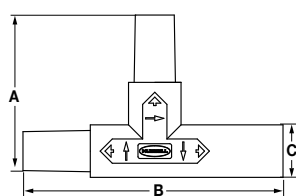

Paralleling Tee

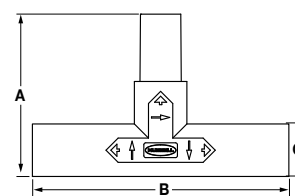

Gender Reversing - Double Male

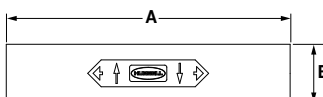

Gender Reversing - Double Female

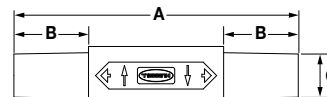

Threaded Stud (Male Shown)

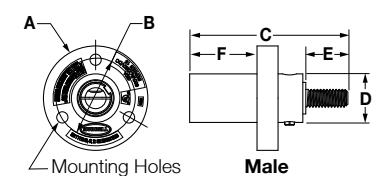

Double Set Screw (Male Shown)

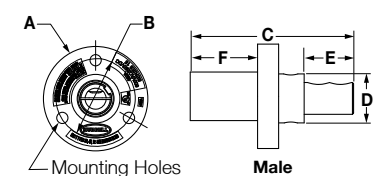

Single Pole Devices and Temporary Power



Series 16 - 300 and 400 Ampere, 600V AC/250V DC

Enclosure Types
3R, 4X, 12



Plugs

Description	Color	Male Plug	Female Plug
300 amp, thermoplastic elastomer, cable size #6 - 2/0 AWG.	Black	HBL300MBK	HBL300FBK
	White	HBL300MW	HBL300FW
	Green	HBL300MGN	HBL300FGN
	Red	HBL300MR	HBL300FR
	Blue	HBL300MBL	HBL300FBL
	Brown	HBL300MBN	HBL300FBN
	Orange	HBL300MO	HBL300FO
	Yellow	HBL300MY	HBL300FY
	Gray*	—	—

Note: *Gray is available upon request. Contact factory.



Plugs

Description	Color	Male Plug	Female Plug
400 amp, thermoplastic elastomer, cable size 2/0 - 4/0 AWG.	Black	HBL400MBK	HBL400FBK
	White	HBL400MW	HBL400FW
	Green	HBL400MGN	HBL400FGN
	Red	HBL400MR	HBL400FR
	Blue	HBL400MBL	HBL400FBL
	Brown	HBL400MBN	HBL400FBN
	Orange	HBL400MO	HBL400FO
	Yellow	HBL400MY	HBL400FY
	Gray	HBL400MGY	HBL400FGY

Receptacles, Stud Type



Description	Color	Through Hole Mounting		Threaded Hole Mounting		Angled Receptacles	
		Female Receptacles	Male Receptacles	Female Receptacles	Male Receptacles	Female Receptacles	Male Receptacles
400 amp Panel Mount, thermoplastic elastomer, mates with 300 and 400 amp plugs.	Black	HBLFRSBK	HBLMRSBK	HBLFRSCBK	HBLMRSCBK	HBLFRASBK	HBLMRASBK
	White	HBLFRSW	HBLMRSW	HBLFRSCW	HBLMRSCW	HBLFRASW	HBLMRASW
	Green	HBLFRSGN	HBLMRSGN	HBLFRSCGN	HBLMRSCGN	HBLFRASGN	HBLMRASGN
	Red	HBLFRSR	HBLMRSR	HBLFRSCR	HBLMRSCR	HBLFRASR	HBLMRASR
	Blue	HBLFRSBL	HBLMRSBL	HBLFRSCL	HBLMRSCBL	HBLFRASBL	HBLMRASBL
	Brown	HBLFRSBN	HBLMRSBN	HBLFRSCBN	HBLMRSCBN	HBLFRASBN	HBLMRASBN
	Orange	HBLFRSO	HBLMRSO	HBLFRSCO	HBLMRSCO	HBLFRASO	HBLMRASO
Yellow	HBLFRSY	HBLMRSY	HBLFRSCY	HBLMRSCY	HBLFRASY	HBLMRASY	

Receptacles, Double Set Screw



Description	Color	Female Receptacles	Male Receptacles
400 amp, Panel Mount, thermoplastic elastomer, cable size #4 - 4/0 AWG, mates with 300 and 400 amp plugs.	Black	HBLFRBK	HBLMRBK
	White	HBLFRW	HBLMRW
	Green	HBLFRGN	HBLMRGN
	Red	HBLFRR	HBLMRR
	Blue	HBLFRBL	HBLMRBL
	Brown	HBLFRBN	HBLMRBN
	Orange	HBLFRO	HBLMRO
	Yellow	HBLFRY	HBLMRY
Gray	HBLFRGY	HBLMRGY	

Angled Receptacles, Double Set Screw



Description	Color	Female Receptacles	Male Receptacles
400 amp, Panel Mount, thermoplastic elastomer, cable size #4 - 4/0 AWG, mates with 300 and 400 amp plugs.	Black	HBLFRABK	HBLMRABK
	White	HBLFRAW	HBLMRAW
	Green	HBLFRAGN	HBLMRAGN
	Red	HBLFRAR	HBLMRAR
	Blue	HBLFRABL	HBLMRABL
	Brown	HBLFRABN	HBLMRABN
	Orange	HBLFRAO	HBLMRAO
	Yellow	HBLFRAY	HBLMRAY
	Gray*	—	—

Note: *Gray is available upon request. Contact factory.

Single Pole Devices and Temporary Power



Series 16 - 300 and 400 Ampere, 600V AC/250V DC

Enclosure Types
3R, 4X, 12



Receptacles, Bus Bar Mount

Description	Color	Female Receptacles	Male Receptacles
400 amp Panel Mount, thermoplastic elastomer, mates with 300 and 400 amp plugs.	Black	HBLFRBBK	HBLMRBBK
	White	HBLFRBW	HBLMRBW
	Green	HBLFRBGN	HBLMRBGN
	Red	HBLFRBR	HBLMRBR
	Blue	HBLFRBBL	HBLMRBBL
	Brown	HBLFRBBN	HBLMRBBN
	Orange	HBLFRBO	HBLMRBO
	Yellow	HBLFRBY	HBLMRBY



Angled Receptacles, Bus Bar Mount

Description	Color	Female Receptacles	Male Receptacles
400 amp Panel Mount, thermoplastic elastomer, mates with 300 and 400 amp plugs.	Black	HBLFRABK	HBLMRABK
	White	HBLFRABW	HBLMRABW
	Green	HBLFRABGN	HBLMRABGN
	Red	HBLFRABR	HBLMRABR
	Blue	HBLFRABBL	HBLMRABBL
	Brown	HBLFRABN	HBLMRABN
	Orange	HBLFRABO	HBLMRABO
	Yellow	HBLFRABY	HBLMRABY



Terminals, Offset Straight Style

Description	Color	Female Receptacles	Male Receptacles
400 amp Terminal, thermoplastic elastomer, mates with 300 and 400 amp plugs.	Black	HBLFOSBK	HBLMOSBK
	White	HBLFOSW	HBLMOSW
	Green	HBLFOSGN	HBLMOSGN
	Red	HBLFOSR	HBLMOSR
	Blue	HBLFOSBL	HBLMOSBL
	Brown	HBLFOSBN	HBLMOSBN
	Orange	HBLFOSO	HBLMOSO
	Yellow	HBLFOSY	HBLMOSY

Note: Terminals are UL Type 1 only.



Angled Terminals, Offset Straight Style

Description	Color	Female Receptacles	Male Receptacles
400 amp Terminal, thermoplastic elastomer, mates with 300 and 400 amp plugs.	Black	HBLFOABK	HBLMOABK
	White	HBLFOAW	HBLMOAW
	Green	HBLFOAGN	HBLMOAGN
	Red	HBLFOAR	HBLMOAR
	Blue	HBLFOABL	HBLMOABL
	Brown	HBLFOABN	HBLMOABN
	Orange	HBLFOAO	HBLMOAO
	Yellow	HBLFOAY	HBLMOAY

Note: Angled terminals are UL Type 1 only.



Protective Caps

Color	Fits Female Devices	Fits Male Devices
Black	HBLFCAPBK	HBLMCAPBK
White	HBLFCAPW	HBLMCAPW
Green	HBLFCAPGN	HBLMCAPGN
Red	HBLFCAPR	HBLMCAPR
Blue	HBLFCAPBL	HBLMCAPBL
Brown	HBLFCAPBN	HBLMCAPBN
Orange	HBLFCAPO	HBLMCAPO
Yellow	HBLFCAPY	HBLMCAPY



Weather Protective Lift Covers

Color	Catalog Number	All One Color Caps and Bodies
Clear	—	HBLNCC
Black	HBLNCBK	HBLNCABK
White	HBLNCW	HBLNCAW
Green	HBLNCGN	HBLNCAGN
Red	HBLNCR	HBLNCAR
Blue	HBLNCBL	HBLNCABL
Brown	HBLNCBN	HBLNCABN
Orange	HBLNCO	HBLNCAO
Yellow	HBLNCY	HBLNCAY

Single Pole Devices and Temporary Power



Series 16 - 300 and 400 Ampere, 600V AC/250V DC

Enclosure Types
3R, 4X, 12



Tees and 3-Fers

Color	Tapping Tee (Female-Female-Male)	Paralleling Tee (Female-Male-Male)	3-Fer (Male-Female- Female-Female)	3-Fer (Female-Male- Male-Male)	Soft 3-Fer (Male-Female- Female-Female)	Soft 3-Fer (Female- Male-Male-Male)
Black	HBLTBK	HBLPTBK	HBLM3FBK	HBLF3MBK	HBLM3FSBK	—
White	HBLTW	HBLPTW	HBLM3FW	HBLF3MW	—	—
Green	HBLTGN	HBLPTGN	HBLM3FGN	HBLF3MGN	—	HBLF3MSGN
Red	HBLTR	HBLPTR	HBLM3FR	HBLF3MR	—	—
Blue	HBLTBL	HBLPTBL	HBLM3FBL	HBLF3MBL	—	—
Brown	HBLTBN	HBLPTBN	HBLM3FBN	HBLF3MBN	—	—
Orange	HBLTO	HBLPTO	HBLM3FO	HBLF3MO	—	—
Yellow	HBLTY	HBLPTY	HBLM3FY	HBLF3MY	—	—

Gender Reversing Devices



Color	Double Male (Male-Male)	Double Female (Female-Female)
Black	HBLDMBK	HBLDFBK
White	HBLDMW	HBLDFW
Green	HBLDMGN	HBLDFGN
Red	HBLDMR	HBLDFR
Blue	HBLDMBL	HBLDFBL
Brown	HBLDMBN	HBLDFBN
Orange	HBLDMO	HBLDFO
Yellow	HBLDMY	HBLDFY

Distribution Block

Color	(1-Male, 6-Females)
Black	HBL7DBBK
White	HBL7DBW
Green	HBL7DBGN
Red	HBL7DBR
Blue	HBL7DBBL
Brown	HBL7DBBN
Orange	HBL7DBO
Yellow	HBL7DBY



Replacement Bodies (10 Pack)



Color	Male Body	Female Body
Black	HBLMBBK	HBLFBBK
White	HBLMBW	HBLFBW
Green	HBLMBGN	HBLFBGN
Red	HBLMBR	HBLFBR
Blue	HBLMBBL	HBLFBBL
Brown	HBLMBBN	HBLFBBN
Orange	HBLMBO	HBLFBO
Yellow	HBLMBY	HBLFBY

Replacement Contacts (20 Pack)



Description	Male Pin	Female Sleeve
Contact, 300 amp	HBL300RCM	HBL300RCF
Contact, 400 amp	HBL400RCM	HBL400RCF

Snap Back Covers (3R Only)



Color	Through Hole Mounting	Threaded Mounting Holes
Black	HBLSCBK	HBLSCCBK
White	HBLSCW	HBLSCCW
Green	HBLSCGN	HBLSCCGN
Red	HBLSCR	HBLSCCR
Blue	HBLSCBL	HBLSCCBL
Brown	HBLSCBN	HBLSCCBN
Orange	HBLSCO	HBLSCCO
Yellow	HBLSCY	HBLSCCY

Accessories

Description	Catalog Number
Accessory Kit, retaining screw, copper foil, terminal screws and brass wire.	HBLPK
Replacement retaining screw (500 pack).	HBLRS
Copper foil (500 pack).	HBLCF
Brass wire (500 pack).	HBLBW
Terminal screw - inline (500 pack).	HBLTS
Terminal screw - panel mount (500 pack).	HBLTSR



Single Pole Devices and Temporary Power



Series 16 - 300 and 400 Ampere, 600V AC/250V DC

Specifications

Electrical	Series 16	
Voltage Ratings	600V AC Maximum 250V DC Maximum	
Amperage Rating	400A Maximum	
Mechanical	300A	400A
Terminal Accommodation	Plug: #6 to 2/0 AWG	Plug: 2/0 to 4/0 AWG Recept.: #4 to 4/0 AWG
Product ID	Ratings are a permanent part of device	
Base Compound	Thermoplastic Elastomer (TPE)	
Contact Material	Brass	
Retaining Screw Material	Nylon	

Certification / Environmental

UL and cUL Listed
 UL Enclosure Types 3R, 4X, 12
 UL1691 standard for single pole locking-type separable connectors
 National Electric Code (NEC), ANSI/NFPA 70
 Flammability: HB per UL94 or CSA 22.2. 0.17

Conductor Ampacity Chart (Type SC/PPC Wire)

Cable Size	Ampacity*	Cable Size	Ampacity*
#6	105	2/0	300
#4	140	4/0	405
#2	190		

Note: *90°C column NEC Table 400.5(A)(2).

Dimensions

In Line Plugs

Description	A	B	C	D
Male	7.01" (178.0)	1.38" (35.1)	1.48" (37.6)	4.78" (121.4)
Female	7.10" (180.5)	1.44" (36.6)	1.06" (27.0)	4.90" (121.3)

In Line Plug (Male Shown)

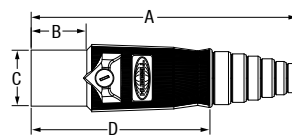

Snap Back Cover

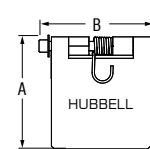

Threaded Stud (Male Shown)

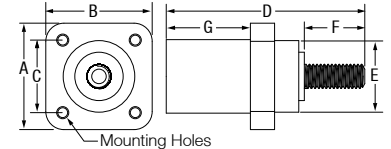

Panel Mount Receptacles

Threaded Stud	A	B	C	D	E	F	G	Mounting Hole	Termination
Male & Female with through hole mounting	2.20" (55.9)	2.20" (55.9)	1.50" (38.1)	4.10" (104.3)	1.48" (47.4)	1.25" (31.7)	1.74" (44.2)	Through 4x Ø .20"	1/2-13 UNC-2A Threaded Stud
Male & Female with threaded mounting holes	2.20" (55.9)	2.20" (55.9)	1.50" (38.1)	3.67" (93.2)	1.48" (47.4)	1.11" (28.2)	1.55" (39.4)	Threaded 4x #10-32	1/2-13 UNC-2A Threaded Stud
Double Set Screw	A	B	C	D	E	F	G	Mounting Hole	Termination
Male & Female with threaded mounting holes	2.20" (55.9)	2.20" (55.9)	1.50" (38.1)	4.10" (104.3)	1.48" (47.4)	1.36" (34.5)	1.74" (44.2)	Threaded 4x #10-32	(2) 7/32 Socket Head Set Screws
Busbar Type	A	B	C	D	E	F	G	Mounting Hole	Termination
Male & Female with threaded mounting holes	2.20" (55.9)	2.20" (55.9)	1.50" (38.1)	3.57" (90.7)	1.48" (37.6)	1.01" (25.7)	1.55" (39.4)	Threaded 4x #10-32	(1) 5/16-18 UNC-2B Threaded Hole
Offset Terminals	A	B	C	D	E	F	Mounting Hole	Termination	
Male terminal straight style	Ø1.48" [37.6]	1.00" (25.4)	.38" (9.5)	3.89" (98.8)	1.75" (44.5)	2.14" (54.4)	Through .50" (12.7)		—
Female terminal straight style	Ø1.48" [37.6]	1.00" (25.4)	.38" (9.5)	3.68" (93.3)	1.75" (44.5)	1.93" (48.9)	Through .50" (12.7)		—
Male terminal angled style	Ø1.48" [37.6]	1.00" (25.4)	.38" (9.5)	3.98" (101.1)	2.06" (52.2)	2.14" (54.4)	Through .50" (12.7)		—
Female terminal angled style	Ø1.48" [37.6]	1.00" (25.4)	.38" (9.5)	3.76" (95.6)	2.06" (52.2)	1.93" (48.9)	Through .50" (12.7)		—

Double Set Screw (Male Shown)

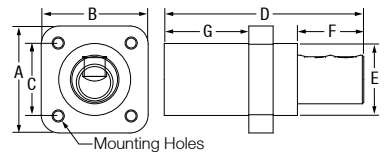

Busbar Type (Male Shown)

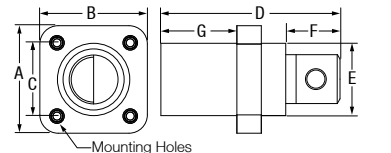

Offset Terminals (Male Shown) Straight Style

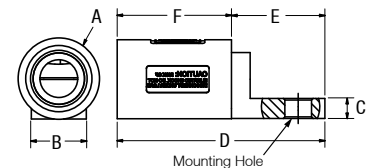

Angled Style

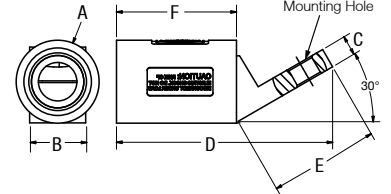

Covers

Description	A	B	C
Weatherproof Cover	2.20" (55.88)	1.16" (29.44)	2.03" (51.5)
Snap Back Cover to be used with receptacles	2.26" (57.4)	2.37" (60.2)	—

Weatherproof Cover

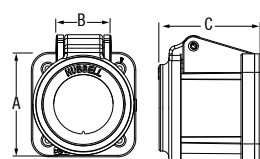

Gender Reversing Devices

Description	A	B	C
Double Male	4.65" (118.1)	1.48" (37.6)	—
Double Female	4.84" (122.9)	1.44" (36.6)	1.06" (27.0)

Gender Reversing - Double Male

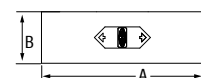

Gender Reversing - Double Female

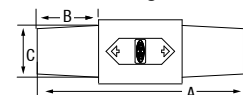

Tees and 3-Fers

Description	A	B	C
Tapping Tee	3.18" (80.8)	4.74" (120.4)	1.48" (37.6)
Paralleling Tee	3.18" (80.8)	4.65" (118.1)	1.48" (37.6)
3-Fer	5.88" (149.3)	5.78" (146.9)	1.48" (37.6)

Tapping Tee

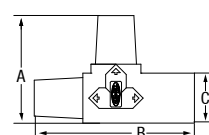

Paralleling Tee

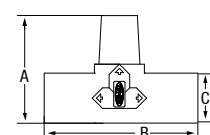

3-Fer

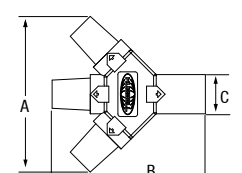

NEC® is a registered trademark of the National Fire Protection Association (NFPA).

Dimensions in Inches (mm)

Single Pole Devices and Temporary Power



Series 18 - 300 and 400 Ampere, 600V AC/250V DC

Enclosure Types
3R, 4X, 12

- Enclosure Types 3R, 4X, 12
- Non-metallic safety retaining screw
- Easy to grip body design
- Accepts #2 to 4/0 AWG wire
- Replacement bodies available
- UL and cULus listed



300A Plugs

Description	Color	Male Plug	Female Plug
Thermoplastic elastomer, cable size #2 - 2/0 AWG.	Black	HBL18300MBK	HBL18300FBK
	White	HBL18300MW	HBL18300FW
	Green	HBL18300MGN	HBL18300FGN
	Red	HBL18300MR	HBL18300FR
	Blue	HBL18300MBL	HBL18300FBL
	Brown	HBL18300MBN	HBL18300FBN
	Orange	HBL18300MO	HBL18300FO
	Yellow	HBL18300MY	HBL18300FY



400A Plugs

Description	Color	Male Plug	Female Plug
Thermoplastic elastomer, cable size 3/0 - 4/0 AWG.	Black	HBL18400MBK	HBL18400FBK
	White	HBL18400MW	HBL18400FW
	Green	HBL18400MGN	HBL18400FGN
	Red	HBL18400MR	HBL18400FR
	Blue	HBL18400MBL	HBL18400FBL
	Brown	HBL18400MBN	HBL18400FBN
	Orange	HBL18400MO	HBL18400FO
	Yellow	HBL18400MY	HBL18400FY



Replacement Bodies (10 Pack)

Description	Color	Male Plug	Female Plug
Thermoplastic elastomer.	Black	HBL18MBBK	HBL18FBBK
	White	HBL18MBW	HBL18FBW
	Green	HBL18MBGN	HBL18FBGN
	Red	HBL18MBR	HBL18FBR
	Blue	HBL18MBBL	HBL18FBBL
	Brown	HBL18MBBN	HBL18FBBN
	Orange	HBL18MBO	HBL18FBO
	Yellow	HBL18MBY	HBL18FBY



Accessories

Description	Catalog Number
Series 18, replacement retaining screw (500 pack).	HBL18RS
Copper foil (500 pack).	HBLCF
Brass wire (500 pack).	HBLBW



Specifications

Electrical	Series 18	
Voltage Ratings	600V AC Maximum 250V DC Maximum	
Amperage Rating	400A Maximum	
Mechanical	300A	400A
Terminal Accommodation	Plug: #2 to 2/0 AWG	Plug: 3/0 to 4/0 AWG
Product ID	Ratings are a permanent part of device	
Base Compound	Thermoplastic Elastomer (TPE)	
Contact Material	Brass	
Retaining Screw Material	Nylon	

Certification / Environmental

Series 18
UL and cULus listed
UL Enclosure Types 3R, 4X, 12
UL 1691 standard for single pole locking-type separable connectors
National Electric Code (NEC), ANSI/NFPA 70
Flammability: HB per UL94 or CSA 22.2. 0.17

Conductor Ampacity Chart (Type SC/PPC Wire)

Cable Size	Ampacity*
#2	190
2/0	300
3/0	350
4/0	405

Note: *90°C column NEC Table 400.5(A)(2).

Dimensions

In Line Plugs

Description	A	B	C	D	E	F
Male	6.77" (172.0)	2.06" (52.3)	1.61" (40.9)	1.85" (47.0)	.73" (18.5)	.38" (TYP) (9.7)
Female	6.21" (157.7)	1.50" (38.1)	1.61" (40.9)	1.85" (47.0)	.73" (18.5)	.38" (TYP) (9.7)

In Line Plug (Male)

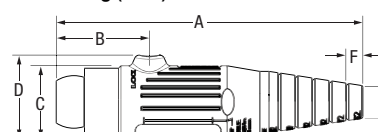

In Line Plug (Female)

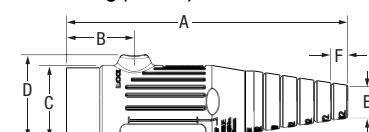

Dimensions in Inches (mm)



Features and Benefits

Spider® II Temporary Power Boxes

Hubbell's Spider® II temporary power distribution system sets the safety and performance standard for temporary power needs. Construction sites and outdoor events place more demands on electrical power than ever before. Hubbell's Spider box steps up to the challenge by offering advanced electrical and safety features. The Spider II box incorporates the most advanced ground fault module technology available in the industry today, ensuring safe and reliable distribution of electrical power for a wide variety of temporary power applications.

Breadth of line and durability, Hubbell manufactures a variety of Spider® II Boxes and temporary power products for both indoor and outdoor power and lighting applications. Hubbell's Spider products incorporate the most innovative wiring devices in the Hubbell Safety-Shroud® Twist-Lock® system. The shrouded Twist-Lock design extends the life of the plug by protecting the blades from abuse and more importantly, the shroud protects the user from arcing.



SBSB1A



Housing Design

- Individual GFCI modules
- Gasketed latching receptacle lift covers
- Replaceable legs



Receptacles

- Six 20 amp straight blade or Twist-Lock® watertight receptacles, individually GFCI protected
- All Pin and Sleeve, Twist-Lock® and straight blade receptacles on each Spider box are protected when not in use by a gasketed, spring loaded flip lid



Safety

- Standard stab termination circuit breakers with gasketed lift cover
- Compact electronic supervisory circuit
- Detailed wiring diagram



Inlets

- Available with flush 50 amp Twist-Lock® inlet or 60 amp IEC reversed service Pin and Sleeve receptacle



Environmental Protection

- Spider® II boxes have earned a Type 3R metallic enclosure rating and heavy duty, abuse resistant legs for outdoor rainproof applications
- Provides UL Type 4X rating when the receptacles are used with Watertight Safety-Shroud® Twist-Lock® plugs



Certifications

- Hubbell's Spider® II Boxes meet NEC® requirements for personal protection against electrical shock on job sites and are listed to the latest UL1640 standard for portable power distribution equipment

NEC® is a registered trademark of the National Fire Protection Association (NFPA).



50A and 60A Spider® II Boxes



50A Spider® II



60A Spider® II



60A Class "L" Spider® II

Spider® II Temporary Power Boxes

Rating	Type	Qty	Receptacle Ratings	Receptacle Components	Protection		Catalog Number
					Overload	GFI	
30A, 120/240V AC (Maximum)	Straight Blade	7	20A, 125V	HBL53R61	Yes	Yes	SDSB1A
	Twist-Lock® (inlet)	1	30A, 120/240V	HBL2715SWR	No	No	
	Twist-Lock® (outlet)	1	30A, 120/240V	HBL2710	No	No	
50A, 120/240V AC (Maximum)	Straight Blade	7	20A, 125V	HBL53R61	Yes	Yes	SBSB1A
	Twist-Lock® (inlet)	1	50A, 125/250V	HBL6375S	No	No	
	Twist-Lock® (outlet)	1	50A, 125/250V	CS6369	No	No	
50A, 120/240V AC (Maximum)	Straight Blade	6	20A, 125V	HBL53R61	Yes	Yes	SBSB2
	Twist-Lock®	1	30A, 250V	HBL2620SW	Yes	Yes	
	Twist-Lock® (inlet)	1	50A, 125/250V	HBL6375S	No	No	
	Twist-Lock® (outlet)	1	50A, 125/250V	CS6369	No	No	
50A, 120/240V AC (Maximum)	Twist-Lock®	7	20A, 125V	HBL2310SW	Yes	Yes	SBTL1A
	Twist-Lock® (inlet)	1	50A, 125/250V	HBL6375S	No	No	
	Twist-Lock® (outlet)	1	50A, 125/250V	CS6369	No	No	
50A, 120/240V AC (Maximum)	Twist-Lock®	6	20A, 125V	HBL2310SW	Yes	Yes	SBTL2
	Twist-Lock®	1	30A, 250V	HBL2620SW	Yes	Yes	
	Twist-Lock® (inlet)	1	50A, 125/250V	HBL6375S	No	No	
	Twist-Lock® (outlet)	1	50A, 125/250V	CS6369	No	No	
60A, 3Ø 120/208V AC (Maximum)	Straight Blade	6	20A, 125V	HBL53R61	Yes	Yes	SCSB0*
	Pin and Sleeve (inlet)	1	60A, 3ØY 120/208V	HBL560B9R	No	No	
	Pin and Sleeve (outlet)	1	60A, 3ØY 120/208V	HBL560R9W	No	No	
60A, 3Ø 120/208V AC (Maximum)	Twist-Lock®	6	20A, 125V	HBL2310SW	Yes	Yes	SCTL0*
	Pin and Sleeve (inlet)	1	60A, 3ØY 120/208V	HBL560B9R	No	No	
	Pin and Sleeve (outlet)	1	60A, 3ØY 120/208V	HBL560R9W	No	No	

Class "L" Spider® II Temporary Power Boxes

Rating	Type	Qty	Receptacle Ratings	Receptacle Components	Protection		Catalog Number
					Overload	GFI	
60A, 3Ø 120/208V AC (Maximum)	Straight Blade	6	20A, 125V	HBL53R61	Yes	Yes**	SCSB0M2
	Class "L" (inlet)	1	60A, 3ØY, 120/208V	—	No	No	
	Class "L" (outlet)	1	60A, 3ØY, 120/208V	—	No	No	
60A, 3Ø 120/208V AC (Maximum)	Twist-Lock®	6	20A, 125V	HBL2310SW	Yes	Yes**	SCTL0M2
	Class "L" (inlet)	1	60A, 3ØY, 120/208V	—	No	No	
	Class "L" (outlet)	1	60A, 3ØY, 120/208V	—	No	No	

Note: *60A units are UL and cUL only.
**GFCI protection on 4 devices only.

Dimensions

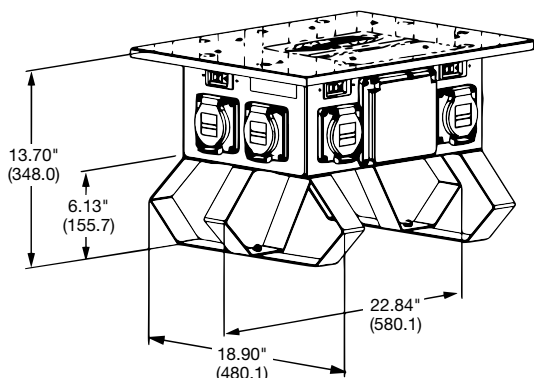

Dimensions in Inches (mm)

Specifications

Spider® II

Listing/Certification	UL1640 cUL and CSA, UL943
Environment	Indoor and outdoor wet and dry locations
Enclosure Type	3R, rainproof, suitable for use in damp locations
Code Compliance	NEC®, ANSI/NFPA 70

NEC® is a registered trademark of the National Fire Protection Association (NFPA).



Features and Benefits

Temporary Power Accessories

Hubbell's SR50 is comprised of a pre-wired 50A receptacle, mounted in a fully non-metallic watertight FD wall box.

This weather resistant, UL listed, assembly provides significant labor savings for the contractor, because it's pre-wired with a 50A Twist-Lock® receptacle, installation time is significantly reduced. The 4 hole mounting pattern of the new FD box also provides added security for the device.



Cable Sets and Receptacles

Description	Catalog Number
50A pre-wired wall mounted receptacle, with 2 ft. wire leads.	SR50
50A cord set - 50 ft. cable (input/output).	SCB50
50A cord set - 100 ft. cable (input/output).	SCB100
60A cord set - 6 ft. cable (input/output).	SCC06
60A cord set - 50 ft. cable (input/output).	SCC50
60A, 3Ø 120/208V Pin and Sleeve wall mounted receptacle.	HBL560R9W
1¼" hub 15 deg. non-metallic angle back box for 60A receptacle.	BB601W
1½" hub 15 deg. metallic 4-way angle back box for 60A receptacle.	FW60100

Note: Consult factory for alternate cable lengths.



SR50



SCB50

Replacement Parts

Description	Catalog Number
20A, 125V straight blade receptacle.	HBL53R61
20A, 125V Safety-Shroud Twist-Lock® receptacle.	HBL2310SW
30A, 250V Safety-Shroud Twist-Lock® receptacle.	HBL2620SW
30A, 125/250V Reverse Service Safety-Shroud connector.	HBL2713SR
30A, 125/250V Reverse Service inlet.	HBL2715SWR
50A, 125/250V Twist-Lock® receptacle.	CS6369
50A, 125/250V Twist-Lock® inlet.	HBL6375S
60A, 3Ø 120/208V Pin and Sleeve reversed service receptacle (inlet).	HBL560B9R
60A, 3Ø 120/208V Pin and Sleeve receptacle (outlet).	HBL560R9W
60A, 3Ø 120/208V Pin and Sleeve reversed service plug (female).	HBL560P9WR
60A, 3Ø 120/208V Pin and Sleeve plug (male).	HBL560P9W
GFCI module.	GFM20
50A Spider supervisory kit.	SSK
60A Spider supervisory kit.	SSK60
Spider circuit breaker cover.	SCBC
Spider leg kit.	SLK
Spider leg kit, green.	SLKG
50A receptacle cover plate.	HBL77CM74WO



HBL560R9W



HBL2310SW



SCBC



GFM20



SSK



HBL77CM74WO



CS6369



HBL2713SR



Features and Benefits

Temporary Power Distribution Boxes and Temporary Power Cables

- Durable hi-visibility yellow powder coated steel construction
- Hubbell 50 amp Twist-Lock® receptacle and inlet
- Six 20 amp straight blade or Twist-Lock® covered receptacles
- Individual GFCI modules
- NEMA 3R enclosure
- Nesting leg design saves space in the warehouse and on the truck



TPDL – Twist-Lock®
TPDS – Straight Blade



TPC50 – 50' Cable
TPC100 – 100' Cable



HBLCGFM20

Temporary Power Distribution Boxes

Rating	Type	Qty	Receptacle Rating	Protection		Catalog Number
				Overload	GFI	
50A, 120/240V AC (Maximum)	Twist-Lock®	6	20A, 125V	Yes	Yes	TPDL
	Twist-Lock®	1	30A, 250V	Yes	No	
	Twist-Lock® (Inlet)	1	50A, 125/250V	No	No	
	Twist-Lock® (Outlet)	1	50A, 125/250V	No	No	
50A, 120/240V AC (Maximum)	Straight Blade	6	20A, 125V	Yes	Yes	TPDS
	Twist-Lock®	1	30A, 250V	Yes	No	
	Twist-Lock® (Inlet)	1	50A, 125/250V	No	No	
	Twist-Lock® (Outlet)	1	50A, 125/250V	No	No	
Replacement GFCI module.						HBLCGFM20

Temporary Power Cables

Rating	CableType	Length	Male Device	Female Device	Weatherproof	Catalog Number
					Boot	
50A, 125/250V	6/3, 8/1	50 ft.	CS6365L	CS6364L	No	TPC50
50A, 125/250V	6/3, 8/1	100 ft.	CS6365L	CS6364L	No	TPC100

Specifications

Boxes	
Listings/Certifications	UL1640, UL943
Operation	Indoor and outdoor wet and dry locations
Enclosure Type	3R, rainproof, suitable for use in damp locations
Code Compliance	NEC®, ANSI/NFPA 70

Cables	
Listings/Certifications	Connectors: UL/CSA; Cable: MSHA
Operation	Indoor and outdoor wet and dry locations

Dimensions

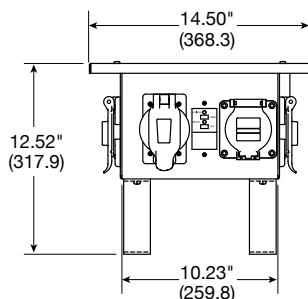

Dimensions in Inches (mm)

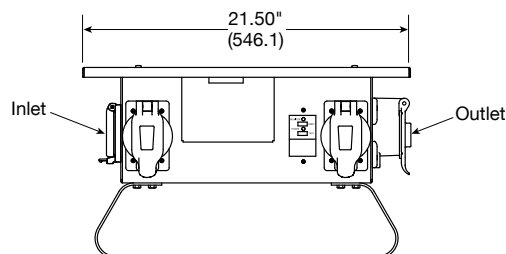

NEC® is a registered trademark of the National Fire Protection Association (NFPA).

Heavy-Duty Portable Outlet Boxes and Cover Plates

Description	Catalog Number
Box with cord strain relief, with one blank cover plate.	HBLPOB1
Box with cord strain relief, with one blank cover plate, black.	HBLPOB1BK
Box with cord strain relief, with two duplex (indoor) cover plates.	HBLPOB1D
Box with cord strain relief, with two duplex (indoor), yellow cover plates.	HBLPOB1DY
Blank, non-metallic FS cover plate with foam gasket, gray.	HBLP14FS
Duplex, non-metallic FS cover plate, gray.	HBLP8FS
Duplex, non-metallic FS cover plate, yellow.	HBLP8FSY
Single receptacle (1.39"), non-metallic FS cover plate, gray.	HBLP7FS
Single receptacle (1.56"), non-metallic FS cover plate, gray.	HBLP720FS
Rectangular opening, non-metallic FS cover plate, gray.	HBLP26FS



HBLPOB1

Other Cover Plates and Devices

which may be used with Heavy-Duty Portable Outlet Boxes

Description	Catalog Number
Duplex cover plate, weatherproof.	HBL5221, HBL52CM21
Single receptacle (1.39") cover plate, weatherproof.	HBL7423WO, HBL74CM23WO
Single receptacle (1.56") cover plate, weatherproof.	HBL7425WOA, HBL74CM25WOA
Safety-Shroud Twist-Lock® surface receptacles.	HBL2310SR, HBL2320SR, HBL2330SR, HBL2610SR, HBL2620SR



Cover Plates

Note: Standard product gray, CM yellow.

Deluxe Cord Grips Straight Male Thread Nylon Fittings, Stainless Steel Mesh, Liquidtight, for Insulated Cables

Grip Diameter Range Inches (mm)	Thread Size NPT (inches)	Form Size	Catalog Number
.375"-.500" (9.5-12.7)	3/4"	F3	074011335
.500"-.625" (12.7-15.9)	3/4"	F3	074011336
.625"-.750" (15.9-19.0)	3/4"	F3	074011337

Gray Nylon Cord Connector Straight Male Thread

Grip Diameter Range Inches (mm)	Thread Size NPT (inches)	Form Size	Catalog Number
.375"-.500" (9.5-12.7)	3/4"	F3	SHC1035CR
.500"-.625" (12.7-15.9)	3/4"	F3	SHC1036CR
.625"-.750" (15.9-19.0)	3/4"	F3	SHC1037CR



**Deluxe Cord Grips
(purchased separately)**

Specifications for Heavy-Duty Portable Outlet Boxes and Cover Plates

UL Listed	UL514C, UL467 and UL50 Enclosures Types 1, 3R.
CSA Certified	C22.2 No. 18 and C22.2 No. 94 Enclosures Types 1, 3R and C22.2 No. 0.4 (Impedance).
Box Specifications:	
Moisture Resistance	Wet and damp locations, enclosure Type 3R when used with weatherproof cover plates; Dry, indoors locations, enclosure Type 1 with all other cover plates
Flammability	UL94V-0, 94-5VA classification
Operating Temperature	80°C maximum; -35°C minimum
UV Resistance	All materials are UV stabilized
Impact and Crush Resistance	In accordance with UL514C, UL50, C22.2 No. 18 and C22.2 No. 94
Material	Valox®
Cord Connector Materials	Nylon nut; nylon Gotcha® ring; neoprene grommet
Cord Diameter Range	.38" to .75" diameter
Bonding Strap Material	Brass
Threaded Inserts	Brass
Grounding Screw Material	Brass
Indoor Cover Plate Screws Material	Zinc plated steel
Outdoor Cover Plate Screws Material	Stainless steel
Cover Plate Gasket Material	UL recognized closed-cell foam (aging and oil resistant)



**Gray Nylon
Cord Connector**

Dimensions

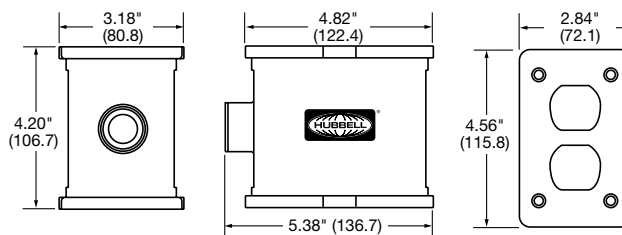

HBLPOB1

Valox® is a trademark of SABIC Innovative Plastics, acquired from General Electric Company.

Dimensions in Inches (mm)



Construction Site Lighting

Hubbell's outdoor approved construction site lighting line includes both heavy duty metal halide lights and light strings for working in rugged environments. The metal halide fixtures feature extremely strong and compact heads with bulbs rated to last 10,000 hours. All frames are powder-coated yellow for safety and are constructed of a durable 1.25 inch, 12 gauge steel tube.

We have light strings for all applications in a variety of models as well as a choice of metal or plastic guards. Light sockets are spaced 10 feet apart and all sockets, plugs, and connectors are molded for added durability. In addition, the highly impact-resistant material makes for easy transportation and storage when not in use. Bulbs can be incandescent, fluorescent or LED. Consider choosing LED lighting for a durable bulb that saves energy, provides instant illumination and are rated to last 50,000 hours.



HBLMH1000



HBLMH400



HBLLEDHB120



HBL182S50LEDH



HBL143SJ100PS



HBLFS2549
Straps not Shown

Metal Halide and LED Lights

Description	Rating	Watts	Lumen Output	Cord Length	Catalog Number
5 -10 ft. metal halide cart light with portable detachable ballast.	15A 125V	1,000	110,000	—	HBLMH1000
6 -12 ft. metal halide cart light.	15A 125V	2,000	220,000	—	HBLMH2000
High bay metal halide light with wire guard.	15A 125V	400	29,000	3 ft.	HBLMH400
High bay LED light with wire guard.	15A 125V	120	14,000	5 ft.	HBLLEDHB120

LED Stringer Lights

Description	No. of Fixtures	Rating	Cord Type	Lumen Output	Cord Length	Catalog Number
90 LEDs per fixture, light string with magnetic base included.	1	15A 125V	#18/2 SJTW	450*	20 ft.	HBL182S20LED
90 LEDs per fixture, light string.	5	15A 125V	#18/2 SJTW	450*	50 ft.	HBL182S50LED
	10	15A 125V	#18/2 SJTW	450*	100 ft.	HBL182S100LED
60 LEDs per fixture, light string with magnetic base included.	1	15A 125V	#18/2 SJTW	1,100*	20 ft.	HBL182S20LEDH
	5	15A 125V	#18/2 SJTW	1,100*	50 ft.	HBL182S50LEDH
28W High power LED light string with inline ON/OFF switch.	—	15A 125V	#16 AWG SJTOW	2,928	6 ft.	HBLLS2834
Magnetic clip bracket for LED.	—	—	—	—	—	HBLSTMC

Note: *Lumens per fixture.

A Type (Edison) Twist-Lock® and Straight Blade Light Strings

Description	Max Watts**	Rating	Cord Type	Fixtures	Cord Length	Catalog Number
Twist-Lock® light string; plastic guards.	150	20A 125V	#12/3 STW	10	100 ft.	HBL123S100PT
	150	20A 125V	#12/3 STJW	10	100 ft.	HBL123SJ100PT
Twist-Lock® light string; metal guards.	150	20A 125V	#12/3 STW	10	100 ft.	HBL123S100MT
Straight Blade light string; plastic guards.	150	15A 125V	#14/2 STJW	10	100 ft.	HBL142SJ100PS
	150	15A 125V	#14/3 STJW	10	100 ft.	HBL143SJ100PS
Straight Blade light string; metal guards.	150	15A 125V	#12/3 STW	10	100 ft.	HBL123S100PS
	150	15A 125V	#12/3 STJW	10	100 ft.	HBL123SJ100PS
Straight Blade light string; plastic guards.	150	15A 125V	#12/3 STW	10	100 ft.	HBL123S100MS
	150	15A 125V	#12/3 STW	5	50 ft.	HBL123S50PS
Straight Blade light string; metal guards.	150	15A 125V	#12/3 STW	5	50 ft.	HBL123S50MS
	—	—	—	—	—	HBLSTPG
Replacement heavy duty metal guard for temporary light strings.	—	—	—	—	—	HBLSTMG

Note: **Max watts per fixture. **HBL143SJ100PS** light strings are rated for 1875 Watts total. The total wattage must be considered when daisy chaining lights strings to each other.

Fluorescent Light Strings

Description	Wattage	Rating	Cord Type	Lumen Output	Cord Length	Catalog Number
Fluorescent light string, 34.5" single fixture with hanging straps	50	15A 125V	#16 AWG SJTOW	3,750	6 ft.	HBLFS5035
Fluorescent light string, 48.5" single fixture with hanging straps	25	15A 125V	#16 AWG SJTOW	2,125	6 ft.	HBLFS2549



LED Maintenance Worklights

Description	Outlet Rating	Rating	Wattage	Lumen Output	Cord Type	Cord Length	Catalog Number
LED Industrial maintenance light, 1 vertical hanging hook included.	N/A	15A 125V	20	2400	#16/3 SJEOW	25 ft.	HBLML2825L
LED worklight with end light feature.	N/A	15A 125V	9	920/120	#18/2 SJTOW	25 ft.	HBLWL25LED
LED worklight with end light feature and tool tap.	12 Amp	15A 125V	9	920/120	#16/3 SJTOW	25 ft.	HBLWL25LEDT



Fluorescent Maintenance Worklights

Description	Outlet Rating	Rating	Wattage	Lumen Output	Cord Type	Cord Length	Catalog Number
Fluorescent worklight with straight blade plug.	N/A	15A 125V	13	825	#16/3 SJTOW	25 ft.	TW25F1
Fluorescent worklight with Twist-Lock® plug and tool tap.	12 Amp	20A 125V	13	825	#16/3 SJTOW	25 ft.	TW25F2
Fluorescent maintenance light, 34.5 in., one vertical hanging hook included.	N/A	15A 125V	50	3750	#16/3 SJEOW	25 ft.	HBLML5025
Fluorescent maintenance light, 48.5 in.	N/A	15A 125V	25	2125	#16/3 SJEOW	25 ft.	HBLML2525
Fluorescent worklight, 45 in., 2 horizontal plastic hangers, 1 attached metal hanging hook included.	N/A	15A 125V	25	2125	#16/3 SJTOW	25 ft.	HBLWL2525



Accessories and Replacement Items

Description	Catalog Number
Magnetic mounting bracket for ML style lights, 82 lb. capacity.	HBLMLMM
Magnetic mounting bracket for WL style lights, 58 lb. capacity.	HBLWLMM
Replacement rough service fluorescent bulb for 13 watt style lamps.	HBLREPPFB
Metal halide replacement bulb, 400 watts.	HBLREP400MH
Metal halide replacement bulb, 1,000 watts.	HBLREP1000MH
Replacement LED panel fixture, 90 LEDs, 450 lumen.	HBLREP450LED
5 base LED string only, 50 ft., 18/2.	HBLREP182S50
10 base LED string only, 100 ft., 18/2.	HBLREP182S100



HBLMLMM



HBLWLMM



HBLREPPFB



HBLREP400MH



HBLREP1000MH

Explosion Proof/Confined Space Lighting

Hazardous Location Lights

Description	Wattage	Lumen Output	Cord Type	Cord Length	Catalog Number
Fluorescent, Class 1, Div 1 Groups C & D, Class 2, Div 1 Groups F & G, 12V, inline transformer.	26	1800	#16/3 SOW	60 ft.	HBLXF6012V
Incandescent, Class 1, Div 1, Groups C & D, 12V, inline transformer.	75	720	#16/3 SOW	60 ft.	HBLXI6012V
Fluorescent, Class 1, Div 1 Groups C & D, Class 2, Div 1 Groups F & G, 120V, less plug.	26	1800	#16/3 SOW	50 ft.	HBLXF50120V
Incandescent, Class 1, Div 1 Groups C & D, 120V less plug.	100	1230	#16/3 SOW	50 ft.	HBLXI50120V
Fluorescent, non-explosion proof, wet location, 12V, inline transformer.	13	825	#18/2 SJTOW	60 ft.	HBLWT6012V





Pre-Wired Portable Outlet Boxes, Worklights and Accessories



SPB1

Pre-Wired Portable Outlet Boxes

Description	Catalog Number
25 ft. with 2-15A, 125V, straight blade single receptacles and 1-15A, 125V straight blade plug and boot.	SPB1
25 ft. with 2-20A, 125V, Twist-Lock® single receptacles and 1-20A, 125V Twist-Lock® plug and boot.	SPB2



SPB2

Worklights and Accessories

Description	Catalog Number
Temporary low voltage worklight with cigarette lighter plug, 20 ft. cord.	TWLV20F
Non-metallic temporary worklight hook.	TWH

Specifications

Temporary Worklights

Listing/Certification	UL298 and cUL portable electric hand lamps
Environment	Dry, indoor locations
Fluorescent Lamp	13 watt twin tube only

Battery Pack and Charger

Environment	Indoor and outdoor dry locations
Fluorescent Lamp Life	Fully charged-5 hour approx
Charge Time	Fully charged-16 hours approx
Battery Rating	12 volt



TWLV20F



TWH

Light Fixture

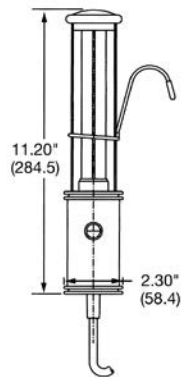

Worklight Hook

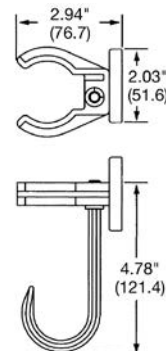

Dimensions in Inches (mm)