

# Power Inductors

## Model HA72L-1770 series

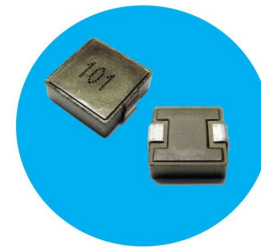

### Features:

- Operating Temperature Range  $-55^{\circ}\text{C}$  to  $+155^{\circ}\text{C}$
- Ambient Temperature, Maximum  $+115^{\circ}\text{C}$
- Temperature Rise,  $40^{\circ}\text{C}$
- RoHS Compliant
- AEC-Q200 Certified

All parts are Pb-free and comply with EU Directive 2011/65/EU (RoHS2)

### Schematic

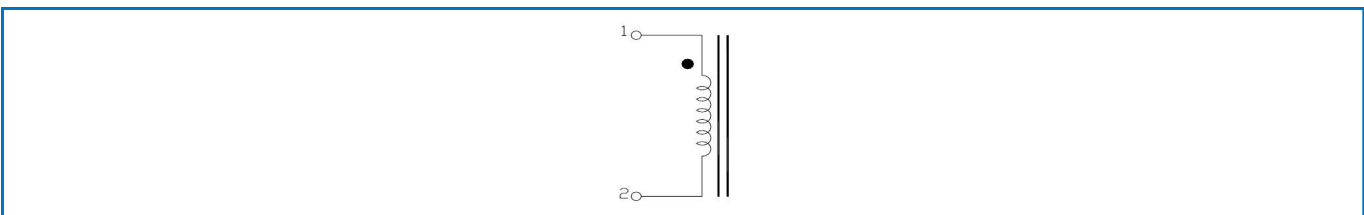

### Specifications @ $25^{\circ}\text{C}$

Part Number	Inductance ( $\mu\text{H} \pm 20\%$ @0A)	DCR (m $\Omega$ ) Typ	DCR (m $\Omega$ ) Max	I <sub>rms</sub> (A)	I <sub>sat</sub> (A)	Part Number	Inductance ( $\mu\text{H} \pm 20\%$ @0A)	DCR (m $\Omega$ ) Typ.	DCR (m $\Omega$ ) Max	I <sub>rms</sub> (A)	I <sub>sat</sub> (A)
HA72L-1770R82LFTR	0.82	0.98	1.08	56.5	45.0	HA72L-1770100LFTR	10.0	8.89	9.33	19.0	17.0
HA72L-17701R0LFTR	1.00	1.21	1.27	55.5	32.0	HA72L-1770150LFTR	15.0	13.70	14.40	14.0	12.0
HA72L-17701R5LFTR	1.50	1.54	1.62	48.0	31.0	HA72L-1770220LFTR	22.0	20.00	21.00	12.0	9.5
HA72L-17702R2LFTR	2.20	1.85	1.98	43.5	28.0	HA72L-1770330LFTR	33.0	35.10	37.00	10.7	9.0
HA72L-17703R3LFTR	3.30	2.79	2.93	35.0	27.0	HA72L-1770470LFTR	47.0	40.70	42.70	8.7	8.6
HA72L-17704R7LFTR	4.70	3.98	4.18	30.0	21.0	HA72L-1770560LFTR	56.0	55.00	57.80	7.2	4.2
HA72L-17705R6LFTR	5.60	4.23	4.44	28.0	21.0	HA72L-1770680LFTR	68.0	72.10	75.70	6.1	4.5
HA72L-17706R8LFTR	6.80	5.86	6.15	22.5	18.5	HA72L-1770820LFTR	82.0	87.30	91.70	5.5	4.5
HA72L-17708R2LFTR	8.20	7.71	8.10	21.0	18.0	HA72L-1770101LFTR	100.0	105.0	110.0	5.0	4.0

- Notes: (1) I<sub>sat</sub> is the saturation current at which inductance rolls off approximately 30% from its initial (zero DC)  
 (2) I<sub>rms</sub> is the approximate current at which  $\Delta T = 40^{\circ}\text{C}$   
 (3) Operating Temperature Range  $-55^{\circ}\text{C}$  to  $+155^{\circ}\text{C}$

### General Note

TT Electronics reserves the right to make changes in product specification without notice or liability. All information is subject to TT Electronics' own data and is considered accurate at time of going to print.

TT Electronics | BI Technologies  
 A-1445, Jalan Tanjung Api

25050 Kuantan Pahang Darul Makmur, Malaysia | Ph: +60 9 565 8888  
[www.ttelectronicsmagnetics.com/customer-service-enquiry](http://www.ttelectronicsmagnetics.com/customer-service-enquiry)

### Electrical Characteristics @ 25°C

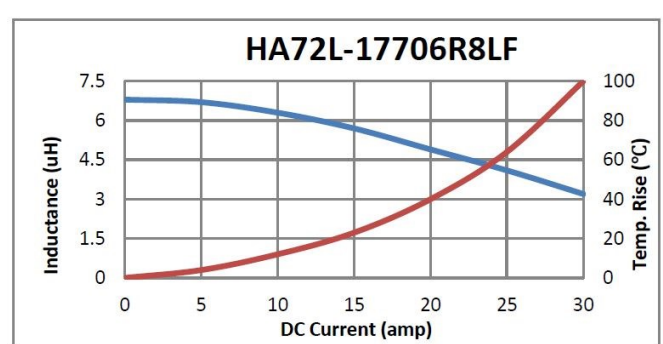
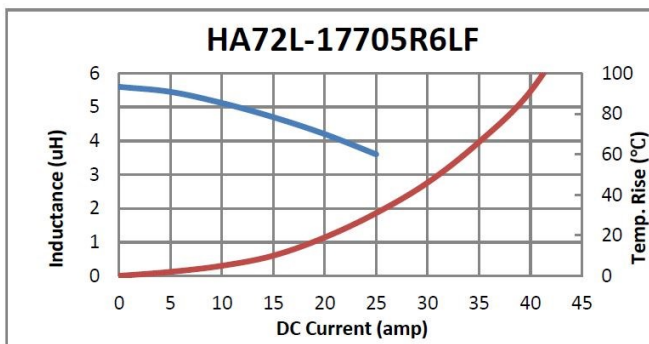
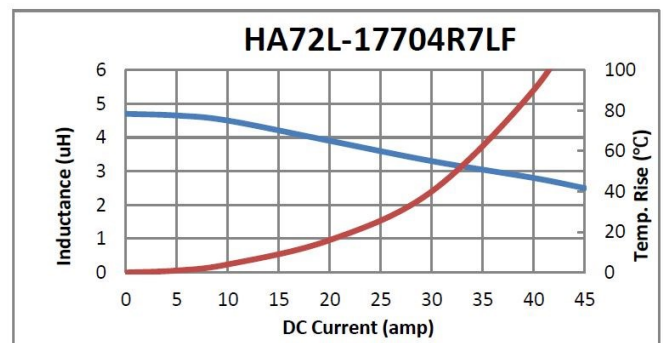
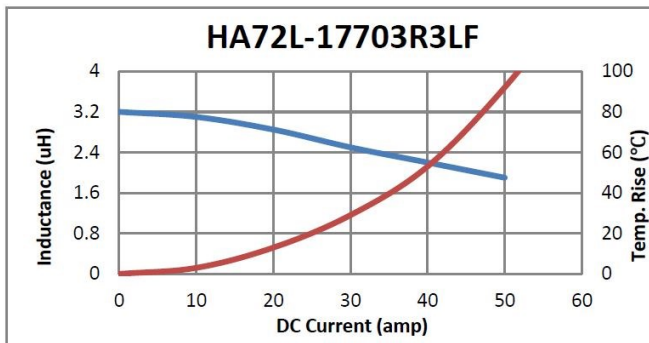
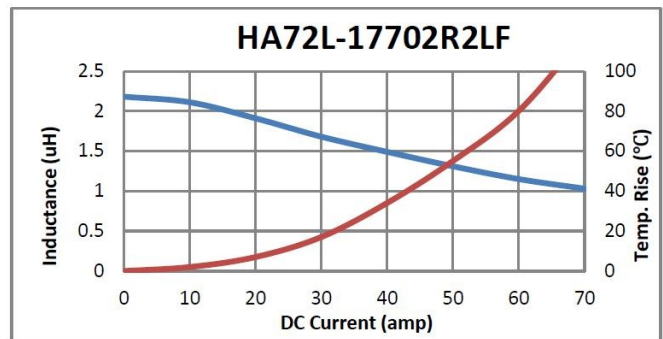
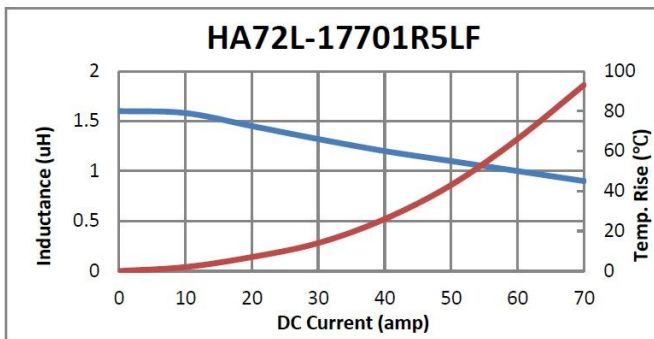
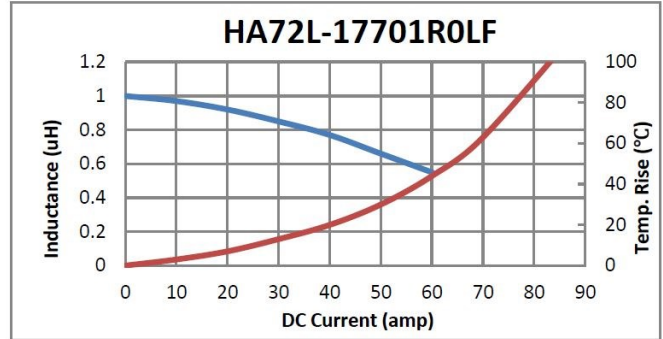
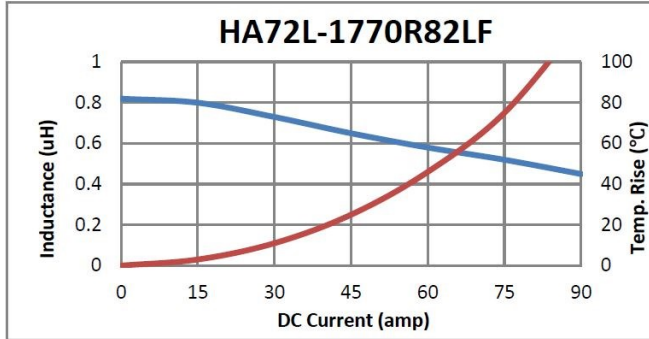

General Note  
 TT Electronics reserves the right to make changes in product specification without notice or liability. All information is subject to TT Electronics' own data and is considered accurate at time of going to print.

TT Electronics | BI Technologies  
 A-1445, Jalan Tanjung Api  
 25050 Kuantan Pahang Darul Makmur, Malaysia | Ph: +60 9 565 8888  
[www.ttelectronicsmagnetics.com/customer-service-enquiry](http://www.ttelectronicsmagnetics.com/customer-service-enquiry)

### Electrical Characteristics @25°C

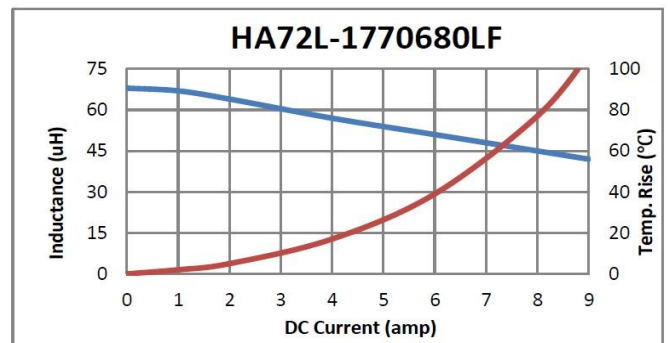
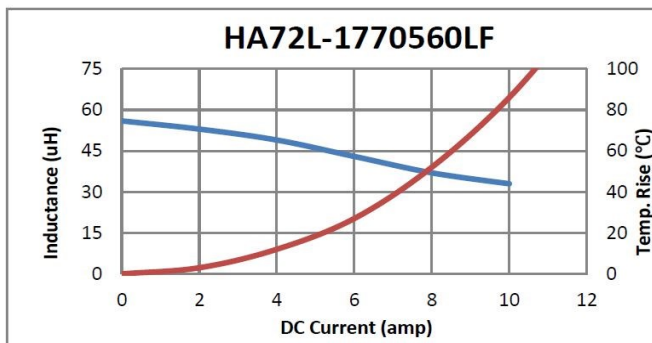
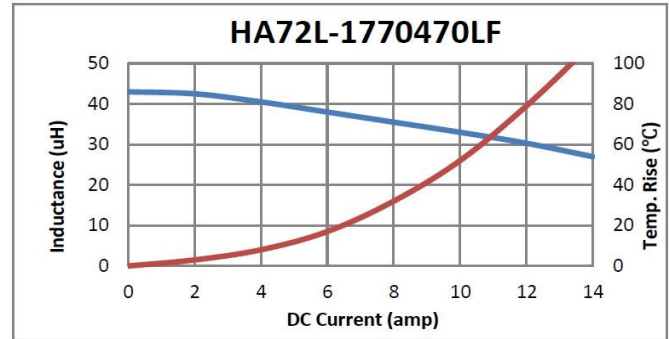
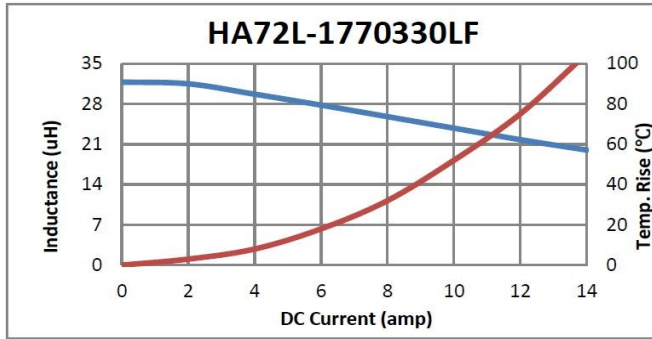
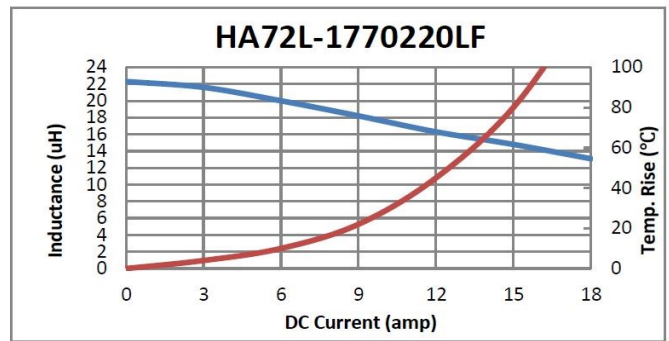
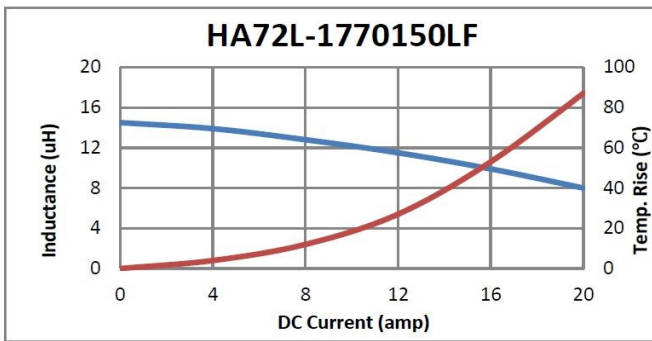
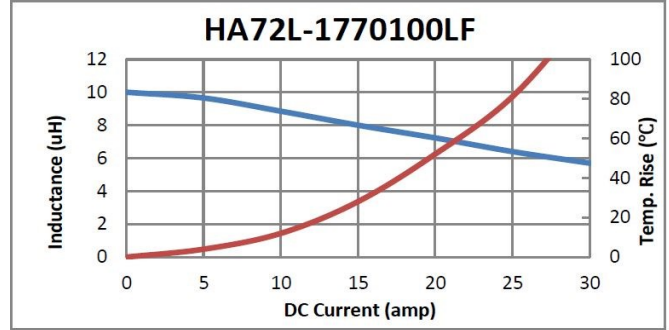
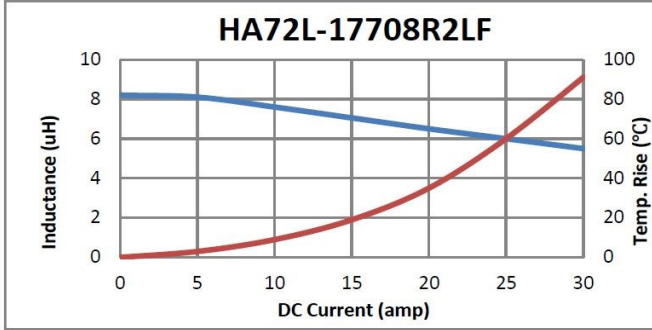

General Note  
 TT Electronics reserves the right to make changes in product specification without notice or liability. All information is subject to TT Electronics' own data and is considered accurate at time of going to print.

TT Electronics | BI Technologies  
 A-1445, Jalan Tanjung Api  
 25050 Kuantan Pahang Darul Makmur, Malaysia | Ph: +60 9 565 8888  
[www.ttelectronicsmagnetics.com/customer-service-enquiry](http://www.ttelectronicsmagnetics.com/customer-service-enquiry)

# Power Inductors

## Model HA72L-1770 series

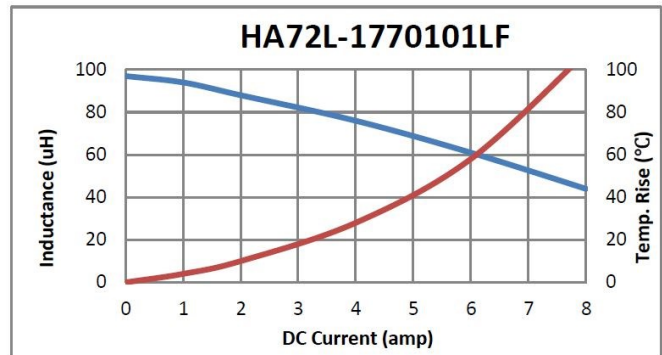
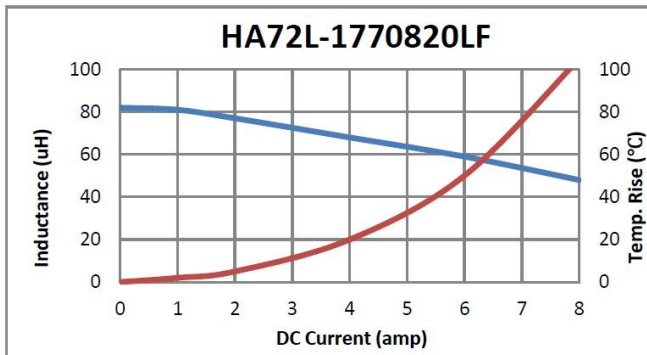

### Outline dimensions (mm)

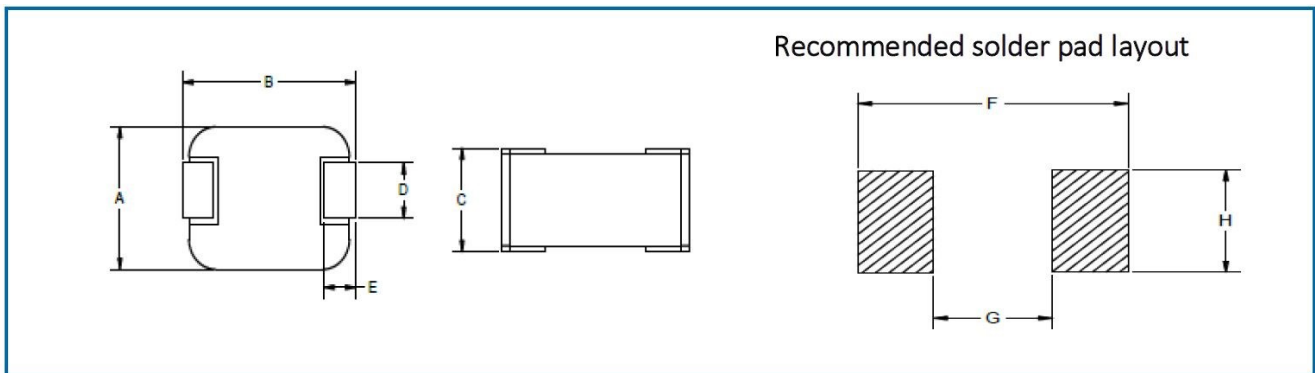

CASE SIZE	A(mm)	B(mm)	C(mm)	D(mm)	E(mm)	F(mm)	G(mm)	H(mm)
1770 series	17.15 Max	18.0 ± 0.3	7	11.94 ± 0.3	2.7 ± 0.4	18.03	11.68	12.09

### Packaging

Standard:	Embossed Tape and Reel		
	Reel:	Diameter	All case size = 13" (330mm)
		Capacity	Case size 1770 = 150 units

General Note  
 TT Electronics reserves the right to make changes in product specification without notice or liability. All information is subject to TT Electronics' own data and is considered accurate at time of going to print.

TT Electronics | BI Technologies  
 A-1445, Jalan Tanjung Api  
 25050 Kuantan Pahang Darul Makmur, Malaysia | Ph: +60 9 565 8888  
[www.ttelectronicsmagnetics.com/customer-service-enquiry](http://www.ttelectronicsmagnetics.com/customer-service-enquiry)

## Ordering information

