

# Power Inductors

## Model HA72L-1250 series



### Features:

- Operating Temperature Range  $-55^{\circ}\text{C}$  to  $+155^{\circ}\text{C}$
- Ambient Temperature, Maximum  $+115^{\circ}\text{C}$
- Temperature Rise,  $40^{\circ}\text{C}$
- RoHS Compliant
- AEC-Q200 Certified

 All parts are Pb-free and comply with EU Directive 2011/65/EU (RoHS2)

### Schematic

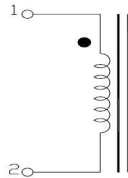

### Specifications @ $25^{\circ}\text{C}$

Part Number	Inductance ( $\mu\text{H} \pm 20\%$ @0A)	DCR (m $\Omega$ ) Typ	DCR (m $\Omega$ ) Max	Irms (A)	Isat (A)	Part Number	Inductance ( $\mu\text{H} \pm 20\%$ @0A)	DCR (m $\Omega$ ) Typ.	DCR (m $\Omega$ ) Max	Irms (A)	Isat (A)
HA72L-1250R10LFTR	0.10	0.53	0.60	55.0	80	HA72L-12502R7LFTR	2.70	5.70	6.80	18.0	32.0
HA72L-1250R22LFTR	0.22	0.64	0.80	51.0	80	HA72L-12503R3LFTR	3.30	7.70	9.20	15.0	32.0
HA72L-1250R33LFTR	0.33	0.85	1.20	42.0	80	HA72L-12504R7LFTR	4.70	12.80	15.00	12.0	27.0
HA72L-1250R47LFTR	0.47	1.10	1.30	38.0	65.0	HA72L-12505R6LFTR	5.60	14.00	16.50	11.5	22.0
HA72L-1250R56LFTR	0.56	1.30	1.60	36.0	55.0	HA72L-12506R8LFTR	6.80	15.40	18.50	11.0	21.0
HA72L-1250R68LFTR	0.68	1.50	1.70	34.0	54.0	HA72L-12507R8LFTR	7.80	17.20	20.50	10.0	18.0
HA72L-1250R82LFTR	0.82	2.00	2.30	31.0	53.0	HA72L-12508R2LFTR	8.20	18.90	22.50	9.5	18.0
HA72L-12501R0LFTR	1.00	2.10	2.50	29.0	50.0	HA72L-1250100LFTR	10.0	21.40	25.50	9.0	16.0
HA72L-12501R2LFTR	1.20	2.80	3.50	25.0	49.0	HA72L-1250150LFTR	15.0	44.00	48.00	6.0	9.0
HA72L-12501R5LFTR	1.50	3.40	4.10	23.0	38.0	HA72L-1250220LFTR	22.0	50.00	58.00	5.5	8.0
HA72L-12501R8LFTR	1.80	4.20	4.90	19.0	35.0	HA72L-1250330LFTR	33.0	75.00	84.00	3.5	6.0
HA72L-12502R2LFTR	2.20	4.60	5.50	20.0	32.0	HA72L-1250470LFTR	47.0	138.00	152.00	2.0	4.0

- Notes: (1) Isat is the saturation current at which inductance rolls off approximately 30% from its initial (zero DC)  
 (2) Irms is the approximate current at which  $\Delta T = 40^{\circ}\text{C}$   
 (3) Operating Temperature Range  $-55^{\circ}\text{C}$  to  $+155^{\circ}\text{C}$

### General Note

TT Electronics reserves the right to make changes in product specification without notice or liability. All information is subject to TT Electronics' own data and is considered accurate at time of going to print.

TT Electronics | BI Technologies  
 A-1445, Jalan Tanjung Api

25050 Kuantan Pahang Darul Makmur, Malaysia | Ph: +60 9 565 8888  
[www.ttelectronicsmagnetics.com/customer-service-enquiry](http://www.ttelectronicsmagnetics.com/customer-service-enquiry)

### Electrical Characteristics

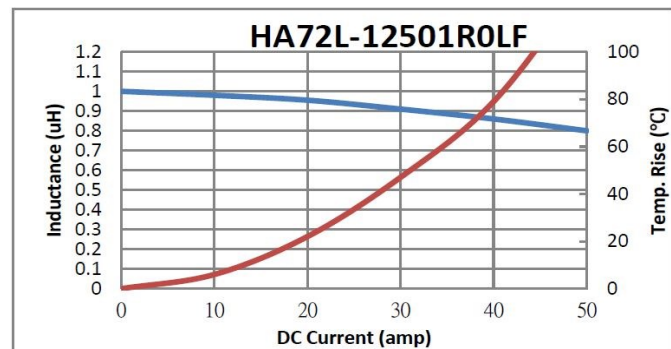
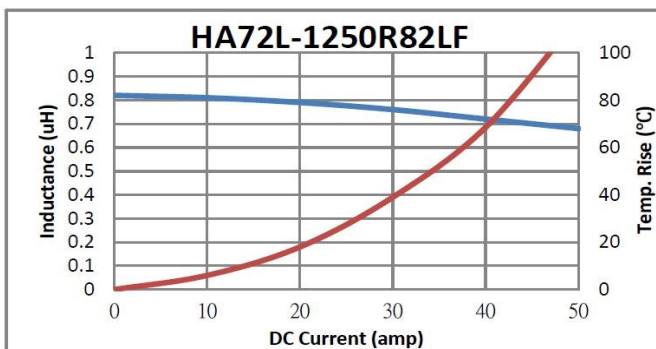
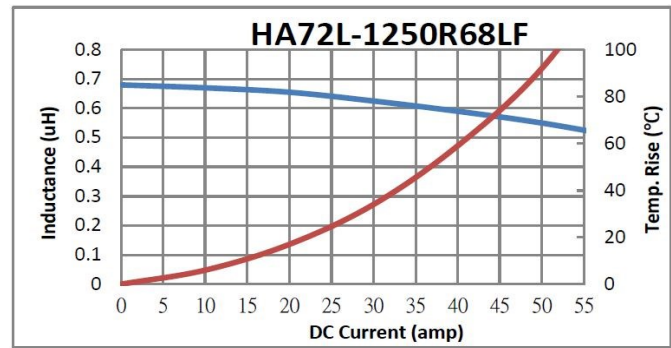
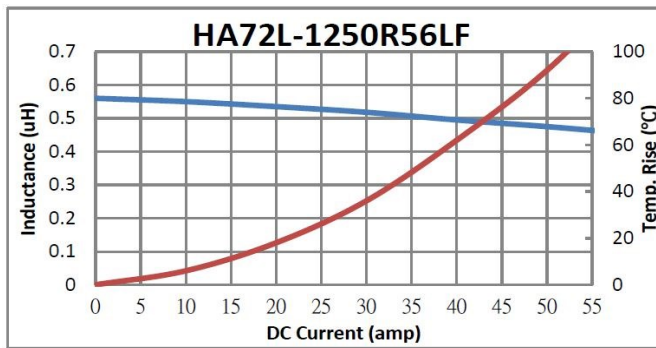
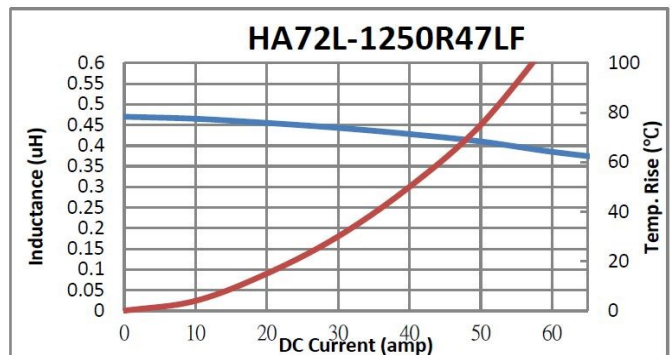
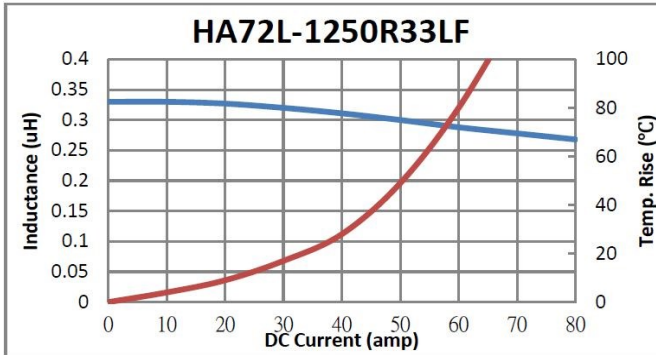
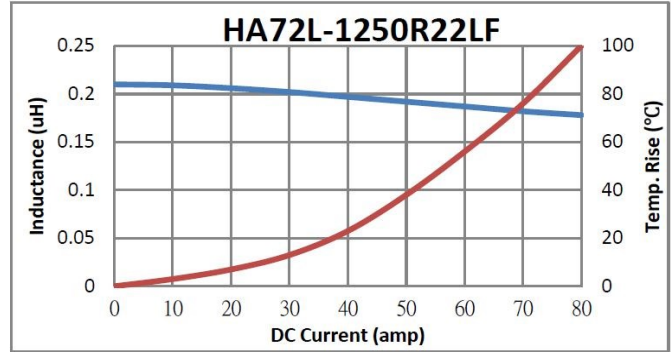
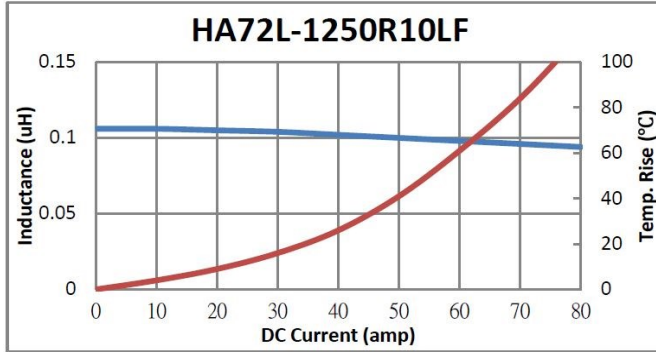

General Note  
 TT Electronics reserves the right to make changes in product specification without notice or liability. All information is subject to TT Electronics' own data and is considered accurate at time of going to print.

TT Electronics | BI Technologies  
 A-1445, Jalan Tanjung Api  
 25050 Kuantan Pahang Darul Makmur, Malaysia | Ph: +60 9 565 8888  
[www.ttelectronicsmagnetics.com/customer-service-enquiry](http://www.ttelectronicsmagnetics.com/customer-service-enquiry)

### Electrical Characteristics

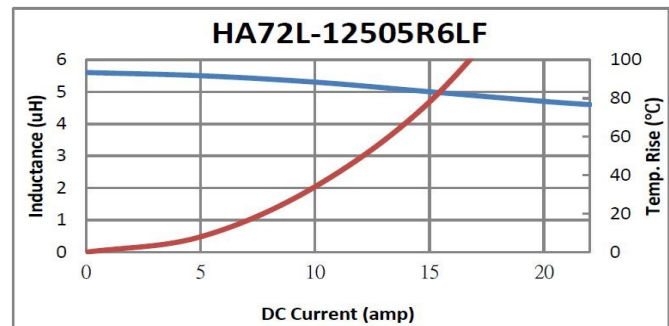
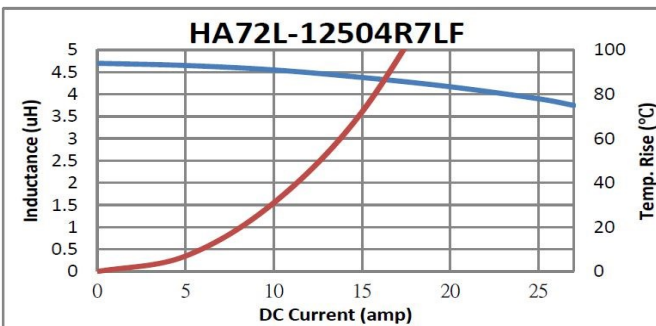
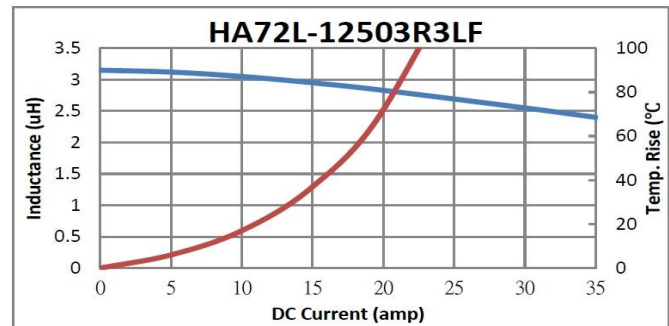
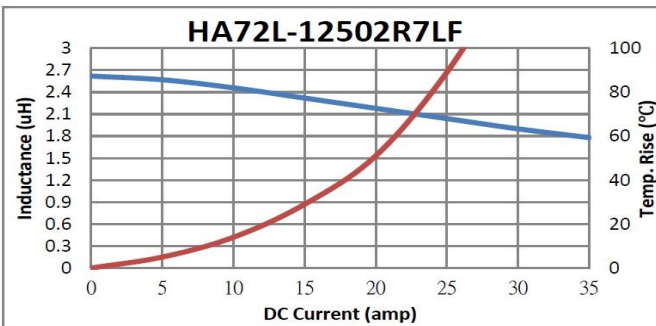
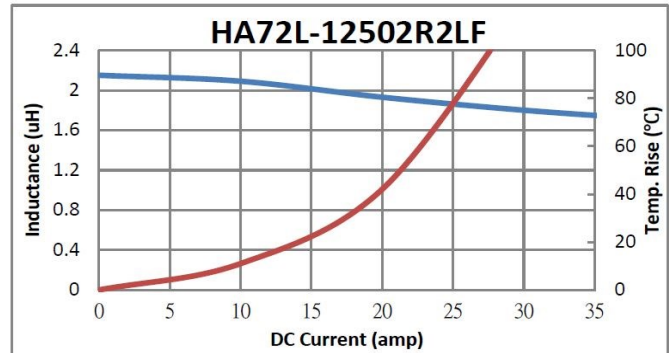
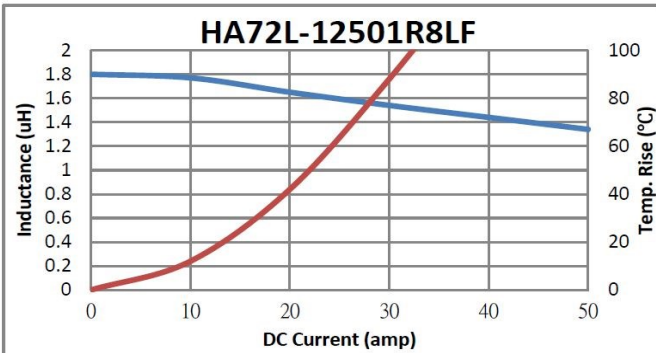
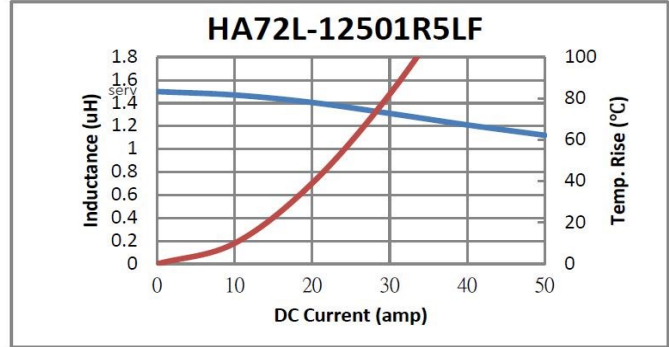
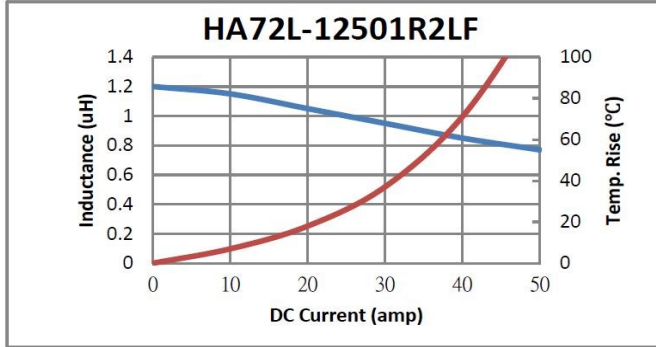

General Note  
 TT Electronics reserves the right to make changes in product specification without notice or liability. All information is subject to TT Electronics' own data and is considered accurate at time of going to print.

TT Electronics | BI Technologies  
 A-1445, Jalan Tanjung Api  
 25050 Kuantan Pahang Darul Makmur, Malaysia | Ph: +60 9 565 8888  
[www.ttelectronicsmagnetics.com/customer-service-enquiry](http://www.ttelectronicsmagnetics.com/customer-service-enquiry)

### Electrical Characteristics

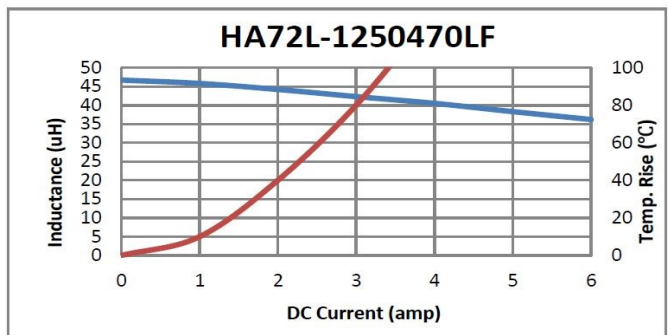
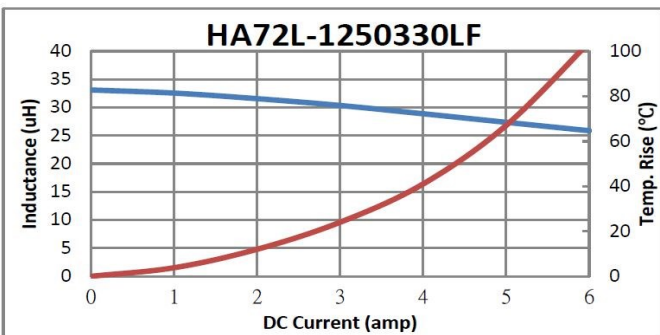
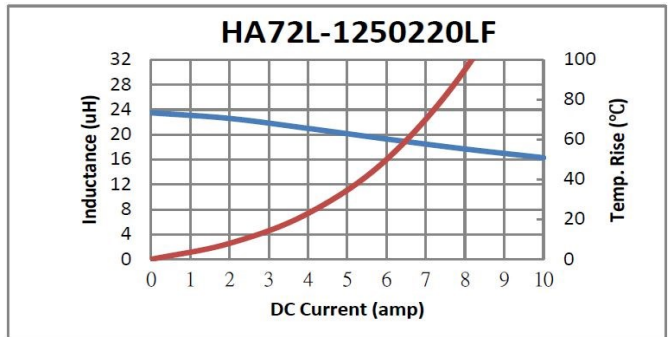
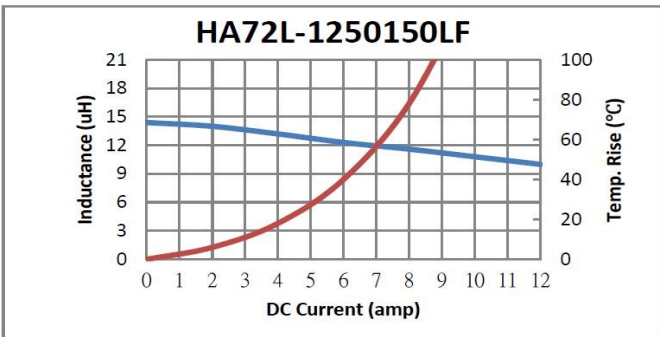
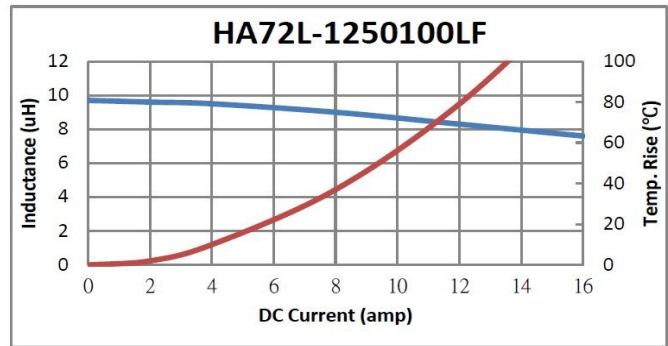
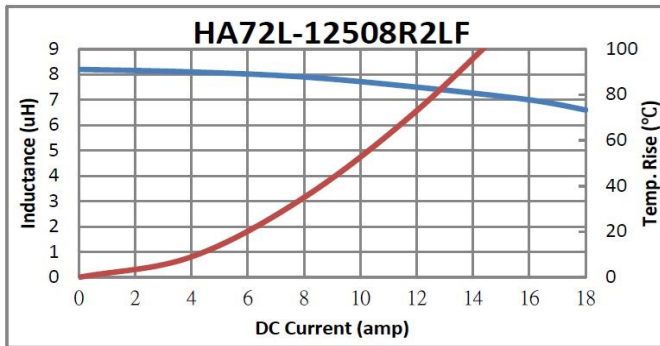
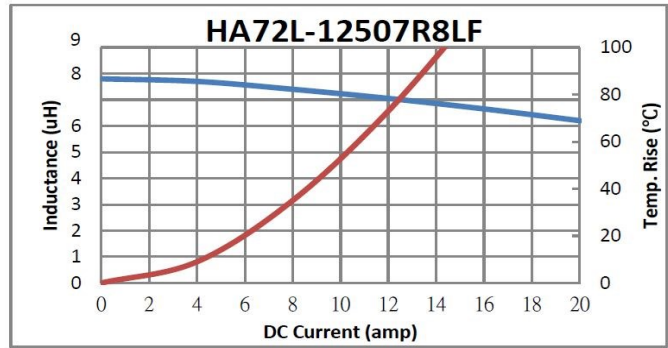
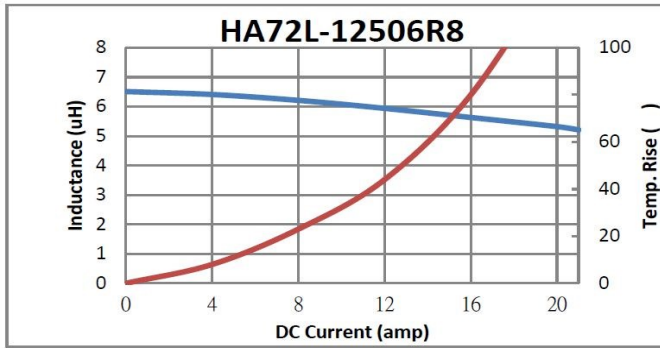

General Note  
 TT Electronics reserves the right to make changes in product specification without notice or liability. All information is subject to TT Electronics' own data and is considered accurate at time of going to print.

TT Electronics | BI Technologies  
 A-1445, Jalan Tanjung Api  
 25050 Kuantan Pahang Darul Makmur, Malaysia | Ph: +60 9 565 8888  
[www.ttelectronicsmagnetics.com/customer-service-enquiry](http://www.ttelectronicsmagnetics.com/customer-service-enquiry)

### Outline Dimensions (mm)

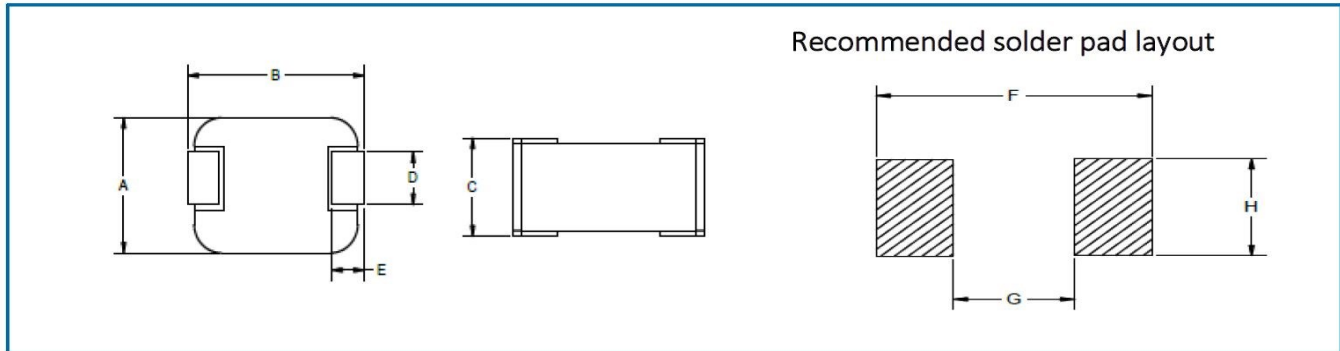

CASE SIZE	A(mm)	B(mm)	C(mm)	D(mm)	E(mm)	F(mm)	G(mm)	H(mm)
1250 series	12.8 ± 0.3	13.5 ± 0.5	5	3.5 ± 0.5	2.5 ± 0.5	15	6	5

### Packaging

Standard:	Embossed Tape and Reel		
	Reel:	Diameter	All case size = 13" (330mm)
		Capacity	Case size 1250 = 500 units

### Ordering Information

