



Hawk 3

**H335 and H345
3 1/2 Digit and 4 1/2 Digit
Advanced Digital Controller**

Operator's Manual



About this Manual

To the best of our knowledge and at the time written, the information contained in this document is technically correct and the procedures accurate and adequate to operate this instrument in compliance with its original advertised specifications.

Notes and Safety Information

This Operator's Manual contains warning headings that alert the user to check for hazardous conditions. These appear throughout this manual where applicable, and are defined below. To ensure the safety of operating performance of this instrument, these instructions must be adhered to.



Warning, refer to accompanying documents.

Attention, consulter les documents d'accompagnement.



Caution, risk of electric shock.

Attention, risque de choc électrique.

This instrument is designed to prevent accidental shock to the operator when properly used. However, no engineering design can render safe an instrument which is used carelessly. Therefore, this manual must be read carefully and completely before making any measurements. Failure to follow directions can result in a serious or fatal accident.

Technical Assistance

SIMPSON ELECTRIC COMPANY offers assistance Monday through Friday 8:00 am to 4:30 pm Central Time by contacting Technical Support or Customer Service at (715) 588-3311.

Internet: <http://www.simpsonelectric.com>

Warranty and Returns

SIMPSON ELECTRIC COMPANY warrants each instrument and other articles manufactured by it to be free from defects in material and workmanship under normal use and service, its obligation under this warranty being limited to making good at its factory or other article of equipment which shall within one (2) year after delivery of such instrument or other article of equipment to the original purchaser be returned intact to it, or to one of its authorized service centers, with transportation charges prepaid, and which its examination shall disclose to its satisfaction to have been thus defective; this warranty being expressly in lieu of all other warranties expressed or implied and of all other obligations or liabilities on its part, and SIMPSON ELECTRIC COMPANY neither assumes nor authorizes any other persons to assume for it any other liability in connection with the sales of its products.

This warranty shall not apply to any instrument or other article of equipment which shall have been repaired or altered outside the SIMPSON ELECTRIC COMPANY factory or authorized service centers, nor which has been subject to misuse, negligence or accident, incorrect wiring by others, or installation or use not in accord with instructions furnished by the manufacturer.

Contents

Quick Start Reference for Typical Control Instrument Features		5
	Installation and Wiring	5
	Programming	5
	Basic Key Operation for Programming	5
	Decimal Point	5
	Linearization	6
	Set Points & Relays	6
1. INTRODUCTION		8
1.1	General Description	8
1.2	Specifications	8
2. INSTALLATION AND PANEL CUTOUT		10
2.1	Mounting Requirements	10
2.2	Engineering Label Placement	10
2.3	Removing / Installing Modules	11
3. INPUT CARDS		11
3.1	Low Current	11
3.2	High Current	12
3.3	Volts	13
3.4	Resistance	14
3.5	Relay Cards	14
3.6	Power Supply Cards	15
4. OUTPUT CARDS		15
4.1	Excitation	16
5. DISPLAY AND KEYPAD CONTROLS		17
5.1	Operating the Keys	17
	5.1.1 Run Mode	17
	5.1.2 Program Mode	17
	5.1.3 Edit Mode	17
	5.1.4 Reset to Factory Defaults	17
	5.1.5 Password Reset	17

Contents (Con't)		
6. PROGRAMMING		18
6.1	Programming Order	18
6.2	General Programming Guidelines	18
6.3	Programming Menu	18
6.4	Setpoint and Relay Control	19
	6.4.1 Setpoint Values	19
	6.4.2 Relay Settings	19
6.5	Display Control	21
6.6	Measurement Control	22
6.7	Output Control	23
	6.7.1 Setting the Limits (LIM)	23
6.8	Scaling / Linearization Control	25
	6.8.1 Linearization Detail	26
6.9	Password	28
	6.9.1 Password Entry	29
	6.9.2 Changing the Password	29
7. RS-485 COMMUNICATIONS		29
7.1	RS-485 Command Structure	29
7.2	Prefix	29
7.3	Address	29
7.4	Valid Commands	30
7.5	Examples	32
8. FLOW CHART		34
9. ORDERING INFORMATION		37

QUICK START REFERENCE FOR TYPICAL CONTROL INSTRUMENT FEATURES

This section outlines the most commonly used features of the Hawk 3 controller and functions as a quick start guide. Please refer to the table of contents to find in-depth information or advanced features.

Installation and Wiring

See Section 1 in this manual for specific wiring and installation information pertaining to user's specific unit. With only the power supply wired, the Hawk 3 can be programmed before installation. The Hawk 3 features non-volatile memory; programming information will not be lost due to power loss or when changing meter's location.

Programming

Many of the advanced features of the Hawk 3 respond to, and interact with, each other. When programming the Hawk 3 it is important that the proper order is followed when setting up features. The following is the recommended order.



1. Decimal Point
2. Linearization (AKA Scaling)
3. Set Point/Relay Control (if applicable)
4. Analog output or other applicable controls.

Basic Key Operation (for Programming)

1. ◀ enters the main programming menu, backs out of submenus (one level at a time) and returns to run mode from the main menu. Exiting the programming menu in this manner assures that all changes will be saved. ◀ also moves the cursor to the left.
2. ▲▼ scrolls through menus and changes parameters.
3.  opens submenus, moves a blinking parameter into edit mode and allows editing.

Decimal Point

Using the 3-1/2 digital Hawk 3 as an example, the decimal point can be placed in any one of 5 locations without affecting the number. For example, 10 volts will display as 10.00. This display can be changed to get 100.0. Keep in mind that the decimal point is still needed for some applications.

1. Press ◀ to enter the programming mode.
2. Scroll ▲ until "d[] [] []" (display control) shows. Press .
3. When "dP" and "2345" flashes, press .
4. "2345" is now a fixed display. Use ▲ or ▼ to move the decimal point as necessary. Press .
5. Use ◀ to save changes.

Linearization

Using a Hawk 3 3-1/2 digits meter with a 200mVDC range, the following example shows 2 pt. linearization for 150DCA application using a 50mV shunt.

Please refer to Section 6.8.1 for multiple point linearizations and in-depth instruction.

1. Press **◀** to enter programming mode.
2. Scroll **▲** until "SCtL" (screen control) displays.
3. Press **RESET ENTER** "L i n" (linearization) should display.
4. Press **RESET ENTER** Display flashes "oFF" and "C o r d" (coordinate).
5. Press **RESET ENTER** oFF is now a fixed display. Scroll up until "2Pt" displays. Press **RESET ENTER**.
6. The display flashes a number and "ELE 1". Press **RESET ENTER**.
7. Use appropriate **◀**, **▲** or **▼** buttons to change the numbers as follows. If necessary, move cursor one place to the left of "2" to remove the "-" sign. (See page 5, Basic Key Operations)

$ELE 1 = 0.0$, $dSP = 0.0$, $ELE 2 = 50.0$ and $dSP 2 = 150.0$

8. Use **◀** to save changes. You may need to press the left arrow several times till "uPdE FLSH" shows on the meter.

Now 150.0 is on the display with 50.0DCmV applied to the input.

Set Points & Relays



CAUTION: Before editing the set points and relays check that the decimal point and linearization are set properly.

Avant de modifier les points de consigne et relais vérifier que le point décimal et linéarisation sont correctement définies.

1. Press **◀** to enter programming mode.
2. Scroll **▲** or **▼** until the appropriate menu item (SP 1 – SP 4) displays. Press **RESET ENTER**.
3. The display should flash between "VAL" (Value) and a number (default is 10.00). Press **RESET ENTER**.
4. Set number to the desired value by using **◀**, **▲** or **▼**. Press **RESET ENTER**.
5. Set relay response. The display will flash alternately from "dLAY" to "rSP". Press **RESET ENTER**. Use **▲** or **▼** to select choice: Delay, Latch or Hysterisis. Only one response can be set.

- a. Delay: This parameter will actuate the given relay after a set amount of time when past the set point setting. Press **RESET ENTER**.

The display will show "d_L o" and a number. Press **RESET ENTER**.

- i. Use **◀**, **▲** or **▼** to enter the amount of delay time (0-60 Sec).

- ii. Press **RESET ENTER**. The display will show "d_H i" and a number.

- iii. Press **RESET ENTER**. Enter the amount of delay time (0-60 Sec). Press **RESET ENTER**.

- b. Latch: This parameter will actuate the given relay. To reset manually, press **RESET** **ENTER** .
 - i. The display will flash between “**L E C H**” and a number. Press **RESET** **ENTER** .
 - ii. Enter the amount of delay desired before the relay actuates. (0-60 Seconds) Press **RESET** **ENTER** .
- c. Hysterisis: This is the percentage above or below the setpoint where the relay will actuate.
 - i. The display will show “**H _ L o**” and a number. Press **RESET** **ENTER** .
 - ii. Enter the % of hysterisis (0-29.9%) falling Edge, Press **RESET** **ENTER** .
 - iii. The display will show “**H _ H i**” and a number. Press **RESET** **ENTER** .
 - iv. Enter the % of hysterisis (0-29.9%) rising Edge. Press **RESET** **ENTER** .
6. To set alarm to “**Hi**”, “**Lo**” or “**Off**”, press **RESET** **ENTER** when display flashes Choose “**Hi**”, “**Lo**” or “**Off**” and press **RESET** **ENTER** .
7. Next choose the state of the relay to be Normally Energized “**n E**” or De-Ener-gized “**n d**”. When display flashes press **RESET** **ENTER** . Choose desired state Press **RESET** **ENTER** to return to main menu.
8. Set SP2, SP3 and SP4 as necessary and save changes.

1. INTRODUCTION

1.1 General Description

The Simpson Electric Hawk 3 Advanced Digital Panel Meter/Controller has both 3-1/2 and 4-1/2 digit displays. All LEDs are 7 segment and offer 5 brightness levels.

This high quality instrument has user-programmable parameters, all set from the front panel in easy to understand terminology. The display shows activated set point indicators (up to four). The keypad buttons have both audible and tactile feedback to prevent keystroke errors.

1.2 Specifications

DISPLAY	
Type	7- segment, red LED, 4 or 5 digits
Height	0.56" (14.2mm)
Brightness	5 settings, user programmable
Decimal Point	4 or 5 position, user programmable
Overrange Indication	Display flashes "EEEE" indicating Maximum Value Exceeded (Example: H335)
Underrange Indication	Display flashes "-EEE" indicating Minimum Value Exceeded (Example: H335)
Alarm Indicators	4 LED indicators for up to four independent setpoints
Linearization	H335 has a 2 points H345 has a 16 points
POWER REQUIREMENTS	
AC	85 to 250 VAC or 120VAC @ 10VA
DC	9 to 36 DCV @ 10VA
Isolation	250V RMS MAX
Note: Each supply is shown at the maximum and minimum values except the 120 VAC unit, which is allowed $\pm 10\%$	
ENVIRONMENTAL	
Operating Temperature	0 to 50°C
Storage Temperature	-10 to +60°C
Relative Humidity	< 80% for the temp. up to 31°C and decreasing linearly to 50% relative humidity at 50°C
Ambient Temp	25°C
Temperature Drift	± 100 ppm /°C
Warmup time	10 minutes
NOISE REJECTION	
NMRR	60 dB @ 50-60 Hz
CMRR	70 db @ 50-60 Hz
Note: For indoor use to an altitude up to 200m	
ANALOG TO DIGITAL CONVERSION	
Technique	Successive approximation with oversampling
Sample Rate	10 conversions per second
Display Rate	User Programmable from 1 - 420 updates / minute (240 default)

RS-485 Specications (only available on H345)

2 wire / Half duplex, Baud rate: 9600 baud, 1ms delay per character, 32 Nodes Maximum on Bus. Optically and magnetically isolated for ground loop elimination

MECHANICAL

Bezel	3.92" x 2.0" x 0.52" (99.8mm x 51.9mm x 132mm)
Depth	3.24" (82.3mm) behind panel
Panel cutout	3.62" x 1.77" (92mm x 45mm) 1/8 DIN
Weight	10 oz. (283.5 g)
Cover	NEMA 4X Rated front panel

ELECTRICAL

Accuracy	Listed as % of reading at 25°C. Add 100ppm/°C to compensate for drift. Tested at 50Hz, include +/-1 count for every 100Hz above 50 Hz
Transient Overvoltage	Installation Category III, Pollution Degree 2
Analog Output	Sampling Rate = 100 mSec. Reaction Time 0 to Full Scale = 10 µSec

Table 1 - 1

Input Board Type	Range	Resolution 4-1/2	Resolution 3-1/2	Input Impedance	Overload	Accuracy 4-1/2	Accuracy 3-1/2
DC Voltage	200 mV	10 µV	.1 mV	1M Ω	5 DCV	± .05% of reading ± 1 count	± .1% of reading ± 1 count
	2 V	.1 mV	1 mV	1M Ω	5 DCV	± .05% of reading ± 1 count	± .1% of reading ± 1 count
	20 V	1 mV	10 mV	1M Ω	300 DCV	± .05% of reading ± 1 count	± .1% of reading ± 1 count
	200 V	10 mV	.1 V	1M Ω	300 DCV	± .05% of reading ± 1 count	± .1% of reading ± 1 count
	600 V	.1 V	1 V	1M Ω	1K DCV	± .1% of reading ± 1 count	± .2% of reading ± 1 count

Table 1 - 2

Input Board Type	Range	Resolution 4-1/2	Resolution 3-1/2	Input Impedance	Overload	Accuracy 4-1/2	Accuracy 3-1/2
DC Current	200 µA	10 nA	.1 µA	1K Ω	4.5 mA DC	± .05% of reading ± 1 count	± .1% of reading ± 1 count
	2 mA	.1 µA	1 µA	100 Ω	45 mA DC	± .05% of reading ± 1 count	± .1% of reading ± 1 count
	20 mA	1 µA	10 µA	10 Ω	200 mA DC	± .05% of reading ± 1 count	± .1% of reading ± 1 count
	200 mA	10 µA	.1 mA	1 Ω	600 mA DC	± .05% of reading ± 1 count	± .1% of reading ± 1 count
	2 A	.1 mA	1 mA	.013 Ω	5.5 A DC	± .2% of reading ± 1 count	± .3% of reading ± 1 count
	5 A	1 mA	10 mA	.013 Ω	5.5 A DC	± .2% of reading ± 1 count	± .3% of reading ± 1 count

Table 1 - 3

Input Board Type	Range	Resolution 4-1/2	Resolution 3-1/2	Input Impedance	Overload	Accuracy 4-1/2	Accuracy 3-1/2
AC Voltage (Same for TRMS * @ 60 Hz)	200 mV	10 µV	.1 mV	200K Ω	5 DCV	± .05% of reading ± 1 count	± .1% of reading ± 1 count
	2 V	.1 mV	1 mV	200K Ω	5 DCV	± .05% of reading ± 1 count	± .1% of reading ± 1 count
	20 V	1 mV	10 mV	1M Ω	300 DCV	± .05% of reading ± 1 count	± .1% of reading ± 1 count
	200 V	10 mV	.1 V	1M Ω	300 DCV	± .05% of reading ± 1 count	± .1% of reading ± 1 count
	600 V	.1 V	1 V	1M Ω	1K DCV	± .1% of reading ± 1 count	± .2% of reading ± 1 count

Table 1 - 4

Input Board Type	Range	Resolution 4-1/2	Resolution 3-1/2	Input Impedance	Overload	Accuracy 4-1/2	Accuracy 3-1/2
AC Current (Same for TRMS * @ 60 Hz)	200 µA	10 nA	.1 µA	1K Ω	4.5 mA DC	± .1% of reading ± 1 count	± .2% of reading ± 2 count
	2 mA	.1 µA	1 µA	100 Ω	45 mA DC	± 1% of reading ± 2 count	± .2% of reading ± 2 count
	20 mA	1 µA	10 µA	10 Ω	200 mA DC	± .1% of reading ± 2 count	± .2% of reading ± 2 count
	200 mA	10 µA	.1 mA	1 Ω	600 mA DC	± .1% of reading ± 2 count	± .2% of reading ± 2 count
	2 A	.1 mA	1 mA	.013 Ω	5.5 A DC	± .2% of reading ± 2 count	± .3% of reading ± 2 count
	5 A	1 mA	10 mA	.013 Ω	5.5 A DC	± .2% of reading ± 2 count	± .3% of reading ± 2 count

Table 1 - 5							
Input Board Type	Range	Resolution 4-1/2	Resolution 3-1/2	Input Impedance	Overload	Accuracy 4-1/2	Accuracy 3-1/2
Resistance	200 Ω	10 m Ω	.1 Ω	1.2K Ω	± 5 DCV	$\pm .1\%$ of reading ± 2 count	$\pm .1\%$ of reading ± 2 count
	2K Ω	.1 Ω	1 Ω	12K Ω	± 5 DCV	$\pm .1\%$ of reading ± 2 count	$\pm .1\%$ of reading ± 2 count
	20K Ω	1 Ω	10 Ω	121K Ω	± 5 DCV	$\pm .1\%$ of reading ± 2 count	$\pm .1\%$ of reading ± 2 count
	200K Ω	10 Ω	100 Ω	1.2M Ω	± 5 DCV	$\pm .1\%$ of reading ± 2 count	$\pm .1\%$ of reading ± 2 count

Note: TRMS signals below 1% of full scale may become unstable because of TRMS process.

2. INSTALLATION AND PANEL CUTOUT

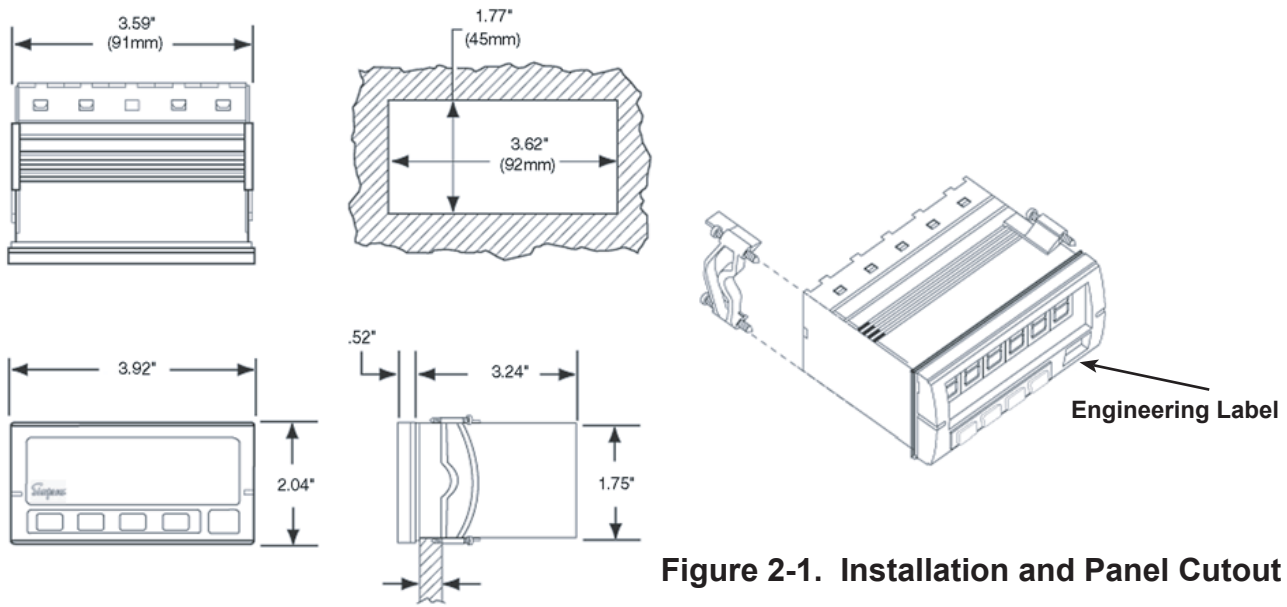

Figure 2-1. Installation and Panel Cutout

2.1 Mounting Requirements

Mounting Requirements

The Hawk 3 Advanced Digital Controller 1/8 DIN meters require a panel cutout of 1.77" (45mm) high by 3.62" (92mm) wide. To install the meter into a panel cutout, remove the clips from the side of the meter.

Slide the meter through the panel cutout, then slide the mounting clips back on the meter. Press evenly to ensure a proper fit. Tighten screws.

2.2 Engineering Label Placement

Engineering Label Placement

To replace the engineering unit label, place the tip of a ballpoint pen into the small hole at the base of the engineering label in the bezel.

Slide the label up until it pops out. Grasp and remove. Slide the new label half the distance in, then use the ballpoint pen to slide it down into place.

2.3 Removing / Installing Modules



Shut power off before removing or installing modules.

Couper le courant avant de retirer ou d'installer des modules.

1. Remove module from case by inserting a screwdriver into tab slot opening on top of the module. Apply pressure to release module from case. Repeat procedure for tab located on underside of the module and slide the module away from the case.
2. To install a module, carefully align the module edges with the slots in the case and press forward until the tabs (on top and bottom) engage.

NOTE: It is not recommended to replace input modules in the field; instrument would require calibration.

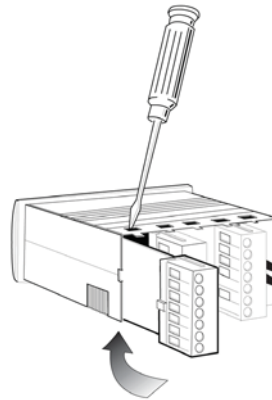

Figure 2.2. Removing Option Module

3. INPUT CARDS

3.1 Low Current

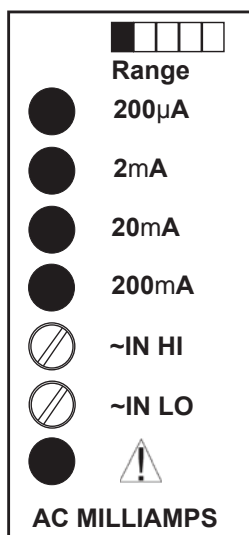

Figure 3.1

AC/TRMS Current:

The low current card can be configured from the factory to operate at 200 microamp (200 μ A) full scale up to 200 milliamp (200mA) full scale.

Because the signals measured may be less than the noise in the surrounding environment, a shielded cable should be used with the signal source end connected to earth ground.

Refer to section 1.2 for complete operating specifications on each range.



WARNING: With this and all input cards, do not exceed 250 Vrms between "IN LO" and earth ground.

ATTENTION: Avec cela et toutes les cartes d'entrée, ne pas dépasser 250 Veff entre "IN LO" et la terre.

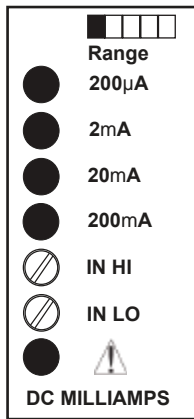



Figure 3.2

DC Current: The low current card can be configured from the factory to operate at 200 microamp (200µA) full scale or up to 200 milliamp (200mA) full scale. Because the signals measured may be less than the noise in the surrounding environment, it is recommended that a shielded cable be used with the signal source end connected to earth ground.

The polarity is important for the DC card to operate properly. Connect the most positive “+” signal to the “IN HI” terminal and most negative “-” to the “IN LO” terminal.



WARNING: With this and all input cards, do not exceed 250 Vrms between “IN LO” and earth ground.

ATTENTION: Avec cela et toutes les cartes d’entrée, ne pas dépasser 250 Veff entre “IN LO” et la terre.

3.2 High Current

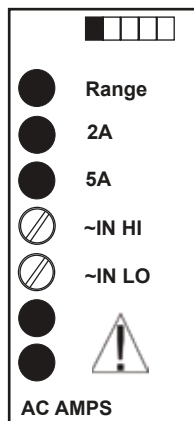



Figure 3.3

AC/TRMS Current: The high current card can be configured from the factory to operate at 2 amp (2A) full scale up or 5 amp (5A) full scale. Because long lengths and small wire can cause losses to the signal measured, it is recommended that wire lengths are kept less than 10 feet and wire be no less than 20 gauge.

Refer to section 1.2 for complete operating specifications on each range.



WARNING: With this and all input cards, do not exceed 250 Vrms between “IN LO” and earth ground. Use isolation transformers or donut current transformers to monitor high voltage equipment.

ATTENTION: Avec cela et toutes les cartes d’entrée, ne pas dépasser 250 Veff entre “IN LO” et la terre. Utilisez des transformateurs d’isolement ou beignet transformateurs de courant pour surveiller les équipements haute tension.

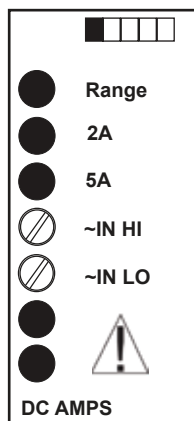



Figure 3.4

DC Current: The high current card can be configured from the factory to operate at 2 amp (2A) full scale up or 5 amp (5A) full scale. Because long lengths and small wire can cause losses to the signal measured, it is recommended that wire lengths are kept less than 10 feet and wire be no less than 20 gauge.

The polarity is important for the DC card to operate properly. Connect the most positive “+” signal to the “IN HI” terminal and most negative “-” to the “IN LO” terminal.



WARNING: With this and all input cards, do not exceed 250 Vrms between “IN LO” and earth ground. Use isolation transformers or donut current transformers to monitor high voltage equipment.

ATTENTION: Avec cela et toutes les cartes d’entrée, ne pas dépasser 250 Veff entre “IN LO” et la terre. Utilisez des transformateurs d’isolement ou beignet transformateurs de courant pour surveiller les équipements haute tension.

3.3 Volts

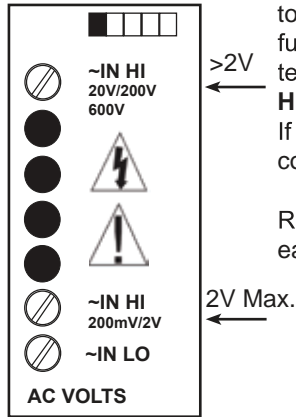

Figure 3.5

AC /TRMS Volts: The voltage card can be configured from the factory to operate at 200 millivolt (200 mV) full scale or up to 600 Volts (600V) full scale. Depending on how the card is configured, “IN HI” is one of two terminals. If the input is configured for 2 volts or 200 millivolts, use the “IN HI” connection closest to “IN LO”.

If the input is configured for 20 volts, 200 volts or 600 volts, use the “IN HI” connection farthest away from “IN LO” (Top of card).

Refer to section 1, paragraph 1.2 for complete operating specifications on each range.



WARNING: With this and all input cards, do not exceed 250 Vrms between “IN LO” and earth ground. Connect “IN LO” to neutral line or use isolation transformers to monitor high voltage equipment.

ATTENTION: Avec cela et toutes les cartes d’entrée, ne pas dépasser 250 Veff entre “IN LO” et la terre. Connectez “IN LO” à la ligne neutre ou utiliser des transformateurs d’isolement pour surveiller l’équipement de haute tension.

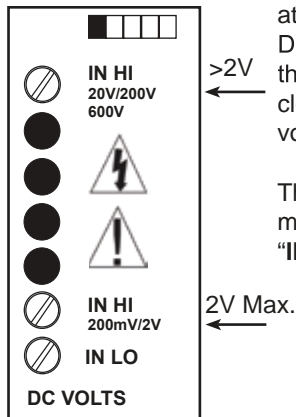

Figure 3.6

DC Volts: The voltage card can be configured from the factory to operate at 200 millivolt (200 mV) full scale or up to 600 Volts (600V) full scale.

Depending on how the card is configured, “IN HI” is one of two terminals. If the input is configured for 2 volts or 200 millivolts, use the “IN HI” connection closest to “IN LO”. If the input is configured for 20 volts, 200 volts or 600 volts, use the “IN HI” connection farthest away from “IN LO” (Top of card).

The polarity is important for the DC card to operate properly. Connect the most positive “+” signal to the “IN HI” terminal and most negative “-” to the “IN LO” terminal.



WARNING: With this and all input cards, do not exceed 250 Vrms between “IN LO” and earth ground. Connect “IN LO” to neutral line or use isolation transformers to monitor high voltage equipment.

ATTENTION: Avec cela et toutes les cartes d’entrée, ne pas dépasser 250 Veff entre “IN LO” et la terre. Connectez “IN LO” à la ligne neutre ou utiliser des transformateurs d’isolement pour surveiller l’équipement de haute tension.



Damage and serious injury will occur if connection instructions for input cards are not followed.
If the operating range of any input card needs changed, please contact a factory authorized service center.

Dommages et des blessures graves se produire si les instructions de connexion pour les cartes d’entrée ne sont pas respectées.
Si la plage de fonctionnement de tous les besoins de la carte d’entrée a changé, s’il vous plaît contacter un centre de service autorisé de l’usine.

3.4 Resistance

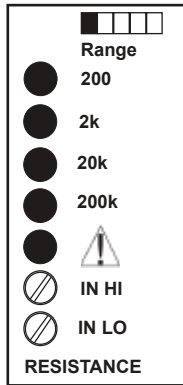



Figure 3.7

The resistance card can be configured to: 200 ohm, 2000 ohm (2K), 20,000 ohm (20K) and 200,000 ohm (200K) from the factory.

Use the 'Tare' feature to remove resistance offset created by lead length. Short the remote resistor end and 'Tare', this will re-zero the input and cancel lead length resistance. The card provides a DC signal to measure the resistance input accurately.



Do not apply any external voltage or current to this card; damage will occur.

Ne pas appliquer de tension ou de courant à cette carte externe; des dommages.

3.5 Relay Cards

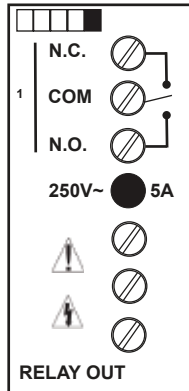

Figure 3.8
Single Relay

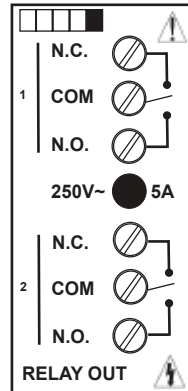

Figure 3.9
Dual Relay

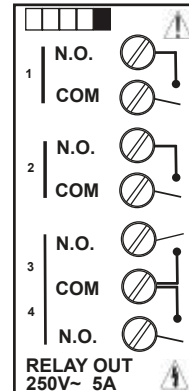



Figure 3.10
Quad Relay

The relay cards are directly related to any alarms that occur on the Hawk 3. The single relay is a "Form C" (SPDT) relay that activates in relationship to "SP1".

The dual relay consists of two Form C" (SPDT) relays that activate in relationship to "SP1" & "SP2".

The quad relay consists of four "Form A" (SPST) relays that activate in relationship to "SP1" through "SP4".



WARNING/CAUTION: "SP3" and "SP4" connections share a common.

All relay contacts are rated at 250 VAC @ 5 amp maximum. The rating of the relay contact is intended for resistive circuits only. Use a snubber circuit to protect the contacts from inductive loads.

AVERTISSEMENT / ATTENTION: "SP3" et connexions "SP4" partagent une commune.

Tous les contacts de relais sont évalués à 250 VAC @ 5 ampères maximum. La note du contact de relais est destiné uniquement aux circuits résistifs. Utiliser un circuit de protection pour protéger les contacts à partir de charges inductives.

3.6 Power Supply Cards

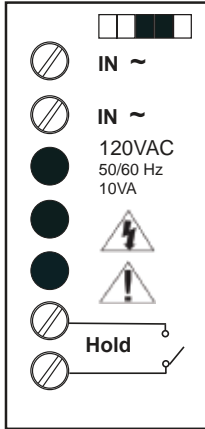

Figure 3.11
120 VAC Supply

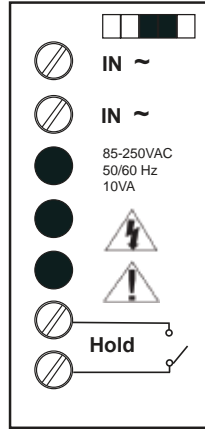

Figure 3.12
Universal AC Supply

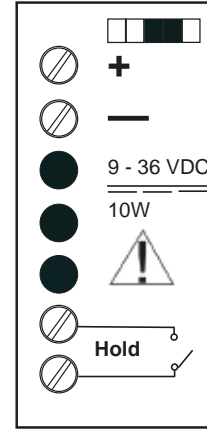



Figure 3.13
DC to DC Supply

The AC power cards operate from standard 50/60 Hz line power. The polarity for connecting AC power (IN-) is unimportant. The unit operates either way. The DC to DC power card is an isolated supply that operates between 9 and 36 volts DC.

The “Hold” feature is used to freeze the display. When the contacts are shorted, the display will “Hold” the last reading until short is removed. It is recommended that a mechanical switch or relay be used to activate the hold circuit; solid state relays may give unexpected results. The hold circuit cannot be externally powered.

An external fuse is required for safe operation. For AC supply, use a Slow Blow fuse at .25A, Littlefuse Part No. 313.250 or equal. For DC supply use a Slow Blow fuse at 1.25A, Littlefuse Part No. 3131.25 or equal. *Fuse only one input.*



CAUTION: Hazardous voltages may be present. Disconnect power before making or removing connections.

Des tensions dangereuses peuvent être présentes. Coupez l'alimentation électrique avant d'effectuer ou de retirer les connexions.

4. OUTPUT CARDS

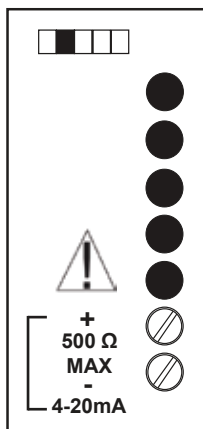

The 4-20mA output card will generate an isolated output between 4mA and 20mA that is related to the input level. This relationship can be set using the menu. Linearization will also affect the relation. The factory default is when the input is at its lowest level, the output is 4mA. When the input is at the maximum rated input, the output is at 20mA.

Figure 4.1
4-20mA

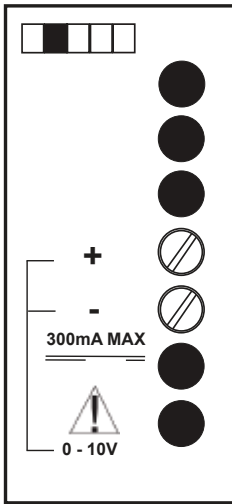

The 0-10VDC output card will generate an isolated output between 0VDC and 10VDC that is related to the input level. This relationship can be set using the menu.

Linearization will also affect the relation. The factory default is when the input is at its lowest level the output is 0VDC. When the input is at the maximum rated input the output is at 10VDC.

Figure 4.2 0 - 10VDC

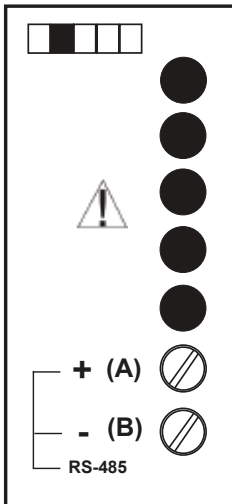

The RS-485 card is used for communication in a network where multiple sensors (not necessarily those of Hawk 3) report back to a central host computer.

The RS-485 card is configured for 9600 baud, 8 bit, 1 stop bit, no parity, half duplex serial communication, and will respond on a polled basis only. Each Hawk 3 will respond to its own unique address only after being requested by the host. The Hawk 3 remains a listener until asked to respond. (See section 7 of this manual for further details about using the RS-485 card.)

Figure 4.3 RS-485

4.1 Excitation

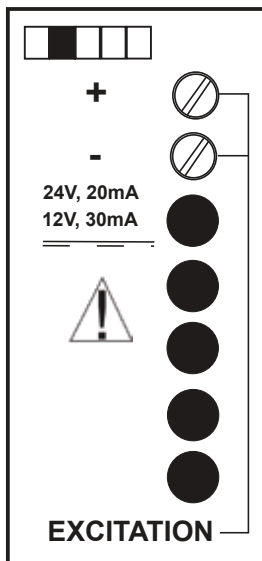

Figure 4.4

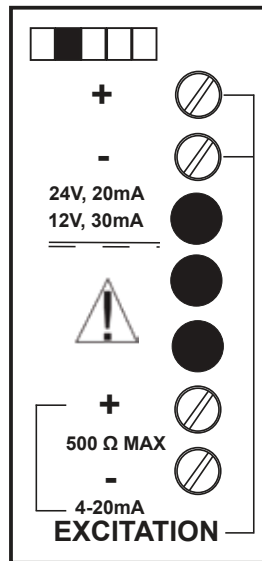

Figure 4.5

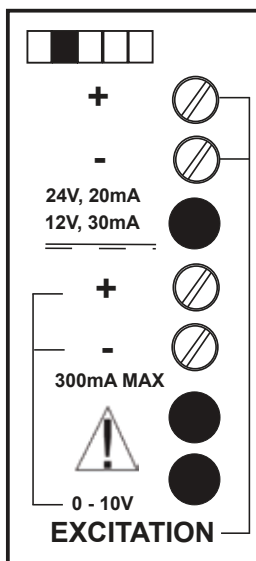

Figure 4.6

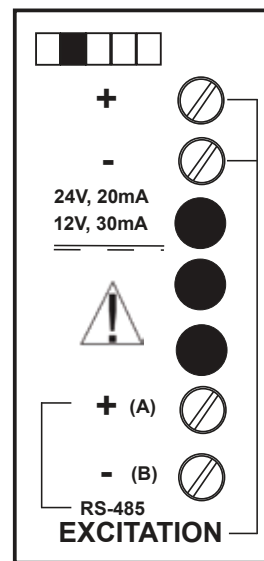
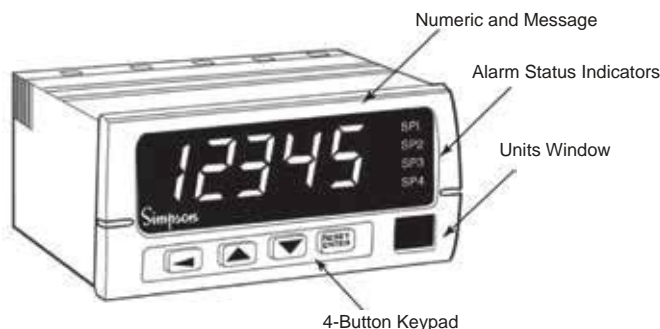

Figure 4.7

The Excitation output card provides a factory set isolated DC voltage of either 12VDC or 24VDC. The maximum output current for the 12VDC is 30mA and 20mA for the 24VDC. Excitation is available alone or can be included with the other outputs.

5. DISPLAY AND KEYPAD CONTROLS



5.1 Operating the Keys

5.1.1 Run Mode

◀ = Enters the Program Menu

▲ = Displays the Maximum Value (if enabled). Press ▲ and hold while pressing **RESET ENTER** to clear maximum value.

▼ = Displays Minimum Value (if enabled). Press ▼ and hold while pressing **RESET ENTER** to clear minimum value.

RESET ENTER = Resets Latched Relays (If any).

▲ and ▼ = Sets Zero/Tare Value (if enabled). Also clears Minimum and Maximum values.

5.1.2 Program Mode

◀ = Enters the Edit Mode. Flashing cursor shows value to edit (Numeric Values only).

▲ = Scrolls "UP" through menu.

▼ = Scrolls "DOWN" through menu.

RESET ENTER = Selects a menu or submenu to edit.

5.1.3 Edit Mode

◀ = Moves Edit Cursor to the left. Flashing cursor shows value to edit (Numeric Values Only).

▲ = Increases Numeric Value or Scrolls "UP" through submenu.

▼ = Decreases Numeric Value or Scrolls "DOWN" through submenu.

RESET ENTER = Confirms and Saves the new setting.

5.1.4 Reset to Factory Defaults

Simultaneously press ◀ and ▲ when power is first applied to the unit.

5.1.5 Password Reset

Simultaneously press ▼ and **RESET ENTER** when power is first applied to the unit.

6. PROGRAMMING

6.1 Programming Order

The following parameter order is recommended to change the display from the default values. Parameters entered in any other order may cause unexpected results.

dP - Always change the decimal point location first, to the desired display range. The decimal point will then be in the proper position for setting setpoints or linearization. Magnifying the display from 10 to 100 is as simple as moving the decimal point.

L IN - Linearization affects the setpoints and analog-out results. If decimal point location is changed, it will display in the wrong place for electrical input, but in the desired location for output display.

SP 1 - 4 - The setpoints follow the displayed results of any linearization or decimal point settings and not necessarily the electrical input.

ANALOG OUT - The analog-out “Hi and Lo” settings also track the display results from the above changes and not the electrical input.

6.2 General Programming Guidelines

Changes can be made while programming, unless the outputs or relay alarms are critical to operation.

1. Press ◀ to move in and out of the main programming.
2. Press ▲ or ▼ to scroll to desired submenu. Press **RESET ENTER** to enter a submenu. Press ◀ to scroll back to main menu.
3. To change a flashing parameter press **RESET ENTER** and press ▲, ▼ or ◀. To save the change and proceed to the next change, press **RESET ENTER**.

NOTE: ALWAYS SAVE CHANGES! Improperly saved changes will be lost if power fails.

4. Press **RESET ENTER** after making the last change, then return to run mode by pressing ◀ while in main menu mode. “UPdt FL5H” will display before displaying run mode.

6.3 Programming Menu

Available menu choices depend on the operator’s password rights. Use caution when changing values “on the fly” because relay changes are immediate upon exiting menus. While in local menu, RS-485 communications will halt to avoid command conflict. When in local or remote menu, relay and alarm operations are suspended. If left in menu mode the local or remote menu will “time out” in two minutes then resume normal operation.

6.4 Setpoint and Relay Control

The following relates to setting the setpoints 1 thru 4 (if available).

Table 6-1

SP [1-4]	URL - [1-4]	Value	
	rSP (Response)	HYSL Hi	0* to 29.9 percent
		HYSL Lo	
		dLAY Hi dLAY Lo	
		LtCH	0* to 60.00 seconds
	ALr (Alarm)	Hi_*	
		Lo_	
		oFF	

* Factory Reset Default Values

6.4.1 Setpoint Values

The Hawk 3 can be purchased with up to 4 separate relay control setpoints (SP1 – SP4). Each setpoint needs to be individually programmed and can be set to a value that corresponds to a programmed display range. To set control setpoints press ◀ to enter programming mode.

1. Scroll ▲ or ▼ until the appropriate menu item “SP 1 – SP4” displays. Press **RESET ENTER**.
2. The display should flash between “URL” (Value) and a number. Press **RESET ENTER**.
3. Set this number to the desired value by using ◀, ▲ or ▼. Press **RESET ENTER**.

NOTE: While in programming menu, all other operations are suspended.

6.4.2 Relay Settings

Once the relay control setpoints are programmed, the display will flash alternately from “dLAY” to “rSP”. Press **RESET ENTER** to stop display flashing. Relay responses can now be set. Use ▲ or ▼ to select choice: Delay, Hysteresis or Latch.

NOTE: Only one response type can be set.

1. **Delay:** This is the amount of time the process has to be out of spec before the relay actuates.
 - a. The display will show “d.Lo” and a number. Press **RESET ENTER**.
 - b. Enter the amount of delay Lo (Falling edge) time (0-60 Sec) value by using ◀, ▲ or ▼. Press **RESET ENTER**.
 - c. The display will show “d.Hi” and a number. Press **RESET ENTER**.
 - d. Enter the amount of delay Hi (Rising edge) time (0-60 Sec) by using ◀, ▲ or ▼. Press **RESET ENTER**.

2. **Hysteresis:** This is the percentage above or below the setpoint where the relay actuates.
 - a. The display shows “H_Lo” and a number. Press **RESET ENTER**.
 - b. Enter the % of hysteresis (0-29.9%) falling Edge by using ◀, ▲ or ▼. Press **RESET ENTER**.
 - c. The display shows “H_Hi” and a number. Press **RESET ENTER**.
 - d. Enter the % of hysteresis (0-29.9%) rising Edge by using ◀, ▲ or ▼. Press **RESET ENTER**.

3. **Latch:** This parameter sets the given relay in activation even after the alarm condition has been removed. To reset the relay press **RESET ENTER**.
 - a. The display will flash between “LEH” and a number. Press **RESET ENTER**.
 - b. Enter the amount of delay desired before the relay actuates (0-60 Seconds) by using ◀, ▲ or ▼. Press **RESET ENTER**.

4. **Alarm:** The unit now flashes alternately between “ALr” and “Hi”. The alarm condition can now be set to either above the setpoint (**Hi**), below the setpoint “Lo” or “oFF”. To set alarm to “Hi”, “Lo” or “oFF”, press **RESET ENTER** when display flashes. Choose “Hi”, “Lo” or “oFF” by using ▲ or ▼. Press **RESET ENTER**.

5. **State:** Choose the desired relay state, Normally Energized “nE” or De-Energized “nd” when the unit is not in alarm. The unit will flash alternately between “St” and “nd”. Press **RESET ENTER**. Choose either “nE” or “nd” by using ▲ or ▼. Press **RESET ENTER**.

6. Press ◀ to return to main menu.

7. Set SP2, SP3 and SP4 as necessary and save changes.

*Table 6-2
Relation between State, Alarm and Type of Relay Card Chart*

Relay Card/State and Alarm Settings	Single	Double	Quad
De-Energized no alarm	NC-Com connected	NC-Com connected	NO-Com disconnected
De-Energized in alarm	NO-Com connected	NO-Com connected	NO-Com connected
Energized no alarm	NO-Com connected	NO-Com connected	NO-Com connected
Energized in alarm	NC-Com connected	NC-Com connected	NO-Com disconnected

This chart shows the relationship between the Alarm and State settings and the type of relay card used.

NC = Normally closed terminal
 NO = Normally opened terminal
 Com = Common terminal

6.5 Display Control

Table 6-3

d[LL		
	dP (Decimal Point)	▲ and ▼ arrows move dP through 5 (4 for 3½) positions and “no dP”
	Fr5H (Refresh)	Value - 1 to 480 updates per minute (240*)
	band	Value - 0* to 99 counts from current value.
	briht (Brightness)	▲ and ▼ arrows move LED brightness through 5 levels as indicated on display. (5* full brightness)

* Factory Reset Default Values

dP (decimal point position): the decimal point location can serve as the magnification of a value. For Example: To display 0-200 or 2000 on a 0-20 volt meter move the decimal point to represent that scale. The display comes without decimal point enabled, Electrical Full Scale will be 20,000 counts on the display (With the exception of 5 Amps).

The decimal point should be set before setting linearization.

1. Press ◀ to enter the programming mode.
2. Scroll ▼ until “d[LL” (display control) shows. Press **RESET ENTER**.
3. When “dP” and “12345” flashes, press **RESET ENTER**.
4. “12345” is now a fixed display. Use ▲ or ▼ to move the decimal point as necessary. Press **RESET ENTER**.
5. Exit the programming menu by pressing ◀ until “uPdt FL5H” flashes. Exit the programming menu properly to make sure system changes will be saved. If “uPdt FL5H” does not display, changes must be re-entered and saved.

Display refresh; “Fr5H”, will show the numbers of updates made. This setting ranges from 480 updates per minute (8 updates per second) to 1 update per minute.

1. When “Fr5H” and “240” flashes, press **RESET ENTER**.
2. “00240” is now displayed. Use ◀, ▲ or ▼ to change the refresh rate. Press **RESET ENTER**.

The display banding, “band” works differently. The value entered is the amount of digit movement allowed before the display is updated. With a band setting of 2, the value must move 2 counts up or down in the rightmost position to update the display.

1. When “band” and “0” flashes, press **RESET ENTER**.
2. “00000” is now displayed. Use ◀, ▲ or ▼ to change the band. Press **RESET ENTER**.

NOTE: “Fr5H” and “band” can adjust the display response and remove “pops” and “jitters”. The actual raw signal is evaluated against the setpoint and will go into alarm even if the display was set for maximum filtering and gave no indication of nearing the setpoint. Use hysteresis or delay in SP menu to slow relay action.

brightness (Brightness) has 5 settings. The default is set to the brightest setting (5).

1. When “br 1t” and “5” flashes, press **RESET ENTER**. Number “5” is now displayed.
2. Use ▲ or ▼ to adjust the brightness. Press **RESET ENTER**.

6.6 Measurement Control

Table 6-4

NEAR5		
	LR E (Zero)	Off* On Hold
	Hi Lo (Minimum/Maximum)	Off* On

* Factory Reset Default Values

LR E (Zero or Null): using tare allows user to grab a running offset and zero to it. A running offset can monitor the tolerance of a value instead of the value itself, or remove some signal offset in a measurement. Once tare is enabled in the menu (Tare = ON), the device will wait until ▲ and ▼ is pressed. The unit will then grab the current value and offset the display to zero. Choose “hold” in the tare menu to save the tare value to a more permanent location. No new tare can be taken, but the value will be saved if power fails.

NOTE: Be aware that introducing a tare value will change the setpoint thresholds and erase any previous Hi Lo readings.

1. Press ◀ to enter the programming mode.
2. Scroll ▼ until “NEAR5” (Measure control) shows. Press **RESET ENTER**.
3. When “LR E” and “on” flashes, press **RESET ENTER**.
4. “on” is now a fixed display. Use ▲ or ▼ to move between “on”, “OFF” and “Hold”. Choose the setting you want then press **RESET ENTER**.

“Hi Lo” (Min/Max), tracks the history of the displayed readings. This menu allows you to either enable or disable this feature.

1. When “Hi Lo” and “on” flashes, press **RESET ENTER**.
2. “on” is now displayed. Use ◀ or ▶ to change the setting. Press **RESET ENTER**.

6.7 Output Control

Two optional outputs are available, digital output or analog output.

Table 6-5

oCtL		
dRER 5Er (RS-485)	Adr (Address)	01* to 99 (hex)
	Node	Full*
		Inq
ALoG (Analog Output)		
	LIM	HI (Electrical Limit 100*)
		Lo (Electrical Limit 0*)
	FS (Fail Safe) (Overrange or Underrange)	HI (move to 20mA)
		LO (move to 4mA)
		Off*

* Factory Reset Default Values

The digital output is an RS-485 2 wire communication port. It has a fixed baud rate of 9600 baud, half duplex and is addressable. When this card is installed, the Hawk 3 senses the card and opens the menu choices available to the card. For detailed command sets and communication configuration, please refer to RS-485 Communications, section 7 of this manual.

The analog output is a current or voltage that represents an equivalent range of signal on the input. Analog output can be purchased as 4-20mADC out or 0-10V DC out. When installed, the Hawk 3 senses the card and opens the menu choices available to the card.

6.7.1 Setting the Limits (LIM)

The ends of the analog output range (4 & 20 or 0 & 10) can be set or 'pegged' anywhere within the displayed value of the meter.

Example 1: The Hawk 3 is purchased as a standard 200 volt meter. The analog output is configured by default, HI=100.0 and LO=0. When the display reaches 100 volts, the analog output will be 20mA. When the display reaches 0 volts the analog output will be 4mA. In order to change the analog output to 20mA at 200 volts change the "HI" to 200.0

Example 2: The Hawk 3 is purchased as a process meter 4-20 mA input which displays 0-100 percent. The analog output is configured, by default, for HI=100.0 and LO=0. When the display reaches 100 percent the analog output will be 20 mA. (Because the meter is a process meter, the input should be 20mA.) When the display reaches 0 percent the analog output will be 4mA.

The limits can be moved or reversed (HI=0 and LO= 80.0). In this case when the display reads "0", the analog output will be 20mA and when the display reads "80", the analog output will be 4mA.

The Fail Safe option “F5” controls the action of the analog output when the display goes into overrange (EEEE or -EEEE). In some cases, the low limit or high limit is reserved for error conditions. Set to “Hi”, the output will run to the 20mA value when overrange or underrange occurs. With failsafe set to “Lo”, the output will run to 4mA at overrange or underrange. With failsafe “oFF” the output will go to the defined limit ends. (Typically -EEEE would be 4mA and EEEE would be 20mA.)

1. Press ◀ to enter the programming mode.
2. Scroll ▼ until “oCtL” (output control) shows. Press **RESET ENTER**.
3. What the unit displays depends on the type of output card installed.
 - a. If no output card is installed then “no” and “CRd” will flash and no further action can be taken. Press **RESET ENTER** to continue.
 - b. If a digital RS-485 card is installed “dRA” and “SEr” will flash. Press **RESET ENTER**. “Addr” and a number will flash. Press **RESET ENTER**. The present address displays. Press ◀, ▲ or ▼ to change the address. Press **RESET ENTER**. “ModE” and “FULL” or “i nQ” will flash. Press **RESET ENTER**. The present mode displays. Use ▲ or ▼ to change mode. Press **RESET ENTER**.
 - c. If an analog card is installed “ALoC” and “out” flashes. Press **RESET ENTER**. “L i nE” will display. Press **RESET ENTER**. “Hi” will display. Use ◀, ▲ or ▼ to change the value. Press **RESET ENTER**. “Lo” will display. Use ◀, ▲ or ▼ to change the value. Press **RESET ENTER**. “F5” and “Hi”, “Lo” or “oFF” will display. Press **RESET ENTER**. The present failsafe mode will display. Use ▲ or ▼ to change the failsafe mode. Press **RESET ENTER**.

6.8 Scaling / Linearization Control

Improved linearization on the Hawk 3 allows use of all digits; -9999 to 9999 with the 3.5 digit version and -99999 to 99999 with the 4.5 digit version. The 4.5 version can also be linearized up to 16 points in order to accommodate non-linear processes. The 3.5 version only has 2 point linearization.

NOTE: Linearization must be done with a positive slope. Linearization cannot be done with a negative slope or parabola.

Table 6-6

5[1]						
	Lin (Linearization)					
	Coord (Coordinates)	oFF				
		1 Pt	ELE1	= value	DSP1	= value
		2 Pt	ELE2	= value	DSP2	= value
		3 Pt	ELE3	= value	DSP3	= value
		4 Pt	ELE4	= value	DSP4	= value
		5 Pt	ELE5	= value	DSP5	= value
		6 Pt	ELE6	= value	DSP6	= value
		7 Pt	ELE7	= value	DSP7	= value
		8 Pt	ELE8	= value	DSP8	= value
		9 Pt	ELE9	= value	DSP9	= value
		10 Pt	ELE10	= value	DSP10	= value
		11 Pt	ELE11	= value	DSP11	= value
		12 Pt	ELE12	= value	DSP12	= value
		13 Pt	ELE13	= value	DSP13	= value
		14 Pt	ELE14	= value	DSP14	= value
		15 Pt	ELE15	= value	DSP15	= value
		16 Pt	ELE16	= value	DSP16	= value

See 7.8.1 for more detail on linearization.

1. Press ◀ to enter the programming mode.
2. Scroll ▲ or ▼ until "5[~~1~~]" (Scale / Linearization control) displays. Press **RESET ENTER**.
When "Coord" and a number and "Pt" flashes, press **RESET ENTER**.
5. A number and "Pt" is now a fixed display. Use ▲ or ▼ to increase or decrease the number of coordinate points as necessary. Press **RESET ENTER**.
6. The display will flash "ELE", a point number and the setting. Press **RESET ENTER**.
7. Enter the electrical value using ◀, ▲ or ▼. Press **RESET ENTER**.
8. The display will flash "dSP", a point number and the setting. Press **RESET ENTER**.
9. Enter the display value using ◀, ▲ or ▼. Press **RESET ENTER**.
10. Continue these steps until all coordinates have been entered.
11. Exit the programming menu by pressing ◀ until "UPdt FL5H" flashes. If "UPdt FL5H" does not display, system changes must be re-entered and saved.

6.8.1 Linearization Detail

Linearization off. In this mode the display will relate directly to the electrical input.

A 20VDC unit will show -20000 to 20000 on the 5 digit display.
Graphically, the input has a 1 to 1 correspondence to the display.

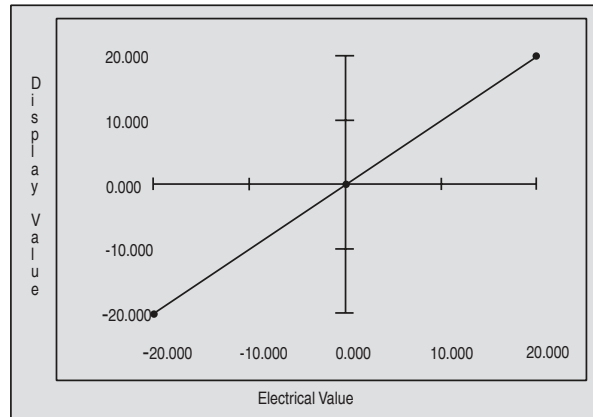

Figure 6-1

1 point Linearization:

In this mode the display relates indirectly to the electrical input.

Example 1, The 20VDC relates to a 0 to 35kv transformer.
A 20VDC unit will show 0 to 35000 on the 5 digit display.

Input tells the device that 20.000 electrical will correspond to 35000 on the display.

Notice that on 1 point linearization symmetry is assumed about zero, and in this case, there is no zero offset. The display will show (EEE or -EEE) when the display exceeds 35000 or goes below -5000.

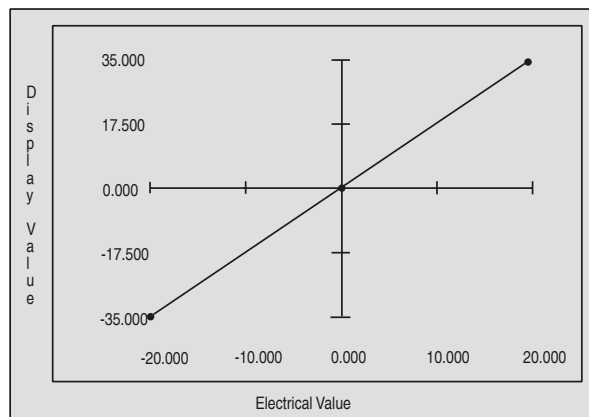

Figure 6-2

Example 2, The 20VDC has a 5 volt offset at zero. A 20VDC unit will show -15000 to 25000 on the 5 digit display.

We would tell the device that 0.000 electrical will correspond to 5.000 on the display.
Notice that on 1 point linearization symmetry is now assumed about the offset.
The display will show over-range (EEE or -EEE) when the display exceeds 25000

(25.000) or goes below -15000 (-15.000).

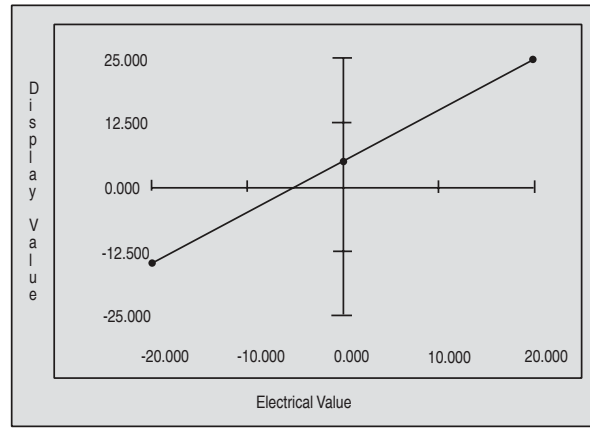

Figure 6-3

2 point Linearization: In this mode the display will relate indirectly to the electrical input. This case is typically used to create a process meter.

Using the example of a 20V DC meter, a 1 to 10VDC process output will be monitored and will display the result in percent. 1 Volt represents 0% and 10 Volt represents 100%. Notice that on 2 point linearization no symmetry is assumed. The display will show over-range (EEE or -EEE) when the display exceeds 10000, (100.00), (input above 10V even though the card is designed to handle up to 20V) or goes below 0(0.00).

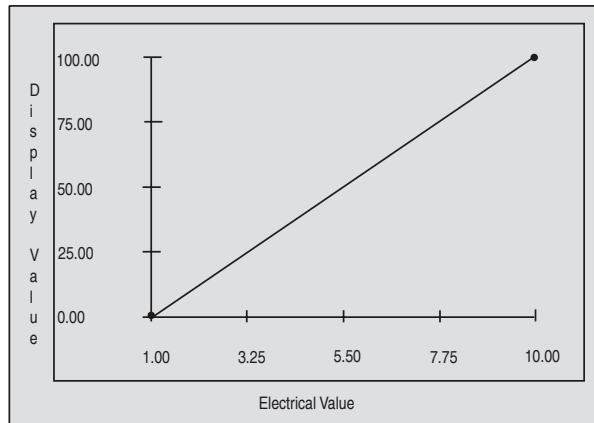

Figure 6-4

Multi-point Linearization: In this mode the display will not relate to the electrical input. This case is typically used to flatten a logarithmic response. This feature is only included on the 4-1/2 digit unit. Up to 16 points of data can be entered.

Using the example of a 20V DC meter, we wish to monitor a -5 to 20V DC pressure transducer that spans 0 psi to 300 psi but in a non linear way.

The transducer manufacturer provides the following information:

-5 Volts = 0 Psi

0 Volts = 10Psi

5 Volts = 40Psi

15 Volts = 80Psi

18 Volts = 200Psi

20 Volts = 300Psi

We will use this data to develop **6 point linearization**.

Notice that on Multi-point linearization no symmetry is assumed. The display will

show over-range (EEE or –EEE) when the display exceeds 30000 (300.00) or goes below 0 (0.00).

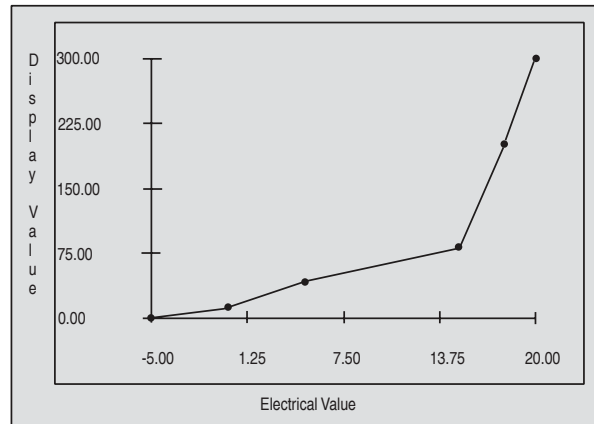

Figure 6-5

6.9 Password

Table 6.7

Pass (Password)		
Default	000	Full Access.
	001-200	No Access to System Control Menu (SCtL)
	201-400	No Access to SCtL and Measurement Control Menu (MEAS)
	401-600	No Access to SCtL, MEAS and Output Control Menu (oCtL)
	601-800	No Access to SCtL, MEAS, oCtL and Set-point Control Menus (SP1-SP4)
	801 to 999	No access except password entry
	-999	Keypad lockout. All future key strokes will be ignored. All setting changes must come from RS-485 port. This choice is available only if the RS-485 card is present and configured for "Full".
CHG		
	NUM-PR5 (New Password)	Change the password to a new value. This is available only after successfully entering the current password or if the password is set to 000.

The default password stops the user from accidentally entering into calibration mode. The Hawk 3 has several password levels.

6.9.1 Password Entry

1. Press ◀ to enter the programming mode.
2. Scroll ▲ or ▼ until "P55". Press **RESET ENTER**.
3. "P55 Enter" flashes followed by "123". Press **RESET ENTER**.
4. "00 123" and "3" flashes.
5. Use ◀, ▲ and ▼ to change display to "00000". Press **RESET ENTER**.
6. "0000" displays followed by "CHG".
7. Press ◀ to return to the main menu in order to continue programming.

6.9.2 Changing the Password

1. Follow previous steps 1 through 5, then press **RESET ENTER**.
2. "P55 Enter" flashes on the screen followed by "123". Press **RESET ENTER**.
3. Press ◀, ▲ and ▼ to change to any number between 0-999. Press **RESET ENTER**. "CHGd P55" will display followed by "CHG."
4. Press ◀ twice to return to main menu. Save changes.

7. RS-485 COMMUNICATIONS

The RS-485 card is used for communication in a network where multiple sensors (not necessarily Hawk 3 sensors) report back to a central host computer.

The RS-485 card is configured for 9600 baud, 8 bit, 1 stop bit, no parity, half duplex serial communication, and will respond on a polled basis only. Each Hawk 3 will respond to its own unique address only after being requested by the host. The Hawk 3 remains a listener until asked to respond.

7.1 RS-485 Command Structure

[Prefix][Address][Command][Checksum][Carriage Return]

7.2 Prefix

The Hawk 3 listens for messages beginning with one of two prefix characters, the dollar sign (\$, ASCII 36, 24h) or the pound sign (# , ASCII 35, 23h).

The dollar sign (\$) requests a short response from the Hawk and the pound sign (#) requests a long response with checksum from the Hawk.

7.3 Address

The next two characters represent the unit's address. The characters can range from "01" to "99". All other characters in this position are ignored. This will match the corresponding address on the Hawk 3 unit.

For example: With the address on the Hawk set at "01" the command to address it would be "\$01".

The same scheme is used to derive the checksum on a long response, the carriage return is again not calculated into the checksum.

7.4 Valid Commands

The first 10 commands do not suspend the Hawk operation and are valid commands for either “Full” or “Inq” modes.

RD	Read the display and any tripped alarms.
RST	Reset any latched relays.
RA1	Read alarm setpoint 1 information
RA2	Read alarm setpoint 2 information
RA3	Read alarm setpoint 3 information
RA4	Read alarm setpoint 4 information
RL	Read linearization values.
MAX	Read the maximum value reached. (MM1 must have been previously sent or HI LO was locally set to “on”)
MIN	Read the minimum value reached. (MM1 must have been previously sent or HI LO was locally set to “on”)
AO	Read analog output setting information.
TAR	Capture current display and use as tare or Zero offset. (T1 must have been previously sent or tare was locally set to “on”)

The following 40 commands are only available if Hawk 3 is set to “Full” mode.

Where the term “VALUE” is used it will represent a 5 digit number with a properly located decimal point.



WARNING: These commands suspend the operation of Hawk 3 until the “EXIT” command is issued. Hawk 3 will then resume monitoring its input and operating relays. (After 2 minutes, the unit will time out, flush all changes and resume normal operation.)

ATTENTION: Ces commandes suspendre l’opération de Hawk 3 jusqu’à ce que la commande “EXIT” est émis. Faucon 3 reprendra ensuite le suivi de ses relais d’entrée et de fonctionnement. (Après 2 minutes, l’appareil expirer, rincer tous les changements et reprendre le fonctionnement normal.)

DP	(0-5) Set decimal point location. 0= off, 1= before lsb... 5= before msb
MM1	Turn MIN MAX on.
MM0	Turn MIN MAX off.
T1	Turn tare on.
T0	Turn tare off.
SP1 (VALUE)	Setpoint value
SP2 (VALUE)	
SP3 (VALUE)	
SP4 (VALUE)	
AL1 (H,L,O)	Alarm threshold: High, Low, Off
AL2 (H,L,O)	
AL3 (H,L,O)	
AL4 (H,L,O)	
R1 (HH,HL,DH,DL,L) (NUM)	Relay response: HH hysteresis high, HL hysteresis Low
R2 (HH,HL,DH,DL,L) (NUM)	DH Delay high, DL Delay Low, L Latch
R3 (HH,HL,DH,DL,L) (NUM)	The NUM ber takes the format NN.NN with values limited to those shown in section 6.4.
R4 (HH,HL,DH,DL,L) (NUM)	Relay response

S1 (D,E)	State of relay when not in alarm: De-energized, Energized.
S2 (D,E)	
S3 (D,E)	
S4 (D,E)	
AOH (NUM)	Set the Analog Output Hi Limit
AOL (NUM)	Set the Analog Output Lo Limit
FS (0, 1, 2)	Analog Output Fail Safe Mode 0 = Off 1 = Lo Level 2 = Hi Level
PAS (NUM)	Change Password to the following NUMBER . (000 through 999 and -999)

Note: Linearization points must be loaded in ascending order, or unit will function erratically.

LP0	Linearization Off (Display values as measured electrically).
LP(1 – 16)	The number of linearization points to be loaded.
L1 (eVALUE),(dVALUE)	One point Linearization. Refer to the table on Linearization (6.5.6 and 6.5.7)
L2(eVALUE),(dVALUE)	Two point Linearization.
L3 (eVALUE),(dVALUE)	
L4 (eVALUE),(dVALUE)	
L5 (eVALUE),(dVALUE)	
L6 (eVALUE),(dVALUE)	
L7 (eVALUE),(dVALUE)	
L8 (eVALUE),(dVALUE)	
L9 (eVALUE),(dVALUE)	
L10 (eVALUE),(dVALUE)	
L11 (eVALUE),(dVALUE)	
L12 (eVALUE),(dVALUE)	
L13 (eVALUE),(dVALUE)	
L14 (eVALUE),(dVALUE)	
L15 (eVALUE),(dVALUE)	
L16 (eVALUE),(dVALUE)	Sixteen point Linearization.
EXIT	Implement previously sent commands. The Hawk 3 will then resume monitoring its input and operating relays.

Note: **EXIT** does not permanently save the changes.

SAVE Save present settings in flash memory.

Note: This step allows the unit to remember changes after a power down and to allow the Hawk 3 to resume normal operations. This step is not required for com-

mands that work in “Query” mode.

Response Structure:

The Hawk 3 will not echo the command sent to it, but, will reply in one of three ways:

1. “%” and some error message. The command was not understood or the optional checksum failed.
2. “*” The command was accepted and the response requires no data.
3. “*{DATA}” The command was accepted and DATA is supplied in return.

The percent mark (% , ASCII 37, 25h) and the asterisk (* , ASCII 42, 2Ah) are the only two valid response prefix characters.

Response Delay:

Hawk 3 should respond in less than 50mS. During this waiting period, no other commands should be issued. If Hawk 3 does not respond, assume no response and timeout.

7.5 Examples

NOTE: All replies will terminate with a carriage return (^M , ASCII 13, 0Dh). The following are some examples of commands and their expected response:

\$02RD *2=138.00A1A3	Read unit with address 02 Hawk 3 response: Value is 138.00 and alarm 1 and alarm 3 are tripped.
#02RD75	Read unit with address 02, long response, the checksum is 75.
*2=138.00A1A3C7	Unit address 02 response, value is 138.00, alarm 1 and alarm 3 are tripped with C7 as the checksum.
\$02SP1+12.000 *2	Configure setpoint 1 to 12.000. Hawk 3 response.
\$02AL1H *2	Configure setpoint 1 alarm high. Hawk 3 response.
\$02R1DH+2.00 *2	Configure setpoint 1 response to Hi delay of 2.0 seconds. Hawk 3 response.
\$02R1DL+0.50 *2	Configure setpoint 1 response to Lo delay of 0.5 seconds. Hawk 3 response.
\$02S1D *2	Configure setpoint 1 relay to be normally de-energized. Hawk 3 response.
\$02MM1 *2	Turn Min Max capability on. Hawk response.
\$02EXIT *2=UPDATE_RAM	Terminate menu settings and resume normal operation. Hawk 3 response.

\$02SAVE Permanently save the settings to flash memory.
***2=SAVE_TO_**
FLASH Hawk 3 response.

To verify last setting change:

\$02RA1 Read alarm 1 settings.
***2=HI 12.00,SP_**
DELAY=H2000ms,
L500ms,RELAY=ND Hawk 3 response: High setpoint at 12.000 with a Hi delayed
response of 2.0 seconds, a Lo delay of 0.5 seconds and
a normally de-energized relay.

\$02LP3 Set the number linearization points to 3.
***2** Hawk 3 Response

\$02L1E040.00D000.00 Linearization point 1 electrical input is 4000
counts, display shows 0.
***2** Hawk 3 response.

\$02L2E120.00D050.10 Linearization point 2 electrical input is 12000
counts, display shows 50.10
***2** Hawk 3 response.

\$02L3E200.00D100.00 Linearization point 3 electrical input is 20000
counts, display shows 100.00
***2** Hawk 3 response.

\$02EXIT Terminate menu settings, save changes and
resume normal operation.
***2=UPDATE_RAM** Hawk 3 response.

NOTE: After linearization changes, the Hawk 3 permanently saves the changes
to flash memory.

To verify last setting change:

\$02RL
***2=(1)E= 40.00,(1)D= 0,(2)**
E= 120.00,(2)D= 50.10,
(3)E= 200.00,(3)D= 100.00 Hawk 3 response

8. FLOW CHART

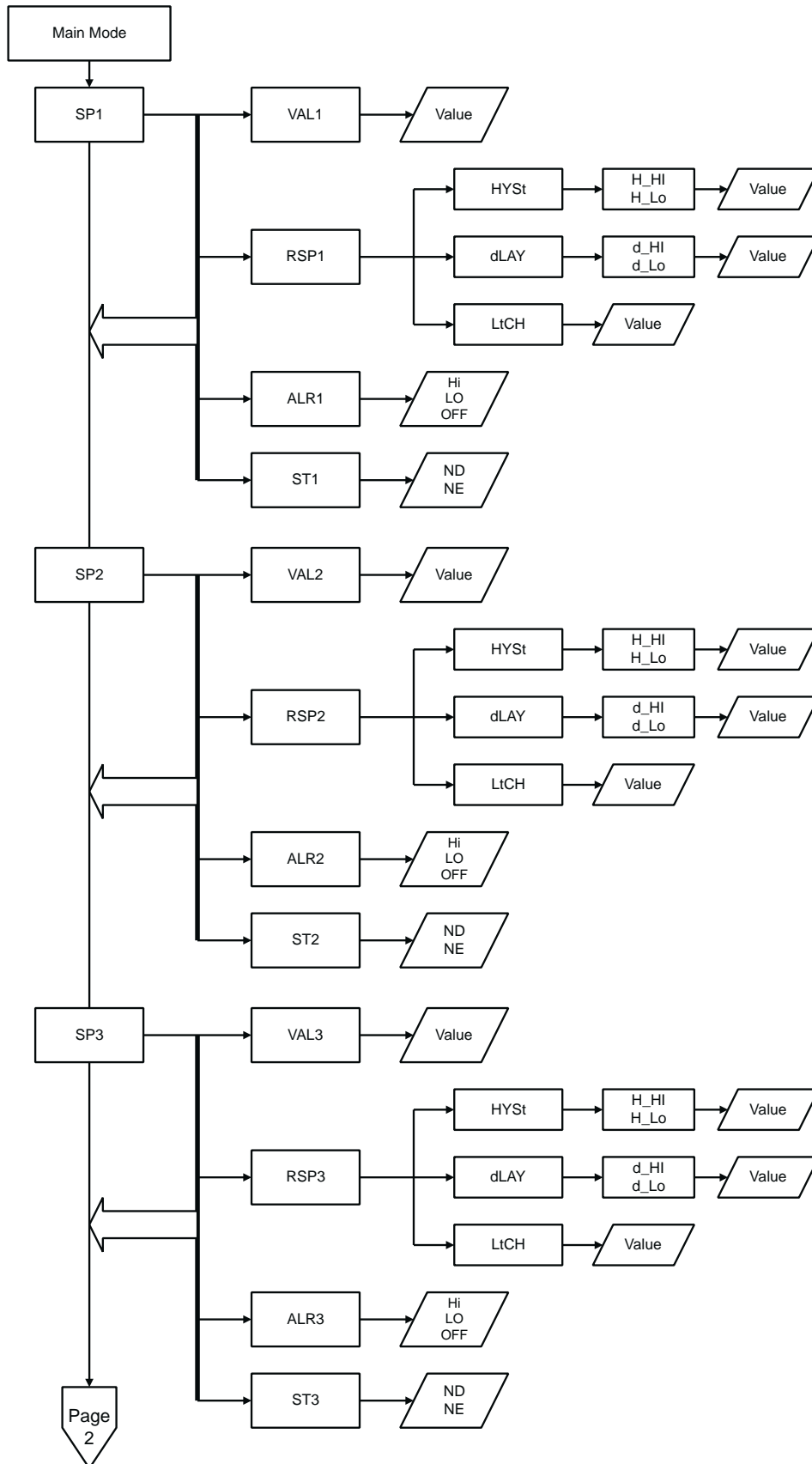

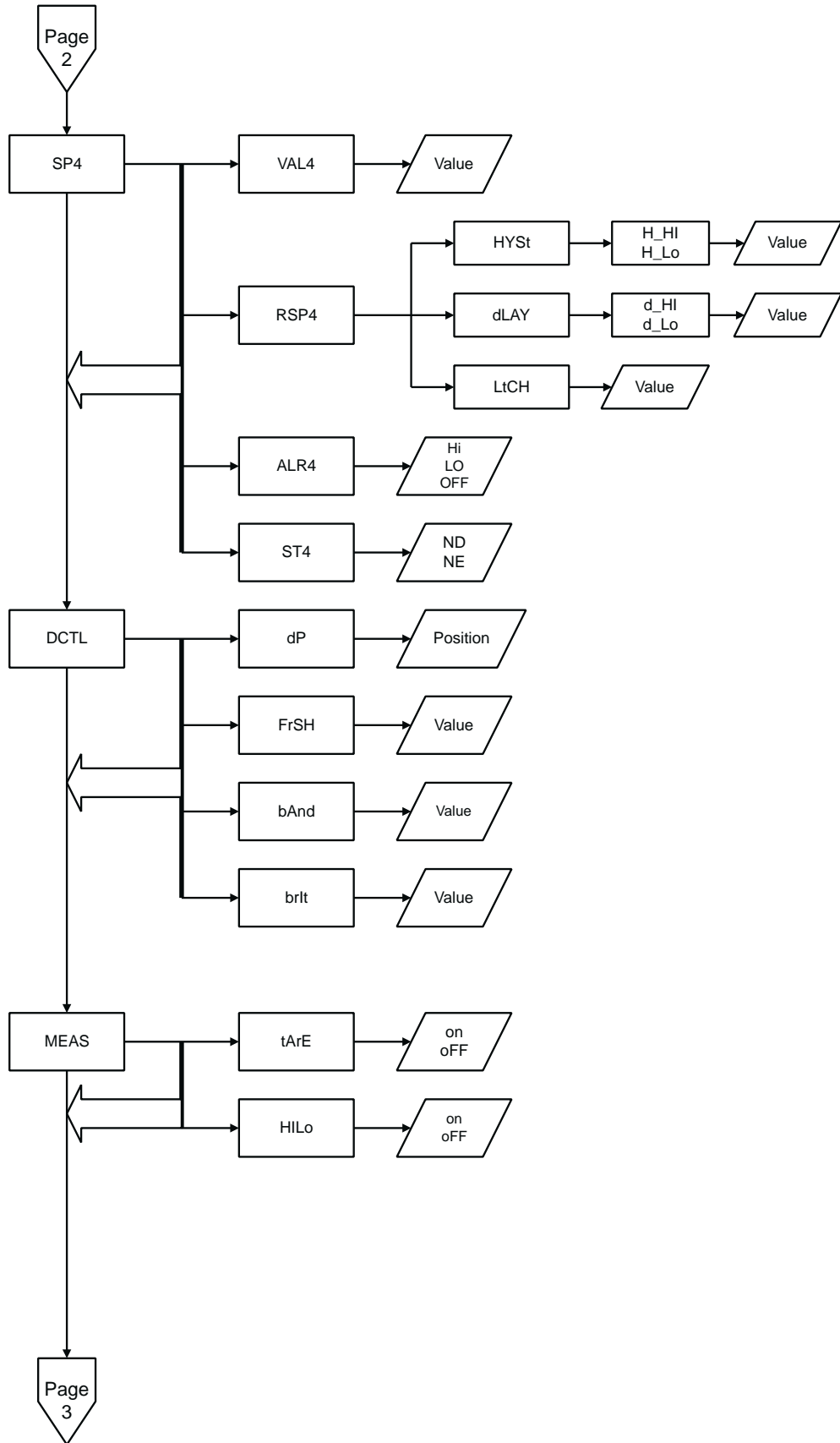

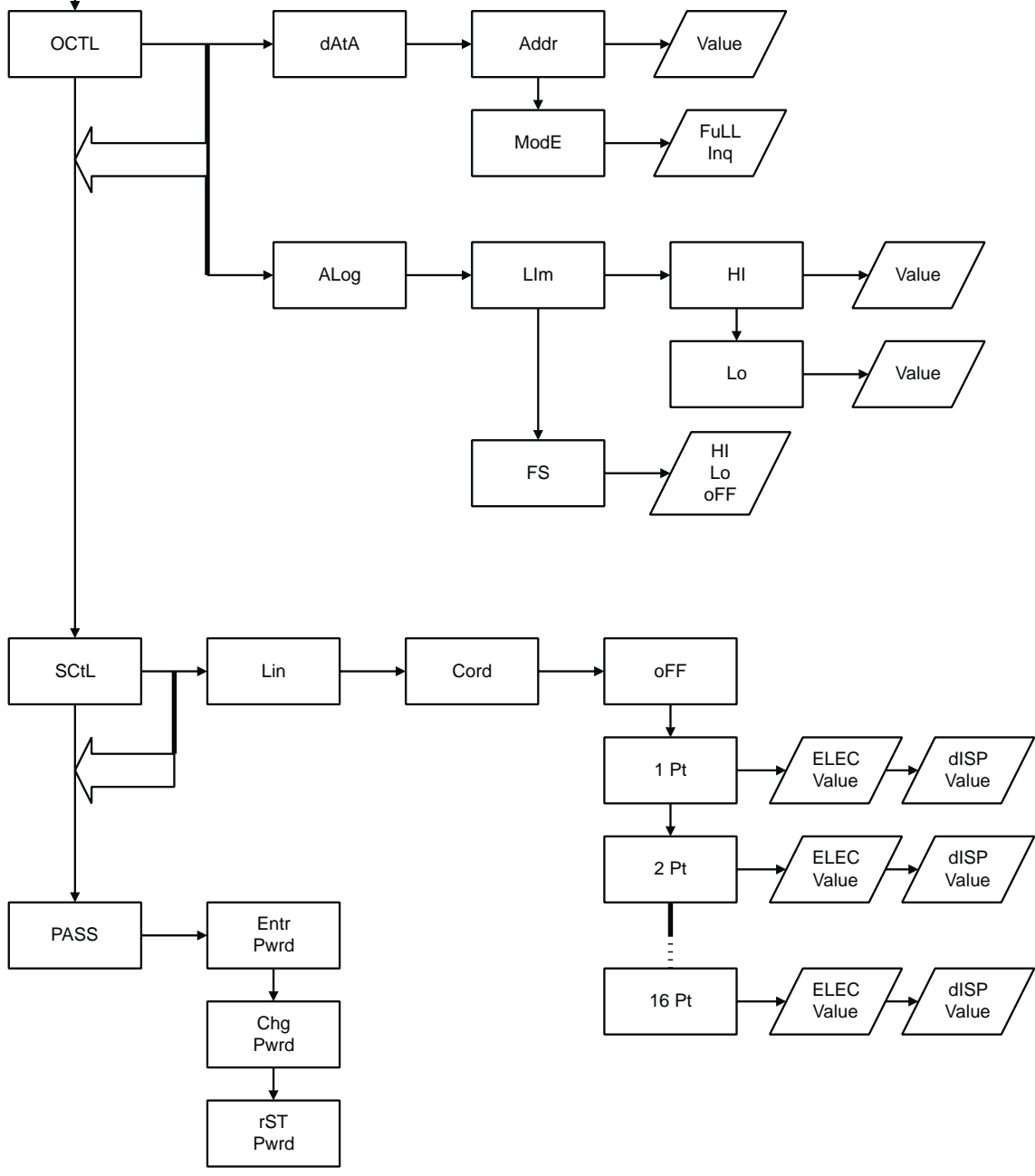

Ordering Information -

Hawk 3 Indicators can be configured by making an entry into each section. Example: H335-3-71-0-4-1

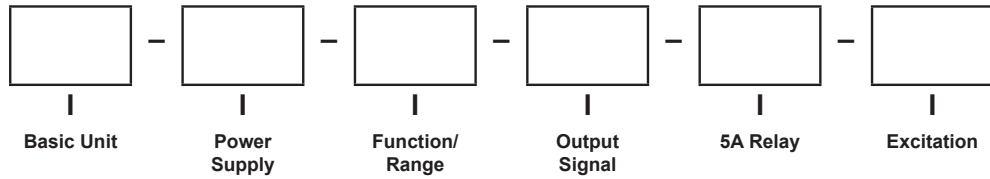

Select From Each One Below		
Basic Unit		
	H335	3-1/2 digit, Red LED
	H345	4-1/2 digit, Red LED
Power Supply		
	1	120 ACV (3-1/2 only)
	2	85-250 ACV (4-1/2 only)
	3	9-36 DCV
	4	85-250 ACV (3-1/2 only)
Function/Range		
	11	200 DCmv
	12	2 DCV
	13	20 DCV
	14	200 DCV
	15	600 DCV *
	21	200 DC μ A
	22	2 DCmA
	23	20 DCmA
	24	200 DCmA
	25	2 DCA
	26	5 DCA
	31	200 ACmV
	32	2 ACV
	33	20 ACV
	34	200 ACV
	35	600 ACV *
Function/Range		
	41	200 AC μ A
	42	2 ACmA
	43	20 ACmA
	44	200 ACmA
	45	2 ACA
	46	5 ACA
	51	200 ACmV TRMS
	52	2 ACV TRMS
	53	20 ACV TRMS
	54	200 ACV TRMS
	55	600 ACV* TRMS
	61	200 AC μ A TRMS
	62	2 ACmA TRMS
	63	20 ACmA TRMS
	64	200 ACmA TRMS
	65	2 ACA TRMS
	66	5 ACA TRMS
	71	4-20 DCmA Process
	72	0-10 DCV Process
	81	200 Ohm
	82	2K Ohm
	83	20K Ohm
	84	200K Ohm
Output Signal		
	0	None
	1	4-20 DCmA
	2	0-10 DCV
	6	RS-485 (4-1/2 only)
5A Relays		
	0	None
	1	One
	2	Two
	4	Four
Excitation		
	0	None
	1	12 DCV
	2	24 DCV
* Awaiting UL approval		

NOTES:

NOTES:

Simpson Electric Company
520 Simpson Avenue, Lac du Flambeau, WI 54538
(715) 588-3311 FAX (715) 588-3326
www.simpsonelectric.com

Part No. 06-117287, Edition 14, 01/19