



# Hot-Molded Panel Potentiometers



## Features

- Immersion Sealed
- Linear and Non-Linear Tapers
- Style RV6
- Rotary Switch Available

## Benefits

- Washable
- Versatility
- Meets MIL-R-94 Requirements
- Versatility

## AVAILABILITY

### Groupings

The Type G Hot-Molded Panel Potentiometers are divided into three groups.

**Distributor stocked potentiometers** — Potentiometers (listed in the table on Page 26) are stocked by Allen-Bradley appointed Electronic Distributors.

**OEM standard components** — (Bushing/Resistance/Taper Combinations and Bushing/Shaft/Taper Combinations listed in the table on

Page 26) are stocked as components at our manufacturing facilities. They offer a wider range of possible combinations than the distributor stocked potentiometers but do require assembly.

**All custom components** — All other components listed are available. Since they are not stocked, they require fabrication. Contact factory for information.

Available in standard values from stock at electronic distributors.

## SPECIFICATIONS

### General

Temperature range —  $-55^{\circ}\text{C}$  to  $+120^{\circ}\text{C}$ .

Total resistance values — 100 ohms to 5.0 megohms.

Total resistance tolerances —  $\pm 10\%$  or  $\pm 20\%$ .

Tapers — Available in the following resistance ranges:

TAPER	TOTAL RESISTANCE RANGE
U	100 Ohms to 5.0 Megohms
A, B, S & DB	500 Ohms to 2.5 Megohms

See chart on Page 24 for explanation of tapers. Special tapers, where practical, can be supplied.

End resistance — See chart on Page 24.

### Electrical

Power — 0.5 watt maximum at  $+70^{\circ}\text{C}$  for "U" linear taper provided voltage rating is not exceeded.

Power derating — Derate power linearly from  $+70^{\circ}\text{C}$  to zero at  $+120^{\circ}\text{C}$ . Derate power 50 percent for non-metallic mounting and for resistors with "A," "B," "S," and "DB" tapers. For rheostat applications derate power directly with shaft or actuator position.

Voltage — 350 volts maximum working voltage (RMS or DC), or as determined by  $E_{\text{max}} = \sqrt{PR}$ , whichever is less (at sea level).

Dielectric withstanding voltage — Maximum continuous voltage 350 volts (RMS or DC) at sea level. Will withstand a one second test of 750 volts (RMS) at sea level or 350 volts (RMS) at 3.4 inches (86,36 mm) mercury.

### Operational

Load life — 10 percent maximum change in total resistance as a result of a 1000 hour test at rated power across entire element in still air at  $+70^{\circ}\text{C}$  (1.5 hours "ON", 0.5 hour "OFF").

### Mechanical

Shafts — Diameter of shafts .125 inch (3,18 mm). Minimum length .062 inch (1,59 mm) longer than bushing. Maximum length 2.500 inches (63,50 mm) with plain, screwdriver slotted or flatted shaft endings.

Lengths are available in 1/64 inch (0,40mm) increments. All shaft lengths are measured from the mounting face of the resistor to the free end of the shaft.

Bushings — All bushings have a 32-NEF-2A thread and are .250 inch (6,35 mm) in diameter.

After lock nuts on locking bushings are tightened with a torque of 8 inch-pounds (9,22 kgf-cm) shafts will not turn with torques up to 20 inch-ounces (1,44 kgf-cm).

Hardware — Resistors are normally supplied with mounting nut, M-4721, and one internal tooth lock

Switches — Two types of single pole, single throw switches are available. One turns "ON" at start of clockwise shaft rotation, the other at the start of counterclockwise shaft rotation. The switch reduces effective electrical rotation to  $248^{\circ}$  nominal.

Switch rating for resistive loads are 0.5 ampere 125 volt 60 Hertz and 1.5 amperes 28 volt DC.

Switches can be operated 5000 mechanical cycles at full rating.

Applicable military specification — Many of the variable resistors without switches may be ordered as Style RV6 of MIL-R-94.

Insulation resistance — 1000 megohms minimum for clean and dry conditions at  $+25^{\circ}\text{C}$ .

Voltage characteristic — 0.005 percent per volt or 0.5 ohm, whichever is greater.

Capacitance — The capacitance between terminal #1 and #3 with terminal #2 "floating" is approximately 0.5 to 0.75 pF at 1 KHz.

The capacitance between terminal #1 (grounded to bushing) and terminal #3 (shaft in extreme clockwise position) approximately 3.0 to 3.7 pF at 1 KHz.

The capacitance between all terminals shorted together and the bushing is approximately 5.5 to 6.5 pF at 1 KHz.

In all cases capacitance indicated is for potentiometer only and does not include capacitance of connecting wires.

Rotational life — 10 percent maximum change in total resistance as a result of a 50,000 mechanical cycle life test without load.

washer, M-4748. Resistors with shaft lock bushings are supplied with one lock nut, M-4761, in addition to the above. Unless otherwise specified, all hardware shipped in bulk.

Mounting bracket B-28868 and printed wiring board F-19942 can also be supplied (separately or mounted on unit) to adapt bushing type resistors for horizontal mounting on printed wiring board. See dimensions on Page 29.

Locating lug options — Four locating lug options are available so resistors may be indexed with respect to the surface on which they are mounted. See dimensions. Unless otherwise specified, resistors are supplied with option No. 2.



## Mechanical (continued)

**Turning torque** — 0.5 to 3 inch-ounces (0,036 to 0,22 kgf-cm) at  $-25^{\circ}\text{C}$  and 13 inch-ounces (0,94 kgf-cm) maximum at  $-55^{\circ}\text{C}$ .

Maximum additional torque required to actuate the switch is 5 inch-ounces (0,36 kgf-cm).

**Stop torque** — 4 inch-pounds (4,61 kgf-cm) minimum.

**Rotation** — Mechanical rotation for resistors with or without switch is  $295^{\circ} \pm 5^{\circ}$ .

Electrical rotation is  $270^{\circ}$  nominal without switch and  $248^{\circ}$  nominal with switch.

**Backlash** —  $3^{\circ}$  maximum.

**Construction** — Materials are corrosion resistant and essentially non-magnetic; terminals are treated for easy soldering.

The resistor incorporates an internal "O" ring between the shaft and bushing. External surfaces are given special treatment so that the entire resistor is immersion sealed.

A panel "watertight" bushing is available. This bushing is provided with an external "O" ring in addition to the internal "O" ring supplied as standard.

**Immersion** — No continuous stream of bubbles (4 or more) emanating from the resistor as a result of the immersion test (1 minute in water at  $+85^{\circ}\text{C}$ ).

**Weight** — The exact weight of individual resistors depends on the precise mechanical specifications involved. Table below lists approximate net weights of typical Type GA resistors including hardware normally specified.

Bushing	Shaft	Weight	
		Ounces	Grams
.250 in. (6,35 mm) Plain	.750 in. (19,05 mm)	0.24	6.8
.375 in. (9,52 mm) Lock	.438 in. (11,11 mm)	0.24	6.8

**Marking** — Allen-Bradley part number and nominal total resistance are marked in two lines. Other marking possible, limited to maximum of 16 characters in each of two lines for resistors without switch and 9 characters in each of two lines for resistors with switch. A-B monogram plus "Type G" always included.

## Environmental

**Vibration** — 2 percent maximum change in total resistance, 5 percent maximum change in resistance setting. (Tested per method 204, condition "C" of MIL-STD-202.)

**Shock** — 2 percent maximum change in total resistance, 5 percent maximum change in resistance setting. (Tested per method 213, condition "I" of MIL-STD-202.)

**Moisture resistance** — 10 percent maximum change in total resistance. (Method 106 of MIL-STD-202.)

**Corrosion resistance** — Materials show no corrosion after a 200 hour salt spray test. (Method 101 of MIL-STD-202.)

**Effect of soldering** — 2 percent maximum change in total resistance as a result of immersing the terminals in  $+350^{\circ}\text{C}$  solder to within 0.62 inch (1,57 mm) of the resistor body for 5 seconds.

**Washability** — Capable of withstanding typical after-solder boardwash processes using approved detergent or solvent solutions.

**Temperature cycling** — 3 percent maximum change in total resistance as a result of the temperature cycling test (five cycles  $-55^{\circ}\text{C}$  to  $+120^{\circ}\text{C}$ ).

**Low temperature operation** — 2 percent maximum change in total resistance as a result of the low temperature operation test ( $-55^{\circ}\text{C}$  for two hours without load and 45 minutes with rated load.).

**Low temperature storage** — 2 percent maximum change in total resistance as a result of the storage test (24 hours at  $-63^{\circ}\text{C}$ ).

**Temperature characteristics** — Maximum percent temporary total resistance change from the  $+25^{\circ}\text{C}$  value. See table below.

Nominal Resistance	Degrees Celsius — "U" Linear Taper						
	$-55^{\circ}$	$-25^{\circ}$	$0^{\circ}$	$+25^{\circ}$	$+55^{\circ}$	$+85^{\circ}$	$+120^{\circ}$
100 Ohms	+ 4.5	+ 2.5	+ 1.5	0	$\pm 1.0$	$\pm 1.5$	+ 3.5
1,000 Ohms	+ 5.5	+ 3.0	+ 1.5	0	$\pm 1.0$	$\pm 2.0$	+ 4.5
10,000 Ohms	+ 7.0	+ 3.5	+ 2.0	0	$\pm 1.0$	$\pm 2.5$	+ 5.5
100,000 Ohms	+ 8.0	+ 4.0	- 2.0	0	$\pm 1.5$	$\pm 3.0$	+ 6.0
1 Megohm	+ 10.0	+ 5.0	- 2.5	0	$\pm 1.5$	$\pm 3.5$	+ 7.5

For "S", "A", "B" and "DB" tapers multiply percentage figures shown above by 1.25.

## Taper Data

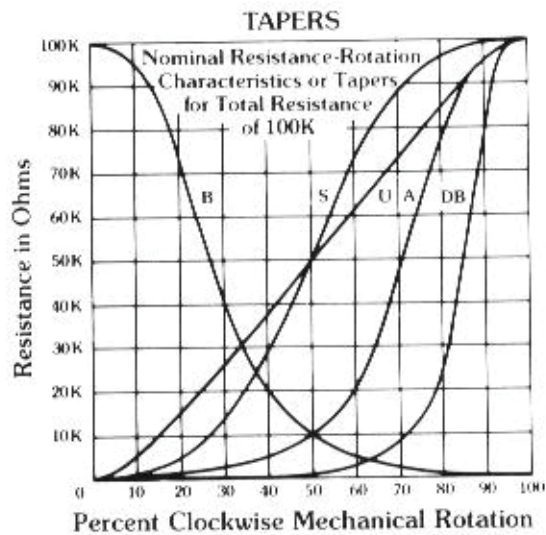

Tapers A, DB, S and U are measured between the wiper and the counter-clockwise terminals, taper B is measured between the wiper and the clockwise terminals.

## END RESISTANCE

TAPER	MINIMUM RESISTANCE BETWEEN TERMINALS 1 and 2	MINIMUM RESISTANCE BETWEEN TERMINALS 2 and 3
U & S	<b>1</b>	<b>1</b>
A	<b>1</b>	<b>2</b>
B	<b>2</b>	<b>1</b>
DB	<b>3</b>	<b>2</b>

- 1** Less than .004% of total resistance, or less than 15 ohms, whichever is greater.
- 2** Less than 1% of total resistance, or less than 15 ohms, whichever is greater.
- 3** Less than 15 ohms.



# Hot-Molded Panel Potentiometers

## Explanation of Part Numbers

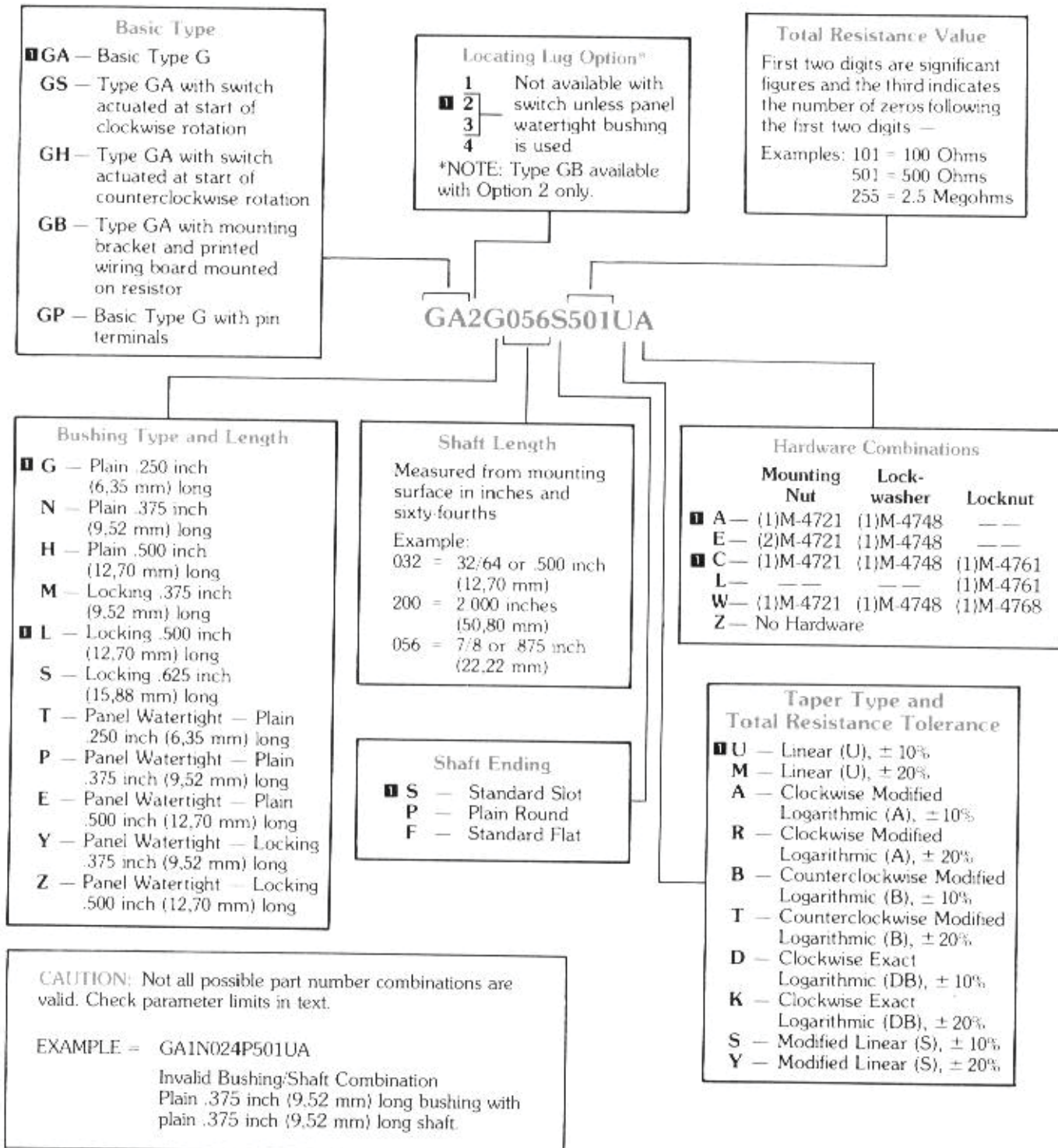

**THESE CONFIGURATIONS ARE AVAILABLE IN STANDARD VALUES FROM STOCK AT ELECTRONIC DISTRIBUTORS.**

## Distributor Stocked Potentiometers

## OEM Standard Components

Resistance (ohms)	Code	GA	
		"U" Taper Only	
		GA2G 056S	GA2L 040S
100	101	A	A
1000	102	A	A
10000	103	A	A
100000	104	A	A
1000000	105	A	A
150	151	—	—
1500	152	—	—
15000	153	—	—
150000	154	—	—
200	201	—	—
2000	202	—	—
20000	203	—	—
200000	204	—	—
2000000	205	A	—
250	251	A	A
2500	252	A	A
25000	253	A	A
250000	254	A	A
2500000	255	A	A
500	501	A	A
5000	502	A	A
50000	503	A	A
500000	504	A	A
5000000	505	A	A

A = Available from Distributor Stock.

— = Available as a Special Order only. Contact factory for information.

NOTE: For MIL-R-94 specifications, reference pages #45-46.

Basic Type		GA, GB, GP		
Bushing Length, Inches		1/4		
Bushing Type		Plain		
Shaft Length, Inches		Non-Standard		
Plain Ending		1/2, 3/8, 1/2, 3/4		
Slotted Ending		3/8, 1/2, 3/4, 1, 1 1/4		
Flatted Ending		Non-Standard		
Resistance (ohms)	Code	Taper		
		"U"	"A"	"B"
100	101	A	*	*
1000	102	A	A	A
10000	103	A	A	A
100000	104	A	A	A
1000000	105	A	—	—
150	151	—	*	*
1500	152	A	A	A
15000	153	A	—	—
150000	154	—	—	—
200	201	A	*	*
2000	202	A	A	A
20000	203	A	A	A
200000	204	A	—	—
2000000	205	A	—	—
250	251	A	*	*
2500	252	A	A	A
25000	253	A	A	A
250000	254	A	A	A
2500000	255	A	—	—
500	501	A	A	A
5000	502	A	A	A
50000	503	A	A	A
500000	504	A	A	A
5000000	505	A	*	*

A = Available as OEM Component

— = Available as a Special Order only. Contact factory for information.

\* = Not Available.

## Cross Reference Guide

Description	A-B Type G	Clarostat Type 382	PEC Type S	Bourns Type 3862	Tokyo-Cosmos Type RV12Y
Single/Lug Terminal	■	■	■	■	■
Single/Pin Terminal	■	■	■	■	■
Single/Side Adj. Pin Terminal	■	■			■
Single/Rotary Switch	■				
MIL RV6	■	■	■		

■ = Available.

## Ordering Information

1. Type (GA, GB, GH, GP or GS).
2. Taper.
3. Total resistance value in ohms.
4. Bushing type (plain, locking, shaft watertight, or panel and shaft watertight).
5. Bushing length in inches.
6. Shaft ending (plain, slotted or flatted).
7. Shaft length from mounting surface in inches.
8. Switch required?
9. Locating lug option (1,2,3 or 4).
10. Mounting hardware (A-B Standard or Other).
11. Part number you have assigned, if any.
12. Marking required on the part.
13. Special features.\*

\*Forward complete detailed specifications to the factory.



## DIMENSIONS

### Type GA Resistor with Lug Terminals

#### Plain Bushing

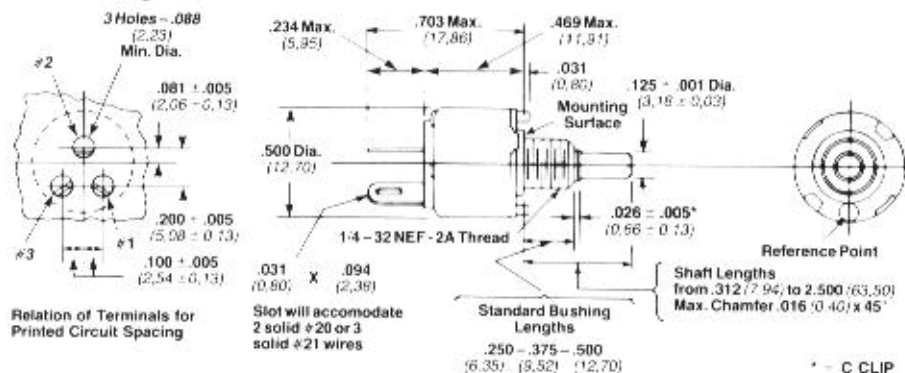

#### Locking Bushing

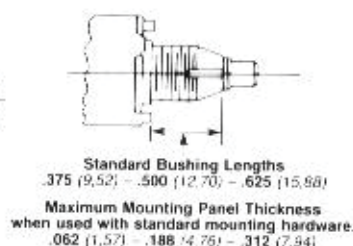

### Type GP Resistor with Pin Terminals

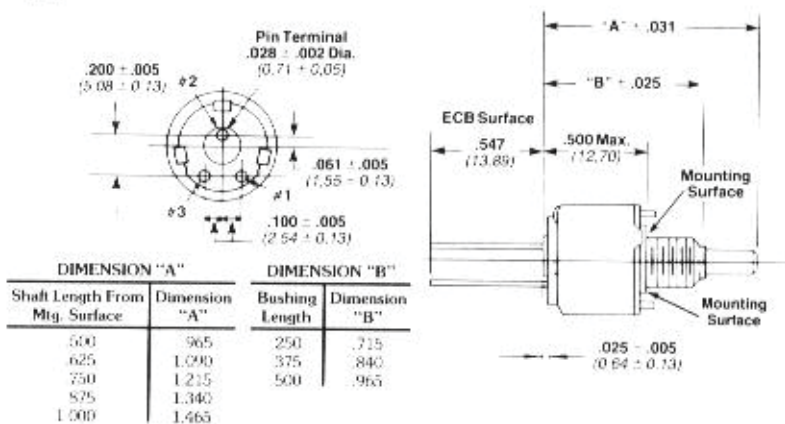

### Resistor Connections

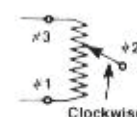

Basic dimensions in inches.  
Dimensions shown in parentheses are in millimeters.

**TOLERANCES**  
Dimensional tolerance  $\pm .016$  (0.40)  
Angular tolerance  $\pm 5^\circ$   
Except as specified.

**NOT TO SCALE**

### Shaft Endings

#### Screwdriver Slotted

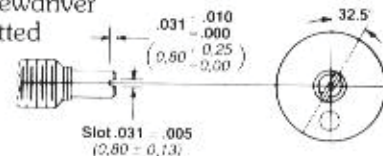

Slot .031 ± .005 (0.80 ± 0.13)

Shaft in Extreme Counterclockwise Position  
Screwdriver Slot in line with Movable Contact

#### Flatted

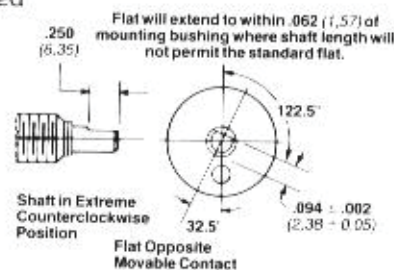

### Panel Watertight Bushing

#### Plain

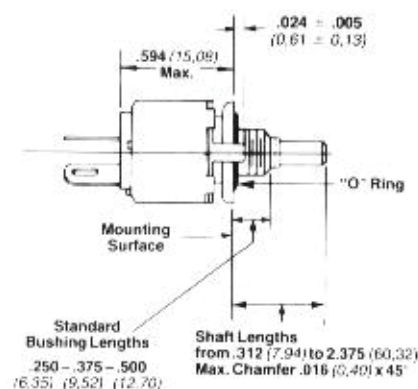

#### Locking



### Lug Options

#### Plain and Locking Bushing

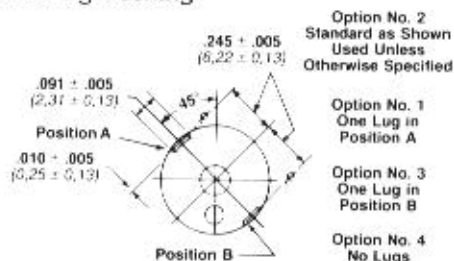

### Panel Watertight Bushing

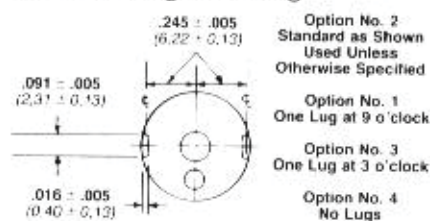

# DIMENSIONS

## Type GS, GH Resistor with Switch

Plain Bushing

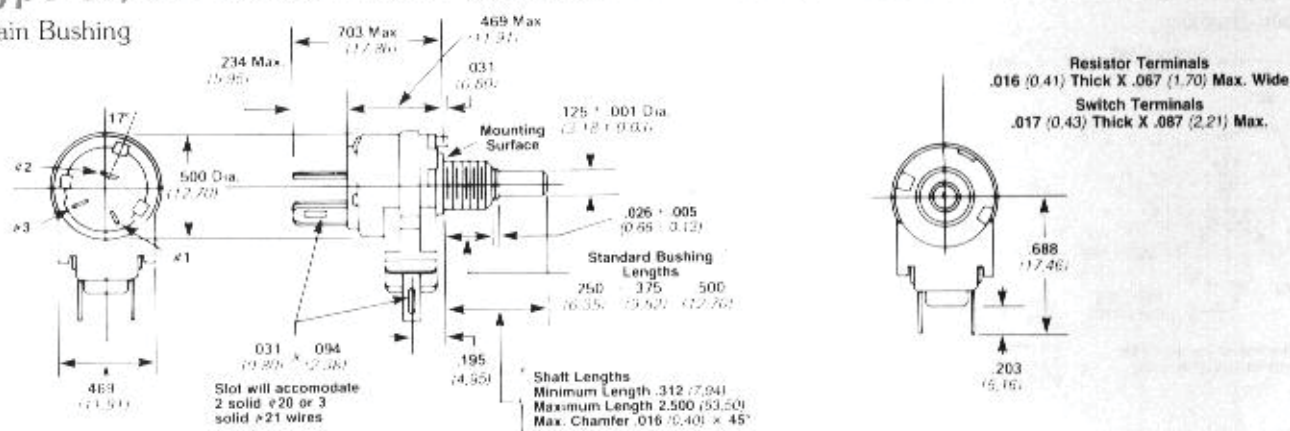

## Switches

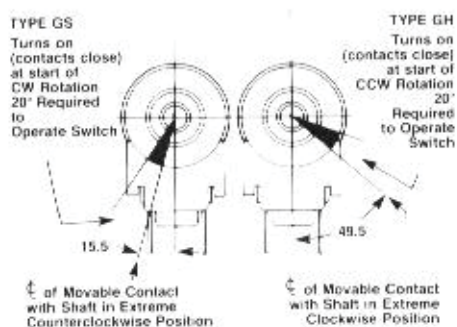

## Resistor Connections

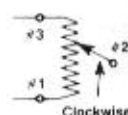

Basic dimensions in inches. Dimensions shown in parentheses are in millimeters.

### TOLERANCES

Dimensional tolerance ±.016 (0.40)

Angular tolerance ±5°

Except as specified.

NOT TO SCALE

## Panel Watertight Bushing

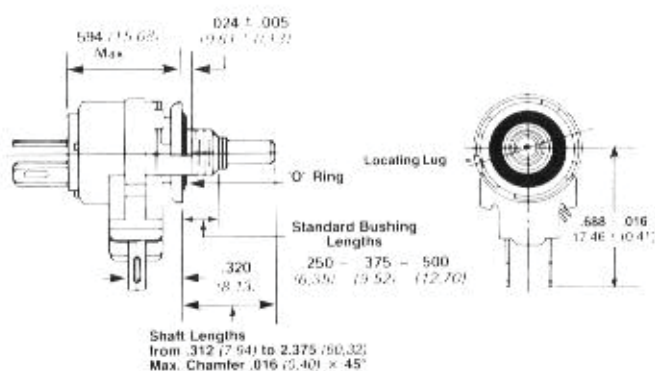

## Shaft Endings

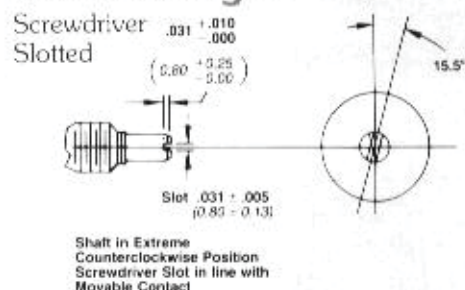

### Flatted

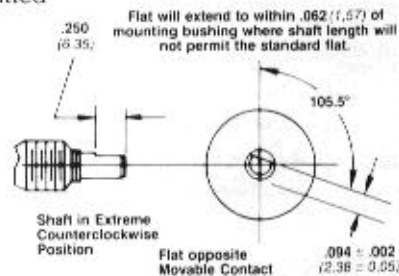

## Lug Options

Plain Bushing

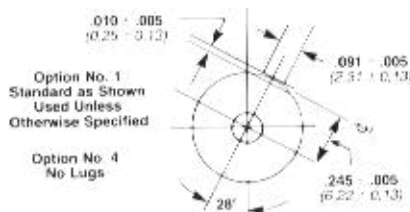

## Panel Watertight Bushing

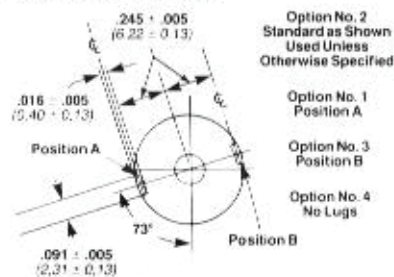



## DIMENSIONS

## Mounting Holes

TYPE GA or GP

Standard Potentiometer

Panel Watertight Potentiometer

TYPE GS or GH

Standard Potentiometer

Panel Watertight Potentiometer

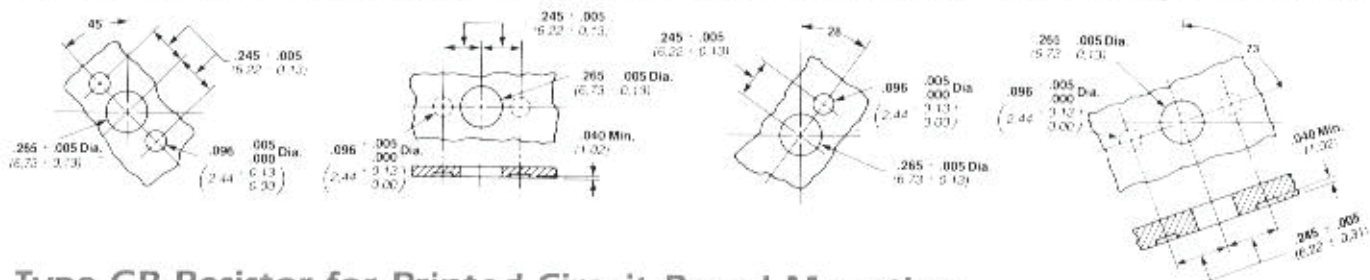

## Type GB Resistor for Printed Circuit Board Mounting

Plain Bushing

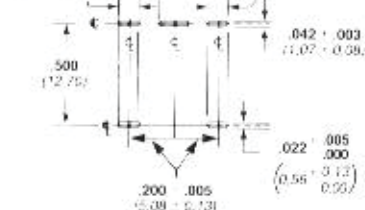
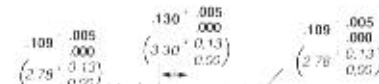
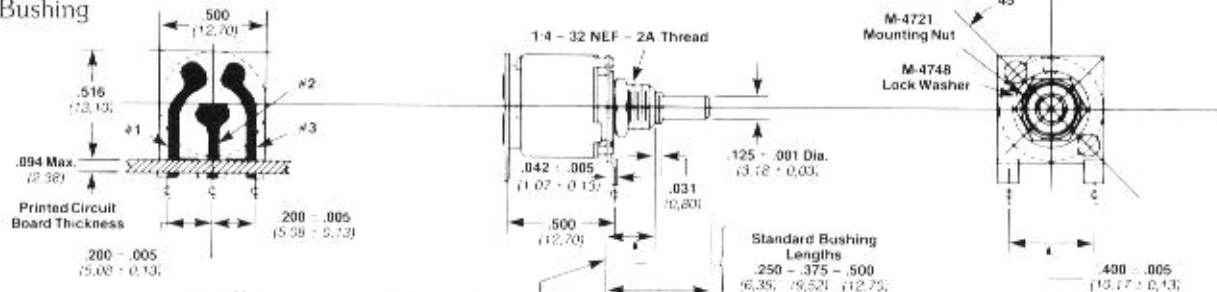

Relation of Terminals for Printed Circuit Spacing

Reference Plane for Bushing and Shaft Length Measurement

Standard Bushing Lengths  
.250 - .375 - .500  
(6.35 - 9.52 - 12.70)Shaft Lengths  
from .312 (7.94) to 2.500 (63.50)  
Max. Chamfer .016 (0.41), x 45°

Locking Bushing

Standard Bushing Lengths  
.375 - .500 - .625  
(9.52 - 12.70 - 15.88)

Slots Randomly Located

## Shaft Endings

Screwdriver Slotted

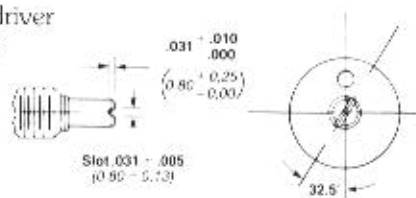
Shaft in Extreme Counterclockwise Position  
Screwdriver Slot in Line with Movable Contact

Flatted

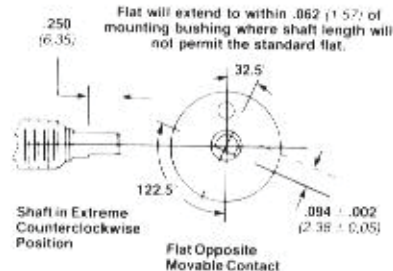

## Hardware

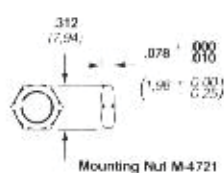

Mounting Nut M-4721

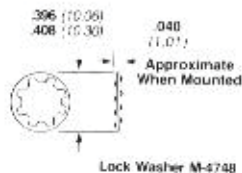

Lock Washer M-4748

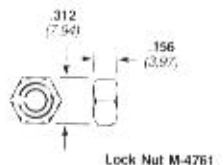

Lock Nut M-4761

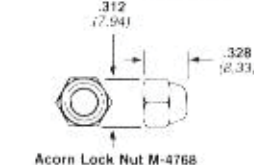

Acorn Lock Nut M-4768

Can be used in place of Lock Nut M-4761 provided shaft extension beyond the bushing does not exceed .062 (1.57)

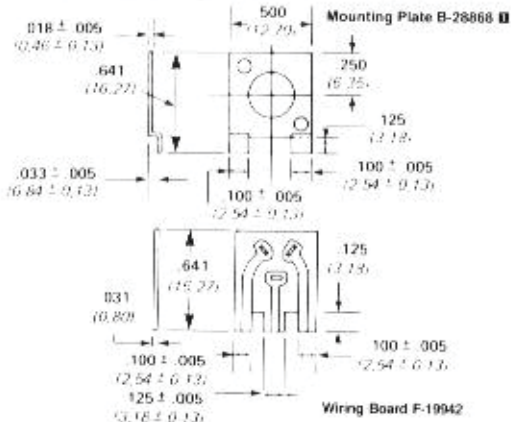

Mounting Plate B-28868

Wiring Board F-19942

If field assembled lug option no. 2 is required.