

MICRO SWITCH™ GLS Series

Miniature Global Limit Switch



DESCRIPTION

GLS miniature limit switches are designed to provide a complete range of globally approved products. These rugged and reliable limit switches are often suitable for most industrial applications.

Side rotary versions offer a unique dual-bearing design which prevents side loading during application. The compact housing size makes them often ideal for mounting where space is at a premium. The extensive product range offers the user a choice of plastic, metal, and three conduit version housing, which are all mounting compatible to EN50047. A wide range of actuator and circuitry options makes it easy for the user to customize a switch to the particular application.

FEATURES

- Double break, direct-opening contacts conform to IEC 60947-5-1-3 (except on 2NO models)
- Dual bearing design on side rotary shaft
- Choice of rugged metal or double-insulated plastic housings
- Full range of actuator heads and levers
- Snap action, slow action basic switches
- Gold contact versions available
- Galvanically isolated contacts (Form Zb)
- Sealing up to IP67/NEMA 4
- CE, UL, CSA, CCC
- -40 °C [-40 °F] standard construction for side rotary and plunger styles

POTENTIAL APPLICATIONS

- Elevators and moving stairs
- Scissor/platform lifts
- Material handling
- Packaging machinery
- Agricultural and machine tool equipment



LOW-ENERGY SWITCHING

In today's demanding age of low-energy controls, electromechanical switches are frequently used to interface directly with PLCs and other low-energy devices. To accommodate this requirement, GLS offers a gold-plated version of the standard basic switch. This improves reliability of switching at low currents and voltages by protecting the contact surfaces from contamination during operation or storage prior to use. Standard silver contacts have the disadvantage in that the contact surface may tarnish under certain environmental conditions (e.g., presence of moisture). Low energy basic switches are rated as follows:

Operating Voltage U_e 1 Vac/Vdc to 50 Vac/Vdc
 Operating Current I_e 1 microamp to 100 mA

Electrical Ratings

IEC 947-5-1 / EN 90947-5-1									
Designation & Utilization Category		Rated operational current I_e (A) at rated operational voltage U_e						VA Rating	
		120 V	240 V	380 V	480 V	500 V	600 V	Make	Break
AC15	A600	6	3	1.9	1.5	1.4	1.2	7200	720
AC15	A300	6	3	–	–	–	–	7200	720
AC15	B300	3	1.5	–	–	–	–	3600	360
AC14	D300	0.6	0.3	–	–	–	–	432	72
		125 V	250 V						
DC13	Q300	0.55	0.27					69	69
DC13	R300	0.22	0.1					28	28

BENEFITS

- Forced opening of the normally closed circuitry in the event of contacts welding (on all models except 2NO)
- Meets globally accepted mounting standards
- Prevents side loading
- Design flexibility
- Can be applied for both logic level and power-duty loads
- Each contact throw can accept a different voltage (SPDT versions)
- Suitable for outdoor environments
- Designed to IEC electrical standard for world-wide use

GLC EN 50047 Metal standard

Technical data

Mechanical life	up to 15 million operations
Degree of protection	IP67 (wobble IP66) NEMA/UL type 1, 4, 12, 13
Temperature range	Operating : -40 °C to 85 °C [-40 °F to 185 °F] Storage : -40 °C to 85 °C -40 °F to 185 °F
Approvals	IEC 60947-5-1 EN 60947-5-1 AC15 A300 DC13 Q300 UL & CSA
Vibration	10 g conforming to IEC 68-2-6
Shock	50 g conforming to IEC 68-2-27 Terminal marking to EN 50013

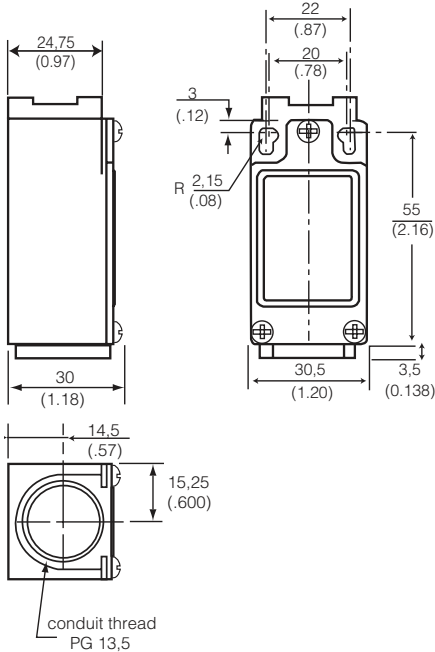

Conduit thread

- A** = 1/2 in NPT adaptor
- B** = PG 13,5
- C** = 20 mm

Ordering :

GLC

X

Snap-Action Contacts

1 NORMALLY CLOSED / 1 NORMALLY OPEN

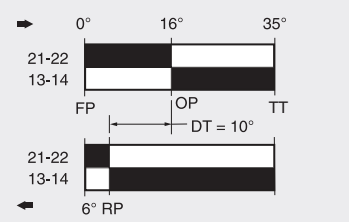
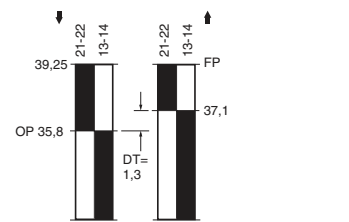
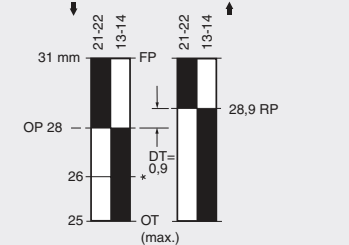
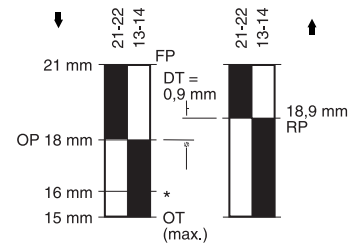
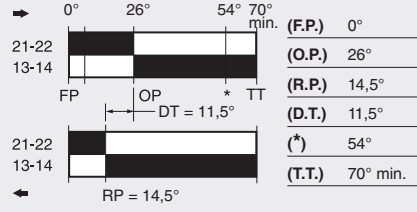
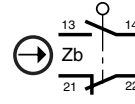

Slow-Action Contacts

BREAK-BEFORE-MAKE

1 NORMALLY CLOSED /
1 NORMALLY OPEN

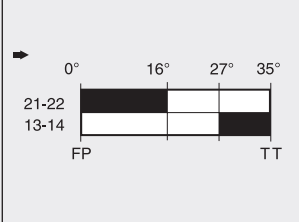
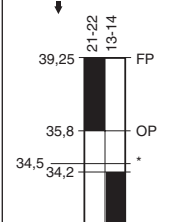
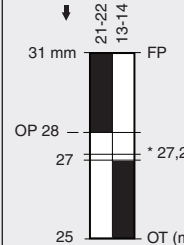
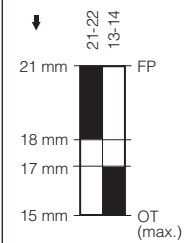
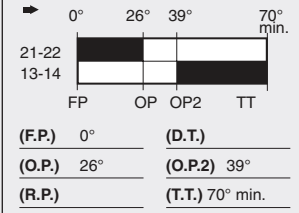
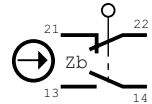

* Point from which the positive opening is assured

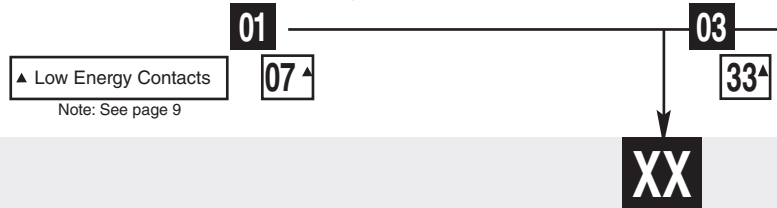

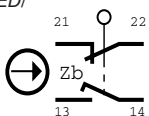
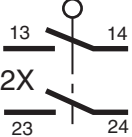
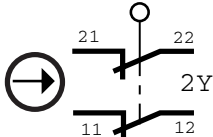
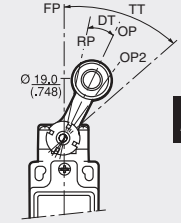
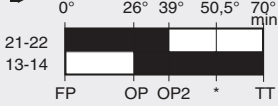
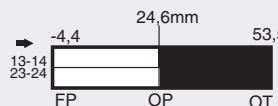
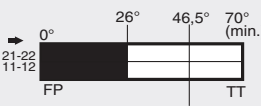
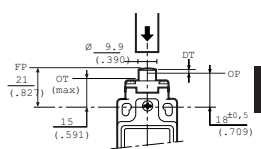
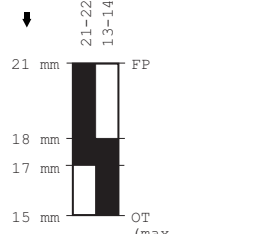
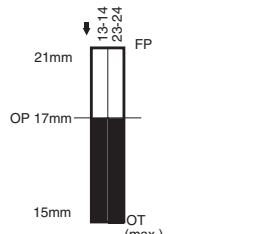
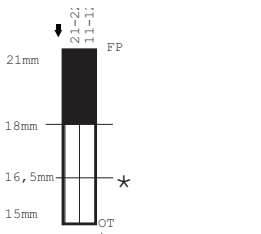
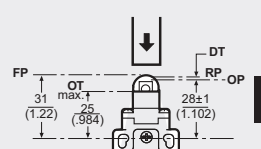
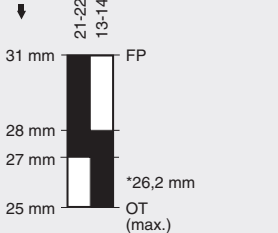
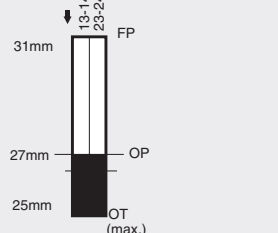
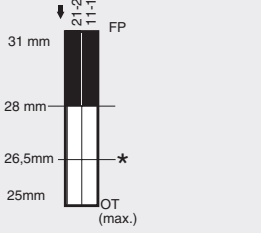
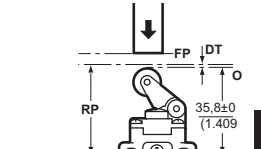
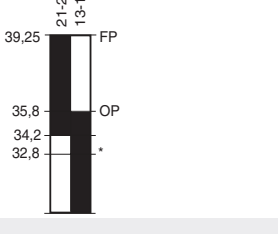
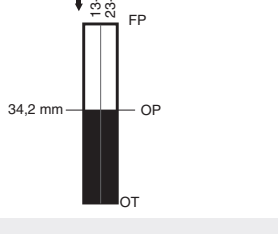
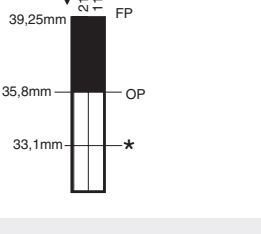
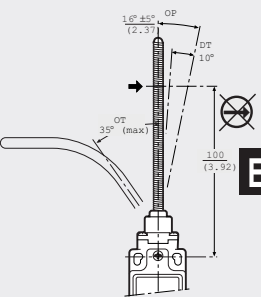
Slow-Action Contacts <i>MAKE BEFORE BREAK</i> 1 NORMALLY CLOSED/ 1 NORMALLY OPEN	Slow-Action Contacts 2 NORMALLY OPEN	Slow-Action Contacts 2 NORMALLY CLOSED	Operating Torque	Actuator Types
 21-22 13-14 Zb	 13 14 2X 23 24	 21 22 11 12	0,330 Nm [2.90 lb]	 A1B Side Rotary, Metal Roller
 0° 26° 39° 50,5° 70° min. FP OP OP2 * TT (F.P.) 0° (D.T.) (O.P.) 26° (O.P.2) 39° (R.P.) (T.T.) 70° min. (*) 50,5	 -4,4 24,6mm 53,5 13-14 23-24 FP OP OT (F.P.) 0° (O.P.) 36° (O.T.) 61° to 75°	 0° 26° 46,5° 70° (min.) 21-22 11-12 FP TT (F.P.) 0° (D.T.) (O.P.) 26° (*) 46,5° (R.P.) (O.T.) 70° min.	16,0 Nm [3.60 lb]	 B Top Pin Plunger
 21 mm 21-22 13-14 FP 18 mm 17 mm 15 mm OT (max.)	 21mm 13-14 23-24 FP OP 17mm 15mm OT (max.)	 21mm 21-22 11-12 FP 18mm 16,5mm * 15mm OT (max.)	16,0 Nm [3.60 lb]	 C Top Roller Plunger
 31 mm 21-22 13-14 FP 28 mm 27 mm *26,2 mm 25 mm OT (max.)	 31mm 13-14 23-24 FP OP 27mm 25mm OT (max.)	 31 mm 21-22 11-12 FP 28 mm 26,5mm * 25mm OT (max.)	9,5 Nm [2.10 lb]	 D Top Roller Lever
 0° 16° 27° 35° 21-22 13-14 FP TT	 0° 27° 35° 13-14 23-24 FP OP OT (MAX)	 0° 16° 35° 21-22 11-12 FP TT (MAX)	0,1 Nm [0.90 lb]	 E7B Coil Wobble Stick

04

34^

05

35^

06

36^

XXX

GLD EN 50047 Double insulated standard

Technical data

Mechanical life	up to 15 million operations
Degree of protection	IP66, IP67 NEMA/UL type 1, 4X (indoor use), 12, 13
Temperature range	Operating : -40 °C to 85 °C [-40 °F to 185 °F] Storage : -40 °C to 85 °C -40 °F to 185 °F
Approvals	IEC/EN 60947-5-1 EN 60947-5-1 AC15 A300 DC13 Q300 UL & CSA
Vibration	10 g conforming to IEC 68-2-6
Shock	50 g conforming to IEC 68-2-27 Terminal marking to EN 50013

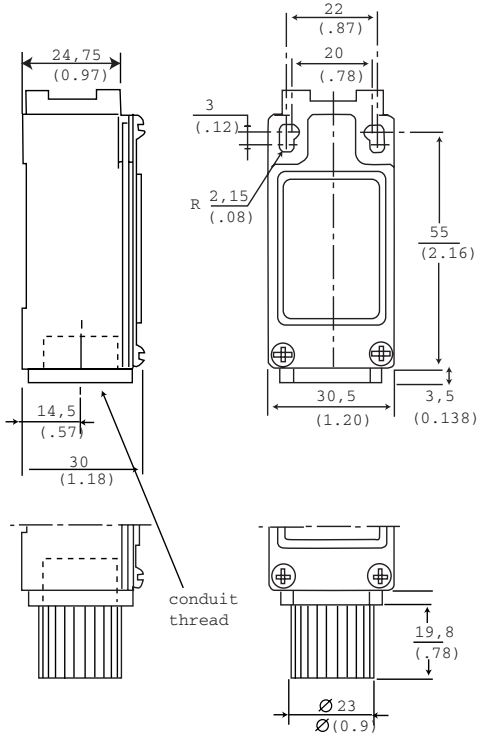

Conduit thread

- A** = 1/2 in NPT adaptor
- B** = PG 13,5
- C** = 20 mm

Ordering :

GLD

X

XX

Snap-Action Contacts 1 NORMALLY CLOSED / 1 NORMALLY OPEN

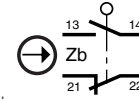

— Circuit closed
* Positive opening to IEC/EN 60947-5-1-3

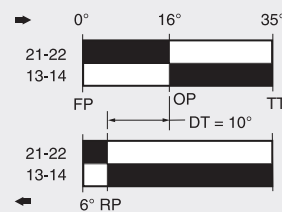
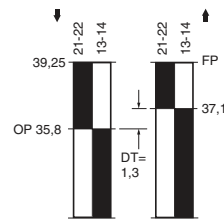
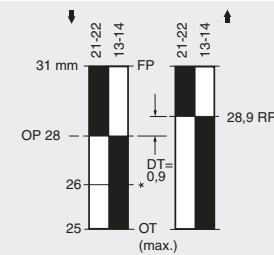
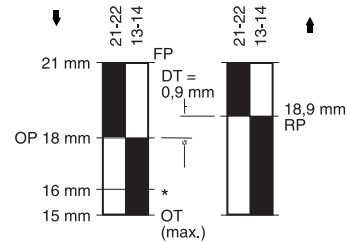
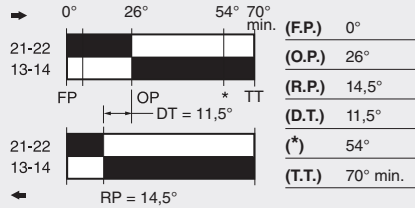

Slow-Action Contacts BREAK-BEFORE-MAKE 1 NORMALLY CLOSED / 1 NORMALLY OPEN

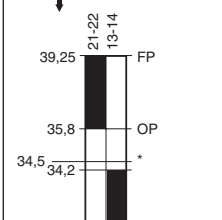
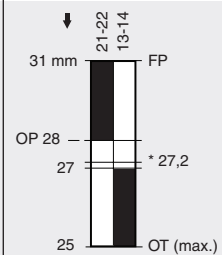
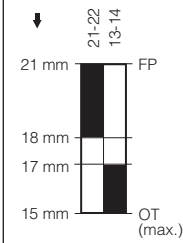
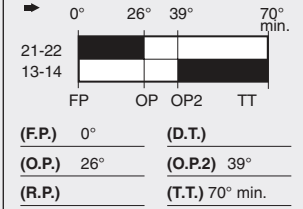
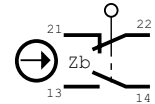

* Point from which the positive opening is assured

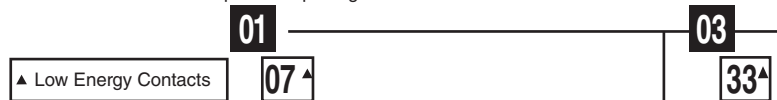

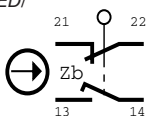
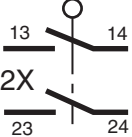
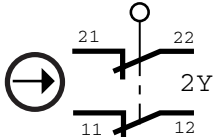
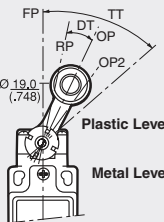
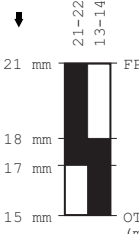
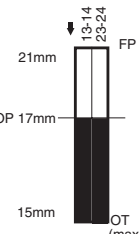
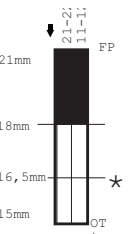
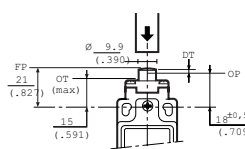
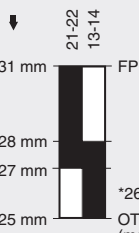
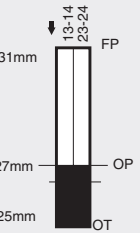
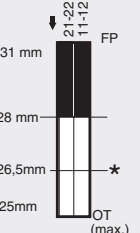
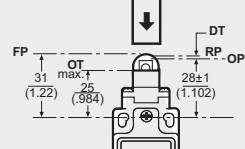
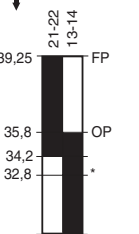
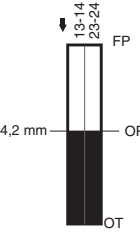
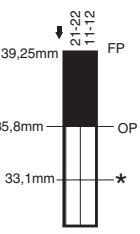
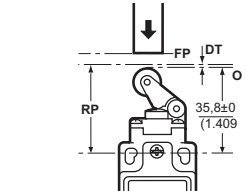
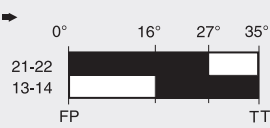
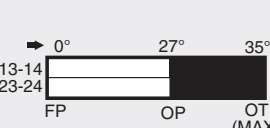
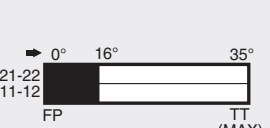
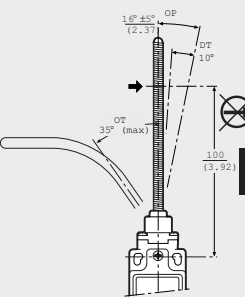
Slow-Action Contacts <i>MAKE BEFORE BREAK</i> 1 NORMALLY CLOSED/ 1 NORMALLY OPEN	Slow-Action Contacts 2 NORMALLY OPEN	Slow-Action Contacts 2 NORMALLY CLOSED	Operating Torque	Actuator Types
 0° 26° 39° 50,5° 70° min. 21-22 13-14 FP OP OP2 * TT (F.P.) 0° (D.T.) (O.P.) 26° (O.P.2) 39° (R.P.) (T.T.) 70° min. (*) 50,5	 24,6mm 53,5 13-14 23-24 FP OP OT (F.P.) 0° (O.P.) 36° (O.T.) 61° to 75°	 0° 26° 46,5° 70° (min.) 21-22 11-12 FP TT (F.P.) 0° (D.T.) (O.P.) 26° (*) 46,5° (R.P.) (O.T.) 70° min.	0,330 Nm [2.90 lb]	 A1A A1B
 21 mm FP 18 mm 17 mm 15 mm OT (max.)	 21mm FP OP 17mm 15mm OT (max.)	 21mm FP 18mm 16,5mm * 15mm OT (max.)	16,0 Nm [3.60 lb]	 B
 31 mm FP 28 mm 27 mm *26,2 mm 25 mm OT (max.)	 31mm FP 27mm OP 25mm OT (max.)	 31 mm FP 28 mm 26,5mm * 25mm OT (max.)	16,0 Nm [3.60 lb]	 C
 39,25 FP 35,8 OP 34,2 * 32,8	 34,2 mm OP OT	 39,25mm FP 35,8mm OP 33,1mm *	9,5 Nm [2.10 lb]	 D
 0° 16° 27° 35° 21-22 13-14 FP TT	 0° 27° 35° 13-14 23-24 FP OP OT (MAX)	 0° 16° 35° 21-22 11-12 FP TT (MAX)	0,1 Nm [0.90 lb]	 E7B

04

34^

05

35^

06

36^

XXX

GLE EN 50047 Compatible 3 conduit metal standard

Technical data

Mechanical life up to 15 million operations

Degree of protection IP67 (wobble IP66)
NEMA/UL type 1, 4, 12, 13

Temperature range Operating : -40 °C to 85 °C
[-40 °F to 185 °F]
Storage : -40 °C to 85 °C
-40 °F to 185 °F

Approvals IEC 60947-5-1
EN 60947-5-1
AC15 A300
DC13 Q300
UL & CSA

Vibration 10 g conforming to IEC 68-2-6

Shock 50 g conforming to IEC 68-2-27
Terminal marking to EN 50013

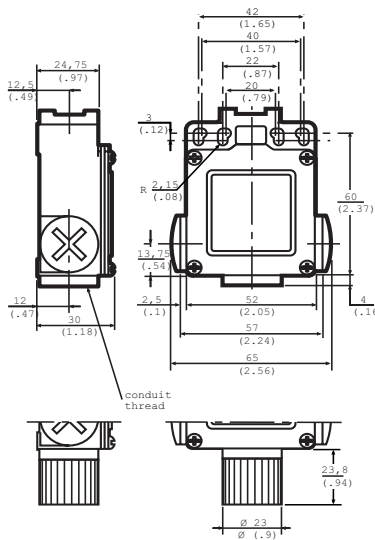

Conduit thread

A = 1/2 in NPT adaptor

B = PG 13,5

C = 20 mm

Ordering :

GLE **X**

Snap-Action Contacts

1 NORMALLY CLOSED/
1 NORMALLY OPEN

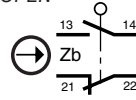

█ Circuit closed
* Positive opening to IEC/EN 60947-5-1-3

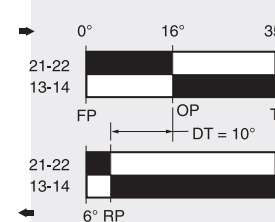
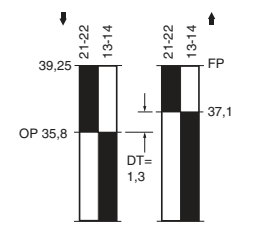
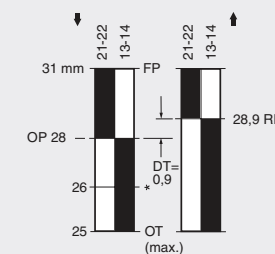
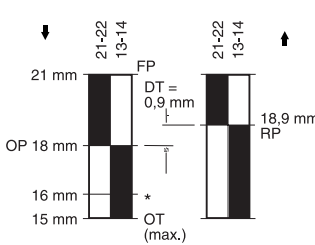
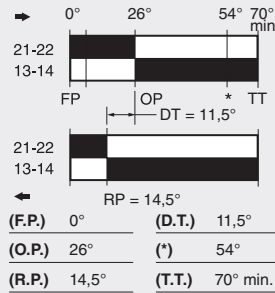

Slow-Action Contacts

BREAK-BEFORE-MAKE
1 NORMALLY CLOSED /
1 NORMALLY OPEN

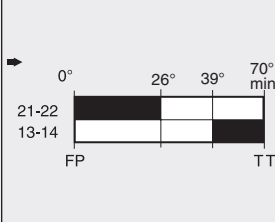
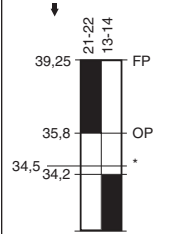
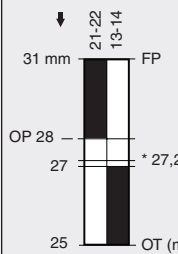
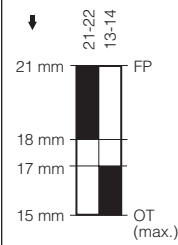
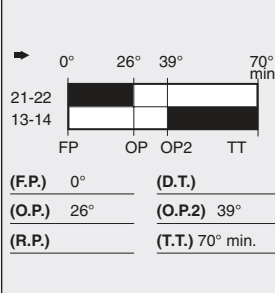
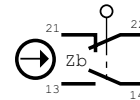

Slow-Action Contacts

MAKE BEFORE BREAK
1 NORMALLY CLOSED/
1 NORMALLY OPEN

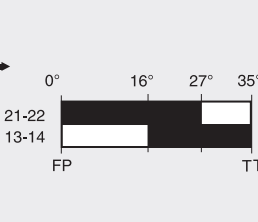
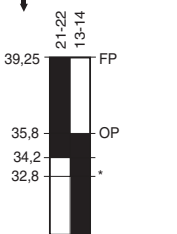
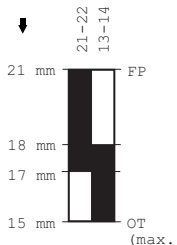
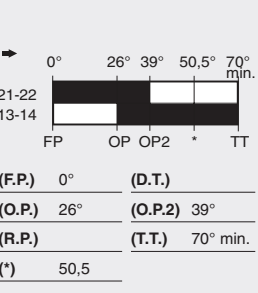
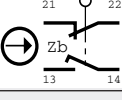

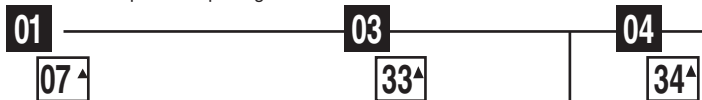

* Point from which the positive opening is assured

▲ Low Energy Contacts
Note: See page 9

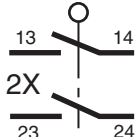
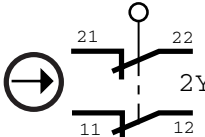
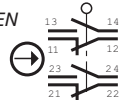

XX

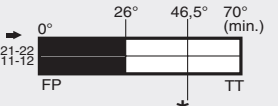
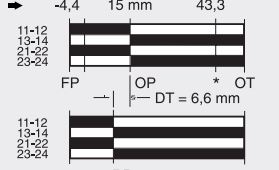
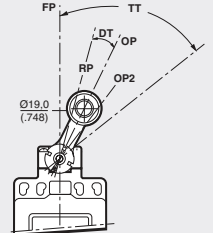
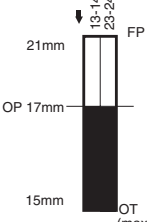
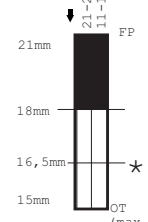
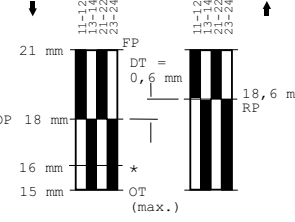
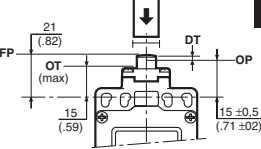
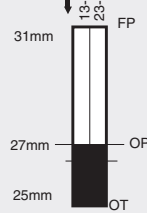
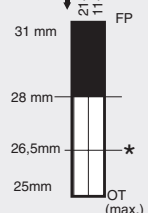
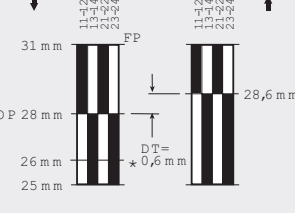
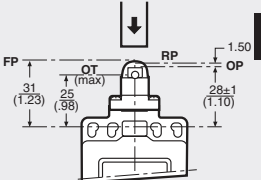
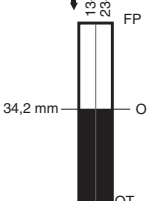
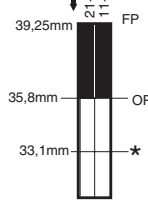
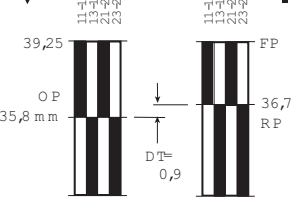
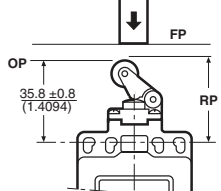
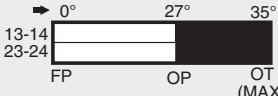
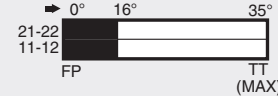
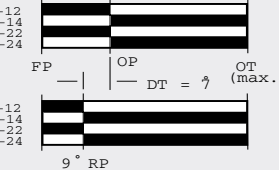
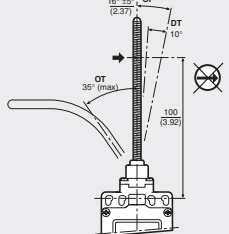
Slow-Action Contacts 2 NORMALLY OPEN 	Slow-Action Contacts 2 NORMALLY CLOSED 	Snap-Action Contacts DOUBLE POLE 2 2 NORMALLY CLOSED/ 2 NORMALLY OPEN 	Operating torque/force SPDT DPDT	Actuator Types
 <p>(F.P.) 0° (O.P.) 36° (O.T.) 61° to 75°</p>	 <p>(F.P.) 0° (D.T.) (O.P.) 26° (*) 46.5° (R.P.) (O.T.) 70° min.</p>	 <p>(F.P.) 0° (*) 54° (O.P.) 26° (O.T.) 61° to 75° (R.P.) 180° (D.T.) 8°</p>	0,330 Nm [2.90 lb] 0,120 Nm [1.10 lb] 0,165 Nm [1.50 lb] GLE only	 <p>A1B Side Rotary, Metal Roller</p>
			16,0 Nm [3.60 lb] 16,0 Nm [3.60 lb] 13,0 Nm [2.90 lb] GLE only	 <p>B Top Pin Plunger</p>
			16,0 Nm [3.60 lb] 16,0 Nm [3.60 lb] 13,0 Nm [2.90 lb] GLE only	 <p>C Top Roller Plunger</p>
			9,5 Nm [2.10 lb] 11,0 Nm [2.4 lb] 9,0 Nm [1.9 lb] GLE only	 <p>D Top Roller Lever</p>
			0,1 Nm [0.90 lb] 1,3 Nm [0.29 lb] 1,1 Nm [0.25 lb] GLE only	 <p>E7B Coil Wobble Stick</p>

05

35^Δ

06

36^Δ

24

32^Δ

XXX

Additional lever types

For use with all Side Rotary Head Styles.

Figure 1 illustrates miniature product lever types conforming to EN 50047 while **Figure 2** illustrates standard product lever types with conform to EN 50041. All dimensions are in mm/inches).

GLC, GLD, GLE (EN 50047)

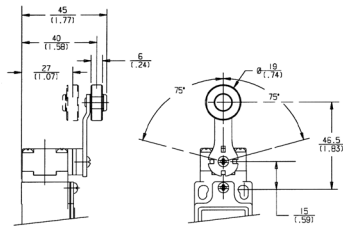

Side Rotary Roller Lever; A1A Plastic Roller
A1B Metal Roller

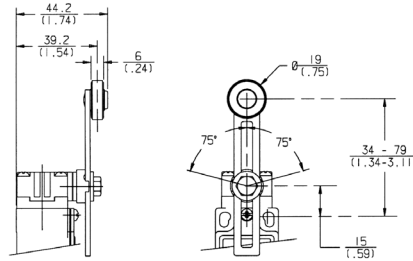

Side Rotary Adjustable Lever; A2A Plastic Roller; A2B Metal Roller

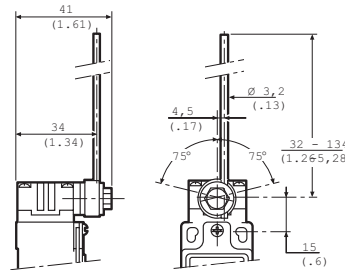

Side Rotary Adjustable Rod
A4J Metal Rod Head

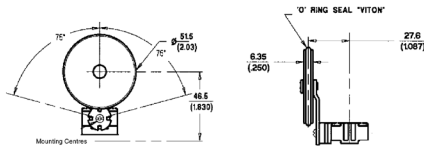

A1Y Large Fixed Plastic Roller
(Suitable for Elevator Applications)

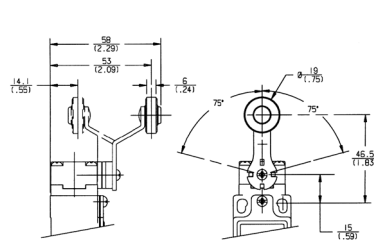

Offset Side Rotary Roller Lever; A5A Plastic Roller; A5B Metal Roller Head

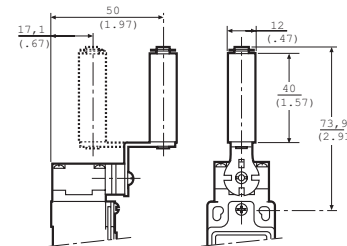

Side Rotary Conveyor Lever
A9A Ceramic Roller

Replacement Parts - basic switches

Body type	Basic Switch									
	01	02	03	04	05	06	12	13	20	24
GLC	GLZ301		GLZ303	GLZ304		GLZ306				
GLD	GLZ301		GLZ303	GLZ304		GLZ306				
GLE	GLZ301		GLZ303	GLZ304		GLZ306				GLZ324

Sensing and Control

Honeywell

1985 Douglas Drive North
Golden Valley, MN 55422 USA

sensing.honeywell.com

Honeywell

107147-13-EN IL50 GLO
June 2013

Copyright © 2013 Honeywell International Inc. All rights reserved.