

# HONEYWELL

*See full Datasheet below...*

**onlinecomponents.com**  
*THE ONLINE DISTRIBUTOR OF ELECTRONIC COMPONENTS*

**BUY NOW**

 **MASTER**<sup>TM</sup>  
ELECTRONICS

**BUY NOW**

masterelectronics.com & onlinecomponents.com  
are **authorized** e-commerce distributors  
of electronic components.

## MICRO SWITCH Miniature Industrial Limit Switch

GLL Series

002310

Issue 4

Datasheet



### DESCRIPTION

Honeywell provides a wide selection of industrial limit switches for machinery and equipment on indoor and outdoor applications. When the solution for the application is a small global limit switch, Honeywell offers the GLL Series miniature industrial limit switch. The GLL Series switches are designed with global certifications for worldwide use. With an integral contact block, the design also provides a double-insulated thermoplastic housing and conforms to the EN50047 mounting pattern with IP and NEMA environmental sealing. A wide variety of linear and rotary actuators is available as well as contact block options to satisfy many applications. All normally closed contacts are positive opening ➡.

### VALUE TO CUSTOMERS

- Designed to EN50047 standards
- AC15, A600 and DC13, Q300 control circuit electrical ratings for world-wide acceptance
- Wide range of actuators and circuitry options in same package
- CCC, CE, CSA, and cULus certifications for global acceptance

### FEATURES

- Ten different actuator heads, five different contact options, and two different conduits
- Designed to EN50047 standard
- Double insulated plastic housing
- Integral threaded conduit of 0.5 NPT or 20 mm
- Positive opening normally closed contacts to IEC 60947-5-1-3 ➡
- Certified for global applications; CE, cULus, CSA, CCC
- Galvanically isolated poles or throws [Zb] within contact block
- Double break snap action or slow action contacts
- Hinge cover with single fastener for easy wiring access
- IP66 environmental sealing for indoor or outdoor applications
- ROHS compliant

### POTENTIAL INDUSTRIAL APPLICATIONS

- Aerial platforms/Lifts
- Elevators/Escalators
- Industrial Doors/Gates
- Packaging equipment

### DIFFERENTIATION

- Double insulated thermoplastic limit switch with integral contact block
- Cost effective EN50047 type limit switch with world-wide availability

### PORTFOLIO

The GLL Series global limit switches are a segment of the Honeywell industrial global limit switch offering. The global limit switch products also include the GLA Series, the miniature GLC, GLD, and GLE Series, the NGC Series, and SZL-VL Series. In addition to the global limit switch series, Honeywell provides a comprehensive line of medium duty industrial limit switches (CE Series, E6/V6 Series, LS Series) and heavy-duty limit switches (HDLS Series).

# MICRO SWITCH Miniature Industrial Limit Switch, GLL Series

**Table 1. Specifications**

Characteristic	Parameter
Description	EN50047 industrial global limit switch
Certifications	CE, CCC, cULus, CSA
Conforming to standards	CE [EN60947-5-1]; CCC [GB 14048.5]; UL & cUL [UL508, File E37138]; CSA B44.1-04/ASME-A17.5-2004
Housing material	Thermoplastic reinforced with glass fiber
Actuators	Side rotary with fixed levers, side rotary with adjustable levers, side rotary with adjustable rod, top pin plunger, top roller plunger, top horizontal roller lever, top vertical roller lever
Conduit	0.5-14 NPT, 20 mm
Contact options*	1NC-1NO snap action, 1NC-1NO slow action break before make [BBM], 1NC-1NO slow action make before break [MBB], 2NC slow action. Poles or throws are electrically isolated [Zb]
Contact material	Silver alloy
Utilization category	AC-15, A600; DC-13, Q300
Rated operational voltage [Ue]	600 Vac, 250 Vdc
Rated operational current [Ie]	1.2 A, 0.27 A
Thermal current [Ith]	10 A
Rated insulation voltage [Ui]	600 V
Rated impulse withstand voltage (Uimp)	2500 V
Short Circuit Protective Device [SCPD] type & rating	Class J fuse, rated 10A, 600V
Sealing	IP66; NEMA 1, 12, 13
Operating temperature	-10 °C to 80 °C [14 °F to 176 °F]
Mechanical life	Up to 5 million operations
Vibration [w/o actuator]	10 g per IEC 60068-2-6
Shock [w/o actuator]	50 g per IEC 60068-2-27

\* All normally closed (NC) contacts are positive opening .

**Table 2. Electrical Specifications**

ac		dc	
A600 Ue Volts	AC-15 Ie Amps	Q300 Ue Volts	DC-13 Ie Amps
120	6	125	0.55
240	3	250	0.27
380	1.9		
480	1.5		
500	1.4		
600	1.2		

# MICRO SWITCH Miniature Industrial Limit Switch, GLL Series

Figure 1. Product Nomenclature

	<b>GLL</b> Switch Type	<b>A</b> Conduit	<b>01</b> Contact Block	<b>A</b> Head Style	<b>1B</b> Lever Style
<b>GLL Series</b> Miniature Industrial Limit Switch	<b>A</b>	0.5-14 NPT	<b>01</b>	<b>A</b>	<b>1B</b>
	<b>C</b>	20 mm	<b>03</b>	<b>B</b>	<b>1Y</b>
			<b>04</b>	<b>C</b>	<b>2B</b>
			<b>06</b>	<b>D</b>	<b>2Y</b>
			<b>07</b>	<b>F</b>	<b>3B</b>
				<b>4J</b>	

  

Switch Type	Conduit	Contact Block	Head Style	Lever Style
<b>A</b>	0.5-14 NPT	<b>01</b> 1NC/1NO snap action	<b>A</b> Side rotary (requires lever)	<b>1B</b> Fixed plastic (R 25 mm) Ø17 mm metal roller
<b>C</b>	20 mm	<b>03</b> 1NC/1NO slow action BBM	<b>B</b> Top pin plunger	<b>1Y</b> Fixed plastic (R 31,5 mm) Ø50 mm rubber roller
		<b>04</b> 1NC/1NO slow action MBB	<b>C</b> Top roller plunger	<b>2B</b> Adjustable metal (R20 mm to 75 mm) Ø17 mm metal roller
		<b>06</b> 2NC slow action	<b>D</b> Top horizontal roller plunger	<b>2Y</b> Adjustable metal (R31,5 mm to 75 mm) Ø50 mm rubber roller
		<b>07</b> 1NC/1NO snap action (gold-plated contacts)	<b>F</b> Top vertical roller plunger	<b>3B</b> Fixed plastic (R 31,55 mm) Ø17 mm metal roller
				<b>4J</b> Ø3mm adjustable metal rod (22 mm to 150 mm)

# MICRO SWITCH Miniature Industrial Limit Switch, GLL Series

## MICRO SWITCH GLL SERIES ORDER GUIDE/RECOMMENDED LISTINGS

Table 3. Side Rotary 25 mm lever with Ø17 mm metal roller

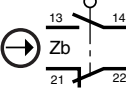
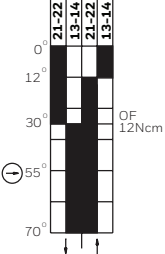
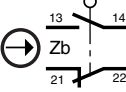
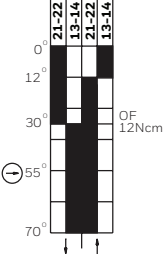
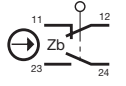
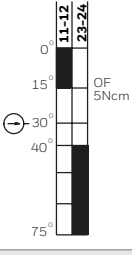
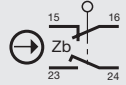
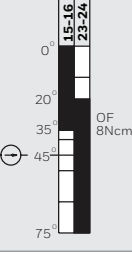
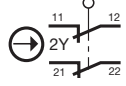
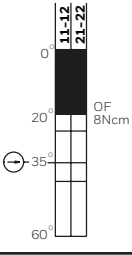
	Contacts	Contact Type	Contact Material	Operating Torque max. Ncm [in-lb]	Bar Chart <sup>1</sup>	0.5-14 NPT Conduit	20 mm Conduit
	1NC-1NO	Snap action 	silver	12 [1.06]		<b>GLLA01A1B</b>	<b>GLLC01A1B</b>
	1NC-1NO		gold-plated	12 [1.06]		<b>GLLA07A1B</b>	-
	1NC-1NO	BBM, slow action 	silver	5 [0.44]		<b>GLLA03A1B</b>	<b>GLLC03A1B</b>
	1NC-1NO	MBB, slow action 	silver	8 [0.71]		<b>GLLA04A1B</b>	<b>GLLC04A1B</b>
	2NC	Slow action 	silver	8 [0.71]		<b>GLLA06A1B</b>	<b>GLLC06A1B</b>

<sup>1</sup>Contact closed ■; Contact open □. \*Positive opening occurs.

# MICRO SWITCH Miniature Industrial Limit Switch, GLL Series

Table 4. Side Rotary 31,5 mm Lever with Ø17 mm Metal Roller

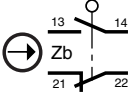
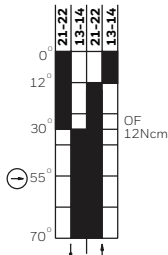
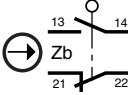
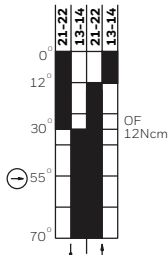
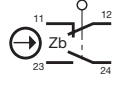
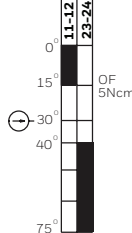
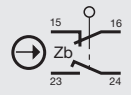
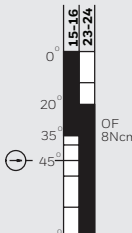
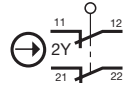
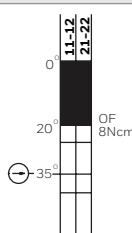
	Contacts	Contact Type	Contact Material	Operating Torque max. Ncm [in-lb]	Bar Chart <sup>1</sup>	0.5-14 NPT Conduit	20 mm Conduit
	1NC-1NO	Snap action 	silver	12 [1.06]		<b>GLLA01A3B</b>	-
	1NC-1NO		gold-plated	12 [1.06]		<b>GLLA07A3B</b>	-
	1NC-1NO	BBM, slow action 	silver	5 [0.44]		<b>GLLA03A3B</b>	<b>GLLC03A3B</b>
	1NC-1NO	MBB, slow action 	silver	8 [0.71]		<b>GLLA04A3B</b>	<b>GLLC04A3B</b>
	2NC	Slow action 	silver	8 [0.71]		<b>GLLA06A3B</b>	<b>GLLC06A3B</b>

<sup>1</sup>Contact closed ■; Contact open □. \*Positive opening occurs.

# MICRO SWITCH Miniature Industrial Limit Switch, GLL Series

Table 5. Side Rotary, 20 mm to 75 mm Adjustable Lever with Ø17 mm Metal Roller

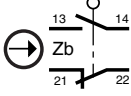
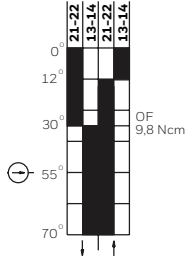
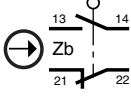
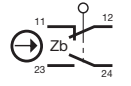
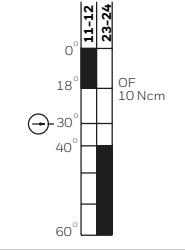
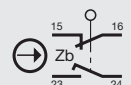
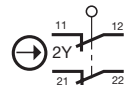
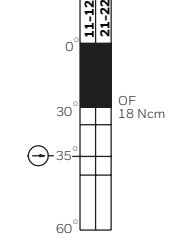
	Contacts	Contact Type	Contact Material	Operating Torque max. Ncm [in-lb]	Bar Chart <sup>1</sup>	0.5-14 NPT Conduit	20 mm Conduit
	1NC-1NO	Snap action 	silver	9.8 [0.87]		<b>GLLA01A2B</b>	<b>GLLC01A2B</b>
	1NC-1NO		gold-plated	9.8 [0.87]		<b>GLLA07A2B</b>	-
	1NC-1NO	BBM, slow action 	silver	10 [0.88]		<b>GLLA03A2B</b>	<b>GLLC03A2B</b>
	1NC-1NO	MBB, slow action 	silver	15.0 [1.33]		<b>GLLA04A2B</b>	<b>GLLC04A2B</b>
	2NC	Slow action 	silver	15.0 [1.33]		<b>GLLA06A2B</b>	<b>GLLC06A2B</b>

<sup>1</sup>Contact closed ■; Contact open □. \*Positive opening occurs.

# MICRO SWITCH Miniature Industrial Limit Switch, GLL Series

Table 6. Side Rotary, 31,5 mm Lever with Ø50 mm Rubber Roller

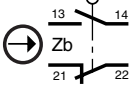
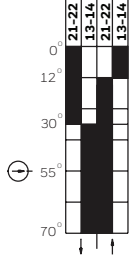
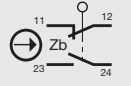
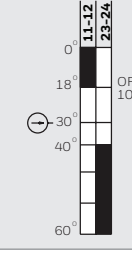
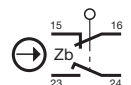
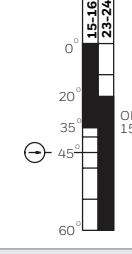
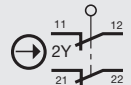
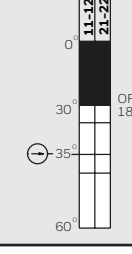
	Contacts	Contact Type	Contact Material	Operating Torque max. Ncm [in-lb]	Bar Chart <sup>1</sup>	0.5-14 NPT Conduit	20 mm Conduit
	1NC-1NO	Snap action 	silver	9,8 [0.87]		<b>GLLA01A1Y</b>	<b>GLLC01A1Y</b>
	1NC-1NO	BBM, slow action 	silver	10 [0.88]		<b>GLLA03A1Y</b>	<b>GLLC03A1Y</b>
	1NC-1NO	MBB, slow action 	silver	15 [1.33]		<b>GLLA04A1Y</b>	<b>GLLC04A1Y</b>
	2NC	Slow action 	silver	18 [1.59]		<b>GLLA06A1Y</b>	<b>GLLC06A1Y</b>

<sup>1</sup>Contact closed ■; Contact open □. \*Positive opening occurs.



# MICRO SWITCH Miniature Industrial Limit Switch, GLL Series

Table 7. Side Rotary, 31,5 mm to 75 mm Adjustable Lever with Ø50 mm Rubber Roller

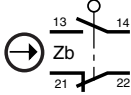
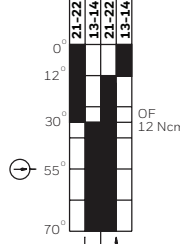
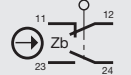
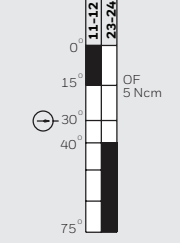
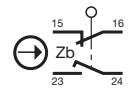
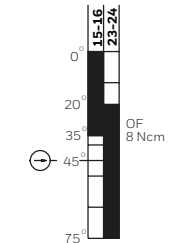
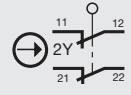
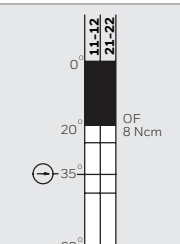
	Contacts	Contact Type	Contact Material	Operating Torque max. Ncm [in-lb]	Bar Chart <sup>1</sup>	0.5-14 NPT Conduit	20 mm Conduit
	1NC-1NO	Snap action 	silver	12 [1.06]		<b>GLLA01A2Y</b>	<b>GLLC01A2Y</b>
	1NC-1NO	BBM, slow action 	silver	5 [0.44]		<b>GLLA03A2Y</b>	<b>GLLC03A2Y</b>
	1NC-1NO	MBB, slow action 	silver	8 [0.71]		<b>GLLA04A2Y</b>	<b>GLLC04A2Y</b>
	2NC	Slow action 	silver	8 [0.71]		<b>GLLA06A2Y</b>	<b>GLLC06A2Y</b>

<sup>1</sup>Contact closed ■; Contact open □. \*Positive opening occurs.

# MICRO SWITCH Miniature Industrial Limit Switch, GLL Series

Table 8. Side Rotary, 22 mm to 150 mm with Ø3 mm Adjustable Metal Rod

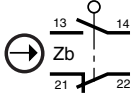
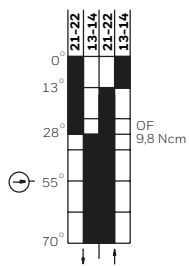
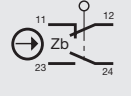
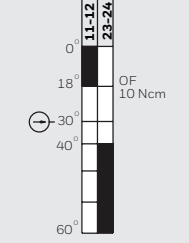
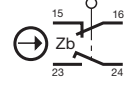
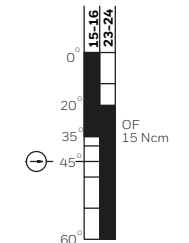
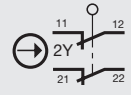
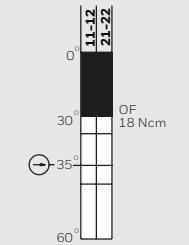
	Contacts	Contact Type	Contact Material	Operating Torque max. Ncm [in-lb]	Bar Chart <sup>1</sup>	0.5-14 NPT Conduit	20 mm Conduit
	1NC-1NO	Snap action 	silver	9,8 [0.87]		<b>GLLA01A4J</b>	<b>GLLC01A4J</b>
	1NC-1NO	BBM, slow action 	silver	10 [0.88]		<b>GLLA03A4J</b>	<b>GLLC03A4J</b>
	1NC-1NO	MBB, slow action 	silver	15 [1.33]		<b>GLLA04A4J</b>	<b>GLLC04A4J</b>
	2NC	Slow action 	silver	18 [1.59]		<b>GLLA06A4J</b>	<b>GLLC06A4J</b>

<sup>1</sup>Contact closed ■, Contact open □. \*Positive opening occurs.

# MICRO SWITCH Miniature Industrial Limit Switch, GLL Series

Table 9. Top Pin Plunger

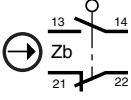
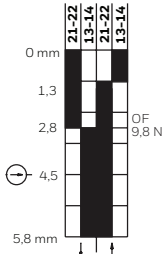
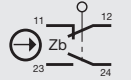
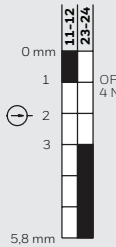
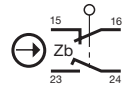
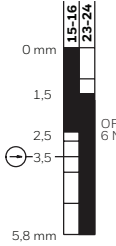
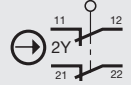
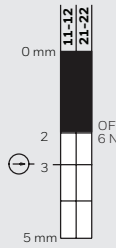
	Contacts	Contact Type	Contact Material	Operating Force max. N [lb]	Bar Chart <sup>1</sup>	0.5-14 NPT Conduit	20 mm Conduit
	1NC-1NO	Snap action 	silver	9,8 [2.22]		<b>GLLA01B</b>	<b>GLLC01B</b>
	1NC-1NO	BBM, slow action 	silver	4 [0.9]		<b>GLLA03B</b>	<b>GLLC03B</b>
	1NC-1NO	MBB, slow action 	silver	6 [1.35]		<b>GLLA04B</b>	<b>GLLC04B</b>
	2NC	Slow action 	silver	6 [1.35]		<b>GLLA06B</b>	<b>GLLC06B</b>

<sup>1</sup>Contact closed ■; Contact open □. \*Positive opening occurs.

# MICRO SWITCH Miniature Industrial Limit Switch, GLL Series

Table 10. Top Roller Plunger

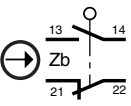
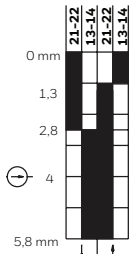
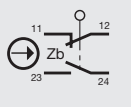
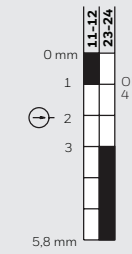
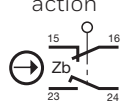
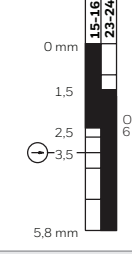
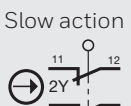
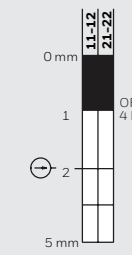
	Contacts	Contact Type	Contact Material	Operating Force max. N [lb]	Bar Chart <sup>1</sup>	0.5-14 NPT Conduit	20 mm Conduit
	1NC-1NO	Snap action 	silver	9,8 [2.22]		<b>GLLA01C</b>	<b>GLLA01C</b>
	1NC-1NO	BBM, slow action 	silver	4 [0.9]		<b>GLLA03C</b>	<b>GLLA03C</b>
	1NC-1NO	MBB, slow action 	silver	6 [1.35]		<b>GLLA04C</b>	<b>GLLC04C</b>
	2NC	Slow action 	silver	4 [0.9]		<b>GLLA06C</b>	<b>GLLC06C</b>

<sup>1</sup>Contact closed ■; Contact open □. \*Positive opening occurs.

# MICRO SWITCH Miniature Industrial Limit Switch, GLL Series

Table 11. Top Horizontal Roller Lever

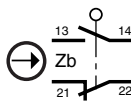
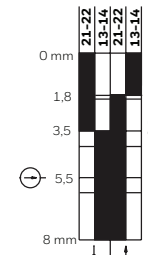
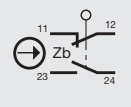
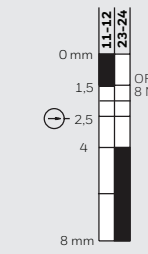
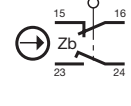
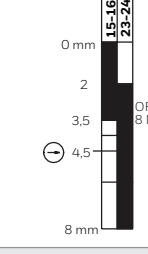
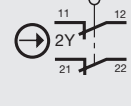
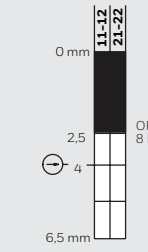
	Contacts	Contact Type	Contact Material	Operating Force max. N [lb]	Bar Chart <sup>1</sup>	0.5-14 NPT Conduit	20 mm Conduit
	1NC-1NO	Snap action 	silver	9,8 [2.22]		<b>GLLA01D</b>	<b>GLLC01D</b>
	1NC-1NO	BBM, slow action 	silver	8 [1.8]		<b>GLLA03D</b>	<b>GLLC03D</b>
	1NC-1NO	MBB, slow action 	silver	8 [1.8]		<b>GLLA04D</b>	<b>GLLC04D</b>
	2NC	Slow action 	silver	8 [1.8]		<b>GLLA06D</b>	<b>GLLC06D</b>

<sup>1</sup>Contact closed ■; Contact open □. \*Positive opening occurs.

# MICRO SWITCH Miniature Industrial Limit Switch, GLL Series

Table 12. Top Vertical Roller Lever

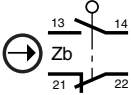
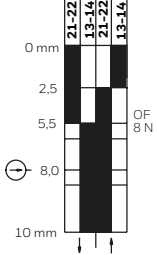
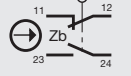
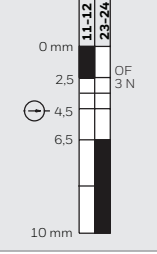
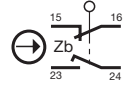
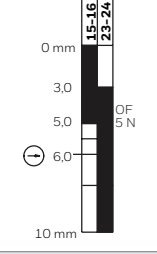
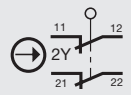
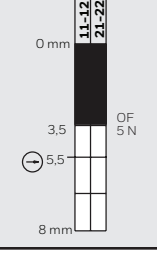
	Contacts	Contact Type	Contact Material	Operating Force max. N [lb]	Bar Chart <sup>1</sup>	0.5-14 NPT Conduit	20 mm Conduit
	1NC-1NO	Snap action 	silver	8 [1.8]		<b>GLLA01F</b>	<b>GLLC01F</b>
	1NC-1NO	BBM, slow action 	silver	3 [0.67]		<b>GLLA03F</b>	<b>GLLC03F</b>
	1NC-1NO	MBB, slow action 	silver	5 [1.12]		<b>GLLA04F</b>	<b>GLLC04F</b>
	2NC	Slow action 	silver	5 [1.12]		<b>GLLA06F</b>	<b>GLLC06F</b>

<sup>1</sup>Contact closed ■; Contact open □. \*Positive opening occurs.

# MICRO SWITCH Miniature Industrial Limit Switch, GLL Series

Figure 2. GLL Side Rotary (A1B) with Fixed Lever Dimensions      Figure 3. GLL Side Rotary (A3B) with Fixed Lever Dimensions

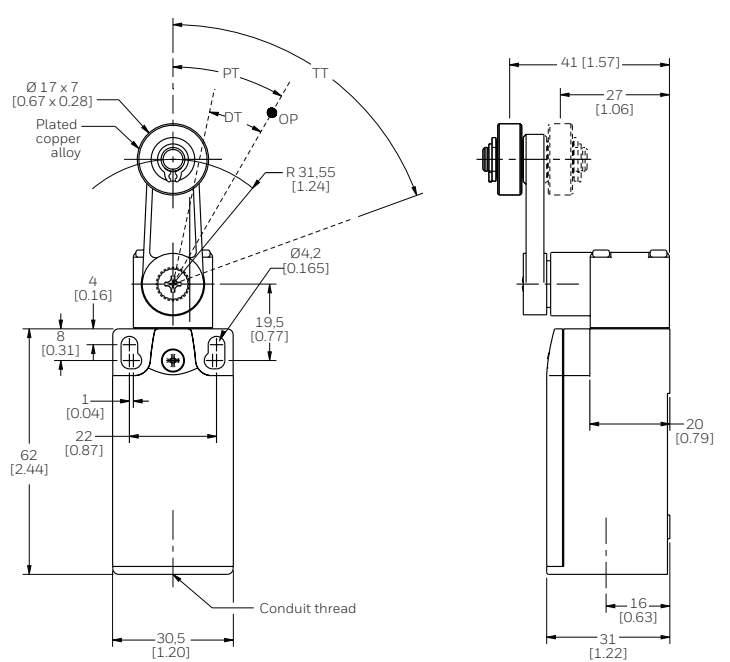
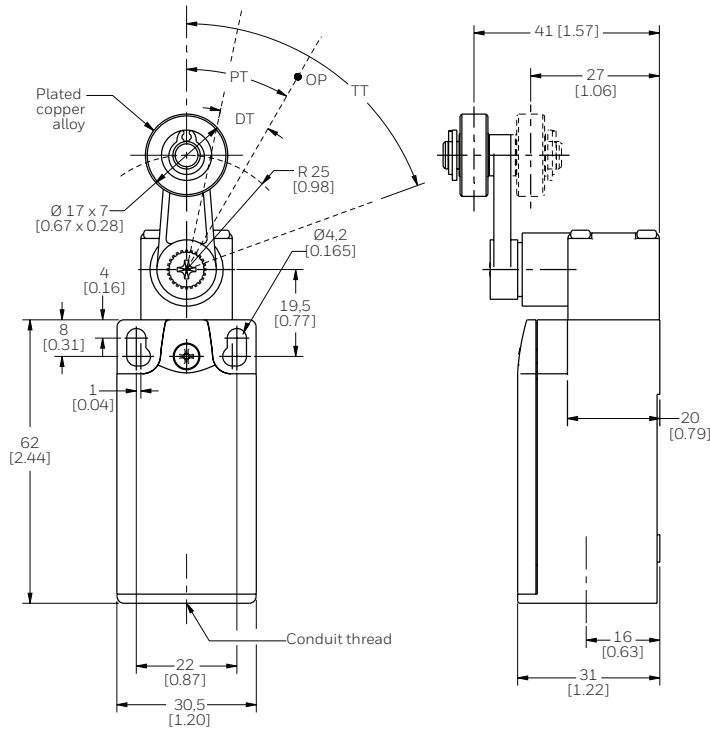

Figure 4. GLL Side Rotary (A2B) with Adj. Lever Dimensions

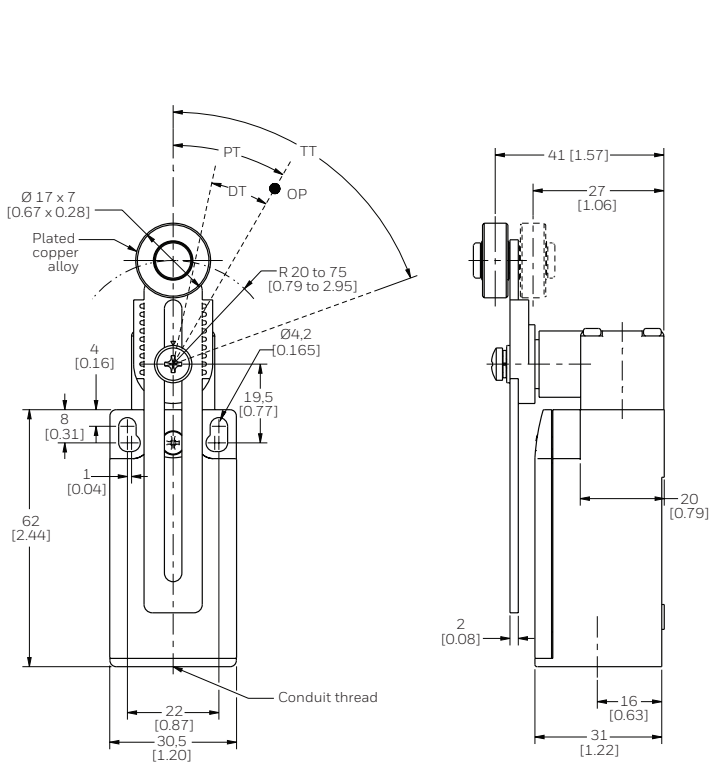
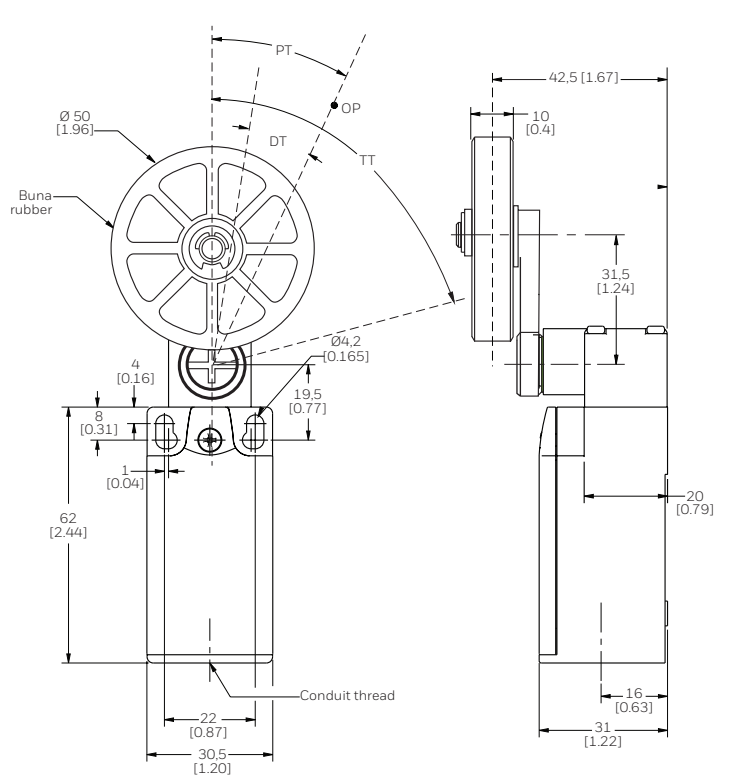
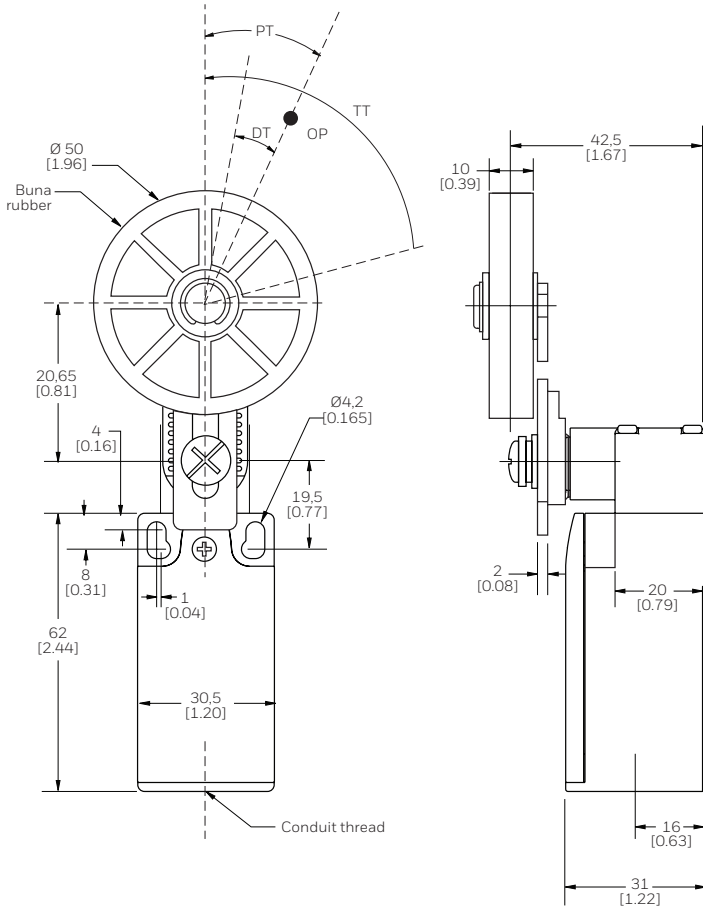

Figure 5. GLL Side Rotary (A1Y) with Roller Lever Dimensions



# MICRO SWITCH Miniature Industrial Limit Switch, GLL Series

**Figure 6. GLL Side Rotary (A2Y) with Adj. Roller Lever Dimensions**



**Figure 7. GLL Side Rotary (A4J) with Adj. Rod Lever Dimensions**

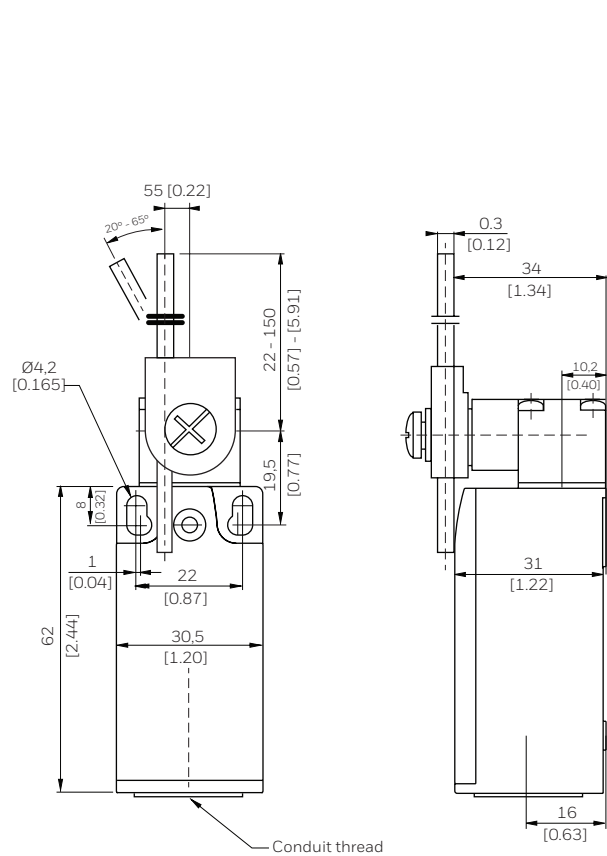

**Figure 8. GLL Top Pin Plunger Dimensions**

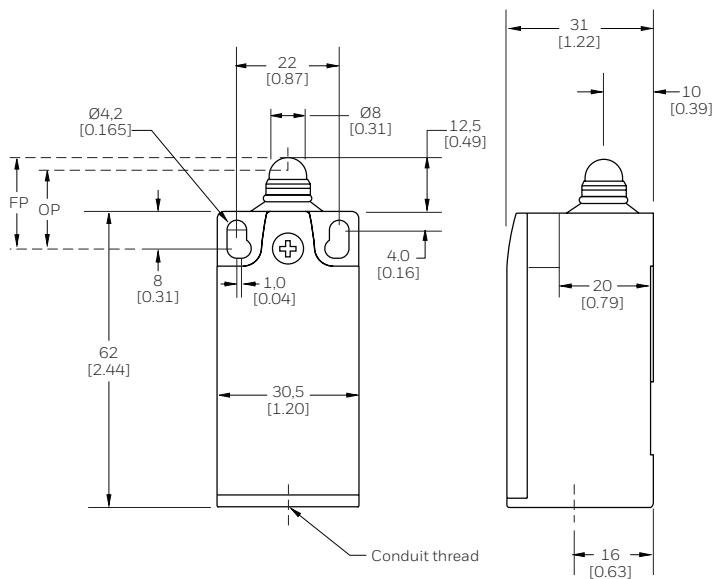

**Figure 8. GLL Top Roller Plunger Dimensions**

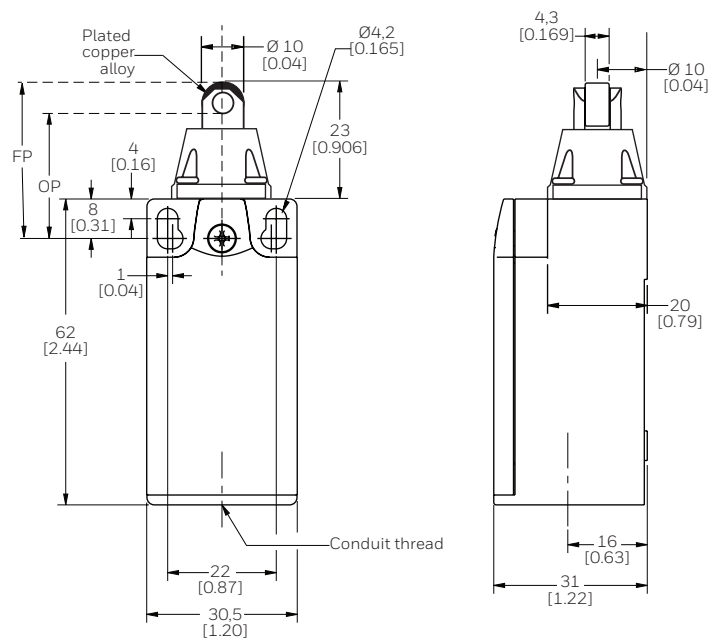



# MICRO SWITCH Miniature Industrial Limit Switch, GLL Series

Figure 10. GLL Top Horizontal Roller Lever Dimensions

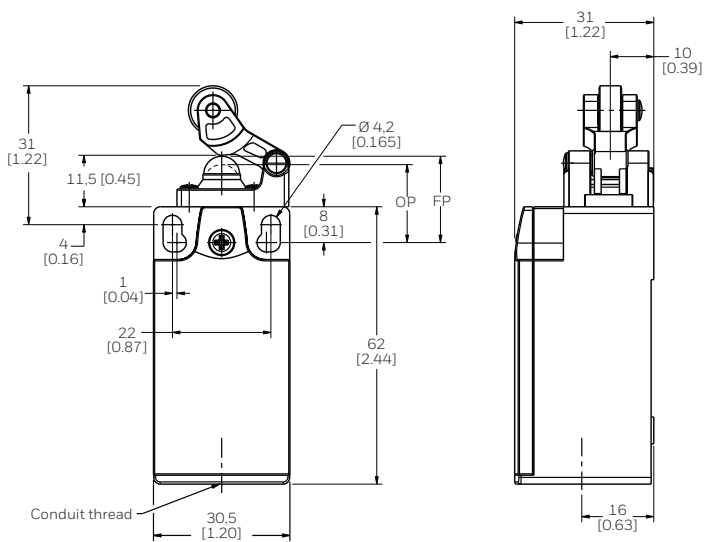
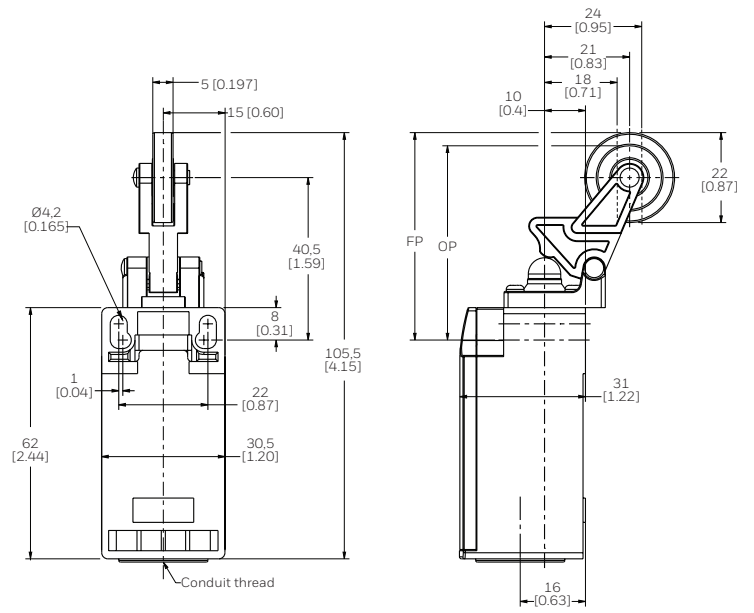

Figure 11. GLL Top Vertical Roller Lever Dimensions



## ADDITIONAL MATERIALS

The following associated literature is available on the Honeywell web site at [sensing.honeywell.com](http://sensing.honeywell.com):

- Product installation instructions
- Product range guide

### Find out more

Honeywell serves its customers through a worldwide network of sales offices, representatives and distributors. For application assistance, current specifications, pricing or name of the nearest Authorized Distributor, contact your local sales office. To learn more about Honeywell's sensing and control products, call **+1.815.235.6847** or **1.800.537.6945**, visit **[sensing.honeywell.com](http://sensing.honeywell.com)**, or e-mail inquiries to **[info.sc@honeywell.com](mailto:info.sc@honeywell.com)**

### Honeywell Sensing and Internet of Things

9680 Old Bailes Road  
Fort Mill, SC 29707  
[www.honeywell.com](http://www.honeywell.com)

## **WARNING** **PERSONAL INJURY**

DO NOT USE these products as safety or emergency stop devices or in any other application where failure of the product could result in personal injury.

**Failure to comply with these instructions could result in death or serious injury.**

## **WARNING** **MISUSE OF DOCUMENTATION**

- The information presented in this product sheet is for reference only. Do not use this document as a product installation guide.
- Complete installation, operation, and maintenance information is provided in the instructions supplied with each product.

**Failure to comply with these instructions could result in death or serious injury.**

### Warranty/Remedy

Honeywell warrants goods of its manufacture as being free of defective materials and faulty workmanship during the applicable warranty period. Honeywell's standard product warranty applies unless agreed to otherwise by Honeywell in writing; please refer to your order acknowledgment or consult your local sales office for specific warranty details. If warranted goods are returned to Honeywell during the period of coverage, Honeywell will repair or replace, at its option, without charge those items that Honeywell, in its sole discretion, finds defective. **The foregoing is buyer's sole remedy and is in lieu of all other warranties, expressed or implied, including those of merchantability and fitness for a particular purpose. In no event shall Honeywell be liable for consequential, special, or indirect damages.**

While Honeywell may provide application assistance personally, through our literature and the Honeywell web site, it is buyer's sole responsibility to determine the suitability of the product in the application.

Specifications may change without notice. The information we supply is believed to be accurate and reliable as of this writing. However, Honeywell assumes no responsibility for its use.

# Honeywell