

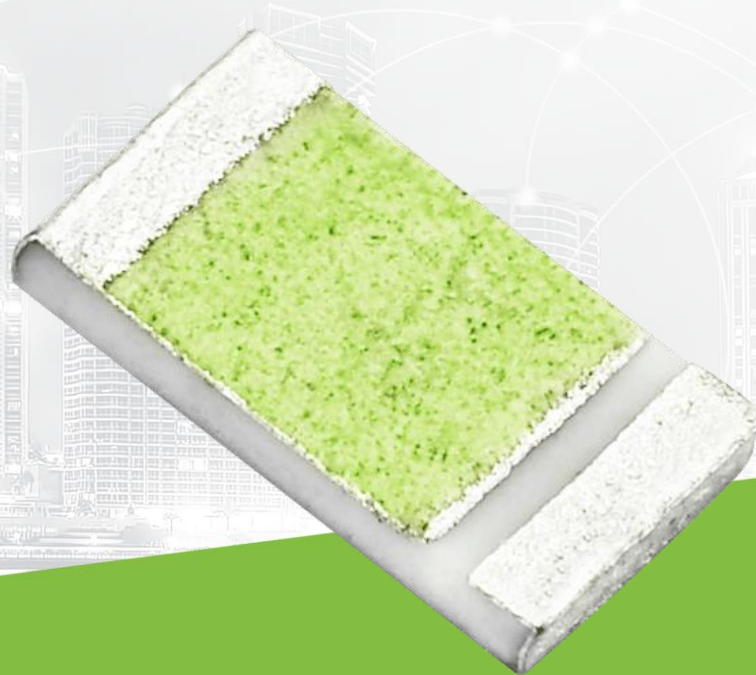

TAOGLAS®



Datasheet

Unifier GPS/GLONASS/Galileo/BeiDou Ceramic SMD Antenna

Part No:
GGBLA.01.A

Features:

Covering:

- GPS L1/Galileo E1
- BeiDou B1
- GLONASS G1

Dimensions: 3.2mm x 1.6mm x 0.5mm

Low profile Ceramic Loop antenna

Omnidirectional

CE Certified

RoHS and REACH Compliant

1. Introduction	3
2. Specifications	4
3. Antenna Characteristics	6
4. Radiation Patterns	9
5. Mechanical Drawing	13
6. Antenna Integration Guide	15
7. Packaging	23
<hr/>	
Changelog	24

Taoglas makes no warranties based on the accuracy or completeness of the contents of this document and reserves the right to make changes to specifications and product descriptions at any time without notice. Taoglas reserves all rights to this document and the information contained herein. Reproduction, use or disclosure to third parties without express permission is strictly prohibited.



1. Introduction

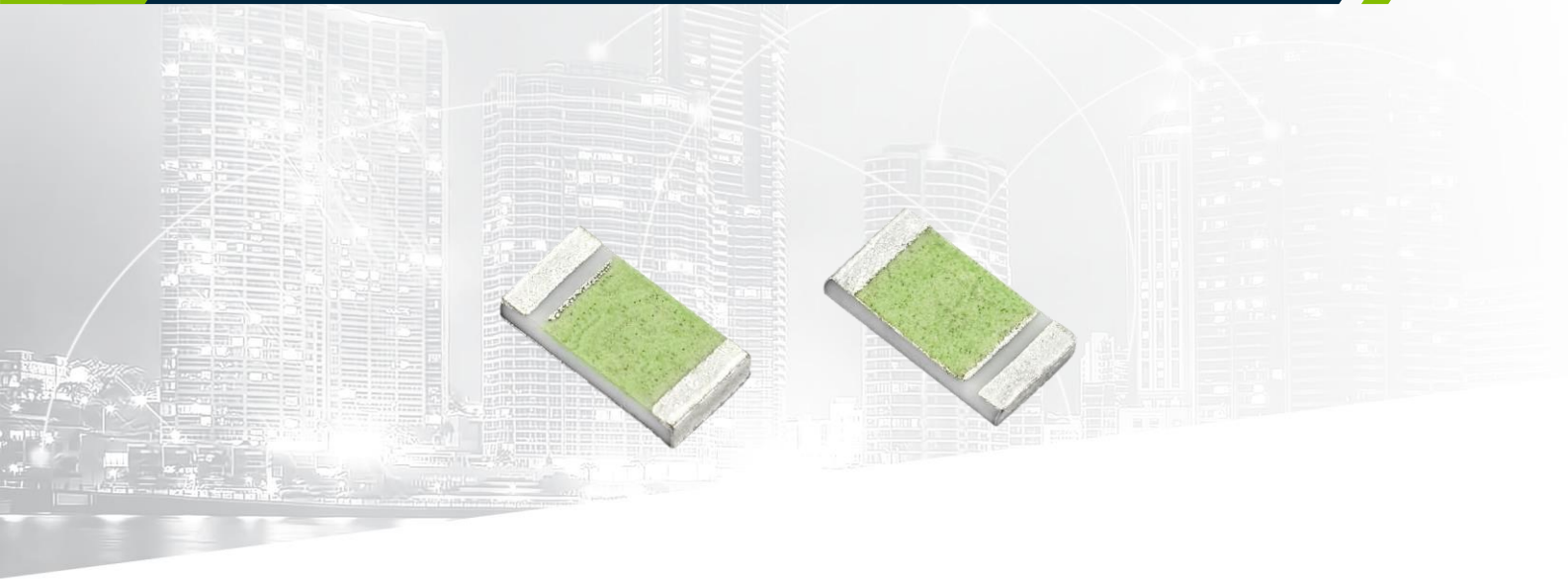

Taoglas have developed a unique ceramic miniature loop antenna series for GPS-GLONASS-Galileo-BeiDou applications. At 3.2*1.6*0.5mm, the Unifier GGBLA.01.A Loop antenna is a miniature edge mounted SMD antenna, designed for small space requirements. Typical applications are small sized automotive navigation or position tracking systems and hand-held devices when GNSS function is needed.

The radiation pattern is more omnidirectional than traditional patch antennas. The Unifier antenna series wide bandwidth allows high efficiency, stable reception on all three GPS, GLONASS and BeiDou bands from 1555MHz to 1602MHz.

Efficiencies of 64% to 85% are achievable. Peak gain of 3.3dBi places this antenna gain performance within the range of a much larger 15mm to 18mm patch antennas.

Based on the loop effect this antenna works best when placed on the center of the edge of the board, but can still work better than traditional linear polarized chip antennas even when placed at corners as substitute.

The Unifier GGBLA.01.A is delivered on tape and reel and now allows M2M customers to use an omnidirectional antenna in devices where orientation of the product is unknown. Like all small antennas, care must be taken to ensure the device ground-plane layout and antenna matching has been done correctly, Taoglas offers professional Gerber review, transmission line design, general integration support and final matching service of the GGBLA.01.A on your device board at our regional labs worldwide.

This antenna can be mounted with no performance degradation in either orientation as long as the antenna is soldered correctly via Surface mounting. Please see the integration instructions section for further detail regarding the optimum way to integrate this antenna into your device.

For further optimization to customer-specific device environments and for support to integrate and test this antennas performance in your device, contact your regional Taoglas Customer Services Team.

2. Specifications

GNSS Frequency Bands Covered							
GPS/QZSS	L1 1575.42MHz	L2 1227.6MHz	L5 1176.45MHz	L6 1278.75MHz			
	■	□	□	□			
GLONASS	L5R 1176.45MHz	L3PT 1201.5MHz	L2PT 1246MHz	L1CR 1575.42MHz	L1PT 1602MHz		
	□	□	□	■	■		
Galileo	E5a 1176.45MHz	E5b 1201.5MHz	E4 1215MHz	E3 1256MHz	E6 1278.75MHz	E2 1561MHz	L1 1575.42MHz
	□	□	□	□	□	■	■
BeiDou	B1 1561MHz	B2 1207.14MHz	B3 1268.52MHz				
	■	□	□				
Compass	E5B(B2)/ E6(B3) 1268.56MHz	E2(B1) 1561MHz					
	□	■					
SBAS	Omnistar 1542.5MHz	WAAS/EGN OS 1575.42MHz					
	□	■					

GNSS Electrical			
Frequency (MHz)	1561	1575.42	1602
VSWR (max.)	2.0:1 max	2.0:1 max	2.0:1 max
Efficiency (dB)	-1.29	-0.79	-1.65
Efficiency (%)	74.32	83.43	71.98
Gain (dBi)	2.90	3.29	2.58
Polarization	Linear		
Impedance	50 Ω		

Mechanical	
Dimensions	3.2mm x 1.6mm x 0.5 mm
Material	Ceramic
Environmental	
Operation Temperature	-40°C to 85°C
Storage Temperature	-40°C to 85°C
Humidity	20% to 70%
Moisture Senseitivity Level (MSL)	3 (168 Hours)

*Measured on a 80mm x 40mm Ground Plane

3. Antenna Characteristics

3.1 Return Loss

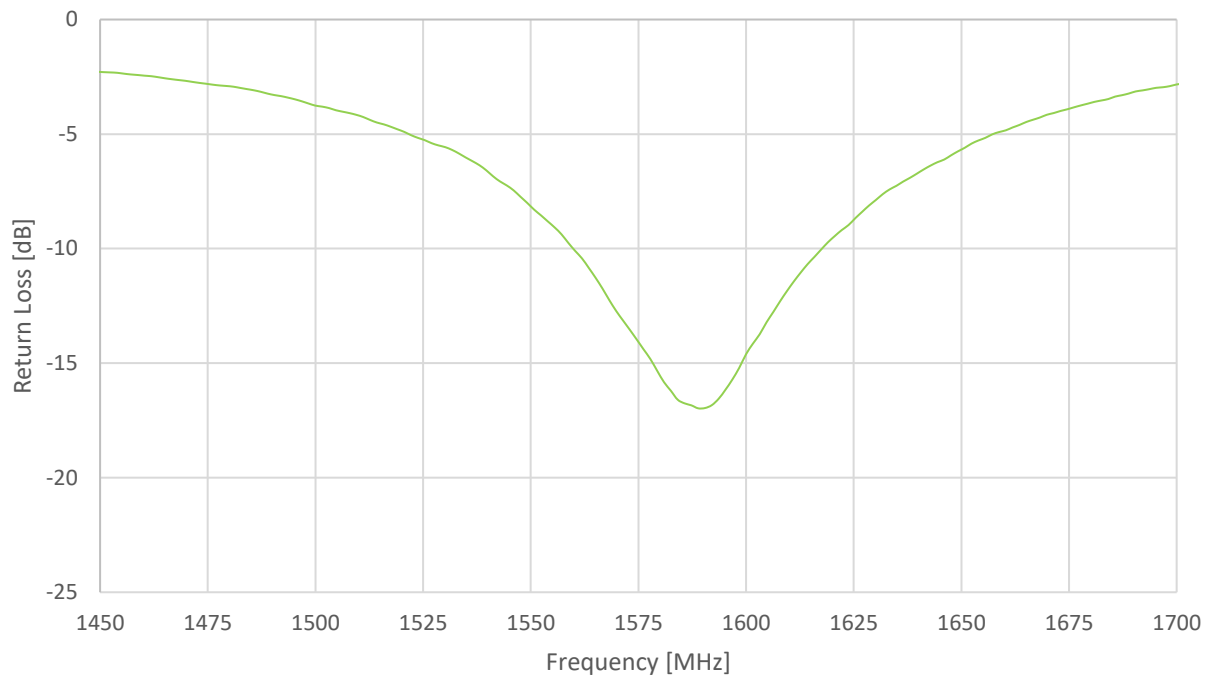

3.2 VSWR

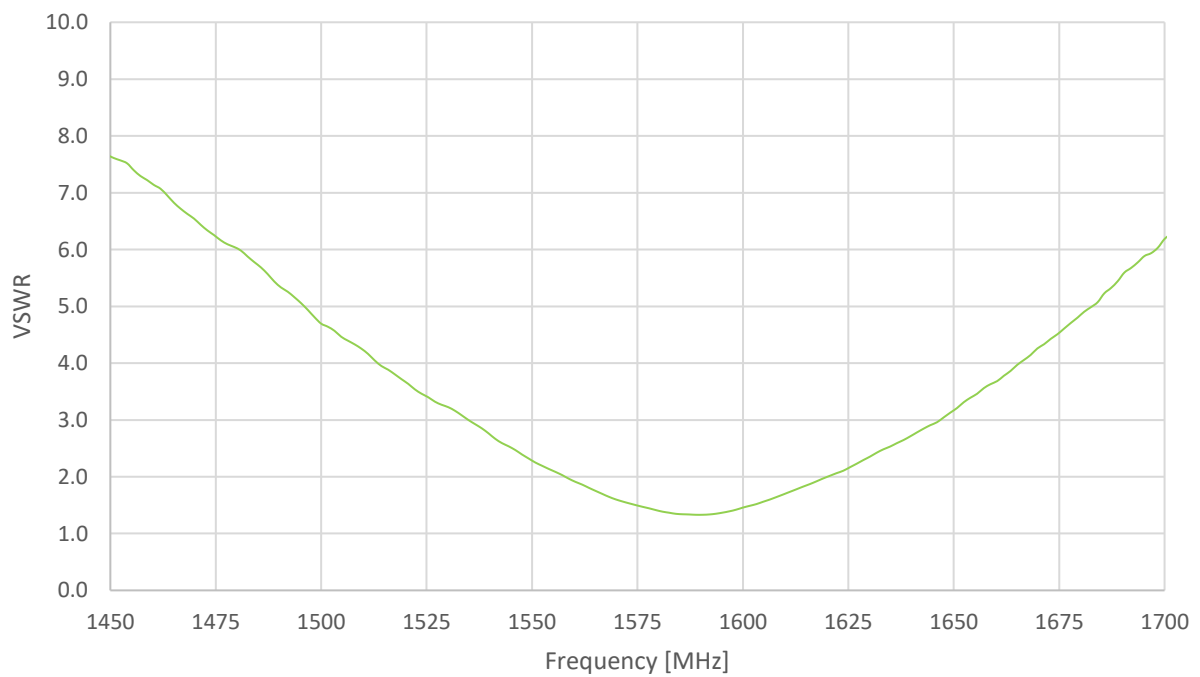

3.3 Efficiency

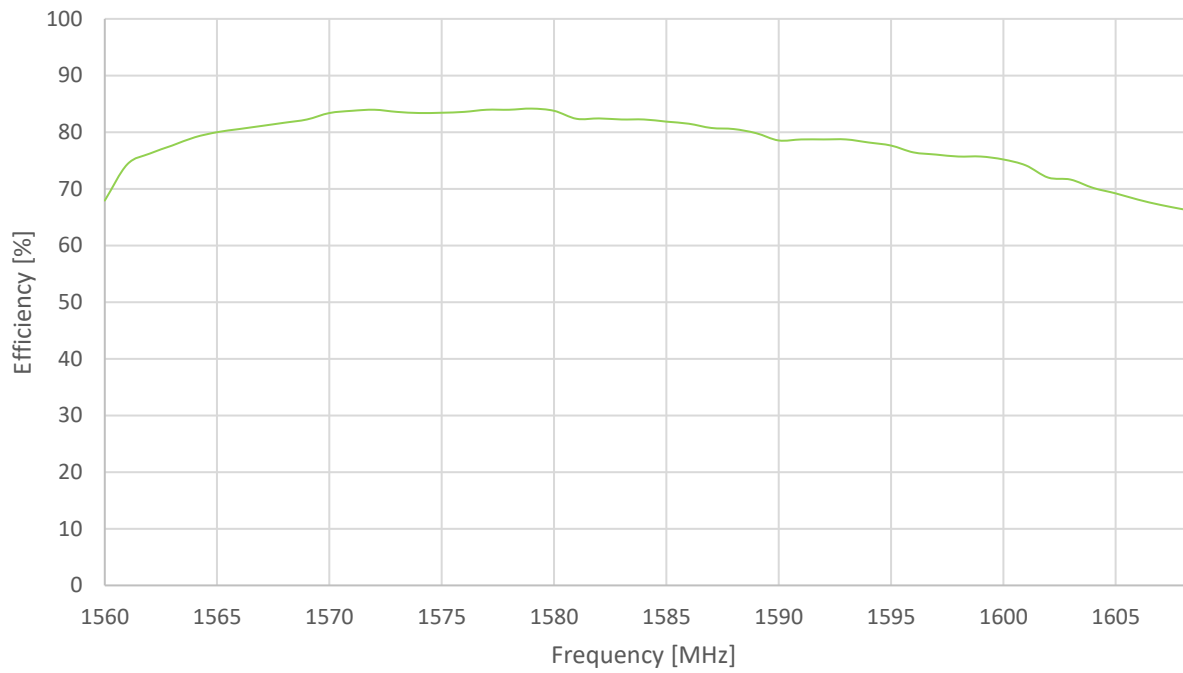

3.4 Peak Gain

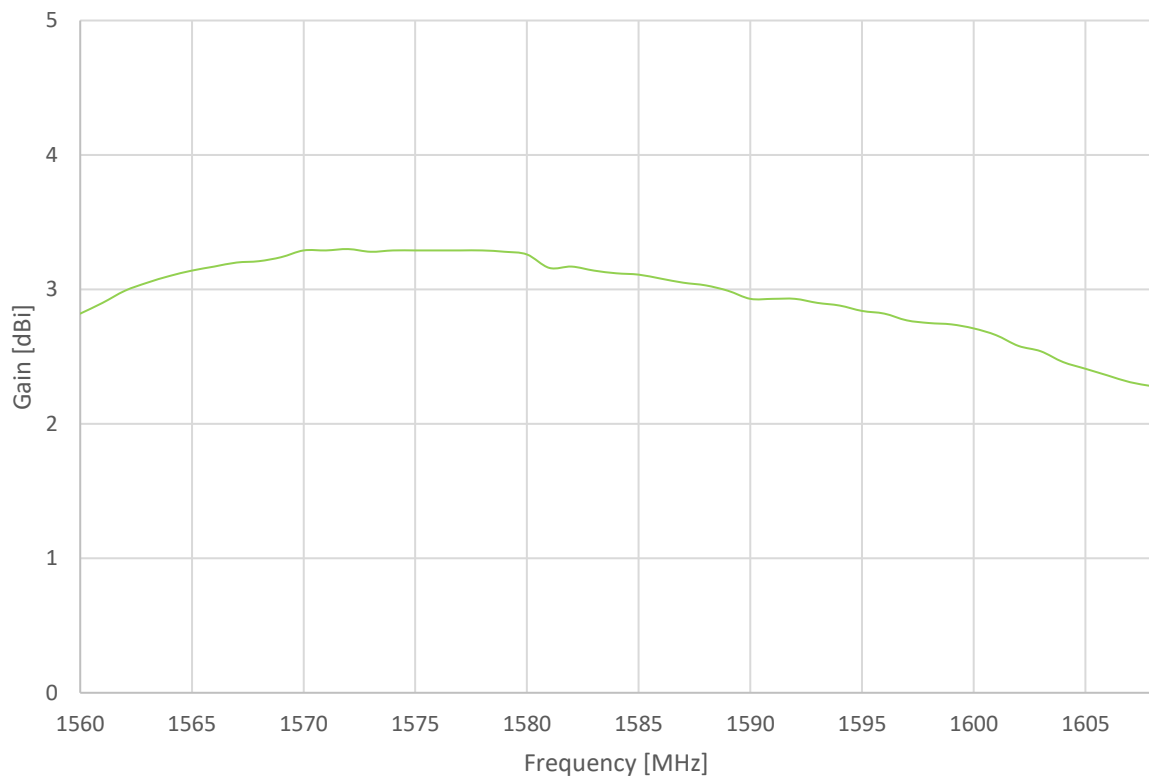

3.5 Average Gain

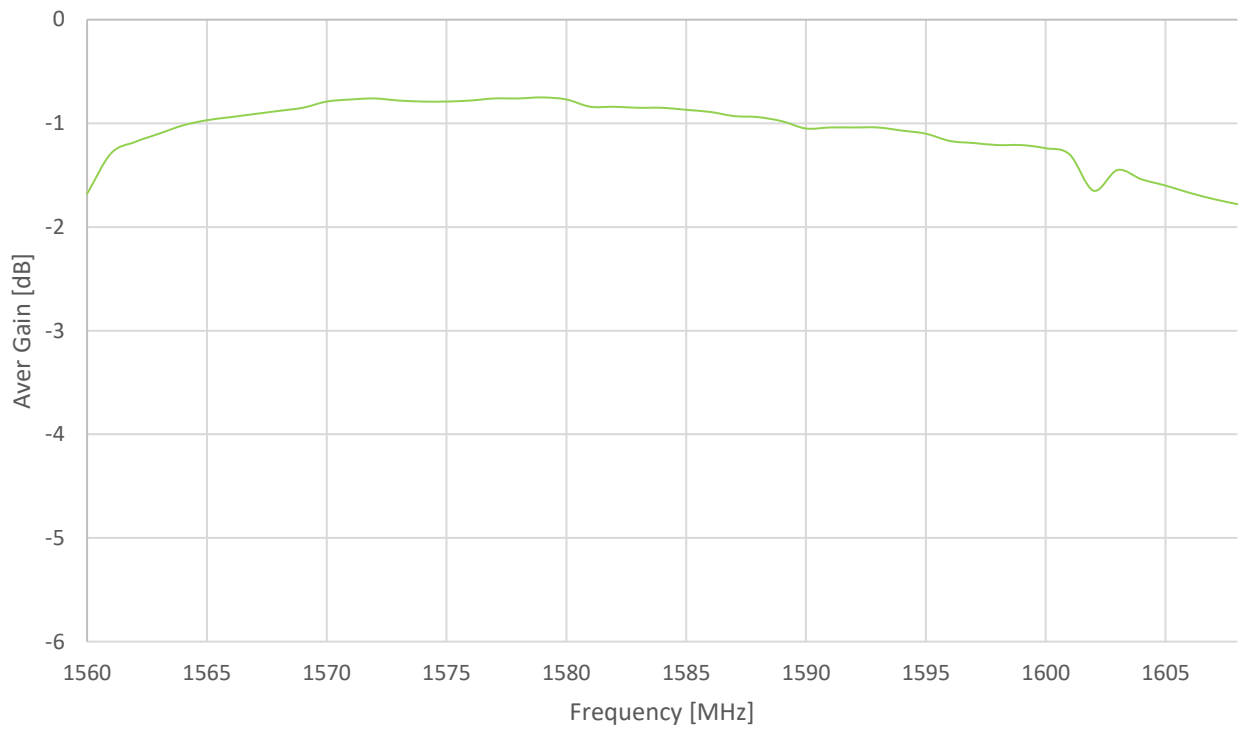

4. Radiation Patterns

4.1 Test Setup

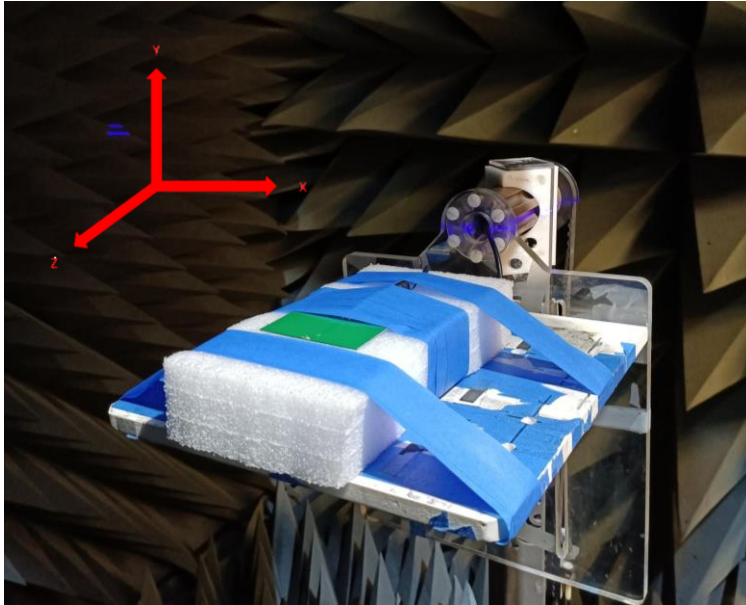

Chamber Set-up

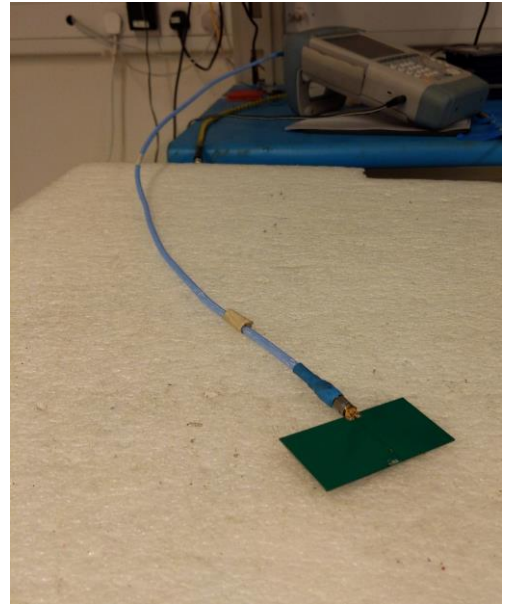

VNA Set-up

4.2 1560MHz 3D and 2D Radiation Patterns

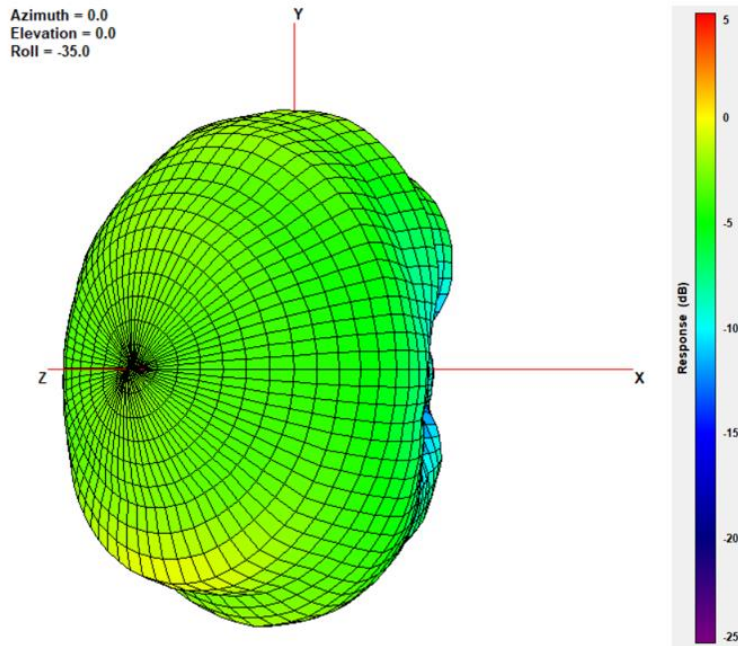

XY Plane

XZ Plane

YZ Plane

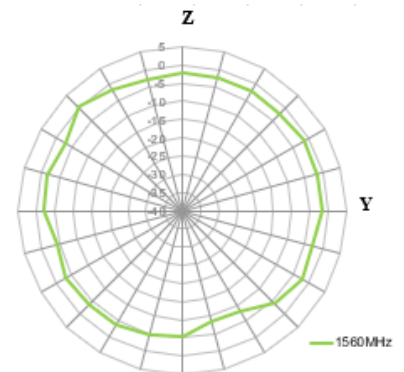
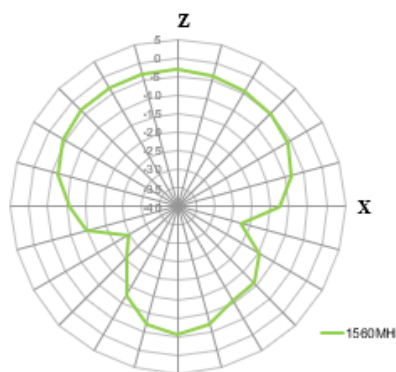
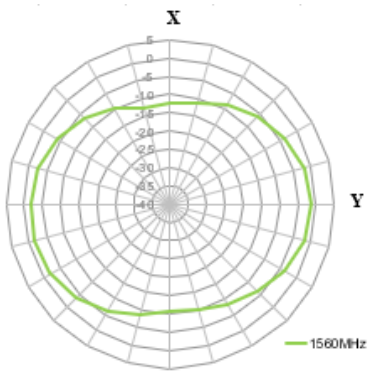

1575MHz

Azimuth = 0.0
Elevation = 0.0
Roll = -35.0

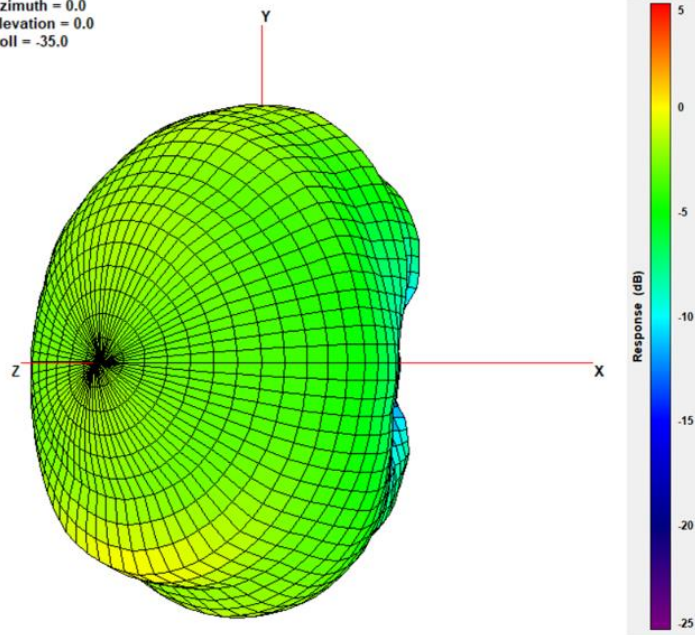

XY Plane

XZ Plane

YZ Plane

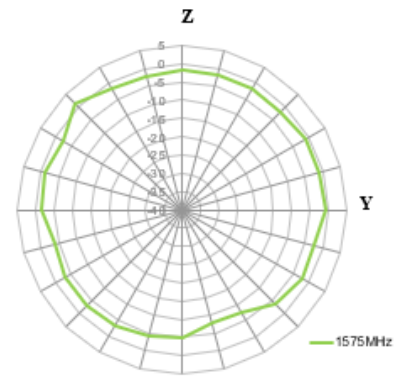
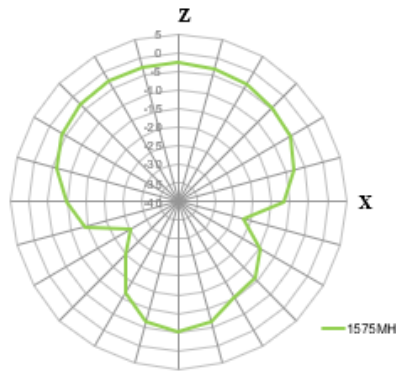
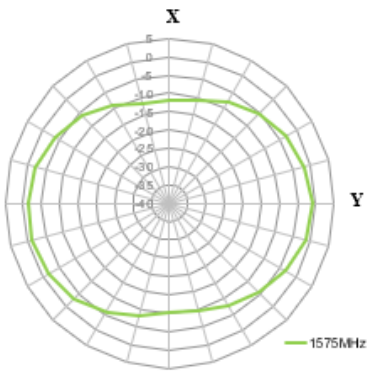

1602MHz

Azimuth = 0.0
Elevation = 0.0
Roll = -35.0

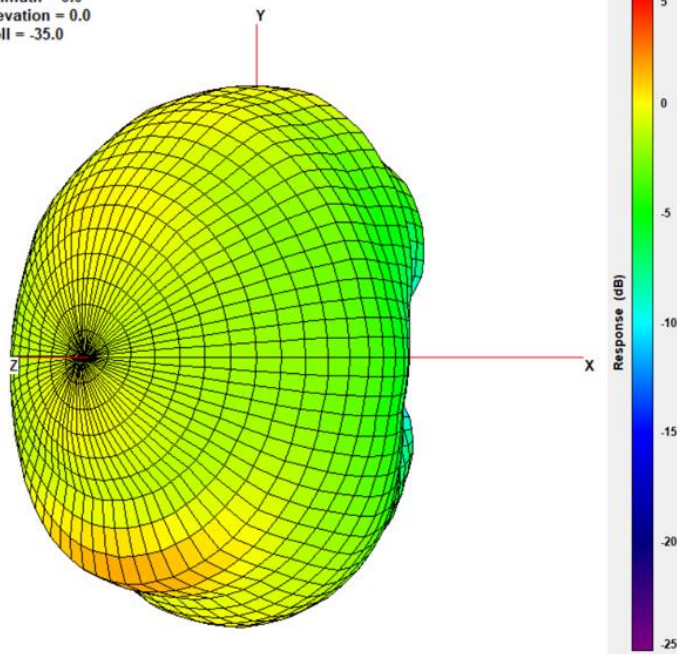

XY Plane

XZ Plane

YZ Plane

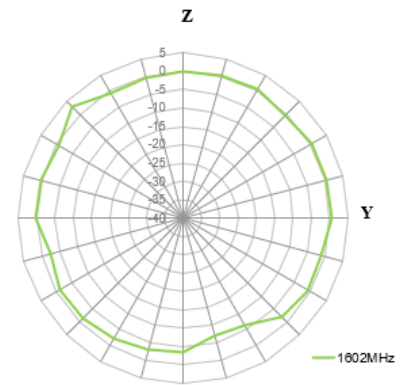
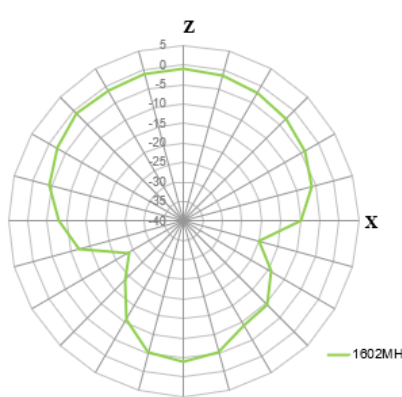
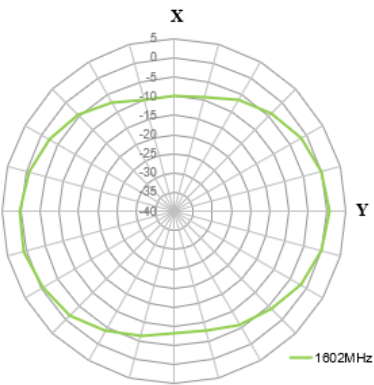

5. Mechanical Drawing (Units: mm)

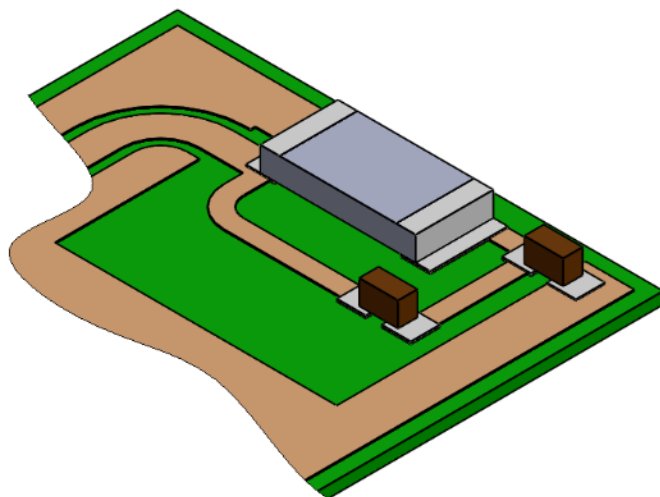
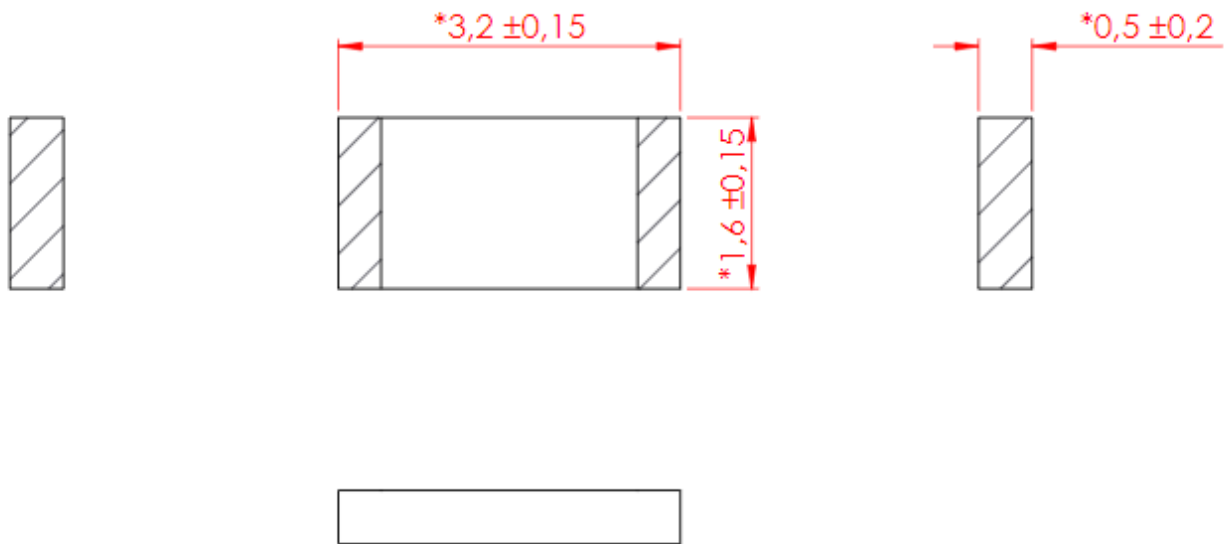

ANTENNA ON FOOTPRINT PCB VIEW

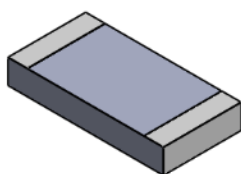

ANTENNA VIEW

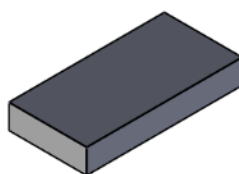

ANTENNA VIEW

6. Antenna Integration Guide

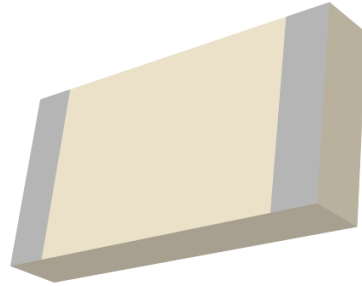

6.1 Schematic Symbol and Pin Definition

The circuit symbol for the antenna is shown below. The antenna has 3 pins with only two pins (Pin 1 and 2) as functional. Pin 3 is for FTE.

Pin	Description
1	RF Feed
2	Ground
3	FTE

ANT1 GGBLA.01.A

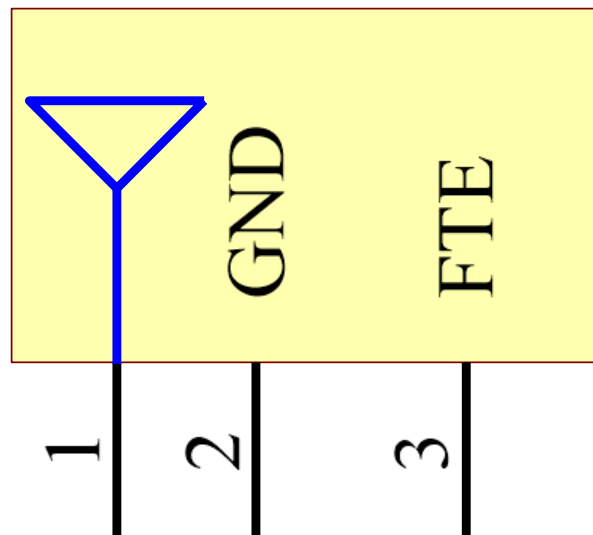

6.2 Antenna Integration

Whatever the size of the PCB, the antenna should ideally be placed on the PCB's longest side, to take advantage of the ground plane. Optimized matching components can be placed as shown.

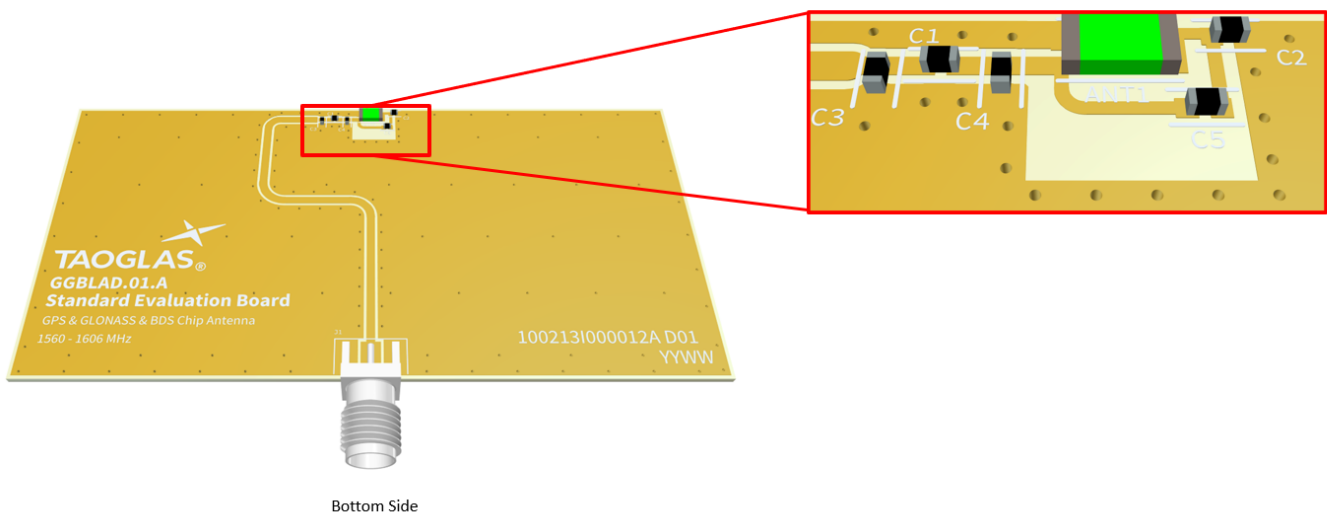
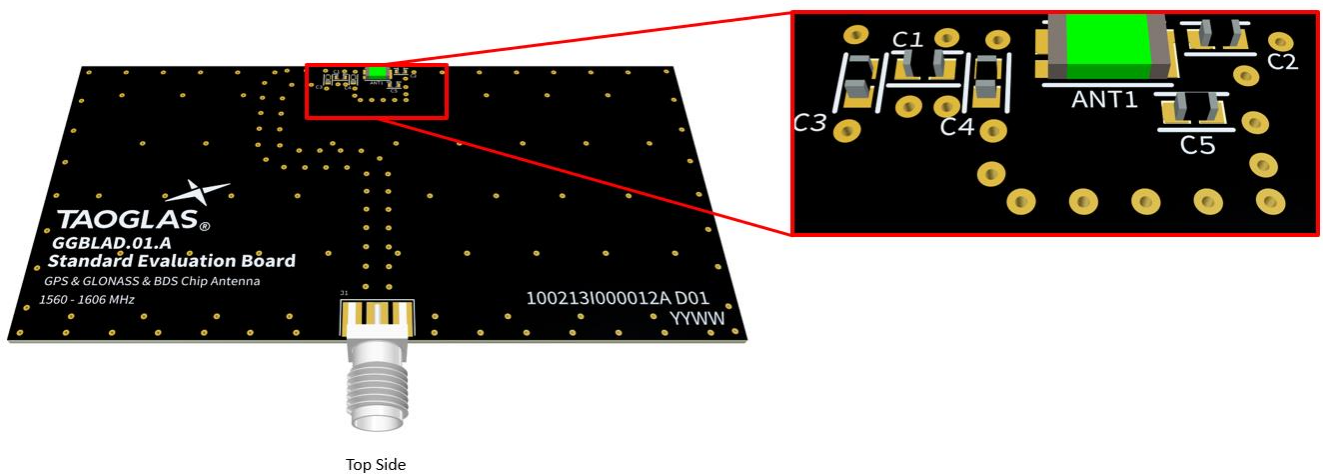

6.3 PCB Layout

The footprint and clearance on the PCB must meet the antenna specification. An example of the PCB layout shows the antenna footprint with clearance. Note the placement of the optimized components. C1 is positioned outside the ground plane, C2 is sitting across the ground plane and the copper clearance area and C5 sits within the copper clearance area.

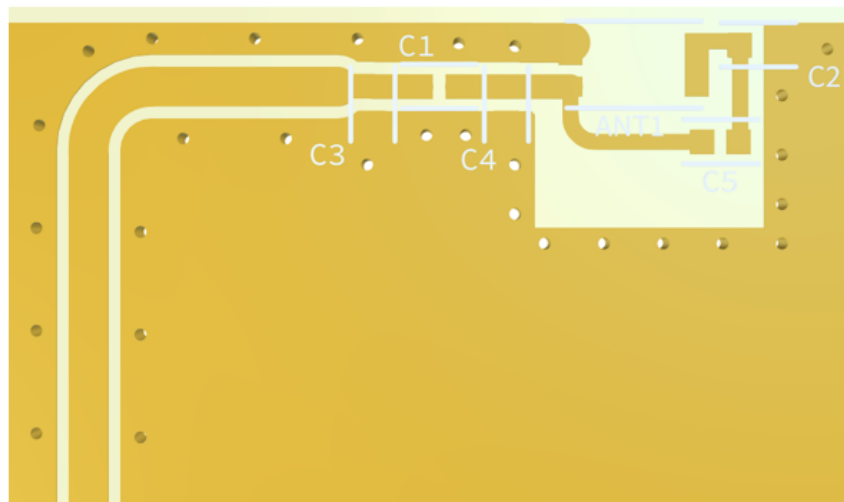

Top side



Bottom Side

6.4 PCB Keep Out

Below shows the antenna footprint and clearance through ALL layers on the PCB. Only the antenna pads and connections to feed and GND are present within this clearance area (marked RED). The clearance area extends to 5mm in length and 5.5mm in width from the antenna mechanical pads to the ground area. This clearance area includes the bottom side and ALL internal layers on the PCB.

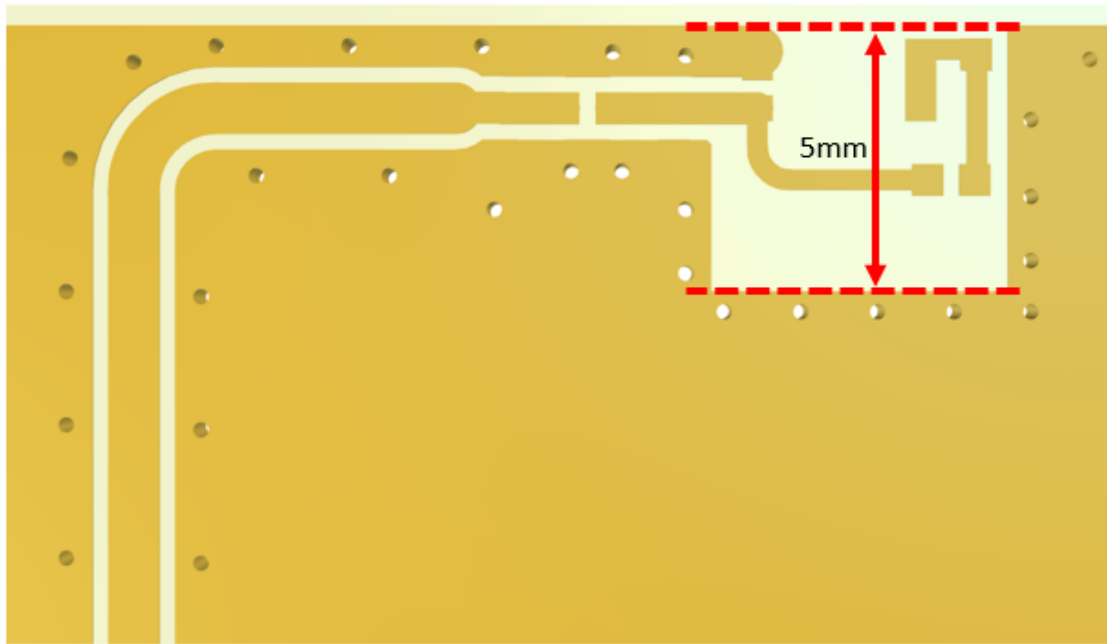

Topside

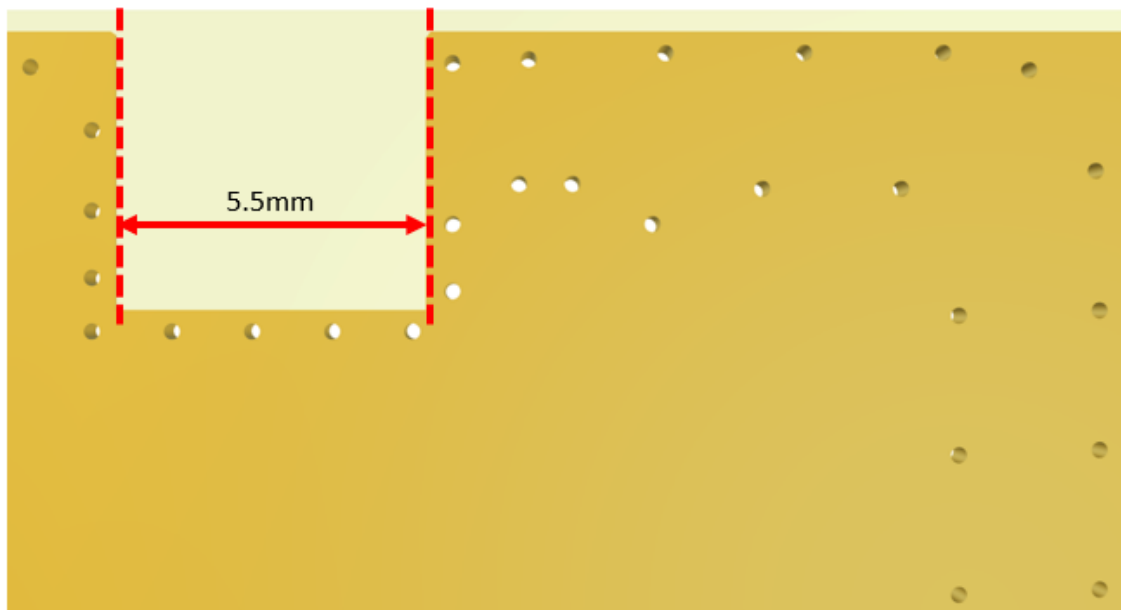

Bottom Side

6.5 Evaluation Board

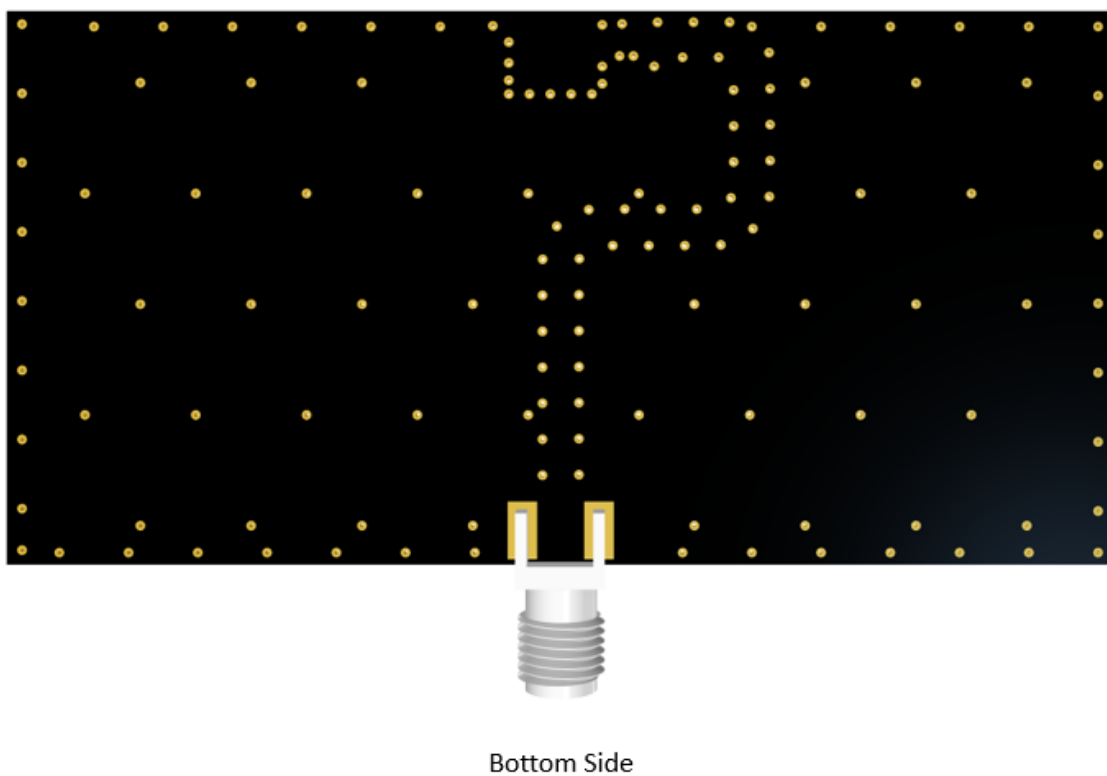
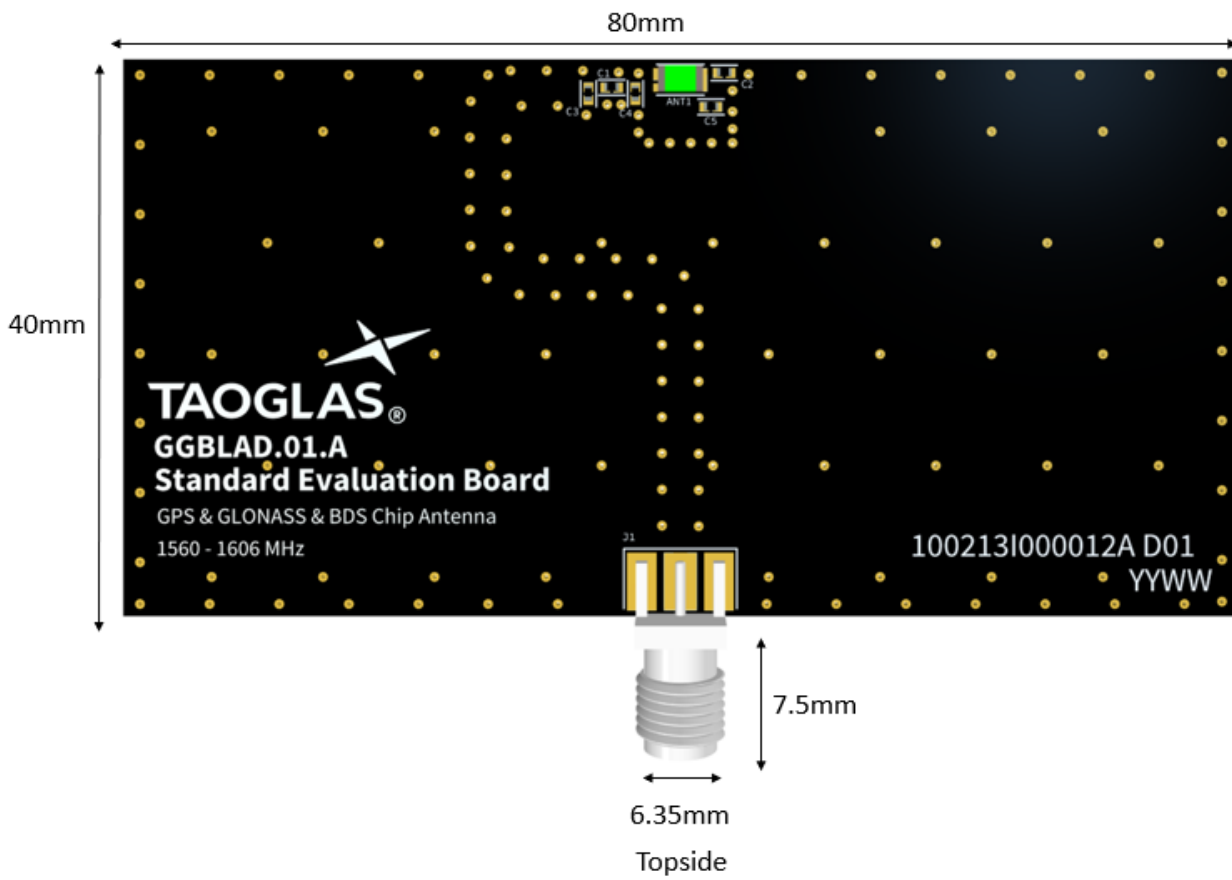

6.6 Evaluation Board Matching Circuit

Matching components C1, C3 and C4 form a “pi” network. Like all antennas, surrounding components, enclosures, and changes to the GND plane dimensions can alter performance. A pi-matching network like the one shown below is required in case adjustments need to be made. The antenna EVB has the same matching network. The components on the EVB are a good starting point for a new design but will need to be adjusted upon integration for best performance. The zero-ohm resistor is needed for the ability to solder down a coax pigtail to make measurements with a vector network analyzer.

Designator	Type	Value	Manufacturer	*Manufacturer Part Number
C1	Capacitor	2.7pF	Murata	GRM1555C1H2R7CA01D
C2	Capacitor	22pF	Murata	GRM1555C1H220JA01D
C3	Capacitor	Not Fitted	-	-
C4	Capacitor	0.8pF	Murata	GRM1555C1HR80CA01D
C5	Capacitor	0.5pF	Murata	GRM1555C1HR50CA01D

*Manufacturers part number above or latest version.

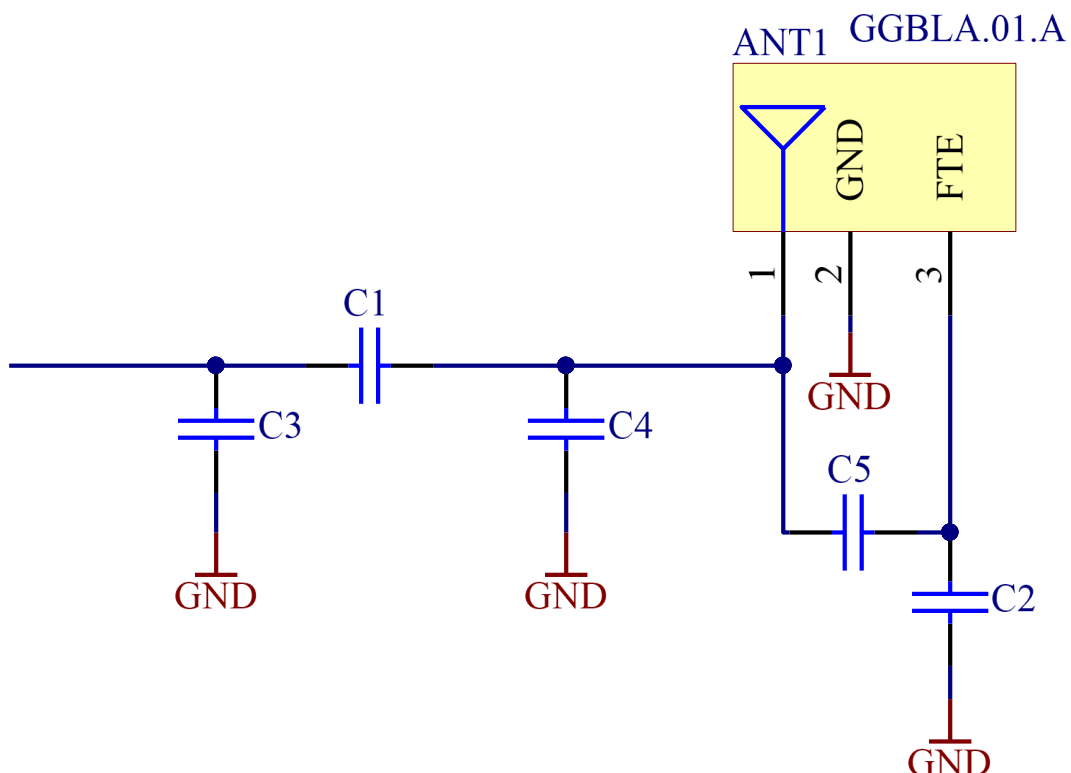

6.7 Footprint Information

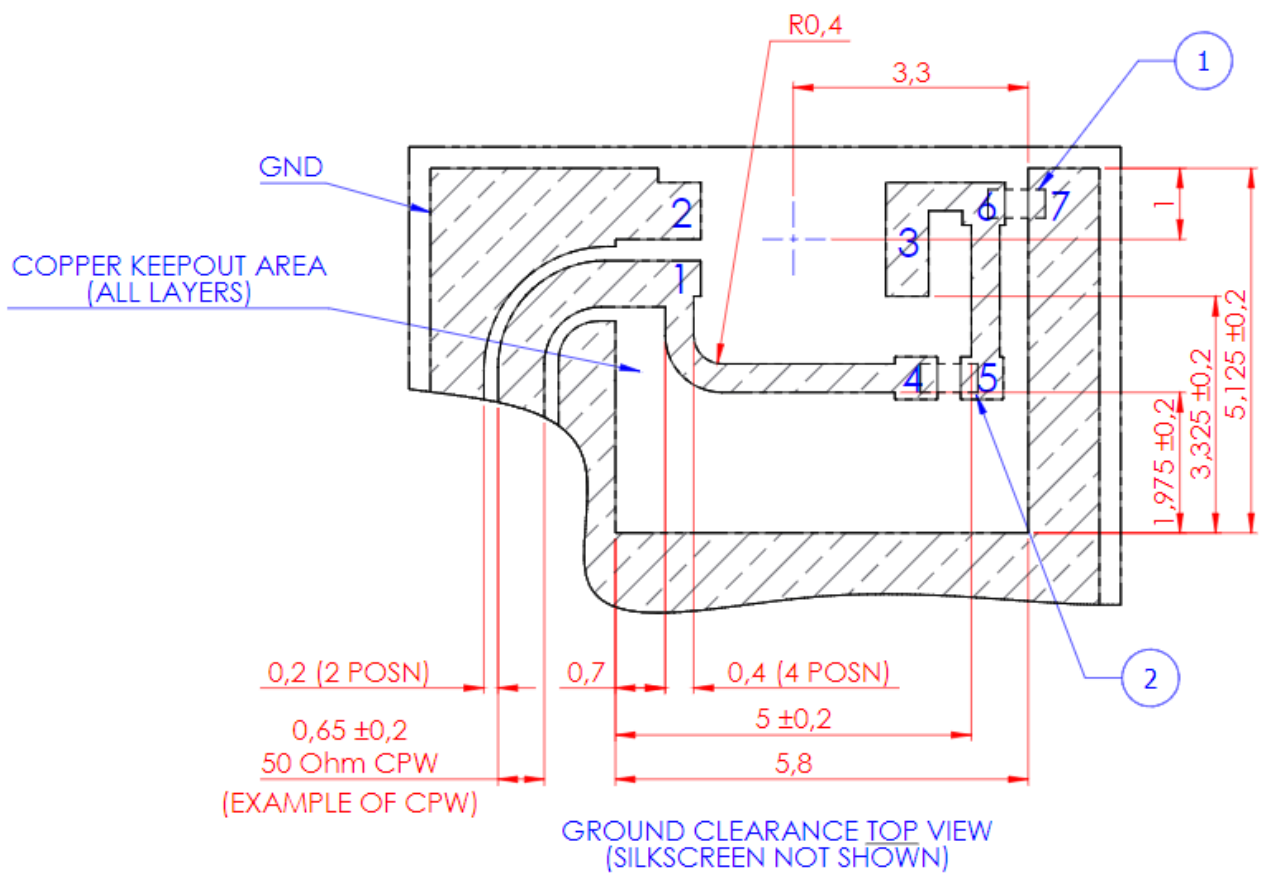
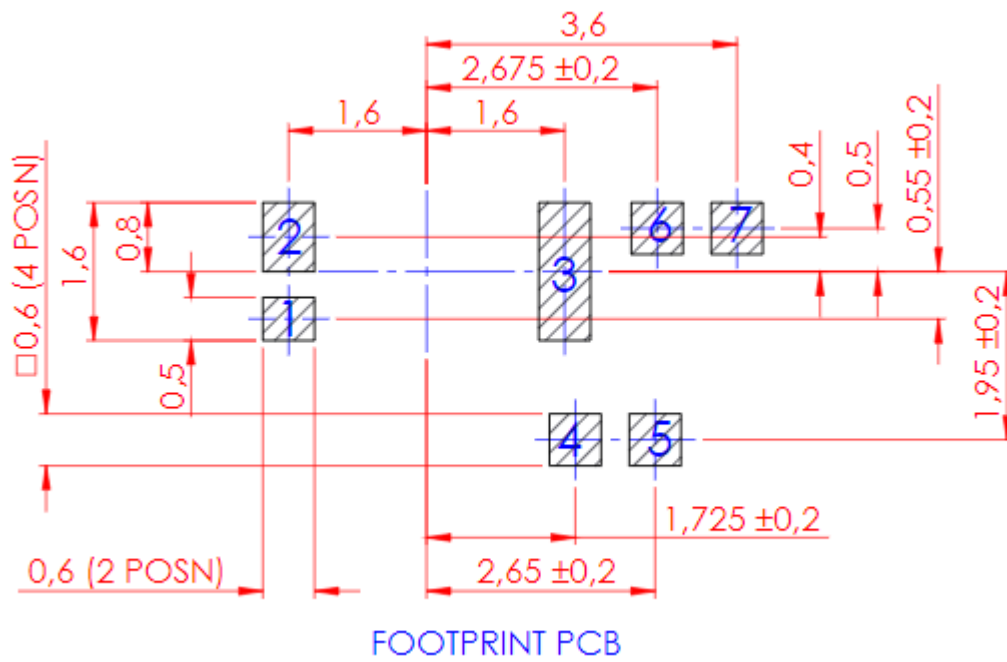

7. Packaging

6000 pc GGBLA.01.A per reel
 Dimensions - Ø330*20mm
 Weight - 700g

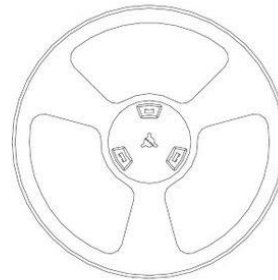

9 Reels / 54000 pcs in one carton
 Carton Dimensions - 350*350*210mm
 Weight - 5.6Kg

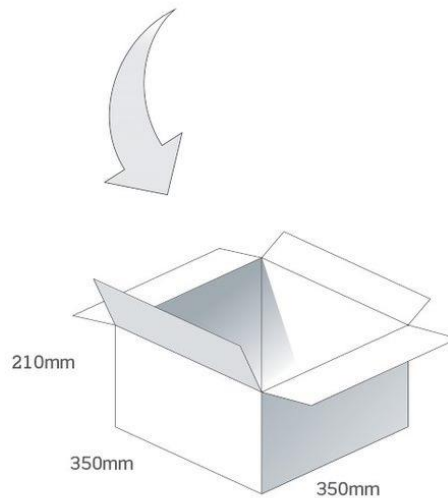

Pallet Dimensions 1200mm*1000mm*1460mm
 36 Cartons per pallet
 6 Cartons per layer
 6 Layers

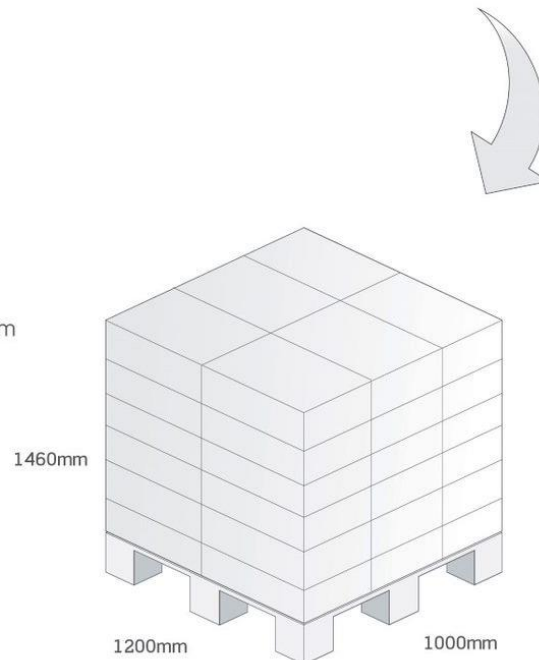

Changelog for the datasheet

SPE-13-8-092 – GGBLA.01.A

Revision: M (Current Version)

Date:	2022-03-04
Changes:	Updated Mechanical & Footprint drawings.
Changes Made by:	Gary West

Previous Revisions

Revision: L (Current Version)

Date:	2021-09-21
Changes:	Added MSL rating.
Changes Made by:	Erik Landi

Revision: G

Date:	2017-06-26
Changes:	
Changes Made by:	Technical Writer

Revision: K

Date:	2021-05-20
Changes:	Template Updated & Integration Guide Added.
Changes Made by:	Gary West

Revision: F

Date:	2017-05-12
Changes:	
Changes Made by:	Technical Writer

Revision: J

Date:	2020-07-31
Changes:	Packaging update.
Changes Made by:	David Connolly

Revision: E

Date:	2017-01-06
Changes:	Updated spec as per amended drawing on PCN and added disclaimer.
Changes Made by:	Andy Mahoney

Revision: I

Date:	2018-03-19
Changes:	Updating max storage temp to 105C.
Changes Made by:	Technical Writer

Revision: D

Date:	2014-11-24
Changes:	
Changes Made by:	Technical Writer

Revision: H

Date:	2018-03-13
Changes:	New Packaging drawing
Changes Made by:	Carol Faughnan

Revision: C

Date:	2014-01-31
Changes:	Removed U from antenna photo.
Changes Made by:	Aine Doyle

Previous Revisions (Continued)

Revision: B	
Date:	2014-01-13
Changes:	Added in product name.
Changes Made by:	Aine Doyle

Revision: A (Original First Release)	
Date:	2017-08-10
Notes:	
Author:	



TAOGLAS®

www.taoglas.com

