

# It's all about SAFETY. *HUBBELL SAFE.*



## ***Tamper-Resistant Receptacles***

*—the new standard in electrical safety.*



Spring-loaded shutter mechanism allows plugs to enter—but resists access to single-pronged items like keys, hairpins, or nails.

### **The NEC® 2008 code:**

NEC Article 406.11 requires tamper-resistant receptacles for dwelling units. "In all areas specified in 210.52, all 125 volt 15- and 20-ampere receptacles shall be listed tamper-resistant receptacles." Article 210.52 specifies where receptacles shall be installed.

### **What this means to you:**

All 15- and 20-amp, 125 volt residential receptacles must be of a type classified and listed as Tamper-Resistant (TR). This includes duplexes, GFCIs, single receptacles, clock hangers, floor boxes, and other specialty products with outlets. Receptacles, even if dedicated to a specific use and not readily accessible, must be tamper-resistant.

This affects all new construction and major renovations for single- and multi-family homes. In some instances, hotel rooms and college dormitories are classified as dwelling units.















## Why Tamper-Resistant?

The tamper-resistant code requirement is all about safety.

- Approximately 2,400 children per year suffer electrical outlet related injuries.
- For years, the design and use of tamper-resistant receptacles have been proven effective in pediatric areas and hospital installations nationwide. It makes sense to have them in homes.
- The additional cost per device is minimal and well worth it.
- Required by states that adopt 2008 NEC®.

## Tamper-Resistant Receptacles







						
	Standard Duplex Self-Grounding 15A 125V	Standard Duplex Quick Thread 15A 125V	Decorator Duplex Self-Grounding 15A 125V	Standard Duplex Cut Ears 15A 125V	Standard Single Receptacle 15A 125V	Standard Single Receptacle 20A 125V
Almond	RR15SALTR	RR15QALTR	RRD15SALTR	RR15KALTR	RR151ALTR	RR201ALTR
Black	RR15SBKTR	RR15QBKTR	RRD15SBKTR	RR15KBKTR	RR151BKTR	RR201BKTR
Brown	RR15STR	RR15QTR	RRD15STR	RR15KTR	RR151TR	RR201TR
Gray	—	—	RRD15SGYTR	—	RR151GYTR	RR201GYTR
Ivory	RR15SITR	RR15QITR	RRD15SITR	RR15KITR	RR151ITR	RR201ITR
Light Almond	RR15SLATR	RR15QLATR	RRD15SLATR	RR15KLATR	RR151LATR	RR201LATR
White	RR15SWTR	RR15QWTR	RRD15SWTR	RR15KWTR	RR151WTR	RR201WTR
						
	Decorator Single Receptacle 15A 125V	Decorator Single Receptacle 20A 125V	Standard Combo SP Switch 15A 120V Receptacle 15A 125V	Standard Combo 3W Switch 15A 120V Receptacle 15A 125V	Decorator Combo SP Switch 15A 120V Receptacle 15A 125V	Decorator Combo 3W Switch 15A 120V Receptacle 15A 125V
Almond	RRD151ALTR	RRD201ALTR	RC108ALTR	RC308ALTR	RCD108ALTR	RCD308ALTR
Black	RRD151BKTR	RRD201BKTR	—	—	RCD108BKTR	RCD308BKTR
Brown	RRD151TR	RRD201TR	RC108TR	RC308TR	—	—
Gray	RRD151GYTR	RRD201GYTR	—	—	RCD108GYTR	RCD308GYTR
Ivory	RRD151ITR	RRD201ITR	RC108ITR	RC308ITR	RCD108ITR	RCD308ITR
Light Almond	RRD151LATR	RRD201LATR	RC108LATR	RC308LATR	RCD108LATR	RCD308LATR
White	RRD151WTR	RRD201WTR	RC108WTR	RC308WTR	RCD108WTR	RCD308WTR

## Increasing awareness of child electrical safety





The National Electrical Manufacturers Association has developed a program titled *Real Safety* that identifies the dangers electrical receptacles may pose to children, educating users about tamper-resistant receptacle function. *Real Safety* targets electrical professionals, inspectors, distributors, builders and new homeowners. For more information visit the website at [www.childoutletsafety.org](http://www.childoutletsafety.org).

## Tamper-Resistant GFCIs and Specialty Items



					
	GFCI Duplex 15A 125V	GFCI Duplex 20A 125V	GFCI Combo SP Switch 15A 120V Receptacle 15A 125V	JLOAD™ Multimedia Outlet 15A & Jacks	JLOAD™ Multimedia Outlet 20A & Jacks
Almond	GFTR15AL	GFTR20AL	GFSP15TRAL	RJ650ALTR	RJ620ALTR
Black	GFTR15BK	GFTR20BK	GFSP15TRBK	RJ650BKTR	RJ620BKTR
Brown	GFTR15	GFTR20	GFSP15TR	—	—
Gray	GFTR15GY	GFTR20GY	GFSP15TRGY	RJ650GYTR	RJ620GYTR
Ivory	GFTR15I	GFTR20I	GFSP15TRI	RJ650ITR	RJ620ITR
Light Almond	GFTR15LA	GFTR20LA	GFSP15TRLA	RJ650LATR	RJ620LATR
White	GFTR15W	GFTR20W	GFSP15TRW	RJ650WTR	RJ620WTR

  

					
	Clock Hanger 15A 125V	Single Receptacle Floor Box 15A 125V	Duplex Receptacle Floor Box Metal 15A 125V	Duplex Receptacle Floor Box Slab-on-grade 15A 125V	Drop-in Floor Box 15A 125V
Almond	—	—	RF515AL	RF406AL*	—
Black	—	—	RF515BK	RF406BK*	—
Brown	—	—	RF515BN	—	—
Ivory	RR151CHITR	—	—	—	—
White	RR151CHWTR	—	—	—	—
Brass	RR151CHBSTR	RF151TR	RF515BS	RF406BS*	RF151R*
Stainless	RR151CHSSTR	—	RF515SS	—	—

\* Not CSA Approved

## Residential Tamper-Resistant Performance

Protection is always there with the tamper-resistant receptacles. It is reliable, automatic and permanent. With attention to design and performance, Hubbell has developed a new shutter mechanism to enable tamper-resistance to be built into standard and decorator duplexes, single receptacles, floor boxes and other power devices. At Hubbell, performance is our history, safety is our goal—now for your home.

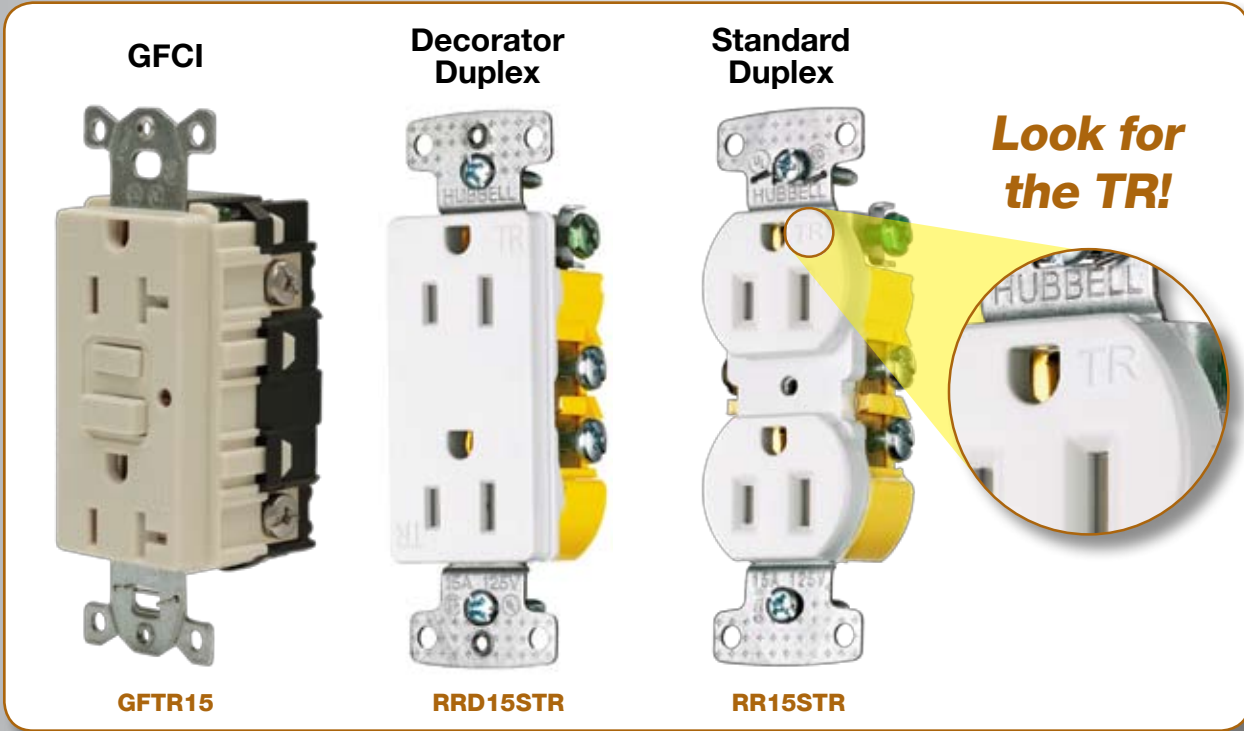

### Built-In Safety Action

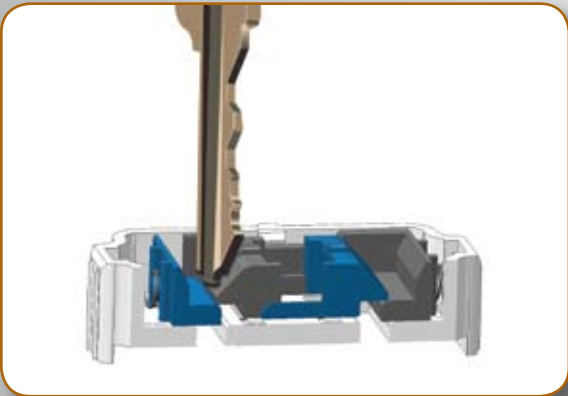

Spring-loaded shutter mechanism restricts access to an object in any one side of the receptacle.

### Power When Needed

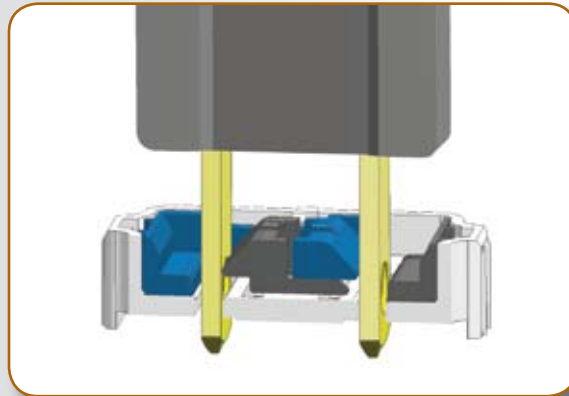

Insertion of a two or three bladed plug will open the shutters, allowing electrical contact.

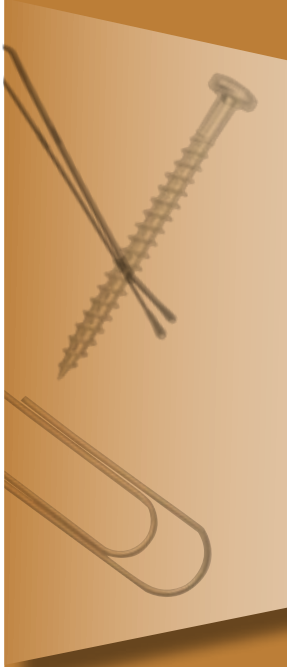

Setting Standards for Excellence