

GD30MPS12H

1200V 30A SiC Schottky MPS™ Diode



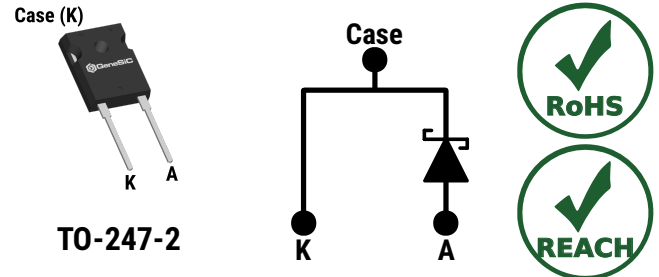
Silicon Carbide Schottky Diode

V_{RRM}	=	1200 V
$I_F (T_C = 148^\circ\text{C})$	=	30 A
Q_C	=	97 nC

Features

- Gen4 Thin Chip Technology for Low V_F
- Superior Figure of Merit $Q_C \cdot V_F$
- 100% Avalanche (UIL) Tested
- Enhanced Surge Current Withstand Capability
- Temperature Independent Fast Switching
- Low Thermal Resistance
- Positive Temperature Coefficient of V_F
- High dV/dt Ruggedness

Package



Advantages

- Improved System Efficiency
- High System Reliability
- Optimal Price Performance
- Reduced Cooling Requirements
- Increased System Power Density
- Zero Reverse Recovery Current
- Easy to Parallel without Thermal Runaway
- Enables Extremely Fast Switching

Applications

- Power Factor Correction (PFC)
- Electric Vehicles and Battery Chargers
- Solar Inverters
- High Frequency Converters
- Switched Mode Power Supply (SMPS)
- Motor Drives
- Anti-Parallel / Free-Wheeling Diode
- Induction Heating & Welding

Absolute Maximum Ratings (At $T_C = 25^\circ\text{C}$ Unless Otherwise Stated)

Parameter	Symbol	Conditions	Values	Unit	Note
Repetitive Peak Reverse Voltage	V_{RRM}		1200	V	
Continuous Forward Current	I_F	$T_C = 100^\circ\text{C}, D = 1$	55	A	Fig. 4
		$T_C = 135^\circ\text{C}, D = 1$	38		
		$T_C = 148^\circ\text{C}, D = 1$	30		
Non-Repetitive Peak Forward Surge Current, Half Sine Wave	I_{FSM}	$T_C = 25^\circ\text{C}, t_P = 10 \text{ ms}$	240	A	
		$T_C = 150^\circ\text{C}, t_P = 10 \text{ ms}$	192		
Repetitive Peak Forward Surge Current, Half Sine Wave	I_{FRM}	$T_C = 25^\circ\text{C}, t_P = 10 \text{ ms}$	144	A	
		$T_C = 150^\circ\text{C}, t_P = 10 \text{ ms}$	100		
Non-Repetitive Peak Forward Surge Current	I_{FMAX}	$T_C = 25^\circ\text{C}, t_P = 10 \mu\text{s}$	1200	A	
i^2t Value	$\int i^2 dt$	$T_C = 25^\circ\text{C}, t_P = 10 \text{ ms}$	288	A^2s	
Non-Repetitive Avalanche Energy	E_{AS}	$L = 0.6 \text{ mH}, I_{AS} = 30 \text{ A}$	271	mJ	
Diode Ruggedness	dV/dt	$V_R = 0 \sim 960 \text{ V}$	200	V/ns	
Power Dissipation	P_{TOT}	$T_C = 25^\circ\text{C}$	313	W	Fig. 3
Operating and Storage Temperature	T_j, T_{stg}		-55 to 175	$^\circ\text{C}$	

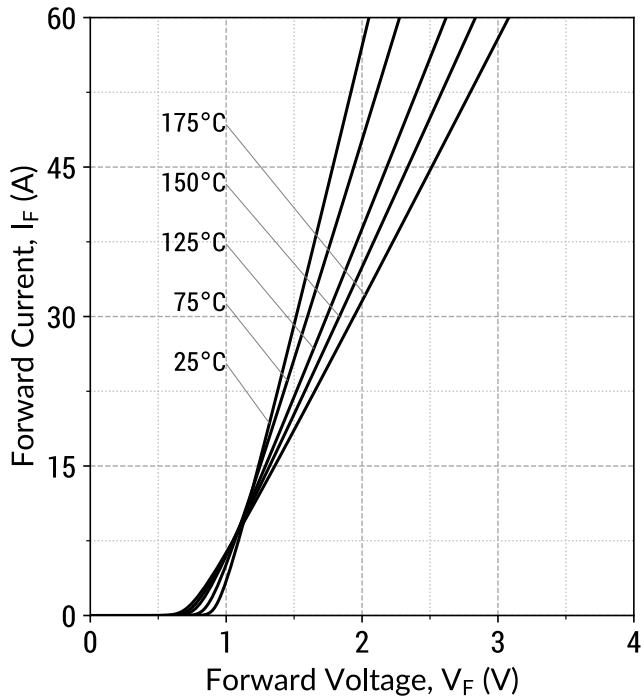
Electrical Characteristics

Parameter	Symbol	Conditions	Values			Unit	Note
			Min.	Typ.	Max.		
Diode Forward Voltage	V_F	$I_F = 30\text{ A}, T_j = 25^\circ\text{C}$		1.5	1.8	V	Fig. 1
		$I_F = 30\text{ A}, T_j = 175^\circ\text{C}$		1.9			
Reverse Current	I_R	$V_R = 1200\text{ V}, T_j = 25^\circ\text{C}$		2	20	μA	Fig. 2
		$V_R = 1200\text{ V}, T_j = 175^\circ\text{C}$		20			
Total Capacitive Charge	Q_C	$I_F \leq I_{F,MAX}$ $di_F/dt = 200\text{ A}/\mu\text{s}$	$V_R = 400\text{ V}$		67	nC	Fig. 7
			$V_R = 800\text{ V}$		97		
Switching Time	t_s	$di_F/dt = 200\text{ A}/\mu\text{s}$	$V_R = 400\text{ V}$	< 10		ns	
			$V_R = 800\text{ V}$				
Total Capacitance	C	$V_R = 1\text{ V}, f = 1\text{ MHz}$		1101		pF	Fig. 6
		$V_R = 800\text{ V}, f = 1\text{ MHz}$		64			

Thermal/Package Characteristics

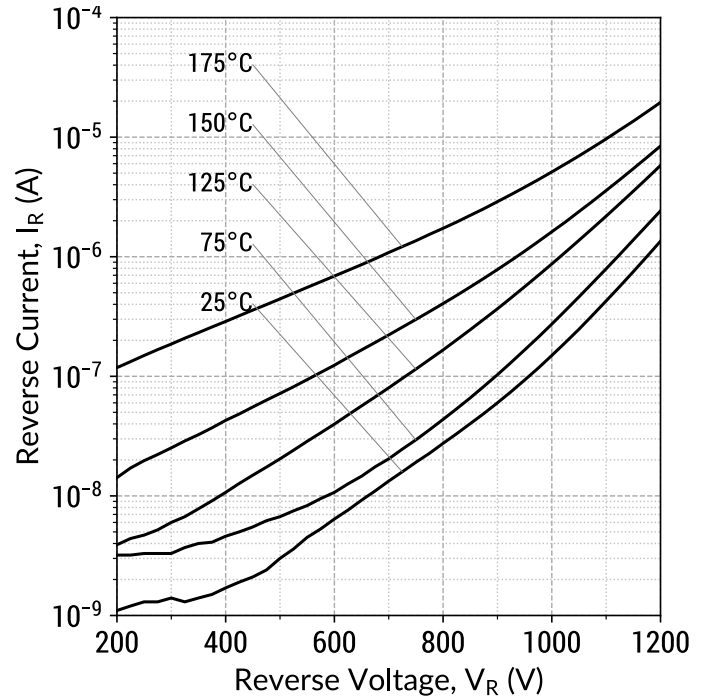
Parameter	Symbol	Conditions	Values			Unit	Note
			Min.	Typ.	Max.		
Thermal Resistance, Junction - Case	R_{thJC}			0.48		$^\circ\text{C}/\text{W}$	Fig. 9
Weight	W_T			6.0		g	
Mounting Torque	T_M	Screws to Heatsink			1.1	Nm	

Figure 1: Typical Forward Characteristics



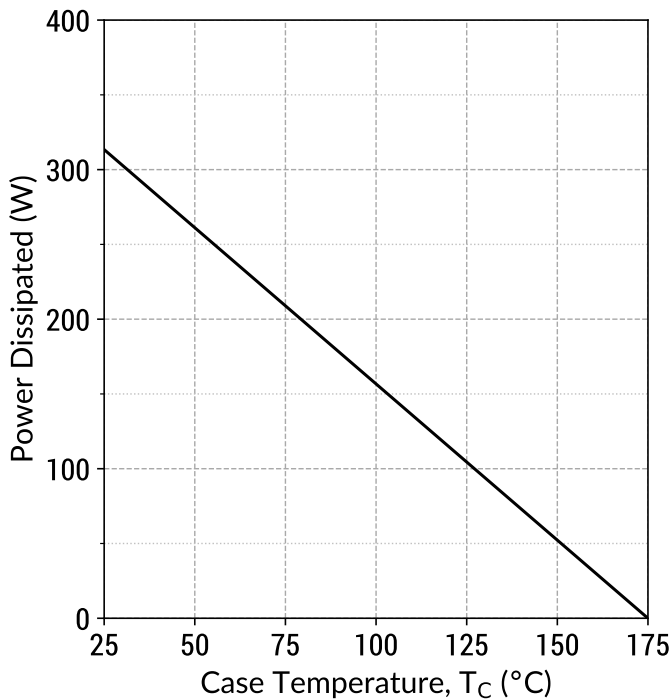
$$I_F = f(V_F, T_j); t_P = 250 \mu s$$

Figure 2: Typical Reverse Characteristics



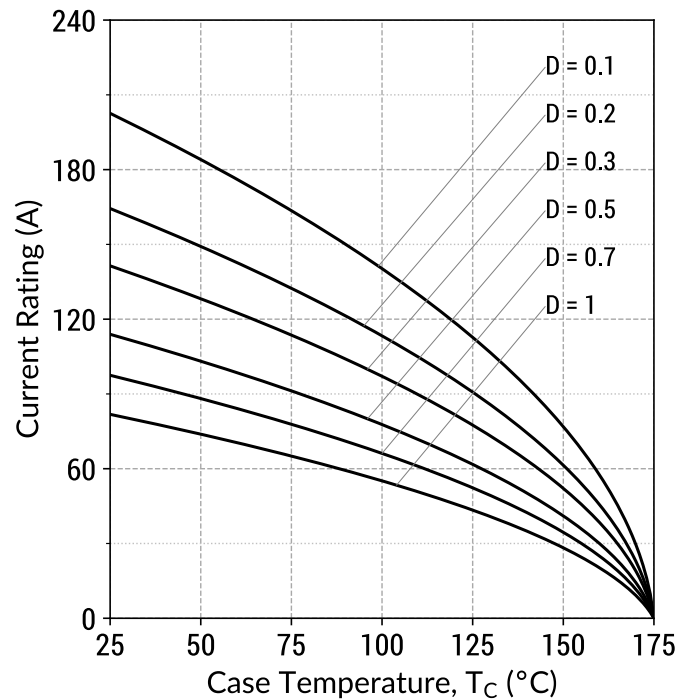
$$I_R = f(V_R, T_j)$$

Figure 3: Power Derating Curves



$$P_{TOT} = f(T_C); T_j = 175^\circ C$$

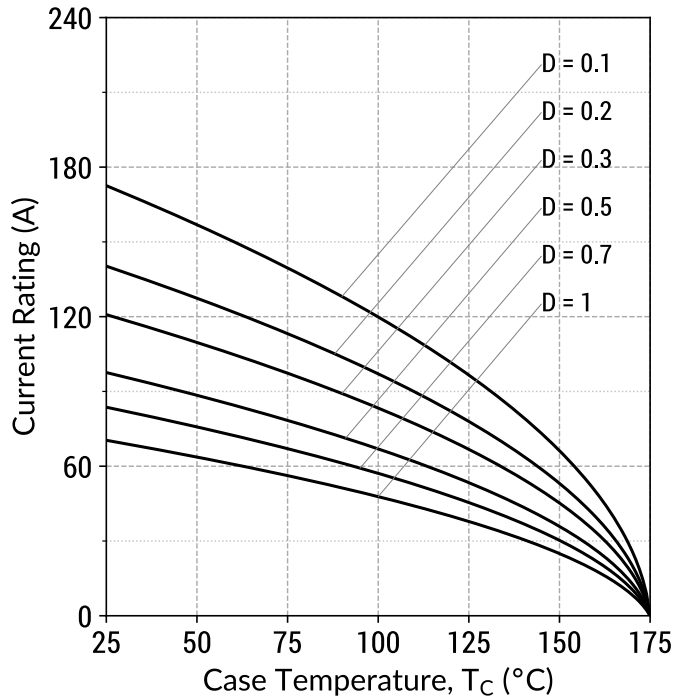
Figure 4: Current Derating Curves (Typical V_F)



$$I_F = f(T_C); D = t_P/T; T_j \leq 175^\circ C; f_{sw} > 10kHz$$

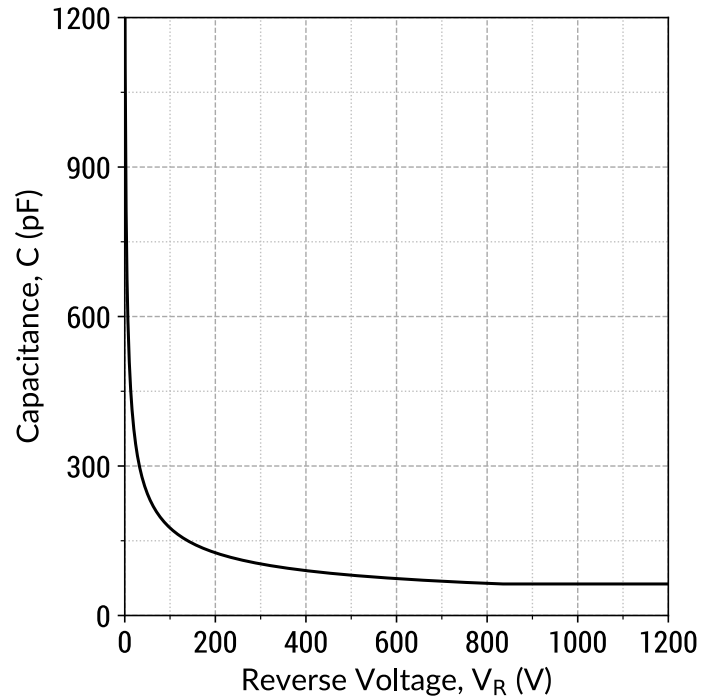


Figure 5: Current Derating Curves (Maximum V_F)



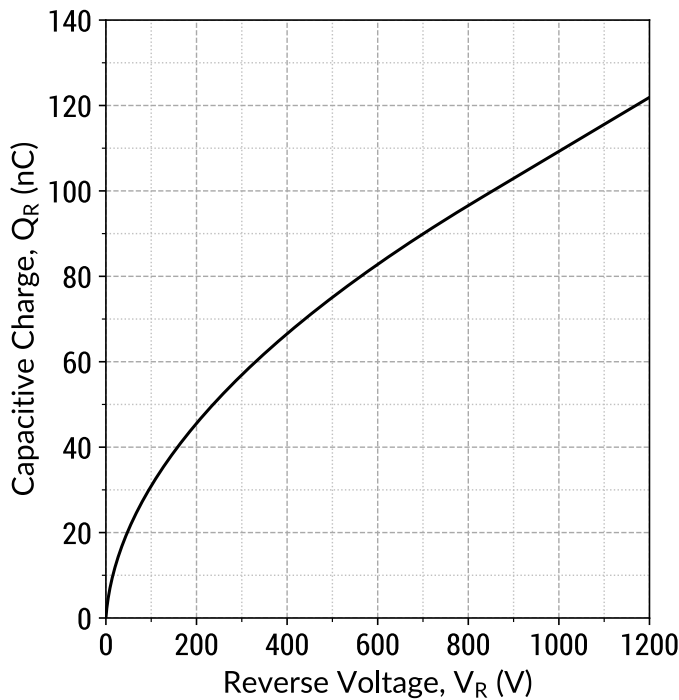
$I_F = f(T_C)$; $D = t_P/T$; $T_J \leq 175^\circ\text{C}$; $f_{SW} > 10\text{kHz}$

Figure 6: Typical Junction Capacitance vs Reverse Voltage Characteristics



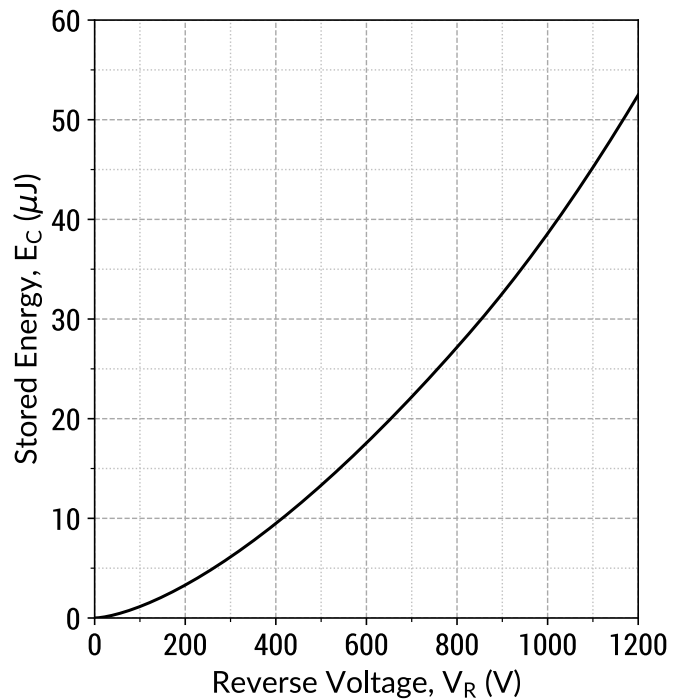
$C = f(V_R)$; $f = 1\text{MHz}$

Figure 7: Typical Capacitive Charge vs Reverse Voltage Characteristics



$Q_C = f(V_R)$; $f = 1\text{MHz}$

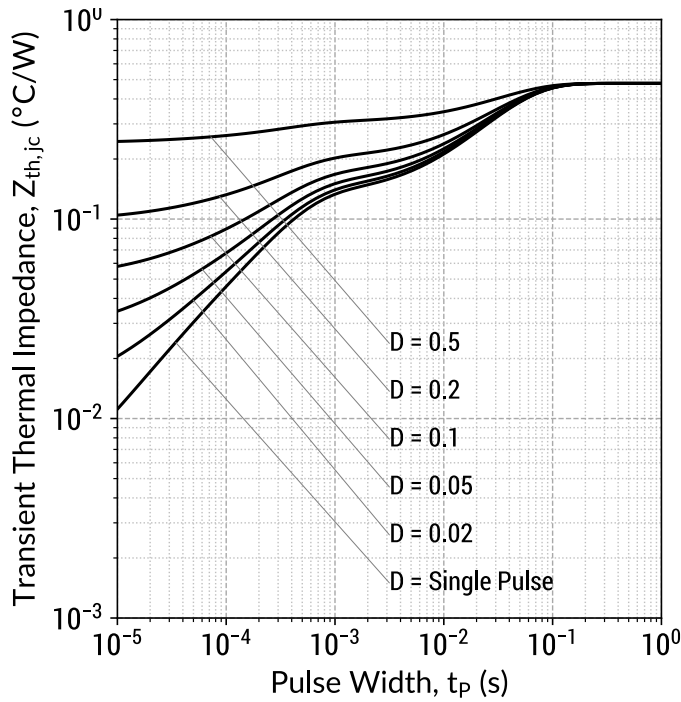
Figure 8: Typical Capacitive Energy vs Reverse Voltage Characteristics



$E_C = f(V_R)$; $f = 1\text{MHz}$



Figure 9: Transient Thermal Impedance



$$Z_{th,jc} = f(t_p, D); D = t_p/T$$

Figure 10: Forward Curve Model



$$I_F = f(V_F, T_j)$$

Forward Curve Model Equation:

$$I_F = (V_F - V_{BI})/R_{DIFF} \text{ (A)}$$

Built-In Voltage (V_{BI}):

$$V_{BI}(T_j) = m \times T_j + n \text{ (V)}$$

$$m = -0.00119 \text{ (V/°C)}$$

$$n = 1.01 \text{ (V)}$$

Differential Resistance (R_{DIFF}):

$$R_{DIFF}(T_j) = a \times T_j^2 + b \times T_j + c \text{ (}\Omega\text{)}$$

$$a = 3.97e-07 \text{ (}\Omega\text{/°C}^2\text{)}$$

$$b = 5.5e-05 \text{ (}\Omega\text{/°C)}$$

$$c = 0.0163 \text{ (}\Omega\text{)}$$

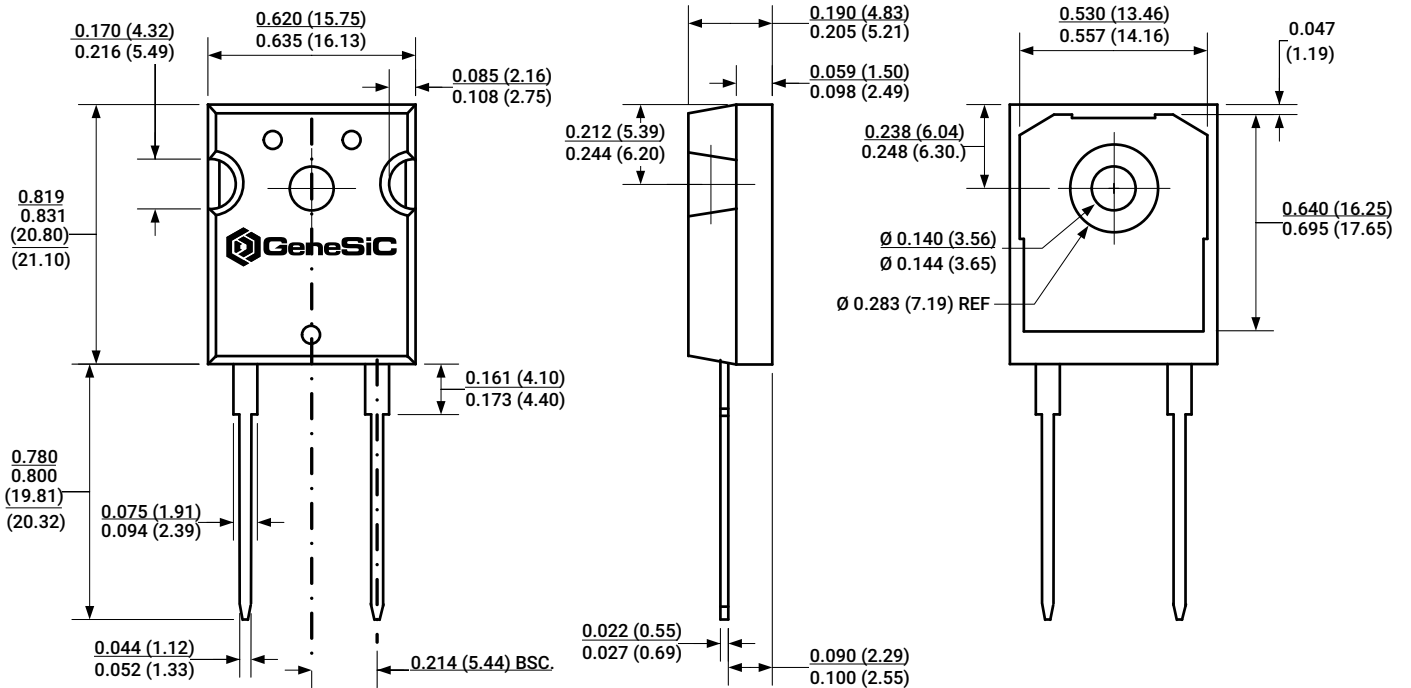
Forward Power Loss Equation:

$$P_{LOSS} = V_{BI}(T_j) \times I_{AVG} + R_{DIFF}(T_j) \times I_{RMS}^2$$

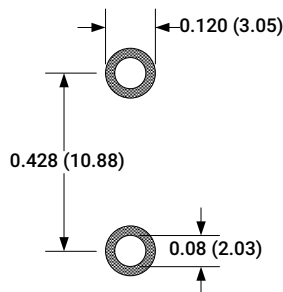


Package Dimensions

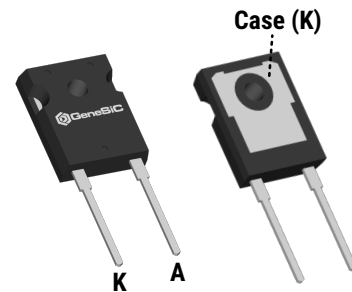
TO-247-2 Package Outline



Recommended Solder Pad Layout



Package View



NOTE

1. CONTROLLED DIMENSION IS INCH. DIMENSION IN BRACKET IS MILLIMETER.
2. DIMENSIONS DO NOT INCLUDE END FLASH, MOLD FLASH, MATERIAL PROTRUSIONS.



Compliance

RoHS Compliance

The levels of RoHS restricted materials in this product are below the maximum concentration values (also referred to as the threshold limits) permitted for such substances, or are used in an exempted application, in accordance with EU Directive 2011/65/EC (RoHS 2), as adopted by EU member states on January 2, 2013 and amended on March 31, 2015 by EU Directive 2015/863. RoHS Declarations for this product can be obtained from your GeneSiC representative.

REACH Compliance

REACH substances of high concern (SVHCs) information is available for this product. Since the European Chemical Agency (ECHA) has published notice of their intent to frequently revise the SVHC listing for the foreseeable future, please contact a GeneSiC representative to insure you get the most up-to-date REACH SVHC Declaration. REACH banned substance information (REACH Article 67) is also available upon request.

Disclaimer

GeneSiC Semiconductor, Inc. reserves right to make changes to the product specifications and data in this document without notice. GeneSiC disclaims all and any warranty and liability arising out of use or application of any product. No license, express or implied to any intellectual property rights is granted by this document.

Unless otherwise expressly indicated, GeneSiC products are not designed, tested or authorized for use in life-saving, medical, aircraft navigation, communication, air traffic control and weapons systems, nor in applications where their failure may result in death, personal injury and/or property damage.

Related Links

- SPICE Models: https://www.genesicsemi.com/sic-schottky-mps/GD30MPS12H/GD30MPS12H_SPICE.zip
- PLECS Models: https://www.genesicsemi.com/sic-schottky-mps/GD30MPS12H/GD30MPS12H_PLECS.zip
- CAD Models: https://www.genesicsemi.com/sic-schottky-mps/GD30MPS12H/GD30MPS12H_3D.zip
- Evaluation Boards: <https://www.genesicsemi.com/technical-support>
- Reliability: <https://www.genesicsemi.com/reliability>
- Compliance: <https://www.genesicsemi.com/compliance>
- Quality Manual: <https://www.genesicsemi.com/quality>

Revision History

- Rev 21/Sep: Initial Release



www.genesicsemi.com/sic-schottky-mps/

