

GCJ32QR72J103KXJ1#

"#" indicates a package specification code.



< List of part numbers with package codes >
GCJ32QR72J103KXJ1L , GCJ32QR72J103KXJ1K

Shape

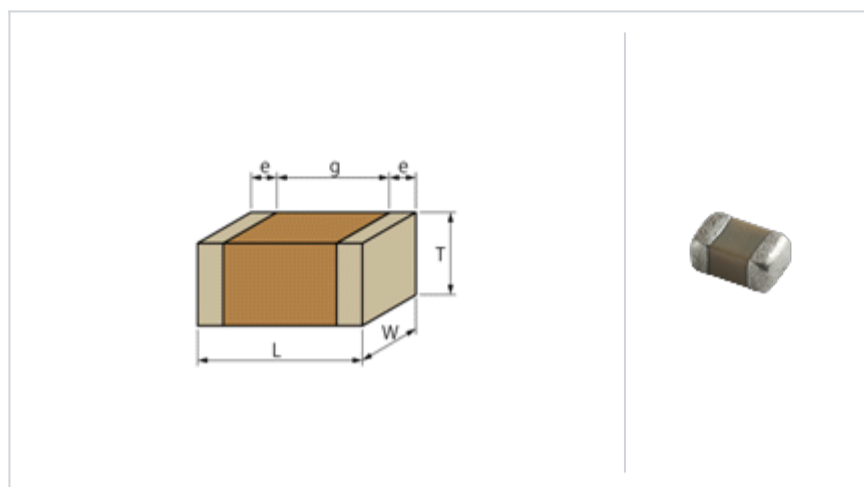

| | |
|---------------------------------------|-----------------|
| L size | 3.2 ± 0.3mm |
| W size | 2.5 ± 0.2mm |
| T size | 1.5 +0.0/-0.3mm |
| External terminal width e | 0.3mm min. |
| Distance between external terminals g | 1.2mm min. |
| Size code in inch(mm) | 1210 (3225) |

Notes

Resin external electrode products

References

| Packaging | Specifications | Minimum quantity |
|-----------|-----------------------|------------------|
| L | 180mm Embossed taping | 2000 |
| K | 330mm Embossed taping | 8000 |

| Mass (typ.) | |
|-------------|------|
| 1 piece | 74mg |

Specifications

| | |
|--|---------------|
| Capacitance | 10000pF ± 10% |
| Rated voltage | 630Vdc |
| Temperature characteristics (complied standard) | X7R(EIA) |
| Capacitance change rate | ± 15.0% |
| Temperature range of temperature characteristics | -55 to 125 |
| Operating temperature range | -55 to 125 |

⚠ Attention

- 1.This datasheet is downloaded from the website of Murata Manufacturing Co., Ltd. Therefore, it ' s specifications are subject to change or our products in it may be discontinued without advance notice. Please check with our sales representatives or product engineers before ordering.
- 2.This datasheet has only typical specifications because there is no space for detailed specifications. Therefore, please review our product specifications or consult the approval sheet for product specifications before ordering.

▪ Frequency characteristics (ESR, Impedance)

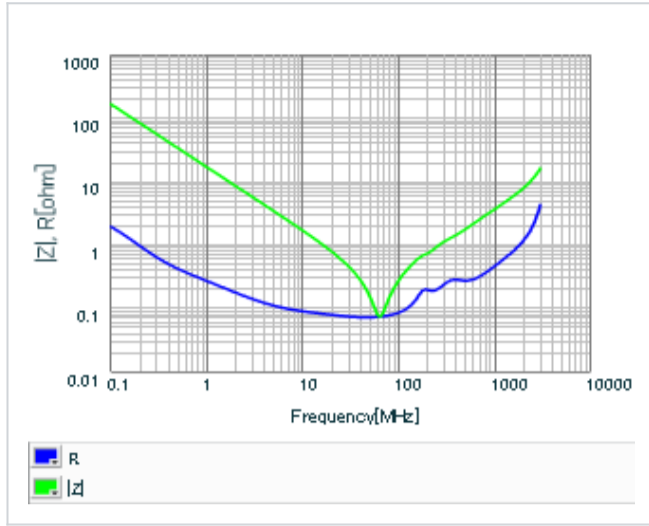

▪ S parameter (Smith chart S11)

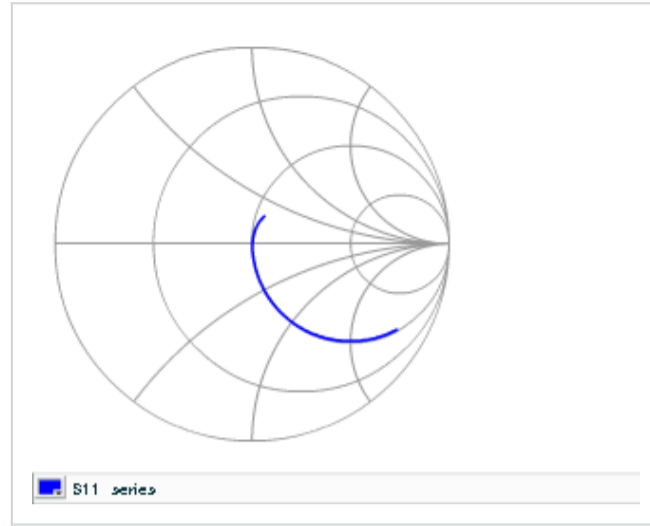

▪ DC bias characteristics

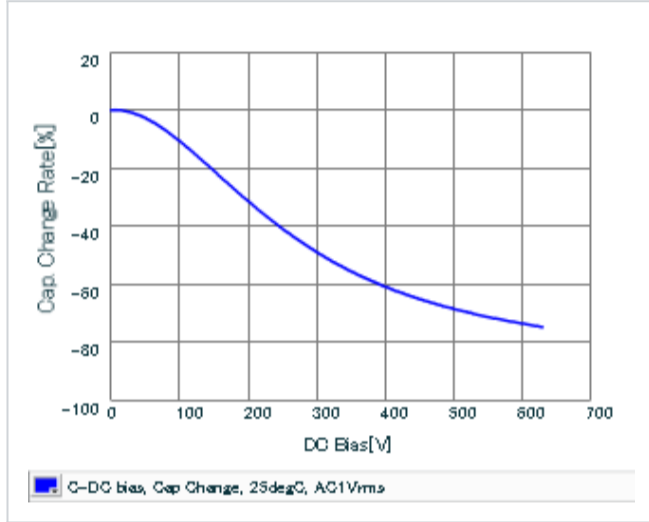

▪ AC voltage characteristics

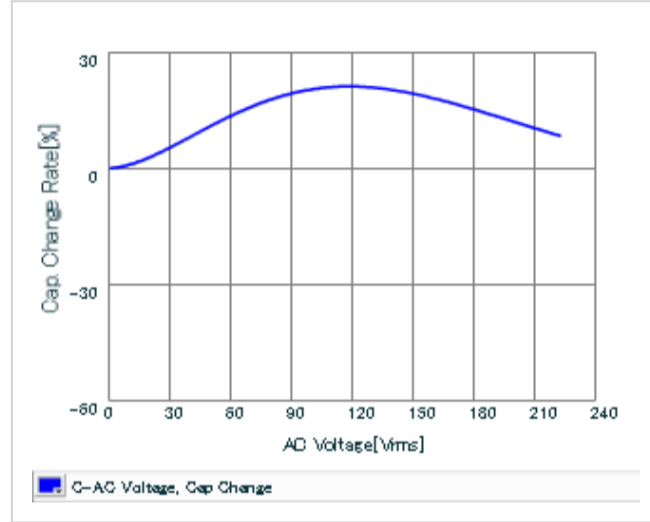

▪ Capacitance - temperature characteristics

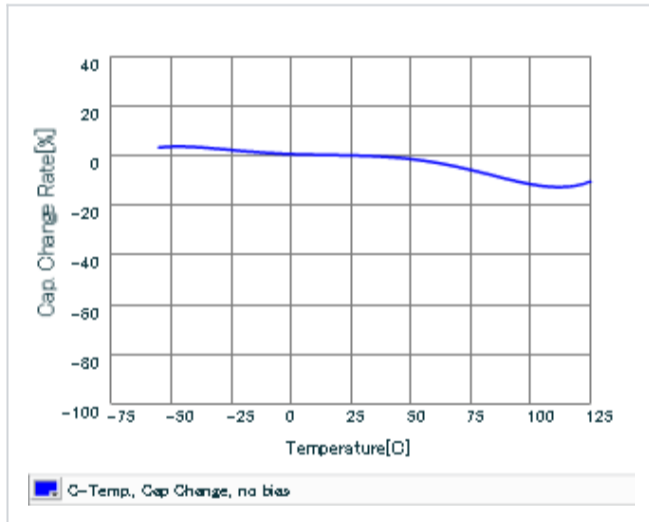

▪ Calorific property by ripple current

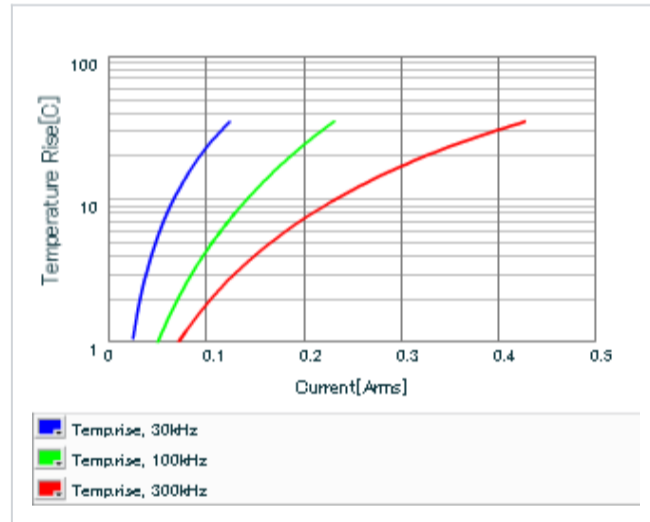

This PDF data has only typical specifications because there is no space for detailed specifications. Therefore, please review our product specifications or consult the approval sheet for product specifications before ordering.