

G8PM Relay

High Power PCB Relay for Automotive and DC 12 V Applications

High Load Relay for Motor/Resistive Control Applications

- Can replace Mini/Power ISO Plug-in type relay
- Small size & High heat resistance enable for usage in engine room
- Can support 60A Fuse
- PIP reflow compliant
- Temperature range -40°C to +125°C



RoHS Compliant

Model Number Legend

G8PM-□□□□□
 1 2 3 4 5

1. Number of Contact Poles

1: 1-pole

2. Contact Form

A: SPST (1 Form A)

3. Contact structure

W: Double contact

4. Protective structure

7: Flux tight (Open vent hole) (RT II IEC61810)

5. Special function

R: Pin in paste compliant type

G
8
P
M

Application Examples

- DC 12V motor/resistive application control
- Automotive DC applications (Smart Junction Box, Main power, Radiator fan, EPS, DC/DC converter, Head lamp, etc.)

Ordering Information

Classification	Contact form	Protective structure	Rated coil voltage (V)	Model	Minimum Packing unit (Tube packing)
High power	SPST 1 Form A double contact	Flux tight (open vent hole) (RT II IEC61810)	DC12	G8PM-1AW7R	1200 pcs. / box (40 pcs. x 30 tubes)

Ratings

●Coil

Rated voltage (V)	Rated current (mA)	Coil resistance (Ω)	Must-operate voltage (V)	Must-release voltage (V)	Permissible voltage Range (V)	Rated Power consumption (mW)	Model
DC12	53.3	225	7.2 Max.	0.8 Min.	10 to 16	640	G8PM-1AW7R

Note 1. The rated current and coil resistance are measured at a coil temperature of 20°C with a tolerance of ±10%.

Note 2. The operating characteristics are measured at a coil temperature of 20°C.

Note 3. The Permissible voltage is the maximum voltage that can be applied to the relay coil.

●Contacts

Item	Classification	High power
	Model	G8PM-1AW7R
Contact Type		Double
Contact material		Ag-alloy (Cd-free)
Rated continuous carry current	20°C	60 A
	125°C	40 A
Max. switching current		150 A Inrush 80 A break *1
Max. carrying current *2	135% fuse rating	81 A at 14 VDC for 1 h
	200% fuse rating	120 A at 14 VDC for 2 mins
Min. switching current		12 VDC 0.1 A

*1. Break current is 14 VDC resistive load 100 cycles at room temperature.

*2. The data is measured at room temperature.

■ Characteristics

Item		G8PM-1AW
Contact resistance (See *1.)		Typ.2.5 mΩ Max. 50 mΩ
Operate time		10 ms max. (12 VDC not including bounce time)
Release time		5 ms max. (12 VDC not including bounce time)
Insulation resistance (See *2.)	Between coil and contacts	100 MΩ min.
	Between contacts of the same polarity	100 MΩ min.
Dielectric strength	Between coil and contacts	500 VAC 1 min
	Between contacts of the same polarity	500 VAC 1 min
Vibration resistance	Destruction	33 Hz, 45 m/s ²
	Malfunction	10 to 500 Hz, 45 m/s ² (detection time 10 μs min)
Shock resistance	Destruction	1,000 m/s ² (pulse duration: 6 ms)
	Malfunction	100 m/s ² (pulse duration: 11 ms detection time: 10 μs)
Mechanical endurance (See *3.)		1,000,000 ops. min.
Electrical endurance (See *4.)	Resistive Load	45 A, 14 VDC, 100,000 operations (1 s On/1 s Off)
	Lamp Load	100 A Inrush/ 20 A break, 14 VDC, 100,000 operations (1 s On/9 s Off)
Ambient operating temperature		-40 to 125°C (without freezing or condensation)
Ambient operating humidity		35% to 85% RH
Weight		Approx. 7.6 g

Note. The above values are initial values at an ambient temperature of 23°C unless otherwise specified.

*1. The contact resistance was measured with 10 A at 12 VDC using the voltage drop method.

*2. The insulation resistance was measured with a 500 VDC megohmmeter.

*3. The mechanical endurance was measured at a switching frequency of 18,000 operations/hr.

*4. Please connect N.O terminal to the +BATT side and connect surge suppression element in parallel between coil based on recommended circuit.

Recommended circuit: (a), (b), (c)

Not-recommended circuit: (d)

Note:

OMRON recommends coil driver circuit (b) and (c) for coil surge suppression. However the circuit (d) is not recommended because it may negatively affect the durability performance.

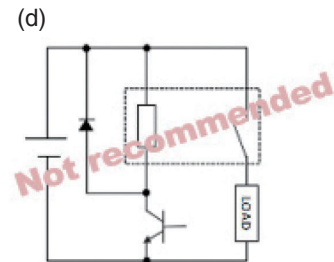
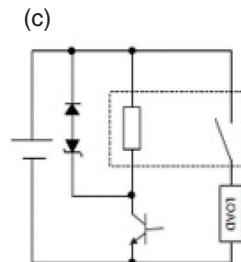
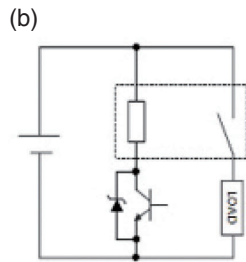
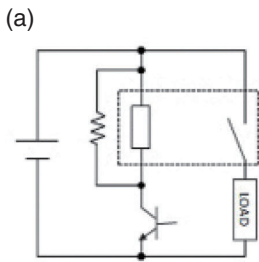

Reference Technical Data

Actual Electrical performance (reference)

Model	Application	Load voltage	Inrush	Steady state	Switching off	Inductance	Ambient temperature	Switching frequency		Required Cycles (min)
		(V)	(A)	(A)	(A)			On (s)	Off (s)	
G8PM-1AW7R	Radiator Fan	13.5	80	30	30		-40 to 110	3.0	8.0	156,000
G8PM-1AW7R	Lamp	14	100	20	20	-	-40 to 110	0.5	5.5	156,000
G8PM-1AW7R	Resistive	14	50	10	10	-	25	2.0	5.0	1,000,000
G8PM-1AW7R	Fuel pump	14.7								
G8PM-1AW7R	Starter Motor	14.5	150	50	50	0.16	-40 to 110	3.0	9.0	156,000

Must-operate Voltage and Must-release Voltage Distributions (Number of Relays × Percentage of Rated Voltage)

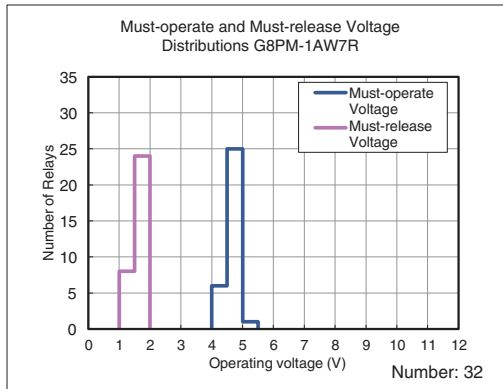

Time Characteristic Distributions (Number of Contacts × Time (ms))

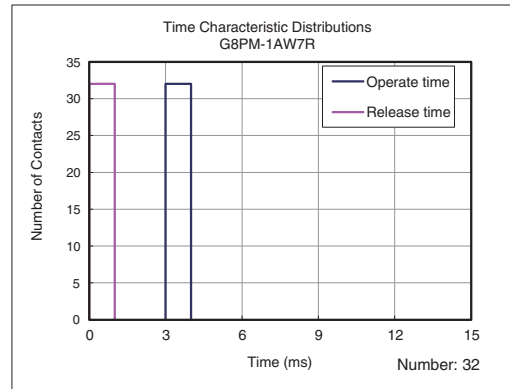

Operating voltage vs ambient temperature (Cold start)

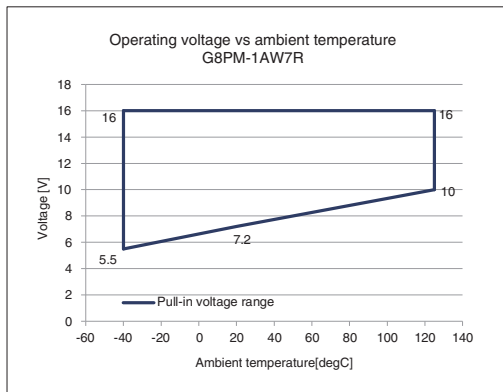

Coil temperature rise [degC]

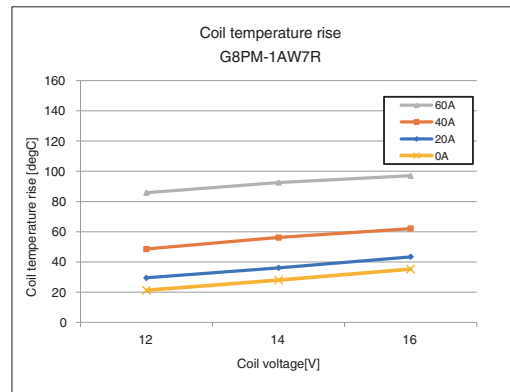

Derating curve

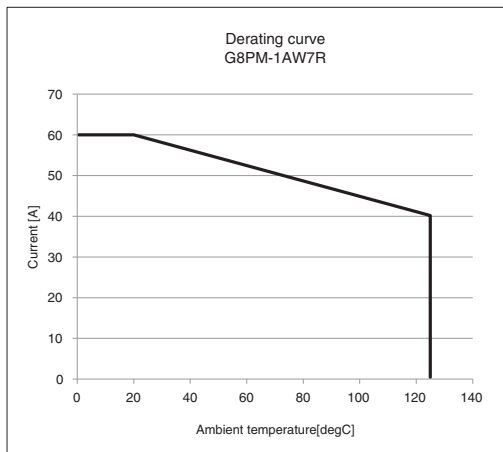

G8PM

High Power PCB Relay for Automotive and DC 12 V Applications

■ Dimensions

CAD Data Please visit our website, which is noted on the last page.

(Unit: mm)

G8PM

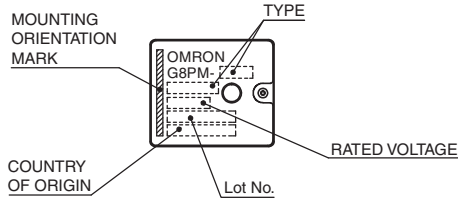

PCB Mounting Holes
(Bottom View)

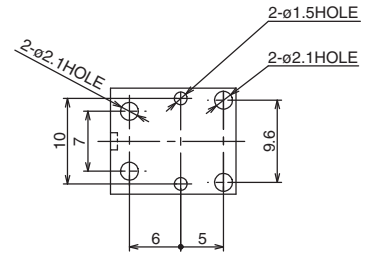

*Please study & choose other appropriate hole diameters if confirmed the diameter values recommended above don't work with the soldering process.

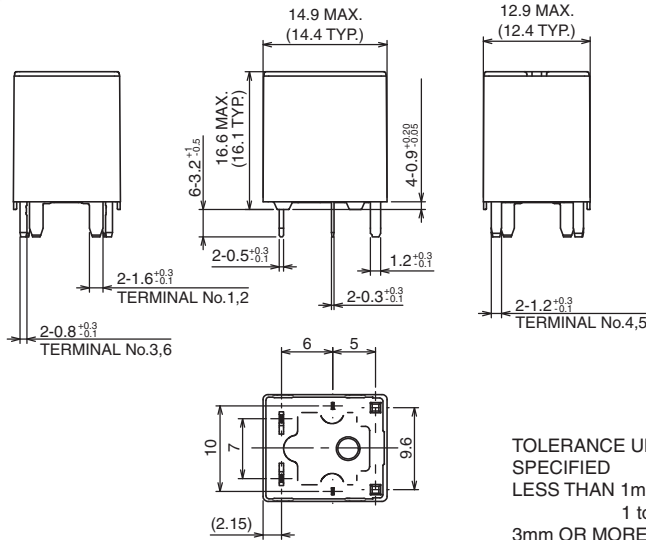

**Terminal Arrangement/
Internal Connections**
(Bottom View)

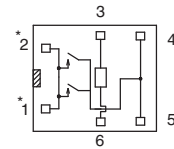

NOTE: *TERMINAL 1&2 CONNECT TO +BATT

TOLERANCE UNLESS OTHERWISE SPECIFIED
 LESS THAN 1mm : ±0.1mm
 1 to 3mm : ±0.2mm
 3mm OR MORE : ±0.3mm

CAD Data

■Precautions

- Please refer to “Safety Precautions for All Automotive Relays” for correct use.

Please check each region's Terms & Conditions by region website.

OMRON Corporation Electronic and Mechanical Components Company

Regional Contact

Americas

<https://www.components.omron.com/>

Asia-Pacific

<https://ecb.omron.com.sg/>

Korea

<https://www.omron-ecb.co.kr/>

Europe

<http://components.omron.eu/>

China

<https://www.ecb.omron.com.cn/>

Japan

<https://www.omron.co.jp/ecb/>