

# G8K Relay

Ultra Miniature Power PCB Relay for Automotive and DC 12 V Applications

## Ultra Miniature Relay Capable for Motor/Control of BCM Applications

- High-density design and extremely small mounting space
- Equivalent capability of switching 14 V 25 A motor load despite of smaller footprint
- Available as 1x Form C package, or 2x Form C (independent) package
- PIP reflow compliant relay
- Temperature range -40°C to +125°C
- 100% modular footprint for 1x relay or 2x relay PCB layout

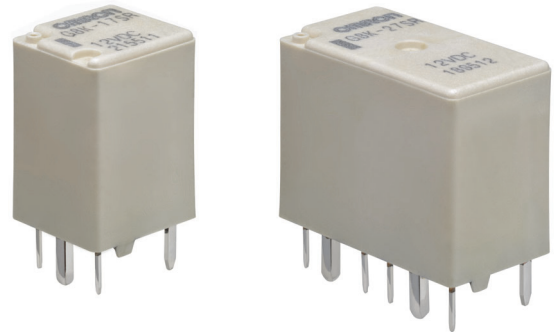

RoHS Compliant

### Model Number Legend

G8K-□□□□  
1 2 3 4

#### 1. Number of Contact Poles/Structure

- 1: SPDT (1 Form C)
- 2: SPDT × 2 (1 Form C × 2)

#### 2. Protective structure

- Blank: Plastic sealed (RT III IEC61810)
- 7 : Flux tight (Open vent hole) (RT II IEC61810)

#### 3. Special function

- Blank: Standard
- S : Low operating voltage
- U : Ultralow operating voltage

#### 4. Special function

- Blank: Standard
- R : Pin in Paste reflow compliant

### Application Examples

- DC 12 V motor/resistive application control
- Automotive DC applications (Door lock, Power window, Power seat, Power slide door closure, Horn, etc.)

### Ordering Information

Classification	Contact form	*Protective structure	Rated coil		Model	Characteristics	Minimum Packing unit (Tube packing)	
			Voltage (V)	Resistance				
Single	SPDT (1 Form C)	Flux tight (open vent hole) (RT II IEC61810)	12	160	G8K-17R	Standard	63 pcs. / Stick 48 sticks / Box Total 3,024 pcs.	
				120	G8K-17SR	Low operating voltage		
				100	G8K-17UR	Ultralow operating voltage		
Twin	SPDT × 2 (1 Form C × 2)	Flux tight (open vent hole) (RT II IEC61810)		160	G8K-27R	Standard		32 pcs. / Stick 48 sticks / Box Total 1,536 pcs.
				120	G8K-27SR	Low operating voltage		
				100	G8K-27UR	Ultralow operating voltage		

\* Please contact our sales representative for other models available

### Ratings

#### Coil

Rated voltage (V)	Rated current (mA)	Coil resistance (Ω)	Must-operate voltage (V)	Must-release voltage (V)	Permissible voltage Range (V)	Rated Power consumption (mW)	Model	
							Single	Twin
DC12	75	160	6.9 Max.	1.0 Min.	10 to 16	900	G8K-17R	G8K-27R
	100	120	6.0 Max.			1200	G8K-17SR	G8K-27SR
	120	100	5.6 Max.	0.7 Min.		1440	G8K-17UR	G8K-27UR

Note 1. The rated current and coil resistance are measured at a coil temperature of 20°C with a tolerance of ±10%.

Note 2. The operating characteristics are measured at a coil temperature of 20°C.

Note 3. The Permissible voltage is the maximum voltage that can be applied to the relay coil.

### ●Contacts

Item	Classification Model	Standard	Low operating voltage	Ultralow operating voltage
		G8K-17R G8K-27R	G8K-17SR G8K-27SR	G8K-17UR G8K-27UR
Contact material		Silver-alloy		
Max. switching current (N.O)		30 A		
Max. carrying current *1	at 20°C	35 A 30 s *2		-
	at 105°C	30 A 30 s *2		30 A 30 s *2
	at 125°C	20 A 30 s *2		-
Min. switching current		12 VDC 1 A		

- \*1. This does not guarantee repeated condition. Also depends on the connecting conditions.  
Ultralow operating voltage version is not designed for continuous use. Please contact our sales if you have specific conditions.
- \*2. Applicable when the single model or the single part of twin model operates.

### ■Characteristics

Item	Standard value	
	Single	Twin
Contact resistance (See *1.)	Typ.5 mΩ max.50 mΩ	
Operate time	10 ms max. (12 VDC not including bounce time)	
Release time	5 ms max. (12 VDC not including bounce time)	
Insulation resistance (See *2.)	Between coil and contacts	100 MΩ min.
	Between contacts of the same polarity	100 MΩ min.
Dielectric strength	Between coil and contacts	500 VAC 1 min
	Between contacts of the same polarity	500 VAC 1 min
Vibration resistance	Destruction	33 Hz, 45 m/s <sup>2</sup>
	Malfunction	10 to 500 Hz to 10 Hz, 45 m/s <sup>2</sup> (detection time: 10 μs)
Shock resistance	Destruction	1,000 m/s <sup>2</sup> (pulse duration: 6 ms)
	Malfunction	100 m/s <sup>2</sup> (pulse duration: 11 ms detection time: 10 μs)
Mechanical endurance (See *3.)	1,000,000 ops. min.	
Electrical endurance (See *4.)	Motor Load	25 A 0.3 mH 100,000 operations (0.2 s On/9.8 s Off)
	Resistive Load	25 A 100,000 operations (1.0 s On/1.0 s Off)
Ambient operating temperature (See *5.)	-40 to 125°C (without freezing or condensation)	
Ambient operating humidity	35% to 85% RH	
Weight	Approx. 4.0 g	Approx. 8.0 g

Note. The above values are initial values at an ambient temperature of 23°C unless otherwise specified.

- \*1. The contact resistance was measured with 1 A at 5 VDC.
- \*2. The insulation resistance was measured with a 500 VDC megohmmeter.
- \*3. The mechanical endurance was measured at a switching frequency of 18,000 operations/hr.
- \*4. Please connect N.O terminal to the +BATT side on Electrical use and connect surge suppression element in parallel with between coil based on recommended circuit.
- \*5. G8K-17R/27R/17SR/27SR supports 125°C. G8K-17UR/27UR supports 105°C.  
Please refer to the condition of carrying current and derating curve if using under the maximum ambient temperature.

Recommended circuit: (a), (b), (c)

Not-recommended circuit: (d)

Note:  
OMRON recommends coil driver circuit (b) and (c) for coil surge suppression.  
However the circuit (d) is not recommended because it may negatively affect the durability performance.

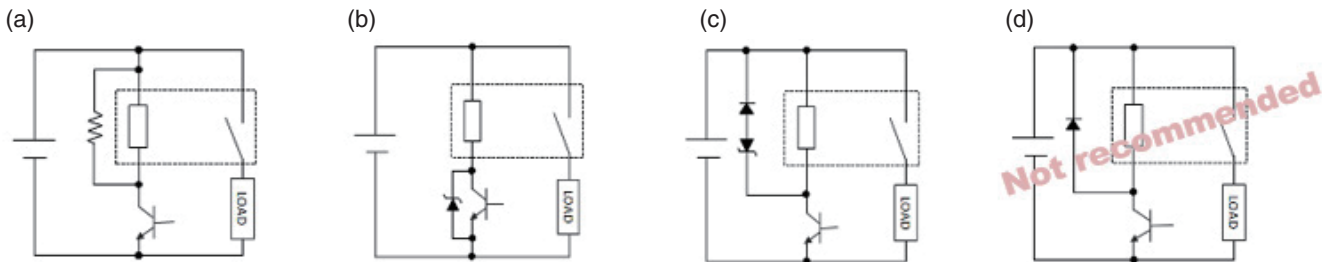

### Reference Technical Data

#### Actual Electrical performance (reference)

Model	Application	Load voltage	Inrush	Steady state	Switching off	Inductance	Ambient temperature	Required Cycles (min)
		(V)	(A)	(A)	(A)	(mH)	(°C)	Total
G8K-27SR	Front wiper	13.5	20	4.25	4.25	0.63	25	500,000
G8K-27SR	Central door lock	14		25	25	0.5	25	170,000
G8K-27SR	Anti Theft Horn	14	7.1	3.4	3.4	3	-40°C to +90°C	200,000
G8K-27R	Door Lock	16		16.5	16.5	1.48	-40°C to +85°C	100,000
G8K-27R	Door Lock	14		20	20	0.75	25	130,000
G8K-17UR	Door Lock	14			28	0.16		210,000
G8K-17UR	DC motor	16		38	38		85°C	1,000
G8K-17UR	DC motor	18		26	26		85°C	1,000

#### Must-operate Voltage and Must-release Voltage Distributions (Number of Relays × Percentage of Rated Voltage)

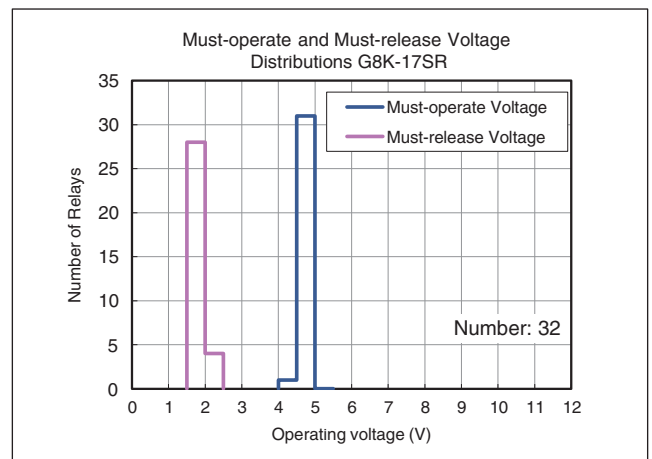
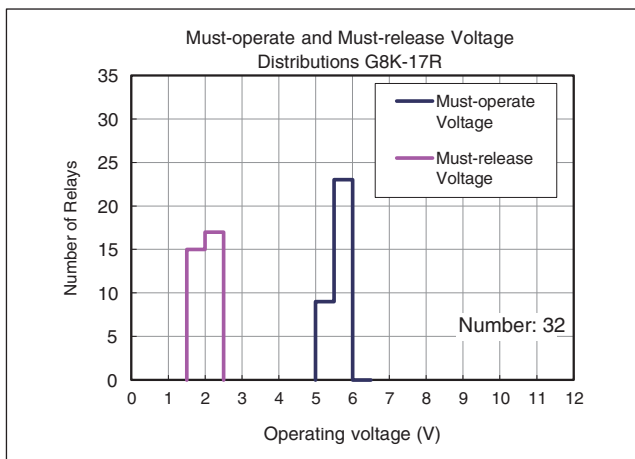

#### Time Characteristic Distributions (Number of Contacts × Time (ms))

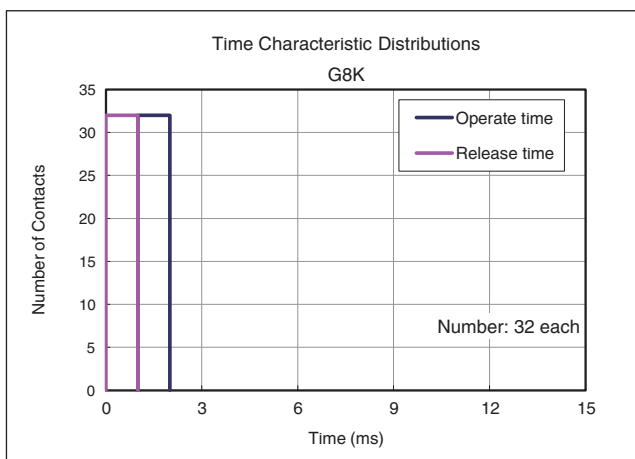

### ● Operating voltage vs ambient temperature (Cold start)

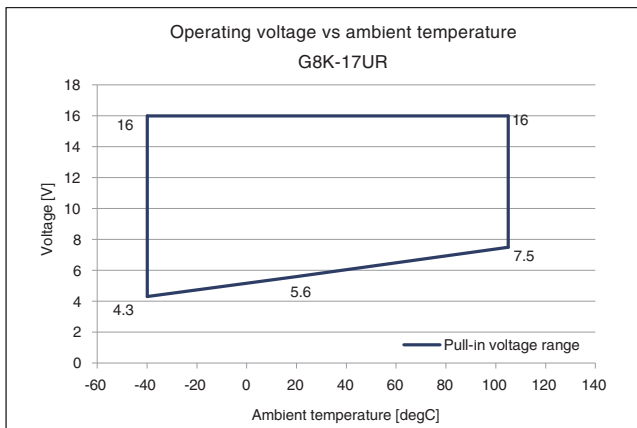
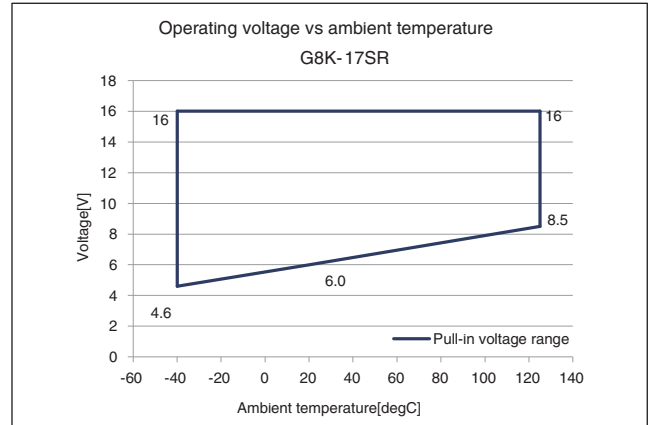
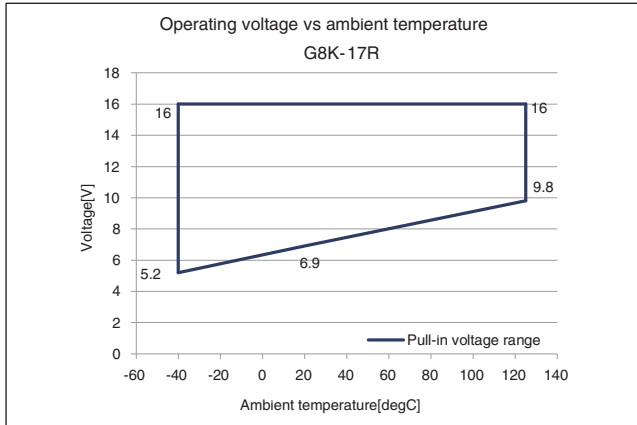

### ● Coil temperature rise [degC]

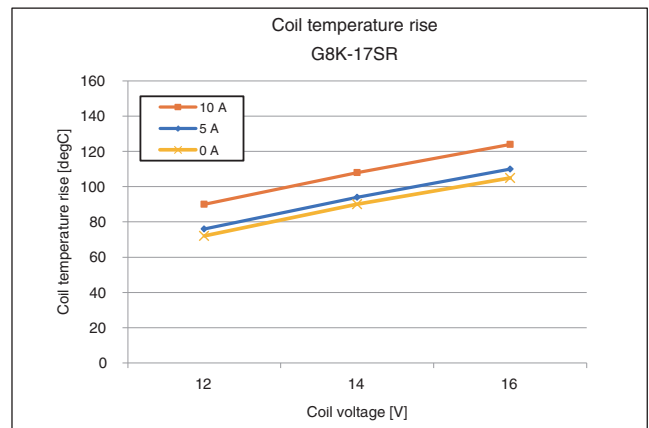
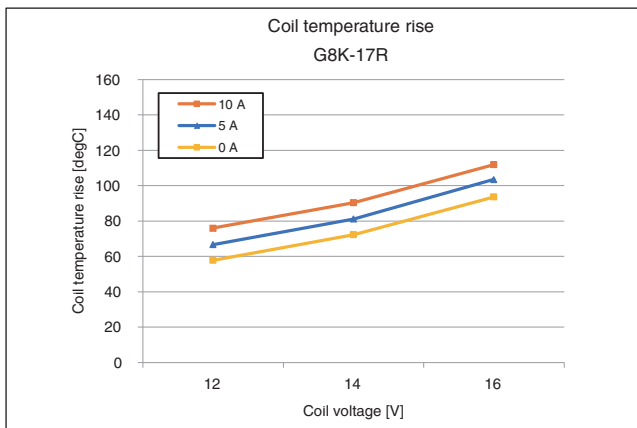

### ● Derating curve

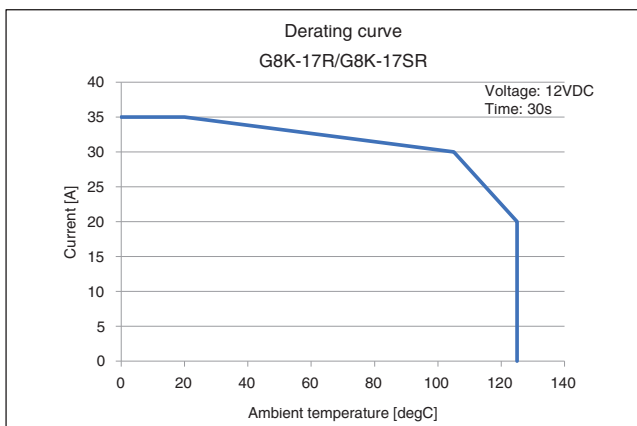

### Dimensions

**CAD Data** Please visit our website, which is noted on the last page.

(Unit: mm)

#### G8K Single

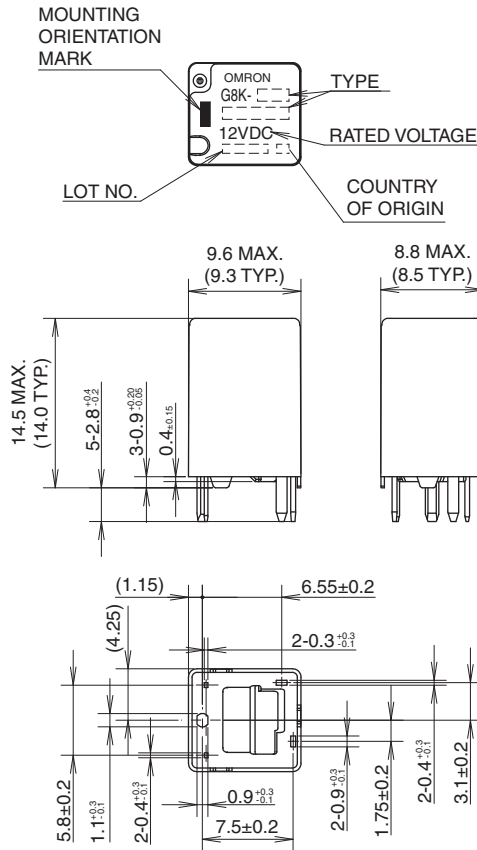

FOR REFERENCE: PCB MOUNTING HOLES (BOTTOM VIEW)

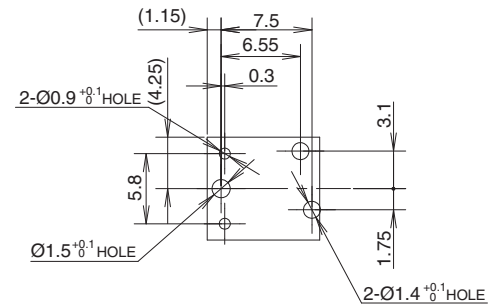

\*Please study & choose other appropriate hole diameters if confirmed the diameter values recommended above don't work with the soldering process.

TERMINAL ARRANGEMENT/  
INTERNAL CONNECTIONS  
(BOTTOM VIEW)

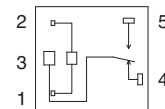

TOLERANCE UNLESS OTHERWISE SPECIFIED

LESS THAN 1mm : ±0.1mm

1 to 3mm : ±0.2mm

3mm OR MORE : ±0.3mm

**CAD Data**

#### G8K Twin

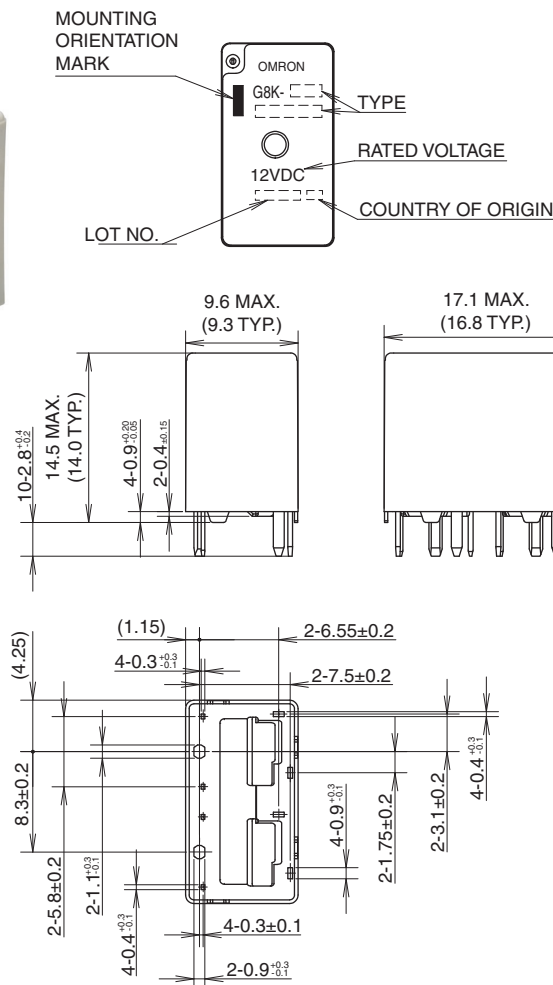

FOR REFERENCE: PCB MOUNTING HOLES (BOTTOM VIEW)

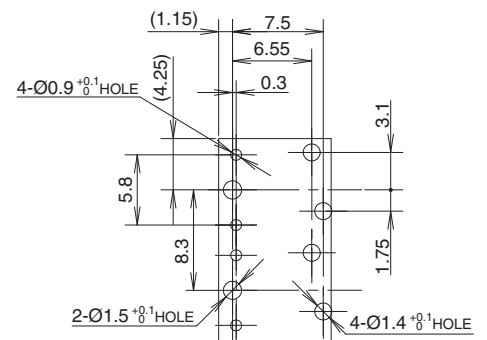

\*Please study & choose other appropriate hole diameters if confirmed the diameter values recommended above don't work with the soldering process.

TERMINAL ARRANGEMENT/  
INTERNAL CONNECTIONS  
(BOTTOM VIEW)

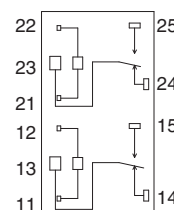

TOLERANCE UNLESS OTHERWISE SPECIFIED

LESS THAN 1mm : ±0.1mm

1 to 3mm : ±0.2mm

3mm OR MORE : ±0.3mm

**CAD Data**

### ■Precautions

- Please refer to “Safety Precautions for All Automotive Relays” for correct use.

Please check each region's Terms & Conditions by region website.

### OMRON Corporation Electronic and Mechanical Components Company

#### Regional Contact

**Americas**

<https://www.components.omron.com/>

**Asia-Pacific**

<https://ecb.omron.com.sg/>

**Korea**

<https://www.omron-ecb.co.kr/>

**Europe**

<http://components.omron.eu/>

**China**

<https://www.ecb.omron.com.cn/>

**Japan**

<https://www.omron.co.jp/ecb/>